

REALTEK

RTL8111C-GR

RTL8111C-VB-GR

RTL8111C-VC-GR

INTEGRATED GIGABIT ETHERNET CONTROLLER FOR PCI EXPRESS™ APPLICATIONS

DATASHEET

Rev. 1.5
11 January 2008
Track ID: JATR-1076-21



Realtek Semiconductor Corp.

No. 2, Innovation Road II, Hsinchu Science Park, Hsinchu 300, Taiwan

Tel.: +886-3-578-0211. Fax: +886-3-577-6047

www.realtek.com.tw

COPYRIGHT

©2008 Realtek Semiconductor Corp. All rights reserved. No part of this document may be reproduced, transmitted, transcribed, stored in a retrieval system, or translated into any language in any form or by any means without the written permission of Realtek Semiconductor Corp.

DISCLAIMER

Realtek provides this document “as is”, without warranty of any kind, neither expressed nor implied, including, but not limited to, the particular purpose. Realtek may make improvements and/or changes in this document or in the product described in this document at any time. This document could include technical inaccuracies or typographical errors.

TRADEMARKS

Realtek is a trademark of Realtek Semiconductor Corporation. Other names mentioned in this document are trademarks/registered trademarks of their respective owners.

USING THIS DOCUMENT

This document is intended for the software engineer’s reference and provides detailed programming information.

Though every effort has been made to ensure that this document is current and accurate, more information may have become available subsequent to the production of this guide. In that event, please contact your Realtek representative for additional information that may help in the development process.

REVISION HISTORY

| Revision | Release Date | Summary |
|----------|--------------|----------------------------------------------------------------------------------------------------------------------------------------------------------------------------------------------------------------------------------------------------------------------------------------------------------------------------------------------------------------|
| 1.0 | 2006/12/12 | First release. |
| 1.1 | 2007/02/09 | Changed Figure 1 Pin Assignments, page 3. Changed Table 8 Power and Ground, page 6. Removed SMBus table. Added Table 9 GPIO Pins, page 7. Changed Table 10 NC (Not Connected) Pins, page 4. Renamed VDD12 to DVDD12. |
| 1.2 | 2007/08/10 | Changed Figure 1 Pin Assignments, page 3 Changed Table 9 GPIO Pins, page 7. Added section 7 Switching Regulator, page 25. Changed Table 26 Absolute Maximum Ratings, page 31. Changed Table 27 Recommended Operating Conditions, page 31. Changed Table 30 Thermal Characteristics, page 32. Changed Table 37 Ordering Information, page 41. |
| 1.3 | 2007/09/05 | Changed Figure 19 Power Sequence, page 30 Changed Table 25 Power Sequence Parameter, page 30. |
| 1.4 | 2007/11/08 | Added Table 29 Oscillator Requirements, page 32. |
| 1.5 | 2008/01/11 | Changed Table 24 Inductor and Capacitor Parts List, page 25. Changed Table 37 Ordering Information, page 41. |

Table of Contents

| | | |
|-----------|-------------------------------------------------------------|----------|
| 1. | GENERAL DESCRIPTION | 1 |
| 2. | FEATURES | 2 |
| 3. | SYSTEM APPLICATIONS | 2 |
| 4. | PIN ASSIGNMENTS | 3 |
| 4.1. | PACKAGE IDENTIFICATION | 3 |
| 5. | PIN DESCRIPTIONS | 4 |
| 5.1. | POWER MANAGEMENT/ISOLATION | 4 |
| 5.2. | PCI EXPRESS INTERFACE | 4 |
| 5.3. | EEPROM | 5 |
| 5.4. | TRANSCEIVER INTERFACE | 5 |
| 5.5. | CLOCK | 5 |
| 5.6. | REGULATOR AND REFERENCE | 6 |
| 5.7. | LEDs | 6 |
| 5.8. | POWER AND GROUND | 6 |
| 5.9. | GPIO PINS | 7 |
| 5.10. | NC (NOT CONNECTED) PINS | 7 |
| 6. | FUNCTIONAL DESCRIPTION | 8 |
| 6.1. | PCI EXPRESS BUS INTERFACE | 8 |
| 6.1.1. | PCI Express Transmitter | 8 |
| 6.1.2. | PCI Express Receiver | 8 |
| 6.2. | LED FUNCTIONS | 8 |
| 6.2.1. | Link Monitor | 8 |
| 6.2.2. | Rx LED | 9 |
| 6.2.3. | Tx LED | 9 |
| 6.2.4. | Tx/Rx LED | 10 |
| 6.2.5. | LINK/ACT LED | 11 |
| 6.3. | PHY TRANSCEIVER | 12 |
| 6.3.1. | PHY Transmitter | 12 |
| 6.3.2. | PHY Receiver | 12 |
| 6.4. | NEXT PAGE | 13 |
| 6.5. | EEPROM INTERFACE | 13 |
| 6.6. | POWER MANAGEMENT | 14 |
| 6.7. | VITAL PRODUCT DATA (VPD) | 16 |
| 6.8. | MESSAGE SIGNED INTERRUPT (MSI) | 17 |
| 6.8.1. | MSI Capability Structure in PCI Configuration Space | 17 |
| 6.8.2. | Message Control | 18 |
| 6.8.3. | Message Address | 19 |
| 6.8.4. | Message Upper Address | 19 |
| 6.8.5. | Message Data | 19 |
| 6.9. | MSI-X | 20 |
| 6.9.1. | MSI-X Capability Structure in PCI Configuration Space | 20 |
| 6.9.2. | Message Control | 21 |
| 6.9.3. | Table Offset/BIR | 21 |
| 6.9.4. | PBA Offset/PBA BIR | 22 |
| 6.9.5. | Message Address for MSI-X Table Entries | 22 |
| 6.9.6. | Message Upper Address for MSI-X Table Entries | 22 |
| 6.9.7. | Message Data for MSI-X Table Entries | 22 |
| 6.9.8. | Vector Control for MSI-X Table Entries | 23 |

| | | |
|------------|-------------------------------------------------|-----------|
| 6.9.9. | Pending Bits for MSI-X PBA Entries..... | 23 |
| 6.10. | RECEIVE-SIDE SCALING (RSS) | 23 |
| 6.10.1. | Receive-Side Scaling (RSS) Initialization | 23 |
| 6.10.2. | RSS Operation | 24 |
| 7. | SWITCHING REGULATOR..... | 25 |
| 7.1. | PCB LAYOUT..... | 25 |
| 7.2. | INDUCTOR AND CAPACITOR PARTS LIST | 25 |
| 7.3. | MEASUREMENT CRITERIA..... | 26 |
| 7.4. | TYPICAL SWITCHING REGULATOR PCB LAYOUT | 30 |
| 7.5. | POWER SEQUENCE | 30 |
| 8. | CHARACTERISTICS..... | 31 |
| 8.1. | ABSOLUTE MAXIMUM RATINGS | 31 |
| 8.2. | RECOMMENDED OPERATING CONDITIONS | 31 |
| 8.3. | CRYSTAL REQUIREMENTS..... | 31 |
| 8.4. | OSCILLATOR REQUIREMENTS | 32 |
| 8.5. | THERMAL CHARACTERISTICS..... | 32 |
| 8.6. | DC CHARACTERISTICS | 32 |
| 8.7. | AC CHARACTERISTICS | 33 |
| 8.7.1. | Serial EEPROM Interface Timing..... | 33 |
| 8.8. | PCI EXPRESS BUS PARAMETERS | 34 |
| 8.8.1. | Differential Transmitter Parameters | 34 |
| 8.8.2. | Differential Receiver Parameters | 35 |
| 8.8.3. | REFCLK Parameters..... | 35 |
| 8.8.4. | Auxiliary Signal Timing Parameters | 39 |
| 9. | MECHANICAL DIMENSIONS..... | 40 |
| 10. | ORDERING INFORMATION | 41 |

List of Tables

| | |
|---------------------------------------------------------------|----|
| TABLE 1. POWER MANAGEMENT/ISOLATION | 4 |
| TABLE 2. PCI EXPRESS INTERFACE | 4 |
| TABLE 3. EEPROM | 5 |
| TABLE 4. TRANSCEIVER INTERFACE | 5 |
| TABLE 5. CLOCK | 5 |
| TABLE 6. REGULATOR AND REFERENCE | 6 |
| TABLE 7. LEDs | 6 |
| TABLE 8. POWER AND GROUND | 6 |
| TABLE 9. GPIO PINS | 7 |
| TABLE 10. NC (NOT CONNECTED) PINS | 7 |
| TABLE 11. EEPROM INTERFACE | 13 |
| TABLE 12. MESSAGE CONTROL | 18 |
| TABLE 13. MESSAGE ADDRESS | 19 |
| TABLE 14. MESSAGE UPPER ADDRESS | 19 |
| TABLE 15. MESSAGE DATA | 19 |
| TABLE 16. MESSAGE CONTROL | 21 |
| TABLE 17. TABLE OFFSET/BIR | 21 |
| TABLE 18. PBA OFFSET/PBA BIR | 22 |
| TABLE 19. MESSAGE ADDRESS FOR MSI-X TABLE ENTRIES | 22 |
| TABLE 20. MESSAGE UPPER ADDRESS FOR MSI-X TABLE ENTRIES | 22 |
| TABLE 21. MESSAGE DATA FOR MSI-X TABLE ENTRIES | 22 |
| TABLE 22. VECTOR CONTROL FOR MSI-X TABLE ENTRIES | 23 |
| TABLE 23. PENDING BITS FOR MSI-X PBA ENTRIES | 23 |
| TABLE 24. INDUCTOR AND CAPACITOR PARTS LIST | 25 |
| TABLE 25. POWER SEQUENCE PARAMETER | 30 |
| TABLE 26. ABSOLUTE MAXIMUM RATINGS | 31 |
| TABLE 27. RECOMMENDED OPERATING CONDITIONS | 31 |
| TABLE 28. CRYSTAL REQUIREMENTS | 31 |
| TABLE 29. OSCILLATOR REQUIREMENTS | 32 |
| TABLE 30. THERMAL CHARACTERISTICS | 32 |
| TABLE 31. DC CHARACTERISTICS | 32 |
| TABLE 32. EEPROM ACCESS TIMING PARAMETERS | 33 |
| TABLE 33. DIFFERENTIAL TRANSMITTER PARAMETERS | 34 |
| TABLE 34. DIFFERENTIAL RECEIVER PARAMETERS | 35 |
| TABLE 35. REFCLK PARAMETERS | 35 |
| TABLE 36. AUXILIARY SIGNAL TIMING PARAMETERS | 39 |
| TABLE 37. ORDERING INFORMATION | 41 |

List of Figures

| | |
|-------------------------------------------------------------------------------------|----|
| FIGURE 1. PIN ASSIGNMENTS | 3 |
| FIGURE 2. RX LED | 9 |
| FIGURE 3. TX LED | 9 |
| FIGURE 4. Tx/Rx LED | 10 |
| FIGURE 5. LINK/ACT LED | 11 |
| FIGURE 6. MSI CAPABILITY STRUCTURE | 17 |
| FIGURE 7. MSI-X CAPABILITY STRUCTURE | 20 |
| FIGURE 8. MSI-X TABLE STRUCTURE | 20 |
| FIGURE 9. MSI-X PBA STRUCTURE | 20 |
| FIGURE 10. SWITCHING REGULATOR ILLUSTRATION | 25 |
| FIGURE 11. INPUT VOLTAGE OVERSHOOT <4V (GOOD) | 26 |
| FIGURE 12. INPUT VOLTAGE OVERSHOOT >4V (BAD) | 26 |
| FIGURE 13. CERAMIC 22 μ F 1210 (X5R) (GOOD) | 27 |
| FIGURE 14. CERAMIC 22 μ F 0805 (Y5V) (BAD) | 27 |
| FIGURE 15. ELECTROLYTIC 100 μ F (RIPPLE TOO HIGH) | 28 |
| FIGURE 16. 4R7GTSD32 (GOOD) | 29 |
| FIGURE 17. 1 μ H BEAD (BAD) | 29 |
| FIGURE 18. TYPICAL SWITCHING REGULATOR PCB LAYOUT | 30 |
| FIGURE 19. POWER SEQUENCE | 30 |
| FIGURE 20. SERIAL EEPROM INTERFACE TIMING | 33 |
| FIGURE 21. SINGLE-ENDED MEASUREMENT POINTS FOR ABSOLUTE CROSS POINT AND SWING | 37 |
| FIGURE 22. SINGLE-ENDED MEASUREMENT POINTS FOR DELTA CROSS POINT | 37 |
| FIGURE 23. SINGLE-ENDED MEASUREMENT POINTS FOR RISE AND FALL TIME MATCHING | 37 |
| FIGURE 24. DIFFERENTIAL MEASUREMENT POINTS FOR DUTY CYCLE AND PERIOD | 38 |
| FIGURE 25. DIFFERENTIAL MEASUREMENT POINTS FOR RISE AND FALL TIME | 38 |
| FIGURE 26. DIFFERENTIAL MEASUREMENT POINTS FOR RINGBACK | 38 |
| FIGURE 27. REFERENCE CLOCK SYSTEM MEASUREMENT POINT AND LOADING | 39 |
| FIGURE 28. AUXILIARY SIGNAL TIMING | 39 |

1. General Description

The Realtek RTL8111C-GR/RTL8111C-VB-GR/RTL8111C-VC-GR Gigabit Ethernet controller combines a triple-speed IEEE 802.3 compliant Media Access Controller (MAC) with a triple-speed Ethernet transceiver, PCI Express bus controller, and embedded memory. With state-of-the-art DSP technology and mixed-mode signal technology, the RTL8111C offers high-speed transmission over CAT 5 UTP cable or CAT 3 UTP (10Mbps only) cable. Functions such as Crossover Detection and Auto-Correction, polarity correction, adaptive equalization, cross-talk cancellation, echo cancellation, timing recovery, and error correction are implemented to provide robust transmission and reception capability at high speeds.

The RTL8111C is compliant with the IEEE 802.3u specification for 10/100Mbps Ethernet and the IEEE 802.3ab specification for 1000Mbps Ethernet. It also supports an auxiliary power auto-detect function, and will auto-configure related bits of the PCI power management registers in PCI configuration space.

Advanced Configuration Power management Interface (ACPI)—power management for modern operating systems that are capable of Operating System-directed Power Management (OSPM)—is supported to achieve the most efficient power management possible. PCI MSI (Message Signaled Interrupt) and MSI-X are also supported.

In addition to the ACPI feature, remote wake-up (including AMD Magic Packet™ and Microsoft® Wake-up frame) is supported in both ACPI and APM (Advanced Power Management) environments. To support WOL from a deep power down state (e.g., D3cold, i.e., main power is off and only auxiliary exists), the auxiliary power source must be able to provide the needed power for the RTL8111C.

The RTL8111C is fully compliant with Microsoft® NDIS5, NDIS6(IPv4, IPv6, TCP, UDP) Checksum and Segmentation Task-offload (Large send and Giant send) features, and supports IEEE 802 IP Layer 2 priority encoding and IEEE 802.1Q Virtual bridged Local Area Network (VLAN). The above features contribute to lowering CPU utilization, especially benefiting performance when in operation on a network server.

The RTL8111C supports Receive Side Scaling (RSS) to hash incoming TCP connections and load-balance received data processing across multiple CPUs. RSS improves the number of transactions per second and number of connections per second, for increased network throughput.

The device also features inter-connect PCI Express technology. PCI Express is a high-bandwidth, low pin count, serial, interconnect technology that offers significant improvements in performance over conventional PCI and also maintains software compatibility with existing PCI infrastructure. The device embeds an adaptive equalizer in the PCIe PHY for ease of system integration and excellent link quality. The equalizer enables the length of the PCB traces to reach 40 inches.

The RTL8111C is suitable for multiple market segments and emerging applications, such as desktop, mobile, workstation, server, communications platforms, and embedded applications.

Note: RTL8111C-GR, RTL8111C-VB-GR, and RTL8111C-VC-GR differences are listed in section 10 Ordering Information, page 41.

2. Features

- Integrated 10/100/1000 transceiver
- Auto-Negotiation with Next Page capability
- Supports PCI Express™ 1.1
- Supports pair swap/polarity/skew correction
- Crossover Detection & Auto-Correction
- Wake-on-LAN and remote wake-up support
- Microsoft® NDIS5, NDIS6 Checksum Offload (IPv4, IPv6, TCP, UDP) and Segmentation Task-offload (Large send and Giant send) support
- Supports Full Duplex flow control (IEEE 802.3x)
- Fully compliant with IEEE 802.3, IEEE 802.3u, IEEE 802.3ab
- Supports IEEE 802.1P Layer 2 Priority Encoding
- Supports IEEE 802.1Q VLAN tagging
- Serial EEPROM
- Transmit/Receive on-chip buffer support
- Supports power down/link down power saving
- Built-in switching regulator
- Supports PCI MSI (Message Signaled Interrupt) and MSI-X
- Supports Receive-Side Scaling (RSS)
- 64-pin QFN package (Green package)
- Embeds an adaptive equalizer in PCI Express PHY (PCB traces can reach up to 40 inches)

3. System Applications

- PCI Express™ Gigabit Ethernet on Motherboard, Notebook, or Embedded system

4. Pin Assignments

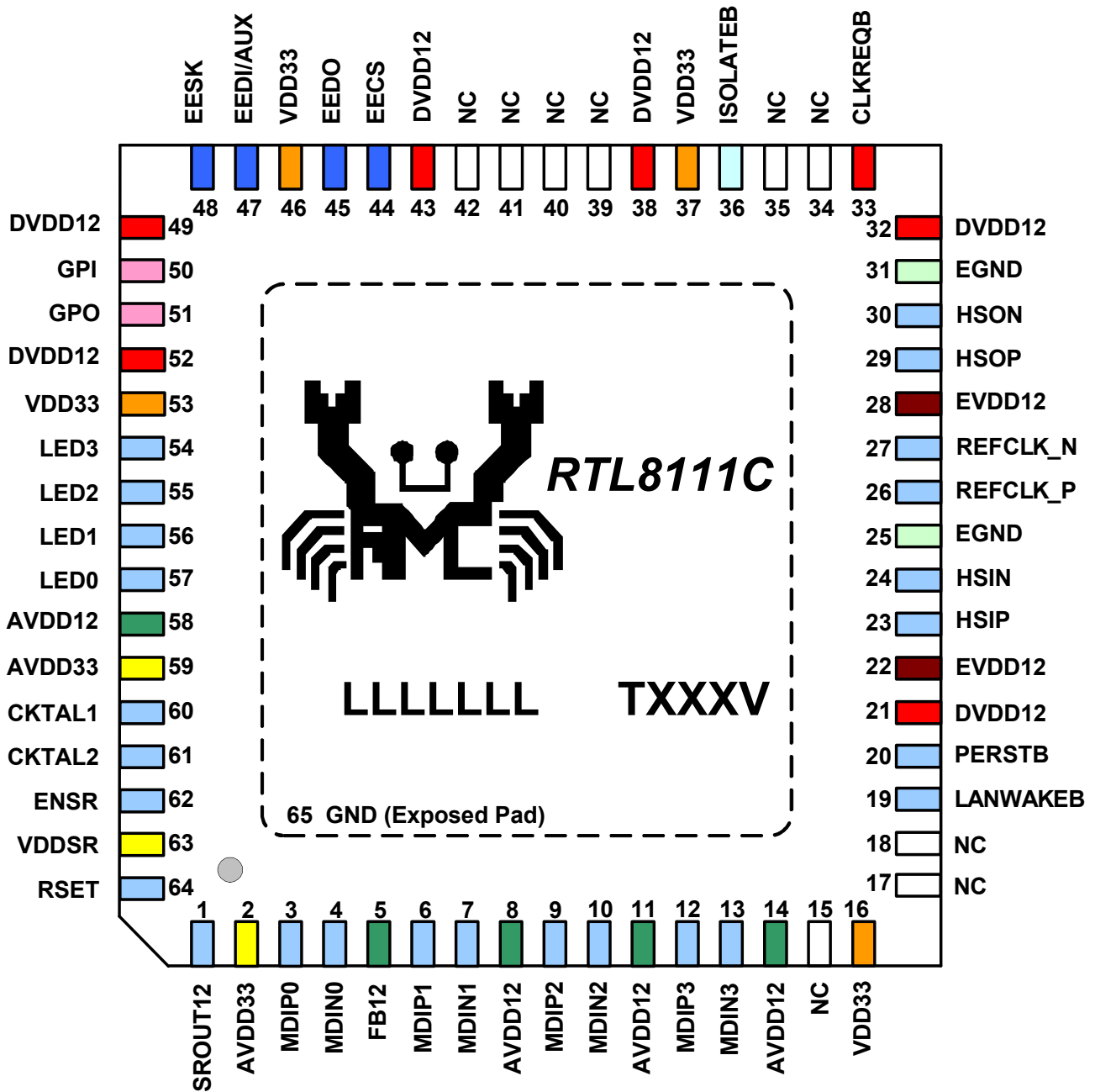

Figure 1. Pin Assignments

4.1. Package Identification

‘Green’ package is indicated by a ‘G’ in the location marked ‘T’ in Figure 1. The version number is shown in the location marked ‘V’.

5. Pin Descriptions

The signal type codes below are used in the following tables:

I: Input

S/T/S: Sustained Tri-State

O: Output

O/D: Open Drain

T/S: Tri-State Bi-Directional Input/Output

5.1. Power Management/Isolation

Table 1. Power Management/Isolation

| Symbol | Type | Pin No | Description |
|----------|------|--------|-----------------------------------------------------------------------------------------------------------------------------------------------------------------------------------------------------------------------------------------------|
| LANWAKEB | O/D | 19 | Power Management Event: Open drain, active low. Used to reactivate the PCI Express slot's main power rails and reference clocks. |
| ISOLATEB | I | 36 | Isolate Pin: Active low. Used to isolate the RTL8111C from the PCI Express bus. The RTL8111C will not drive its PCI Express outputs (excluding LANWAKEB) and will not sample its PCI Express input as long as the Isolate pin is asserted. |

5.2. PCI Express Interface

Table 2. PCI Express Interface

| Symbol | Type | Pin No | Description |
|----------|------|--------|-----------------------------------------------------------------------------------------------------------------------------------------------------------------------------------------------------------------------------------|
| REFCLK_P | I | 26 | PCI Express Differential Reference Clock Source: 100MHz \pm 300ppm. |
| REFCLK_N | I | 27 | |
| HSOP | O | 29 | PCI Express Transmit Differential Pair. |
| HSOIN | O | 30 | |
| HSIP | I | 23 | PCI Express Receive Differential Pair. |
| HSIN | I | 24 | |
| PERSTB | I | 20 | PCI Express Reset Signal: Active low. When the PERSTB is asserted at power-on state, the RTL8111C returns to a pre-defined reset state and is ready for initialization and configuration after the de-assertion of the PERSTB. |
| CLKREQB | O/D | 33 | Reference Clock Request Signal. This signal is used by the RTL8111C to request starting of the PCI Express reference clock. |

5.3. EEPROM

Table 3. EEPROM

| Symbol | Type | Pin No | Description |
|----------|------|--------|--------------------------------------------------------------------------------------------------------------------------------------------------------------------------------------------------------------------------------------------------------------------------------------------------------------------------------------------------------------------------------------|
| EESK | O | 48 | Serial Data Clock. |
| EEDI/AUX | OI | 47 | EEDI: Output to serial data input pin of EEPROM. AUX: Input pin to detect if Aux. Power exists or not on initial power-on. This pin should be connected to EEPROM. To support wakeup from ACPI D3cold or APM power-down, this pin must be pulled high to Aux. Power via a resistor. If this pin is not pulled high to Aux. Power, the RTL8111C assumes that no Aux. Power exists. |
| EEDO | I | 45 | Input from Serial Data Output Pin of EEPROM. |
| EECS | O | 44 | EECS: EEPROM chip select. |

5.4. Transceiver Interface

Table 4. Transceiver Interface

| Symbol | Type | Pin No | Description |
|--------|------|--------|-----------------------------------------------------------------------------------------------------------------------------------|
| MDIP0 | IO | 3 | In MDI mode, this is the first pair in 1000Base-T, i.e., the BI_DA+/- pair, and is the transmit pair in 10Base-T and 100Base-TX. |
| MDIN0 | IO | 4 | |
| MDIP1 | IO | 6 | In MDI mode, this is the second pair in 1000Base-T, i.e., the BI_DB+/- pair, and is the transmit pair in 10Base-T and 100Base-TX. |
| MDIN1 | IO | 7 | |
| MDIP2 | IO | 9 | In MDI mode, this is the third pair in 1000Base-T, i.e., the BI_DC+/- pair. |
| MDIN2 | IO | 10 | |
| MDIP3 | IO | 12 | In MDI mode, this is the fourth pair in 1000Base-T, i.e., the BI_DD+/- pair. |
| MDIN3 | IO | 13 | |

5.5. Clock

Table 5. Clock

| Symbol | Type | Pin No | Description |
|--------|------|--------|----------------------------------|
| CKTAL1 | I | 60 | Input of 25MHz Clock Reference. |
| CKTAL2 | O | 61 | Output of 25MHz Clock Reference. |

5.6. Regulator and Reference

Table 6. Regulator and Reference

| Symbol | Type | Pin No | Description |
|---------|-------|--------|-----------------------------------------------------------------------|
| SROUT12 | O | 1 | Switching Regulator 1.2V Output. Connect to 5 μ H inductor. |
| FB12 | I | 5 | Feedback Pin for Switching Regulator. |
| ENSR | I | 62 | 3.3V: Enable switching regulator. 0V: Disable switching regulator. |
| VDDSR | Power | 63 | Digital 3.3V Power Supply for Switching Regulator. |
| RSET | I | 64 | Reference. External resistor reference. |

5.7. LEDs

Table 7. LEDs

| Symbol | Type | Pin No | Description | | | | | | | | | | | | | | | | | | | | | | | | | | | | | |
|---------|----------|---------------------|-----------------------------------------------------------------------------------------------------------------------------------------------------------------------------------------------------------------------------------------------------------------------------------------------------------------------------------------------------------------------------------------------------------------------------------------------------------------------------------------------------------------------------------------------|------------------|-----------------|----|----|----|------|-------|-------|----|------------|------|---------|---------------------|------|-----------------|------|--------|------------|----|------|------|----------|----------|------|------------------|--|--|--|--|
| LED0 | O | 57 | <table border="1"> <thead> <tr> <th>LEDS1-0</th> <th>00</th> <th>01</th> <th>10</th> <th>11</th> </tr> </thead> <tbody> <tr> <td>LED0</td> <td>Tx/Rx</td> <td>Tx/Rx</td> <td>Tx</td> <td>LINK10/ACT</td> </tr> <tr> <td>LED1</td> <td>LINK100</td> <td>LINK10/100/ 1000</td> <td>LINK</td> <td>LINK100/ ACT</td> </tr> <tr> <td>LED2</td> <td>LINK10</td> <td>LINK10/100</td> <td>Rx</td> <td>FULL</td> </tr> <tr> <td>LED3</td> <td>LINK1000</td> <td>LINK1000</td> <td>FULL</td> <td>LINK1000/ ACT</td> </tr> </tbody> </table> | LEDS1-0 | 00 | 01 | 10 | 11 | LED0 | Tx/Rx | Tx/Rx | Tx | LINK10/ACT | LED1 | LINK100 | LINK10/100/ 1000 | LINK | LINK100/ ACT | LED2 | LINK10 | LINK10/100 | Rx | FULL | LED3 | LINK1000 | LINK1000 | FULL | LINK1000/ ACT | | | | |
| LEDS1-0 | 00 | 01 | | 10 | 11 | | | | | | | | | | | | | | | | | | | | | | | | | | | |
| LED0 | Tx/Rx | Tx/Rx | | Tx | LINK10/ACT | | | | | | | | | | | | | | | | | | | | | | | | | | | |
| LED1 | LINK100 | LINK10/100/ 1000 | | LINK | LINK100/ ACT | | | | | | | | | | | | | | | | | | | | | | | | | | | |
| LED2 | LINK10 | LINK10/100 | | Rx | FULL | | | | | | | | | | | | | | | | | | | | | | | | | | | |
| LED3 | LINK1000 | LINK1000 | FULL | LINK1000/ ACT | | | | | | | | | | | | | | | | | | | | | | | | | | | | |
| LED1 | O | 56 | | | | | | | | | | | | | | | | | | | | | | | | | | | | | | |
| LED2 | O | 55 | | | | | | | | | | | | | | | | | | | | | | | | | | | | | | |
| LED3 | O | 54 | | | | | | | | | | | | | | | | | | | | | | | | | | | | | | |
| | | | | | | | | | | | | | | | | | | | | | | | | | | | | | | | | |

Note 1: During power down mode, the LED signals are logic high.

Note 2: LED_{S1-0}'s initial value comes from the 93C46. If there is no 93C46, the default value of the (LED_{S1}, LED_{S0})=(1, 1).

5.8. Power and Ground

Table 8. Power and Ground

| Symbol | Type | Pin No | Description |
|--------|-------|------------------------|----------------------------|
| VDD33 | Power | 16, 37, 46, 53 | Digital 3.3V Power Supply. |
| DVDD12 | Power | 21, 32, 38, 43, 49, 52 | Digital 1.2V Power Supply. |
| AVDD12 | Power | 8, 11, 14, 58 | Analog 1.2V Power Supply. |
| EVDD12 | Power | 22, 28 | Analog 1.2V Power Supply. |
| AVDD33 | Power | 2, 59 | Analog 3.3V Power Supply. |
| EGND | Power | 25, 31 | Analog Ground. |
| GND | Power | 65 | Ground (Exposed Pad). |

Note: Refer to the most updated schematic circuit for correct configuration.

5.9. GPIO Pins

Table 9. GPIO Pins

| Symbol | Type | Pin No | Description |
|--------|------|--------|---------------------------------------------------------------------------------------------------------------------|
| GPI | I | 50 | General Purpose Input Pin. |
| GPO | O | 51 | General Purpose Output Pin. This pin reflects the link up or link down state. High: Link up Low: Link down |

5.10. NC (Not Connected) Pins

Table 10. NC (Not Connected) Pins

| Symbol | Type | Pin No | Description |
|--------|------|------------------------------------|----------------|
| NC | - | 15, 17, 18, 34, 35, 39, 40, 41, 42 | Not Connected. |

6. Functional Description

6.1. *PCI Express Bus Interface*

The RTL8111C is compliant with PCI Express Base Specification Revision 1.1, and runs at a 2.5GHz signaling rate with X1 link width, i.e., one transmit and one receive differential pair. The RTL8111C supports four types of PCI Express messages: interrupt messages, error messages, power management messages, and hot-plug messages. To ease PCB layout constraints, PCI Express lane polarity reversal and link reversal are also supported.

6.1.1. PCI Express Transmitter

The RTL8111C's PCI Express block receives digital data from the Ethernet interface and performs data scrambling with Linear Feedback Shift Register (LFSR) and 8B/10B coding technology into 10-bit code groups. Data scrambling is used to reduce the possibility of electrical resonance on the link, and 8B/10B coding technology is used to benefit embedded clocking, error detection, and DC balance by adding an overhead to the system through the addition of 2 extra bits. The data code groups are passed through its serializer for packet framing. The generated 2.5Gbps serial data is transmitted onto the PCB trace to its upstream device via a differential driver.

6.1.2. PCI Express Receiver

The RTL8111C's PCI Express block receives 2.5Gbps serial data from its upstream device to generate parallel data. The receiver's PLL circuits are re-synchronized to maintain bit and symbol lock. Through 8B/10B decoding technology and data de-scrambling, the original digital data is recovered and passed to the RTL8111C's internal Ethernet MAC to be transmitted onto the Ethernet media.

6.2. *LED Functions*

The RTL8111C supports four LED signals in four different configurable operation modes. The following sections describe the various LED actions.

6.2.1. Link Monitor

The Link Monitor senses link integrity, such as LINK10, LINK100, LINK1000, LINK10/100/1000, LINK10/ACT, LINK100/ACT, or LINK1000/ACT. Whenever link status is established, the specific link LED pin is driven low. Once a cable is disconnected, the link LED pin is driven high, indicating that no network connection exists.

6.2.2. Rx LED

In 10/100/1000Mbps mode, blinking of the Rx LED indicates that receive activity is occurring.

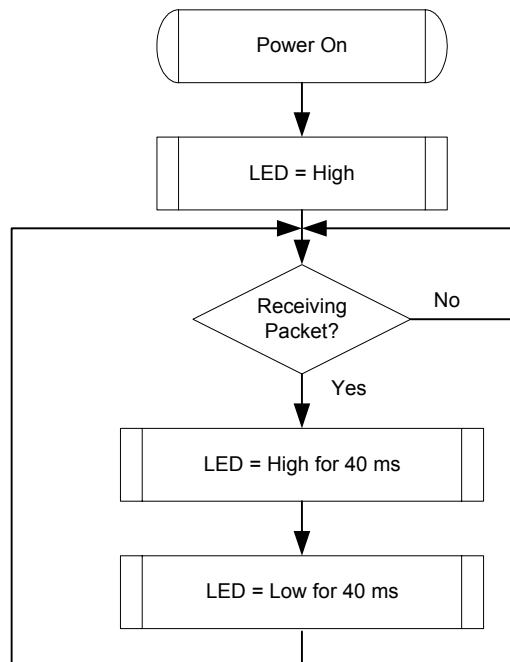

Figure 2. Rx LED

6.2.3. Tx LED

In 10/100/1000Mbps mode, blinking of the Tx LED indicates that transmit activity is occurring.

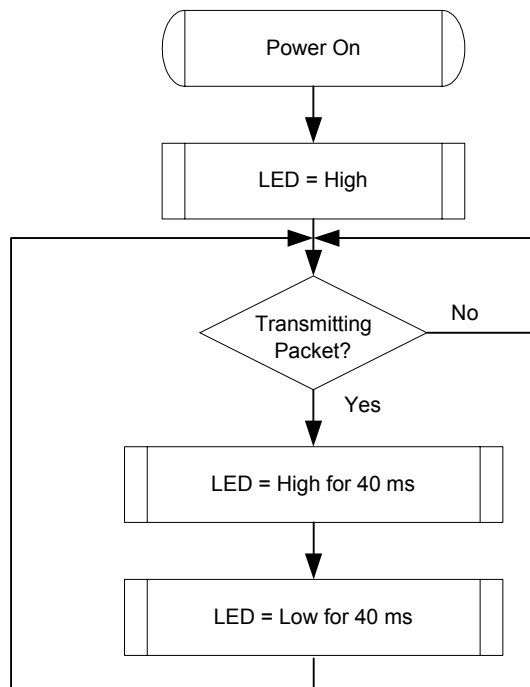

Figure 3. Tx LED

6.2.4. Tx/Rx LED

In 10/100/1000Mbps mode, blinking of the Tx/Rx LED indicates that both transmit and receive activity is occurring.

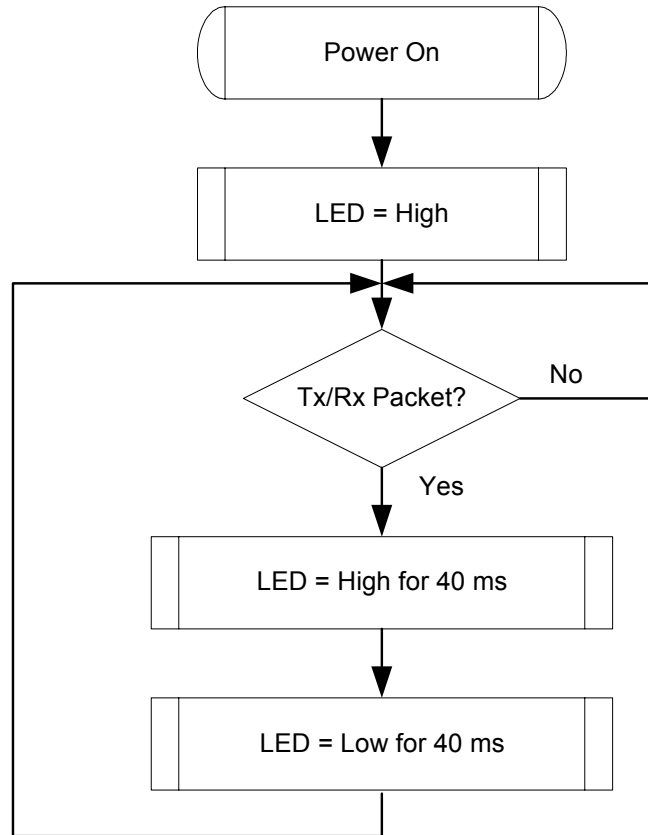

Figure 4. Tx/Rx LED

6.2.5. LINK/ACT LED

In 10/100/1000Mbps mode, blinking of the LINK/ACT LED indicates that the RTL8111C is linked and operating properly. When this LED is high for extended periods, it indicates that a link problem exists.

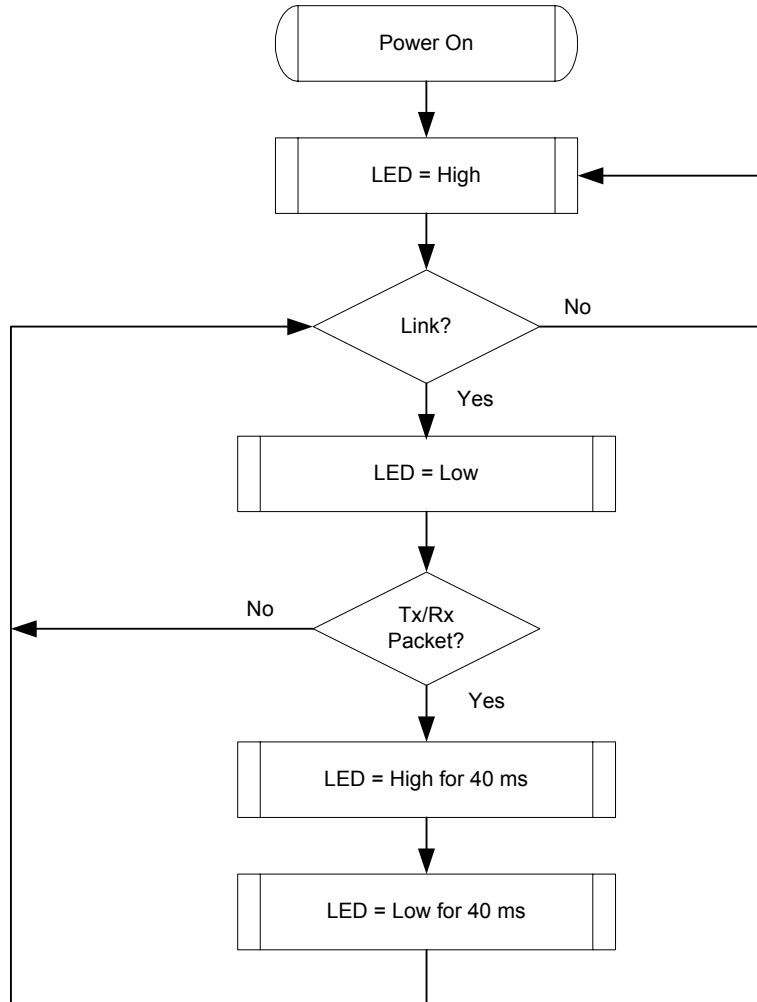

Figure 5. LINK/ACT LED

6.3. PHY Transceiver

6.3.1. PHY Transmitter

Based on state-of-the-art DSP technology and mixed-mode signal processing technology, the RTL8111C operates at 10/100/1000Mbps over standard CAT.5 UTP cable (100/1000Mbps), and CAT.3 UTP cable (10Mbps).

GMII (1000Mbps) Mode

The RTL8111C's PCS layer receives data bytes from the MAC through the GMII interface and performs the generation of continuous code-groups through 4D-PAM5 coding technology. These code groups are passed through a waveform-shaping filter to minimize EMI effect, and are transmitted onto the 4-pair CAT5 cable at 125MBaud/s through a D/A converter.

MII (100Mbps) Mode

The transmitted 4-bit nibbles (TXD[3:0]) from the MAC, clocked at 25MHz (TXC), are converted into 5B symbol code through 4B/5B coding technology, then through scrambling and serializing, are converted to 125Mhz NRZ and NRZI signals. After that, the NRZI signals are passed to the MLT3 encoder, then to the D/A converter and transmitted onto the media.

MII (10Mbps) Mode

The transmitted 4-bit nibbles (TXD[3:0]) from the MAC, clocked at 2.5MHz (TXC), are serialized into 10Mbps serial data. The 10Mbps serial data is converted into a Manchester-encoded data stream and is transmitted onto the media by the D/A converter.

6.3.2. PHY Receiver

GMII (1000Mbps) Mode

Input signals from the media pass through the sophisticated on-chip hybrid circuit to separate the transmitted signal from the input signal for effective reduction of near-end echo. Afterwards, the received signal is processed with state-of-the-art technology, e.g., adaptive equalization, BLW (Baseline Wander) correction, cross-talk cancellation, echo cancellation, timing recovery, error correction, and 4D-PAM5 decoding. Then, the 8-bit-wide data is recovered and is sent to the GMII interface at a clock speed of 125MHz. The Rx MAC retrieves the packet data from the receive MII/GMII interface and sends it to the Rx Buffer Manager.

MII (100Mbps) Mode

The MLT3 signal is processed with an ADC, equalizer, BLW (Baseline Wander) correction, timing recovery, MLT3 and NRZI decoder, descrambler, 4B/5B decoder, and is then presented to the MII interface in 4-bit-wide nibbles at a clock speed of 25MHz.

MII (10Mbps) Mode

The received differential signal is converted into a Manchester-encoded stream first. Next, the stream is processed with a Manchester decoder and is de-serialized into 4-bit-wide nibbles. The 4-bit nibbles are presented to the MII interface at a clock speed of 2.5MHz.

6.4. Next Page

If 1000Base-T mode is advertised, three additional Next Pages are automatically exchanged between the two link partners. Users can set PHY Reg4.15 to 1 to manually exchange extra Next Pages via Reg7 and Reg8 as defined in IEEE 802.3ab.

6.5. EEPROM Interface

The RTL8111C requires the attachment of an external EEPROM. The 93C46/93C56 is a 1K-bit/2K-bit EEPROM. The EEPROM interface permits the RTL8111C to read from, and write data to, an external serial EEPROM device.

Values in the external EEPROM allow default fields in PCI configuration space and I/O space to be overridden following a power-on or software EEPROM auto-load command. The RTL8111C will auto-load values from the EEPROM. If the EEPROM is not present, the RTL8111C initialization uses default values for the appropriate Configuration and Operational Registers. Software can read and write to the EEPROM using bit-bang accesses via the 9346CR Register, or using PCI VPD (Vital Product Data). The interface consists of EESK, EECS, EEDO, and EEDI.

The correct EEPROM (i.e., 93C46/93C56) must be used in order to ensure proper LAN function.

Table 11. EEPROM Interface

| EEPROM | Description |
|----------|------------------------------------------------------------------------------------------------------------------------------------------------------------------------------------------------------------------------------------------------------------------------------------------------------------------------------------------|
| EECS | 93C46/93C56 Chip Select. |
| EESK | EEPROM Serial Data Clock. |
| EEDI/Aux | Input Data Bus/Input Pin to Detect Whether Aux. Power Exists on Initial Power-On. This pin should be connected to EEPROM. To support wakeup from ACPI D3cold or APM power-down, this pin must be pulled high to Aux. Power via a resistor. If this pin is not pulled high to Aux. Power, the RTL8111C assumes that no Aux. Power exists. |
| EEDO | Output Data Bus. |

6.6. Power Management

The RTL8111C is compliant with ACPI (Rev 1.0, 1.0b, 2.0), PCI Power Management (Rev 1.1), PCI Express Active State Power Management (ASPM), and Network Device Class Power Management Reference Specification (V1.0a), such as to support an Operating System-directed Power Management (OSPM) environment.

The RTL8111C can monitor the network for a Wakeup Frame, a Magic Packet, and notify the system via a PCI Express Power Management Event (PME) Message, Beacon, or LANWAKEB pin when such a packet or event occurs. Then the system can be restored to a normal state to process incoming jobs.

When the RTL8111C is in power down mode (D1 ~ D3):

- The Rx state machine is stopped. The RTL8111C monitors the network for wakeup events such as a Magic Packet and Wakeup Frame in order to wake up the system. When in power down mode, the RTL8111C will not reflect the status of any incoming packets in the ISR register and will not receive any packets into the Rx on-chip buffer.
- The on-chip buffer status and packets that have already been received into the Rx on-chip buffer before entering power down mode are held by the RTL8111C.
- Transmission is stopped. PCI Express transactions are stopped. The Tx on-chip buffer is held.
- After being restored to D0 state, the RTL8111C transmits data that was not moved into the Tx on-chip buffer during power down mode. Packets that were not transmitted completely last time are re-transmitted.

The D3cold_support_PME bit (bit15, PMC register) and the Aux_I_b2:0 bits (bit8:6, PMC register) in PCI configuration space depend on the existence of Aux power. If aux. power is absent, the above 4 bits are all 0 in binary.

Example:

If EEPROM D3c_support_PME = 1:

- If aux. power exists, then PMC in PCI config space is the same as EEPROM PMC (if EEPROM PMC = C3 FF, then PCI PMC = C3 FF)
- If aux. power is absent, then PMC in PCI config space is the same as EEPROM PMC except the above 4 bits are all 0's (if EEPROM PMC = C3 FF, then PCI PMC = 03 7E)

In the above case, if wakeup support is desired when main power is off, it is suggested that the EEPROM PMC be set to C3 FF (Realtek EEPROM default value).

If EEPROM D3c_support_PME = 0:

- If aux. power exists, then PMC in PCI config space is the same as EEPROM PMC (if EEPROM PMC = C3 7F, then PCI PMC = C3 7F)
- If aux. power is absent, then PMC in PCI config space is the same as EEPROM PMC except the above 4 bits are all 0's (if EEPROM PMC = C3 7F, then PCI PMC = 03 7E)

In the above case, if wakeup support is not desired when main power is off, it is suggested that the EEPROM PMC be set to 03 7E.

Magic Packet Wakeup occurs only when the following conditions are met:

- The destination address of the received Magic Packet is acceptable to the RTL8111C, e.g., a broadcast, multicast, or unicast packet addressed to the current RTL8111C adapter.
- The received Magic Packet does not contain a CRC error.
- The Magic bit (CONFIG3#5) is set to 1, the PMEn bit (CONFIG1#0) is set to 1, and the corresponding wake-up method (message, beacon, or LANWAKEB) can be asserted in the current power state.
- The Magic Packet pattern matches, i.e., $6 * FFh + MISC$ (can be none) + $16 * DID$ (Destination ID) in any part of a valid Ethernet packet.

A Wakeup Frame event occurs only when the following conditions are met:

- The destination address of the received Wakeup Frame is acceptable to the RTL8111C, e.g., a broadcast, multicast, or unicast address to the current RTL8111C adapter.
- The received Wakeup Frame does not contain a CRC error.
- The PMEn bit (CONFIG1#0) is set to 1.
- The 16-bit CRC^A of the received Wakeup Frame matches the 16-bit CRC of the sample Wakeup Frame pattern given by the local machine's OS. Or, the RTL8111C is configured to allow direct packet wakeup, e.g., a broadcast, multicast, or unicast network packet.

Note: 16-bit CRC: The RTL8111C supports eight long wakeup frames (covering 128 mask bytes from offset 0 to 127 of any incoming network packet).

The corresponding wake-up method (message or LANWAKEB) is asserted only when the following conditions are met:

- The PMEn bit (bit0, CONFIG1) is set to 1.
- The PME_En bit (bit8, PMCSR) in PCI Configuration Space is set to 1.
- The RTL8111C may assert the corresponding wake-up method (message or LANWAKEB) in the current power state or in isolation state, depending on the PME_Support (bit15-11) setting of the PMC register in PCI Configuration Space.
- A Magic Packet, LinkUp, or Wakeup Frame has been received.
- Writing a 1 to the PME_Status (bit15) of the PMCSR register in the PCI Configuration Space clears this bit and causes the RTL8111C to stop asserting the corresponding wake-up method (message or LANWAKEB) (if enabled).

When the RTL8111C is in power down mode, e.g., D1-D3, the IO and MEM accesses to the RTL8111C are disabled. After a PERSTB assertion, the device's power state is restored to D0 automatically if the original power state was D3_{cold}. There is almost no hardware delay at the device's power state transition. When in ACPI mode, the device does not support PME (Power Management Enable) from D0 (this is the Realtek default setting of the PMC register auto-loaded from EEPROM). The setting may be changed from the EEPROM, if required.

6.7. Vital Product Data (VPD)

Bit 31 of the Vital Product Data (VPD) capability structure in the RTL8111C's PCI Configuration Space is used to issue VPD read/write commands and is also a flag used to indicate whether the transfer of data between the VPD data register and the 93C46/93C56/93C66 has completed or not.

Write VPD register: (write data to the 93C46/93C56/93C66)

Set the flag bit to 1 at the same time the VPD address is written to write VPD data to EEPROM. When the flag bit is reset to 0 by the RTL8111C, the VPD data (4 bytes per VPD access) has been transferred from the VPD data register to EEPROM.

Read VPD register: (read data from the 93C46/93C56/93C66)

Reset the flag bit to 0 at the same time the VPD address is written to retrieve VPD data from EEPROM. When the flag bit is set to 1 by the RTL8111C, the VPD data (4 bytes per VPD access) has been transferred from EEPROM to the VPD data register.

Note1: Refer to the PCI 2.3 Specifications for further information.

Note2: The VPD address must be a DWORD-aligned address as defined in the PCI 2.3 Specifications. VPD data is always consecutive 4-byte data starting from the VPD address specified.

Note3: Realtek reserves offset 60h to 7Fh in EEPROM mainly for VPD data to be stored.

Note4: The VPD function of the RTL8111C is designed to be able to access the full range of the 93C46/93C56/93C66 EEPROM.

6.8. Message Signaled Interrupt (MSI)

6.8.1. MSI Capability Structure in PCI Configuration Space

Capability Structure for 32-bit Message Address

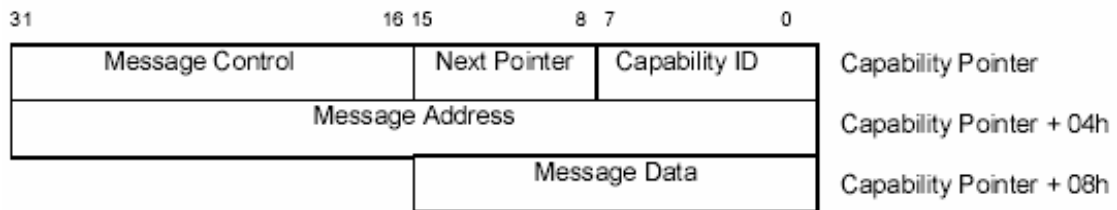

Capability Structure for 64-bit Message Address

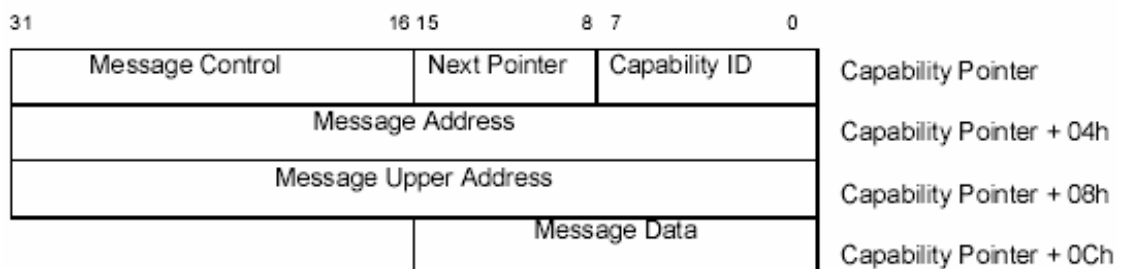

Figure 6. MSI Capability Structure

6.8.2. Message Control

Table 12. Message Control

| Bits | RW | Field | Description | | | | | | | | | | | | | | | | | | |
|----------|----------------------------|--------------------------|-----------------------------------------------------------------------------------------------------------------------------------------------------------------------------------------------------------------------------------------------------------------------------------------------------------------------------------------------------------------------------------------------------------------------------------------------------------------------------------------------------------------------------------------------------------------------------------------------------------------------------------------------------------|----------|----------------------------|-----|---|--------|----------|-----|---|-----|---|-----|----|-----|----|-----|----------|-----|----------|
| 15:8 | RO | Reserved | Reserved. Always return 0 | | | | | | | | | | | | | | | | | | |
| 7 | RO | 64-bit Address Capable | 1: The RTL8111C is capable of generating a 64-bit message address. 0: The RTL8111C is NOT capable of generating a 64-bit message address. This bit is read only and the RTL8111C is set to 1. | | | | | | | | | | | | | | | | | | |
| 6:4 | RW | Multiple Message Enable | System software (e.g., BIOS, OS) indicates to the RTL8111C the number of allocated messages/vectors (equal to or less than the number of requested messages/vectors). This field after PCI reset is '000'. <table border="1" data-bbox="708 618 1398 954"> <thead> <tr> <th>Encoding</th> <th>Number of Messages/Vectors</th> </tr> </thead> <tbody> <tr><td>000</td><td>1</td></tr> <tr><td>001</td><td>2</td></tr> <tr><td>010</td><td>4</td></tr> <tr><td>011</td><td>8</td></tr> <tr><td>100</td><td>16</td></tr> <tr><td>101</td><td>32</td></tr> <tr><td>110</td><td>Reserved</td></tr> <tr><td>111</td><td>Reserved</td></tr> </tbody> </table> | Encoding | Number of Messages/Vectors | 000 | 1 | 001 | 2 | 010 | 4 | 011 | 8 | 100 | 16 | 101 | 32 | 110 | Reserved | 111 | Reserved |
| Encoding | Number of Messages/Vectors | | | | | | | | | | | | | | | | | | | | |
| 000 | 1 | | | | | | | | | | | | | | | | | | | | |
| 001 | 2 | | | | | | | | | | | | | | | | | | | | |
| 010 | 4 | | | | | | | | | | | | | | | | | | | | |
| 011 | 8 | | | | | | | | | | | | | | | | | | | | |
| 100 | 16 | | | | | | | | | | | | | | | | | | | | |
| 101 | 32 | | | | | | | | | | | | | | | | | | | | |
| 110 | Reserved | | | | | | | | | | | | | | | | | | | | |
| 111 | Reserved | | | | | | | | | | | | | | | | | | | | |
| 3:1 | RO | Multiple Message Capable | Indication to system software (e.g., BIOS, OS) of the number of RTL8111C requested vectors. The RTL8111C supports only one vector messages/vectors. <table border="1" data-bbox="708 1077 1398 1189"> <thead> <tr> <th>Encoding</th> <th>Number of Messages/Vectors</th> </tr> </thead> <tbody> <tr><td>000</td><td>1</td></tr> <tr><td>Others</td><td>Reserved</td></tr> </tbody> </table> | Encoding | Number of Messages/Vectors | 000 | 1 | Others | Reserved | | | | | | | | | | | | |
| Encoding | Number of Messages/Vectors | | | | | | | | | | | | | | | | | | | | |
| 000 | 1 | | | | | | | | | | | | | | | | | | | | |
| Others | Reserved | | | | | | | | | | | | | | | | | | | | |
| 0 | RW | MSI Enable | 1: Enable MSI (Also the INTx pin is disabled automatically, MSI and INTx are mutually exclusive), this bit is set by system software. 0: Disable MSI (Default value after power-on or PCI reset) | | | | | | | | | | | | | | | | | | |

6.8.3. Message Address

Table 13. Message Address

| Bits | RW | Field | Description |
|-------|----|-----------------|---------------------------------------------------------------------------------------------------------|
| 31:02 | RW | Message Address | System-Specified Message/Vector Address. Low DWORD aligned address for MSI memory write transaction. |
| 01:00 | RO | Reserved | Always Return '00'. This bit is read only. |

6.8.4. Message Upper Address

Table 14. Message Upper Address

| Bits | RW | Field | Description |
|-------|----|-----------------------|------------------------------------------------------------------------------------------------------------------------------------------------------------------------------------------------------------------------------------------------------------------------------------------------------------------------------------------------------------------------------------------------------------------------|
| 31:00 | RW | Message Upper Address | System-Specified Message/Vector Upper Address. Upper 32 bits of a 64-bit message/vector address. This register is effective only when the DAC function is enabled, i.e., 64-bit addressing is enabled; bit7 in Message Control register is set. If the contents of this register are 0, the RTL8111C only performs 32-bit addressing for the memory write of the messages/vectors. This bit is read/write. |

6.8.5. Message Data

Table 15. Message Data

| Bits | RW | Field | Description |
|-------|----|--------------|------------------------------------------------------------------------------------------------------------------------------------------------------------------|
| 15:00 | RW | Message Data | If the Message Enable bit is set, the message/vector data is driven onto the lower word of the memory write transaction's data phase. This bit is read/write. |

6.9. MSI-X

6.9.1. MSI-X Capability Structure in PCI Configuration Space

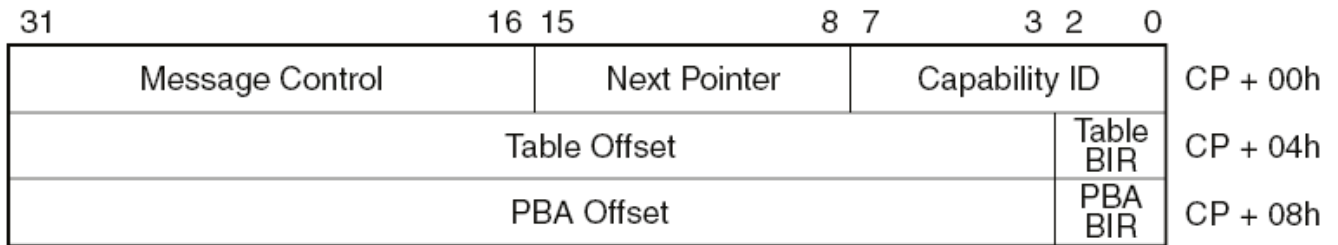

Figure 7. MSI-X Capability Structure

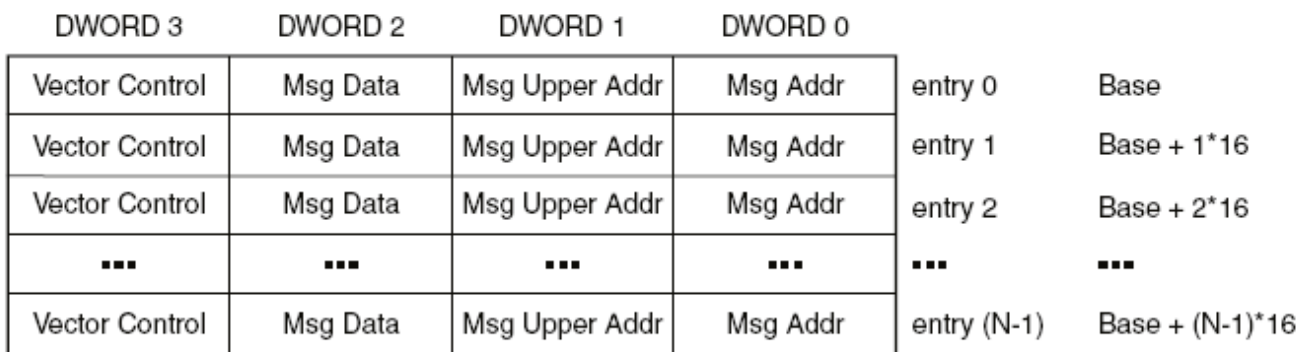

Figure 8. MSI-X Table Structure

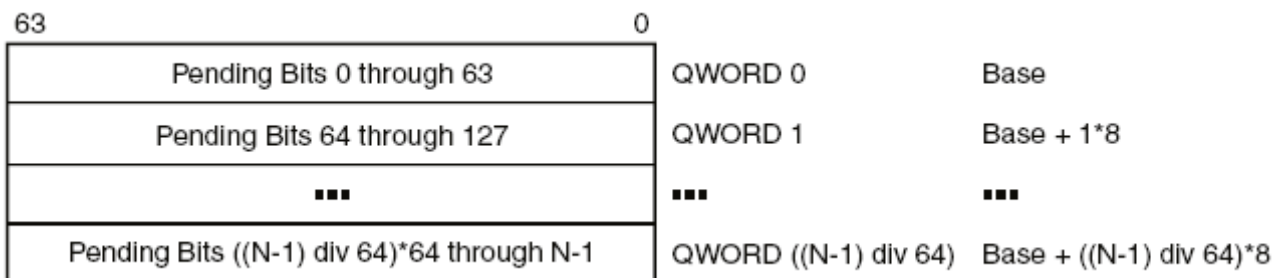

Figure 9. MSI-X PBA Structure

6.9.2. Message Control

Table 16. Message Control

| Bits | RW | Field | Description |
|-------|----|---------------|--------------------------------------------------------------------------------------------------------------------------------------------------------------------------------------------------------------------------------------------------------------------------------------------------------------------------------------------------------------------------------------------------------------------------------------------------------------------------------------------------|
| 15 | RW | MSI-X Enable | If 1 and the MSI Enable bit in the MSI Message Control register is 0, the function is permitted to use MSI-X to request service and is prohibited from using its INTx# pin. System configuration software sets this bit to enable MSI-X. A device driver is prohibited from writing this bit to mask a function's service request. If 0, the function is prohibited from using MSI-X to request service. This bit's state after reset is 0 (MSI-X is disabled). This bit is read/write. |
| 14 | RW | Function Mask | If 1, all of the vectors associated with the function are masked, regardless of their per-vector Mask bit states. If 0, each vector's Mask bit determines whether the vector is masked or not. Setting or clearing the MSI-X Function Mask bit has no effect on the state of the per-vector Mask bits. This bit's state after reset is 0 (unmasked). This bit is read/write. |
| 13:11 | RO | Reserved | Always Returns 0 on a Read. A write operation has no effect. |
| 10:00 | RO | Table Size | System software reads this field to determine the MSI-X Table Size N, which is encoded as N-1. The RTL8111C value is '0000000001', indicating a table size of 2. |

6.9.3. Table Offset/BIR

Table 17. Table Offset/BIR

| Bits | RW | Field | Description | | | | | | | | | | | | | | | | | | |
|-----------|-----------------------|--------------|-------------------------------------------------------------------------------------------------------------------------------------------------------------------------------------------------------------------------------------------------------------------------------------------------------------------------------------------------------------------------------------------------------------------------------------------------------------------------------------------------------------------------------------------------------------------------------------------------------------------------------------------------------------------------------------------------------------------------------------------------------------------------------------------------------------------------------------------------------------------------------------------------|-----------|-----------------------|---|-----|---|-----|---|-----|---|-----|---|-----|---|-----|---|----------|---|----------|
| 31:03 | RW | Table Offset | Used as an offset from the address contained by one of the function's Base Address registers to point to the base of the MSI-X Table. The lower 3 BIR bits are masked off (set to zero) by software to form a 32bit QWORD-aligned offset. This field is read only. | | | | | | | | | | | | | | | | | | |
| 02:00 | RO | BIR | Indicates which one of a function's Base Address registers, located beginning at 10h in Configuration Space, is used to map the function's MSI-X Table into Memory Space. <table border="1" data-bbox="646 1370 1396 1706"> <thead> <tr> <th>BIR Value</th> <th>Base Address Register</th> </tr> </thead> <tbody> <tr> <td>0</td> <td>10h</td> </tr> <tr> <td>1</td> <td>14h</td> </tr> <tr> <td>2</td> <td>18h</td> </tr> <tr> <td>3</td> <td>1Ch</td> </tr> <tr> <td>4</td> <td>20h</td> </tr> <tr> <td>5</td> <td>24h</td> </tr> <tr> <td>6</td> <td>Reserved</td> </tr> <tr> <td>7</td> <td>Reserved</td> </tr> </tbody> </table> <p>For a 64-bit Base Address register, the BIR indicates the lower DWORD. With PCI-to-PCI bridges, BIR values 2 through 5 are also reserved. The function's Base Address registers of RTL8111C located beginning at 20h. This field is read only.</p> | BIR Value | Base Address Register | 0 | 10h | 1 | 14h | 2 | 18h | 3 | 1Ch | 4 | 20h | 5 | 24h | 6 | Reserved | 7 | Reserved |
| BIR Value | Base Address Register | | | | | | | | | | | | | | | | | | | | |
| 0 | 10h | | | | | | | | | | | | | | | | | | | | |
| 1 | 14h | | | | | | | | | | | | | | | | | | | | |
| 2 | 18h | | | | | | | | | | | | | | | | | | | | |
| 3 | 1Ch | | | | | | | | | | | | | | | | | | | | |
| 4 | 20h | | | | | | | | | | | | | | | | | | | | |
| 5 | 24h | | | | | | | | | | | | | | | | | | | | |
| 6 | Reserved | | | | | | | | | | | | | | | | | | | | |
| 7 | Reserved | | | | | | | | | | | | | | | | | | | | |

6.9.4. PBA Offset/PBA BIR

Table 18. PBA Offset/PBA BIR

| Bits | RW | Field | Description |
|-------|----|------------|--------------------------------------------------------------------------------------------------------------------------------------------------------------------------------------------------------------------------------------------------------------------------------|
| 31:03 | RO | PBA Offset | Used as an offset from the address contained by one of the function's Base Address registers to point to the base of the MSI-X PBA. The lower 3 PBA BIR bits are masked off (set to zero) by software to form a 32-bit QWORD-aligned offset. This field is read only. |
| 02:00 | RO | PBA BIR | Indicates which one of a function's Base Address registers, located beginning at 10h in Configuration Space, is used to map the function's MSI-X PBA into Memory Space. The PBA BIR value definitions are identical to those for the MSI-X Table BIR. This field is read only. |

6.9.5. Message Address for MSI-X Table Entries

Table 19. Message Address for MSI-X Table Entries

| Bits | RW | Field | Description |
|-------|----|-----------------|---------------------------------------------------------------------------------------------------------------------------------------------------------------------------------------------------------------------------------------------|
| 31:02 | RW | Message Address | System-Specified Message Lower Address. For MSI-X messages, the contents of this field from an MSI-X Table entry specifies the lower portion of the DWORD aligned address for the memory write transaction. This field is read/write. |
| 01:00 | RW | Message Address | For proper DWORD alignment, software must always write zeroes to these two bits; otherwise the result is undefined. The state of these bits after reset must be 0. These bits are permitted to be read only or read/write. |

6.9.6. Message Upper Address for MSI-X Table Entries

Table 20. Message Upper Address for MSI-X Table Entries

| Bits | RW | Field | Description |
|-------|----|-----------------------|---------------------------------------------------------------------------|
| 31:00 | RW | Message Upper Address | System-Specified Message Upper Address Bits. This field is read/write. |

6.9.7. Message Data for MSI-X Table Entries

Table 21. Message Data for MSI-X Table Entries

| Bits | RW | Field | Description |
|-------|----|--------------|----------------------------------------------------------------------------------------------------------------------------------------------------------------------------------------------------------------------------------------------------------------------------------------------|
| 31:00 | RW | Message Data | System-Specified Message Data. For MSI-X messages, the contents of this field are taken from an MSI-X Table entry. In contrast to message data used for MSI messages, the low-order message data bits in MSI-X messages are not modified by the function. This field is read/write. |

6.9.8. Vector Control for MSI-X Table Entries

Table 22. Vector Control for MSI-X Table Entries

| Bits | RW | Field | Description |
|-------|----|----------|-----------------------------------------------------------------------------------------------------------------------------------------------------------------------------------------------------------------------------------------------------------------------------------------------------------------------------------------------|
| 31:01 | RW | Reserved | After reset, the state of these bits must be 0. However, for potential future use, software must preserve the value of these reserved bits when modifying the value of other Vector Control bits. If software modifies the value of these reserved bits, the result is undefined. |
| 00 | RW | Mask Bit | When this bit is set, the function is prohibited from sending a message using this MSI-X Table entry. However, any other MSI-X Table entries programmed with the same vector will still be capable of sending an equivalent message unless they are also masked. This bit's state after reset is 1 (entry is masked). This bit is read/write. |

6.9.9. Pending Bits for MSI-X PBA Entries

Table 23. Pending Bits for MSI-X PBA Entries

| Bits | RW | Field | Description |
|-------|----|--------------|----------------------------------------------------------------------------------------------------------------------------------------------------------------------------------------------------------------------------------------------------------------------------------------------------------------------------------------------------------------------------------------------------------------------------------------------------------------------------------------------------|
| 63:00 | RW | Pending Bits | For each Pending Bit that is set, the function has a pending message for the associated MSI-X Table entry. Pending bits that have no associated MSI-X Table entry are reserved. After reset, the state of reserved Pending bits must be 0. Software should never write, and should only read Pending Bits. If software writes to Pending Bits, the result is undefined. Each Pending Bit's state after reset is 0 (no message pending). These bits are permitted to be read only or read/write. |

6.10. Receive-Side Scaling (RSS)

The RTL8111C is compliant with the new Network Driver Interface Specification (NDIS) 6.0 Receive-Side Scaling (RSS) technology for the Microsoft Windows family of operating systems. RSS allows packet receive-processing from a network adapter to be balanced across the number of available computer processors, increasing performance on multi CPU platforms.

6.10.1. Receive-Side Scaling (RSS) Initialization

During RSS initialization, the Windows operating system will inform the RTL8111C to store the following parameters: hash function, hash type, hash bits, indirection table, BaseCPUNumber, and the secret hash key.

Hash Function

The default hash function is the Toeplitz hash function.

Hash Type

The hash types indicate which field of the packet needs to be hashed to get the hash result. There are several combinations of these fields, mainly, TCP/IPv4, IPv4, TCP/IPv6, IPv6, and IPv6 extension headers.

- TCP/IPv4 requires hash calculations over the IPv4 source address, the IPv4 destination address, the source TCP port and the destination TCP port.
- IPv4 requires hash calculations over the IPv4 source address and the IPv4 destination address.
- TCP/IPv6 requires hash calculations over the IPv6 source address, the IPv6 destination address, the source TCP port and the destination TCP port.
- IPv6 requires hash calculations over the IPv6 source address and the IPv6 destination address
(*Note: The RTL8111C does not support the IPv6 extension header hash type in RSS.*)

Hash Bits

Hash bits are used to index the hash result into the indirection table

Indirection Table

The Indirection Table stores values that are added to the BaseCPUNumber to enable RSS interrupts to be restricted from some CPUs. The OS will update the Indirection Table to rebalance the load.

BaseCPUNumber

The lowest number CPU to use for RSS. BaseCPUNumber is added to the result of the indirection table lookup.

Secret hash key

The key used in the Toeplitz function. For different hash types, the key size is different.

6.10.2. RSS Operation

After the parameters are set, the RTL8111C will start hash calculation on each incoming packet and forward each packet to its correct queue according to the hash result. If the incoming packet is not in the hash type, it will be forwarded to the primary queue. The hash result plus the BaseCPUNumber will be indexed into the indirection table to get the correct CPU number. The RTL8111C uses three methods to inform the system of incoming packets: inline interrupt, MSI, and MSIX. Periodically the OS will update the indirection table to rebalance the load across the CPUs.

7. Switching Regulator

The RTL8111C incorporates a state-of-the-art switching regulator which requires a well-designed PCB layout in order to achieve good power efficiency and lower the output voltage ripple and input overshoot.

7.1. PCB Layout

- The input 3.3V power trace connected to pin 63 (VDDSR) should be wider than 40mils.
- The bulk de-coupling capacitors (C82 and C83) should be placed within 200mils (0.5cm) of pin 63 to prevent input voltage overshoot.
- The output power trace out of pin 1 (SROUT12) should be wider than 60mils.
- Keep L20 within 200mils (0.5cm) of pin1.
- Keep C18 and C19 within 200mils (0.5cm) of L20 to ensure stable output power and better power efficiency.
- Both C18 and C82 are strongly recommended to be ceramic capacitors.

Note: Violation of the above rules will damage the IC.

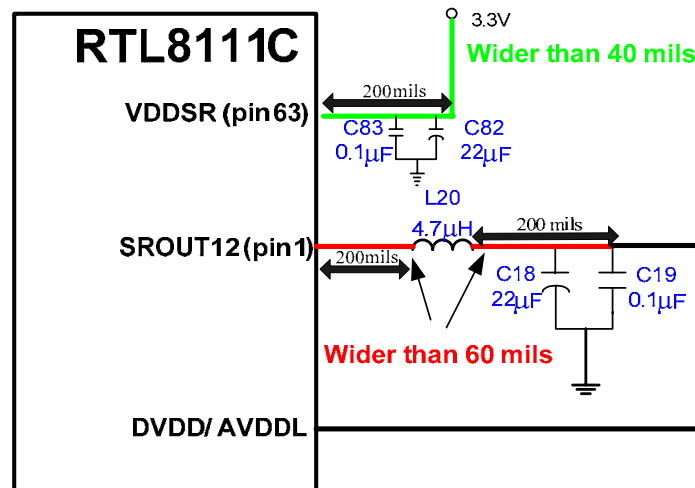

Figure 10. Switching Regulator Illustration

7.2. Inductor and Capacitor Parts List

Table 24. Inductor and Capacitor Parts List

| Inductor Type | Q at 500KHz | ESR at 500KHz (MΩ) | Max I (mA) | Output Ripple (mV) |
|--------------------------------|-------------|--------------------|--------------------|---------------------|
| 4R7GTSD32 (best efficiency) | 57.15 | 281 | 1100 | 12.6 |
| 6R8GTSD32 | 67.35 | 313 | 900 | 12 |
| 6R8GTSD53 | 59.7 | 375 | 1510 | 10.4 |
| Capacitor Type | Capacitance | ESR at 500KHz (MΩ) | Output Ripple (mV) | Load Transient (mV) |
| 22µF 1210 TDK | 21.5µF | 24.25 | 9.6 | 81.0 |
| 22µF 1210 X5R | 22.15µF | 24.90 | 10.4 | 73.0 |

Note: Capacitors (C18 & C82) are suggested to be ceramic due to their low ESR value.

7.3. Measurement Criteria

In order for the switching regulator to operate properly, the input and output voltage measurement criteria must be met. From the input side, the voltage overshoot cannot exceed 4V; otherwise the chip may be damaged. Note that the voltage signal must be measured directly at Pin 63, not at the capacitor. In order to reduce the input voltage overshoot, the C82 and C83 must be placed close to Pin 63. The following figures show what a good input voltage and a bad one look like.

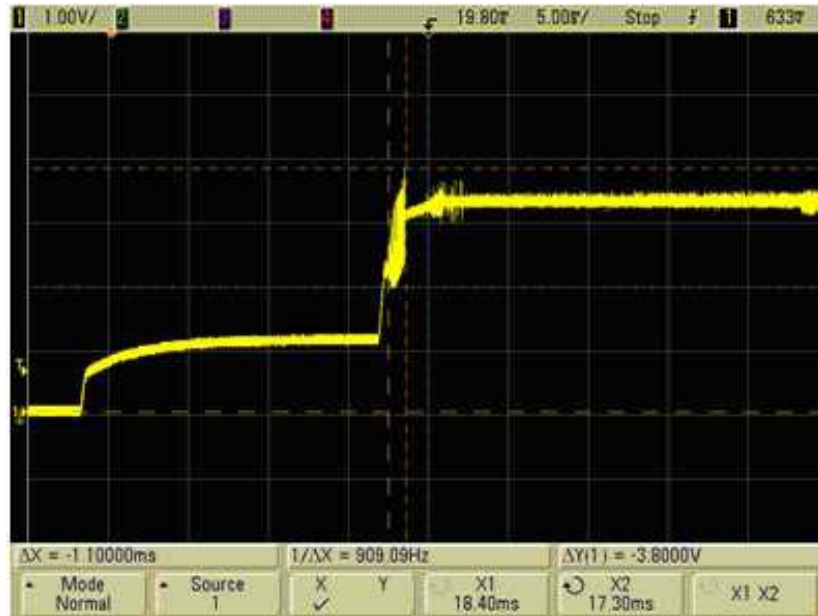

Figure 11. Input Voltage Overshoot <4V (Good)

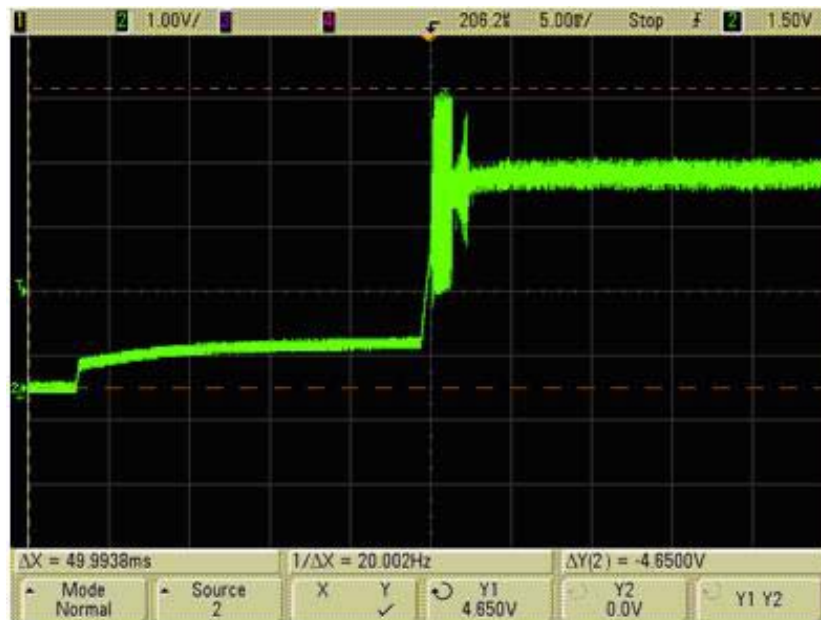

Figure 12. Input Voltage Overshoot >4V (Bad)

From the output side measured at Pin 1, the voltage ripple must be within 100mV. Choosing different types and values of output capacitor (C18, C19) and power inductor (L20) will seriously affect the efficiency and output voltage ripple of switching regulators. The following figures show the effects of different types of capacitors on the switching regulator's output voltage.

The blue square wave signal (top row) is measured at the output of SROUT12 (Pin1) before the power inductor (L20). The yellow signal (second row) is measured after the power inductor (L20), and shows there is a voltage ripple. The green signal (lower row) is the current. Data in the following figures was measured at gigabit speed.



Figure 13. Ceramic 22 μ F 1210 (X5R) (Good)

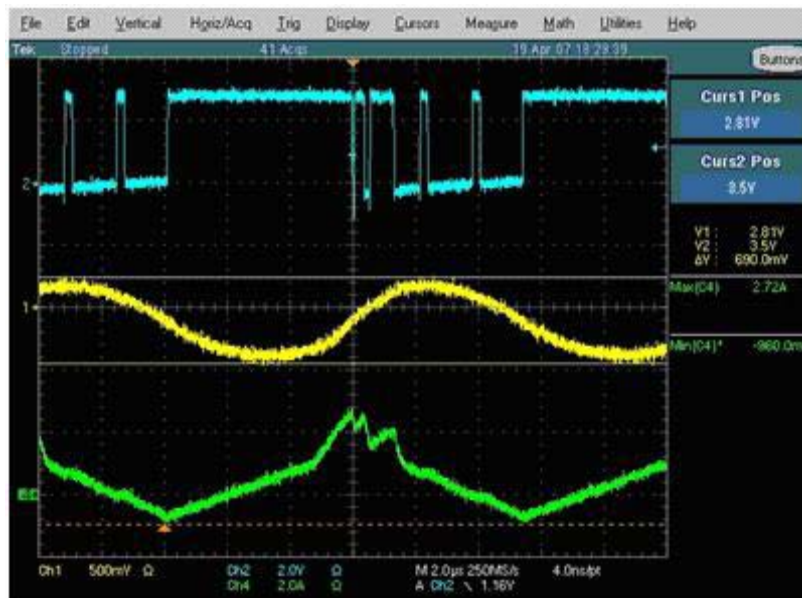

Figure 14. Ceramic 22 μ F 0805 (Y5V) (Bad)

A ceramic 22 μ F (X5R) will have a lower voltage ripple compared to the electrolytic 100 μ F. The key to choosing a proper output capacitor is to choose the lowest ESR to reduce the output voltage ripple. Choosing a ceramic 22 μ F 0805 (Y5V) in this case will cause malfunction of the switching regulator. Placing several Electrolytic capacitors in parallel will help lower the output voltage ripple.



Figure 15. Electrolytic 100 μ F (Ripple Too High)

The following figures show how different inductors affect the PIN 1 output waveform. The typical waveform should look like Figure 16, which has a square waveform with a dip at the falling edge and the rising edge. If the inductor is not carefully chosen, the waveform may look like Figure 17, where the waveform looks like a distorted square. This will cause insufficient current supply and will undermine the stability of the system at gigabit speed. Data in the following figures was measured at gigabit speed.

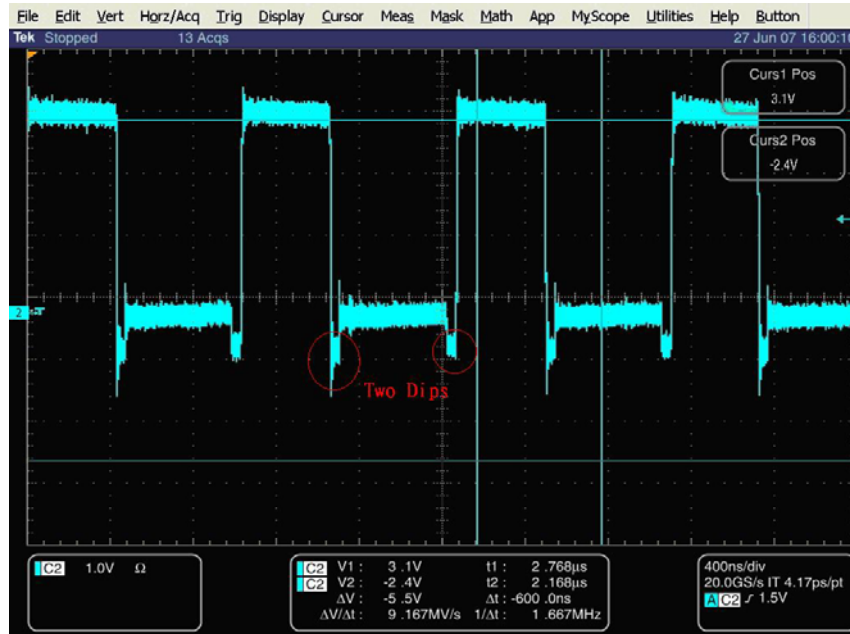

Figure 16. 4R7GTSD32 (Good)

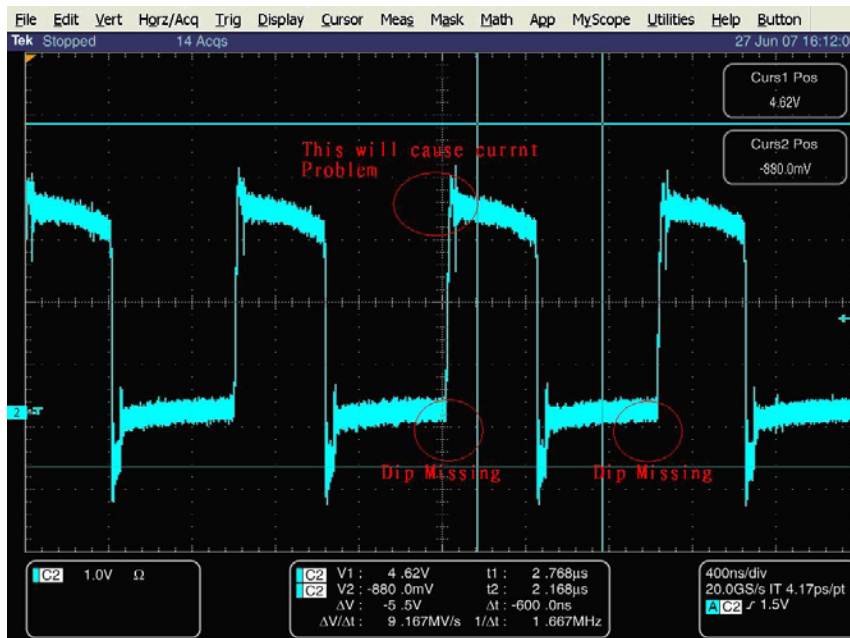

Figure 17. 1 μ H Bead (Bad)

7.4. Typical Switching Regulator PCB Layout

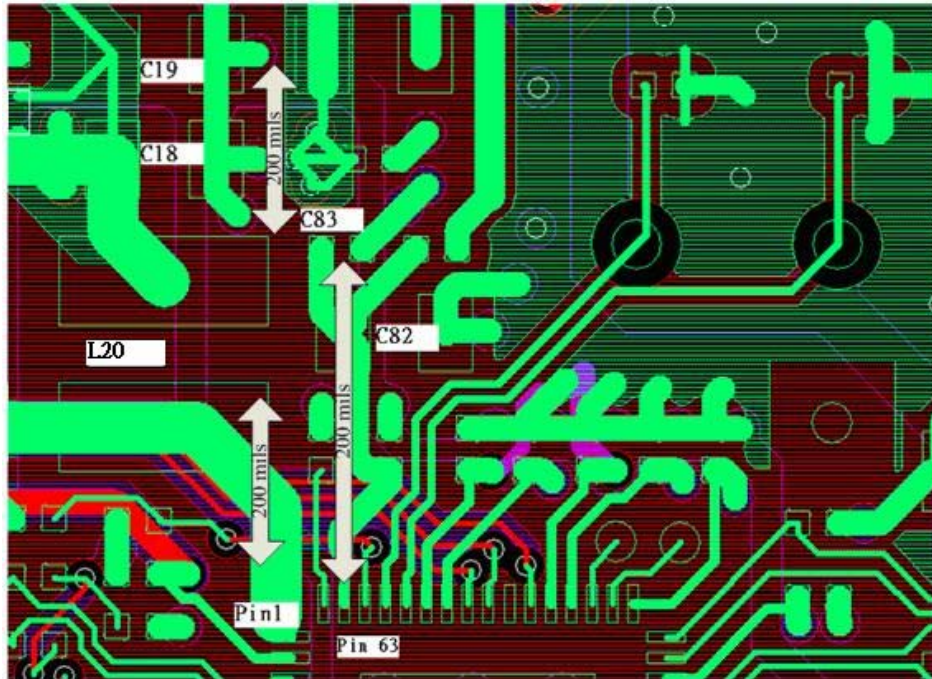

Figure 18. Typical Switching Regulator PCB Layout

7.5. Power Sequence

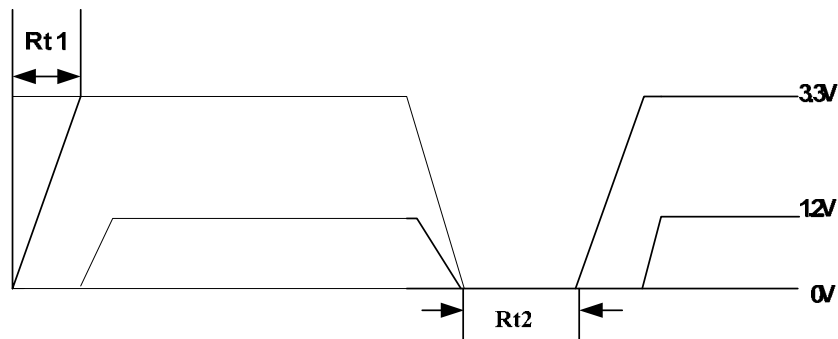

Figure 19. Power Sequence

Table 25. Power Sequence Parameter

| Symbol | Description | Min | Typical | Max | Units |
|--------|----------------|-----|---------|-----|-------|
| Rt1 | 3.3V Rise Time | 1 | - | 100 | ms |
| Rt2 | 3.3V Fall Time | 200 | - | - | ms |

Note1: The RTL8111C does not support fast 3.3V rising. The 3.3V rise time must be controlled over 1ms. If the rise time is too short it will induce a peak voltage in PIN63, which may cause permanent damage to the switching regulator.

Note 2: If there is any action which involves consecutive ON/OFF toggling of the switching-regulator source (3.3V), the design must make sure the OFF state of both the switching-regulator source (3.3V) and output (1.2V) reach 0V and the time period between the consecutive ON/OFF toggling action must be longer than 200ms.

8. Characteristics

8.1. Absolute Maximum Ratings

WARNING: Absolute maximum ratings are limits beyond which permanent damage may be caused to the device, or device reliability will be affected. All voltages are specified reference to GND unless otherwise specified.

Table 26. Absolute Maximum Ratings

| Symbol | Description | Minimum | Maximum | Unit |
|----------------|---------------------|---------|------------------------------------|------|
| VDD33, AVDD33 | Supply Voltage 3.3V | -0.3 | +0.30 | V |
| AVDD12, DVDD12 | Supply Voltage 1.2V | -0.3 | +0.12 | V |
| EVDD12 | Supply Voltage 1.2V | -0.3 | +0.12 | V |
| DCinput | Input Voltage | -0.3 | Corresponding Supply Voltage + 0.5 | V |
| DCoutput | Output Voltage | -0.3 | Corresponding Supply Voltage + 0.5 | V |
| N/A | Storage Temperature | -55 | +125 | °C |

Note: Refer to the most updated schematic circuit for correct configuration.

8.2. Recommended Operating Conditions

Table 27. Recommended Operating Conditions

| Description | Pins | Minimum | Typical | Maximum | Unit |
|-------------------------------------|----------------|---------|---------|---------|------|
| Supply Voltage VDD | VDD33, AVDD33 | 2.97 | 3.3 | 3.63 | V |
| | AVDD12, DVDD12 | 1.1 | 1.2 | 1.32 | V |
| | EVDD12 | 1.14 | 1.2 | 1.26 | V |
| Ambient Operating Temperature T_A | - | 0 | - | 70 | °C |
| Maximum Junction Temperature | - | - | - | 125 | °C |

Note: Refer to the most updated schematic circuit for correct configuration.

8.3. Crystal Requirements

Table 28. Crystal Requirements

| Symbol | Description/Condition | Minimum | Typical | Maximum | Unit |
|----------------------|-------------------------------------------------------------------------------------------------------------------------------------|---------|---------|---------|----------|
| F_{ref} | Parallel resonant crystal reference frequency, fundamental mode, AT-cut type. | - | 25 | - | MHz |
| F_{ref} Stability | Parallel resonant crystal frequency stability, fundamental mode, AT-cut type. $T_a = 25^\circ\text{C}$. | -50 | - | +50 | ppm |
| F_{ref} Tolerance | Parallel resonant crystal frequency tolerance, fundamental mode, AT-cut type. $T_a = -20^\circ\text{C} \sim +70^\circ\text{C}$. | -30 | - | +30 | ppm |
| F_{ref} Duty Cycle | Reference Clock Input Duty Cycle. | 40 | - | 60 | % |
| ESR | Equivalent Series Resistance. | - | - | 30 | Ω |
| DL | Drive Level. | - | - | 0.5 | mW |

8.4. Oscillator Requirements

Table 29. Oscillator Requirements

| Parameter | Condition | Minimum | Typical | Maximum | Unit |
|----------------------|------------------------------|---------|---------|---------|------|
| Frequency | - | - | 25 | - | MHz |
| Frequency Stability | T _a = 25°C | -30 | - | +30 | ppm |
| Frequency Tolerance | T _a = 0°C ~ +70°C | -50 | - | +50 | ppm |
| Duty Cycle | - | 40 | - | 60 | % |
| Jitter | - | - | - | 50 | ps |
| V _{p-p} | - | 3.15 | 3.3 | 3.45 | V |
| Rise Time | - | - | - | 10 | ns |
| Fall Time | - | - | - | 10 | ns |
| Operation Temp Range | - | 0 | - | 70 | °C |

8.5. Thermal Characteristics

Table 30. Thermal Characteristics

| Parameter | Minimum | Maximum | Units |
|-------------------------------|---------|---------|-------|
| Storage Temperature | -55 | +125 | °C |
| Ambient Operating Temperature | 0 | 70 | °C |

8.6. DC Characteristics

Table 31. DC Characteristics

| Symbol | Parameter | Conditions | Minimum | Typical | Maximum | Units |
|-------------------|--------------------------------------------|-------------------------------------|-----------|---------|-----------|-------|
| VDD33, AVDD33 | 3.3V Supply Voltage | - | 2.97 | 3.3 | 3.63 | V |
| DVDD12, AVDD12 | 1.2V Supply Voltage | - | 1.1 | 1.2 | 1.32 | V |
| EVDD12 | 1.2V Supply Voltage | - | 1.14 | 1.2 | 1.26 | V |
| V _{oh} | Minimum High Level Output Voltage | I _{oh} = -4mA | 0.9*VDD33 | - | VDD33 | V |
| V _{ol} | Maximum Low Level Output Voltage | I _{ol} = 4mA | 0 | - | 0.1*VDD33 | V |
| V _{ih} | Minimum High Level Input Voltage | - | 1.8 | - | - | V |
| V _{il} | Maximum Low Level Input Voltage | - | - | - | 0.8 | V |
| I _{in} | Input Current | V _{in} = VDD33 or GND | 0 | - | 0.5 | μA |
| I _{cc33} | Average Operating Supply Current from 3.3V | At 1Gbps with heavy network traffic | - | 68 | - | mA |
| I _{cc12} | Average Operating Supply Current from 1.2V | At 1Gbps with heavy network traffic | - | 340 | - | mA |

Note: Refer to the most updated schematic circuit for correct configuration.

8.7. AC Characteristics

8.7.1. Serial EEPROM Interface Timing

93C46(64*16)/93C56(128*16)

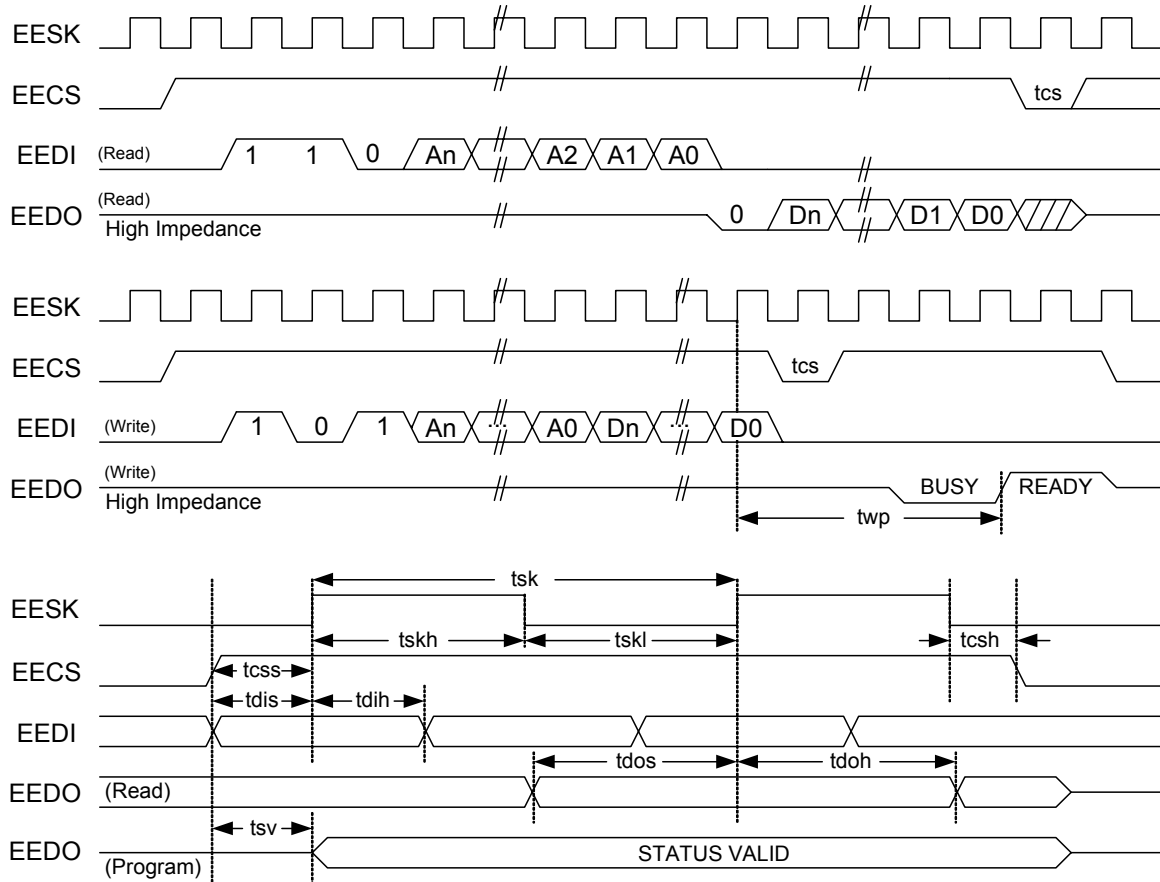

Figure 20. Serial EEPROM Interface Timing

Table 32. EEPROM Access Timing Parameters

| Symbol | Parameter | EEPROM Type | Min. | Max. | Unit |
|--------|---------------------|-------------|------|------|------|
| tcs | Minimum CS Low Time | 9346 | 1000 | - | ns |
| twp | Write Cycle Time | 9346 | - | 10 | ms |
| tsk | SK Clock Cycle Time | 9346 | 4 | - | μs |
| tskh | SK High Time | 9346 | 1000 | - | ns |
| tskl | SK Low Time | 9346 | 1000 | - | ns |
| tcss | CS Setup Time | 9346 | 200 | - | ns |
| tcsh | CS Hold Time | 9346 | 0 | - | ns |
| tdis | DI Setup Time | 9346 | 400 | - | ns |
| tdih | DI Hold Time | 9346 | 400 | - | ns |
| tdos | DO Setup Time | 9346 | 2000 | - | ns |
| tdoh | DO Hold Time | 9346 | - | 2000 | ns |
| tsv | CS to Status Valid | 9346 | - | 1000 | ns |

8.8. PCI Express Bus Parameters

8.8.1. Differential Transmitter Parameters

Table 33. Differential Transmitter Parameters

| Symbol | Parameter | Min | Typical | Max | Units |
|---------------------------------------------|----------------------------------------------------------------------------------------------------|--------|---------|------------|----------|
| UI | Unit Interval | 399.88 | 400 | 400.12 | ps |
| $V_{TX-DIFFp-p}$ | Differential Peak to Peak Output Voltage | 0.800 | - | 1.2 | V |
| $V_{TX-DE-RATIO}$ | De-Emphasized Differential Output Voltage (Ratio) | -3.0 | -3.5 | -4.0 | dB |
| T_{TX-EYE} | Minimum Tx Eye Width | 0.75 | - | - | UI |
| $T_{TX-EYE-MEDIAN-}$ $t_{to-MAX-JITTER}$ | Maximum Time between The Jitter Median and Maximum Deviation from The Median | - | - | 0.125 | UI |
| $T_{TX-RISE}, T_{TX-FALL}$ | D+/D- Tx Output Rise/Fall Time | 0.125 | - | - | UI |
| $V_{TX-CM-ACp}$ | RMS AC Peak Common Mode Output Voltage | - | - | 20 | mV |
| $V_{TX-CM-DCACTIVE-}$ $IDLEDELTA$ | Absolute Delta of DC Common Mode Voltage During L0 and Electrical Idle | 0 | - | 100 | mV |
| $V_{TX-CM-DCLINE-}$ $DELTA$ | Absolute Delta of DC Common Mode Voltage between D+ and D- | 0 | - | 25 | mV |
| $V_{TX-IDLE-DIFFp}$ | Electrical Idle Differential Peak Output Voltage | 0 | - | 20 | mV |
| $V_{TX-RCV-DETECT}$ | The Amount of Voltage Change Allowed During Receiver Detection | - | - | 600 | mV |
| $V_{TX-DC-CM}$ | The Tx DC Common Mode Voltage | 0 | - | 3.6 | V |
| $I_{TX-SHORT}$ | Tx Short Circuit Current Limit | - | - | 90 | mA |
| $T_{TX-IDLE-MIN}$ | Minimum Time Spent in Electrical Idle | 50 | - | - | UI |
| $T_{TX-IDLE-SETTO-IDLE}$ | Maximum Time to Transition to A Valid Electrical Idle After Sending An Electrical Idle Ordered Set | - | - | 20 | UI |
| $T_{TX-IDLE-TOTO-}$ $DIFF-DATA$ | Maximum Time to Transition to Valid Tx Specifications After Leaving An Electrical Idle Condition | - | - | 20 | UI |
| $RL_{TX-DIFF}$ | Differential Return Loss | 10 | - | - | dB |
| RL_{TX-CM} | Common Mode Return Loss | 6 | - | - | dB |
| $Z_{TX-DIFF-DC}$ | DC Differential Tx Impedance | 80 | 100 | 120 | Ω |
| $L_{TX-SKEW}$ | Lane-to-Lane Output Skew | - | - | $500+2*UI$ | ps |
| C_{TX} | AC Coupling Capacitor | 75 | - | 200 | nF |
| $T_{crosslink}$ | Crosslink Random Timeout | 0 | - | 1 | ms |

Note1: Refer to PCI Express Base Specification, rev.1.1, for correct measurement environment setting of each parameter.

Note2: The data rate can be modulated with an SSC (Spread Spectrum Clock) from +0 to -0.5% of the nominal data rate frequency, at a modulation rate in the range not exceeding 30kHz – 33kHz. The $\pm 300ppm$ requirement still holds, which requires the two communicating ports be modulated such that they never exceed a total of 600ppm difference.

8.8.2. Differential Receiver Parameters

Table 34. Differential Receiver Parameters

| Symbol | Parameter | Min. | Typical | Max. | Units |
|-----------------------------------|------------------------------------------------------------------------------|--------|---------|--------|----------|
| UI | Unit Interval | 399.88 | 400 | 400.12 | ps |
| $V_{RX-DIFFp-p}$ | Differential Input Peak to Peak Voltage | 0.175 | - | 1.200 | V |
| T_{RX-EYE} | Minimum Receiver Eye Width | 0.4 | - | - | UI |
| $T_{RX-EYE-MEDIAN-to-MAX-JITTER}$ | Maximum Time Between The Jitter Median and Maximum Deviation from The Median | - | - | 0.3 | UI |
| $V_{RX-CM-ACp}$ | AC Peak Common Mode Input Voltage | - | - | 150 | mV |
| $RL_{RX-DIFF}$ | Differential Return Loss | 10 | - | - | dB |
| RL_{RX-CM} | Common Mode Return Loss | 6 | - | - | dB |
| $Z_{RX-DIFF-DC}$ | DC Differential Input Impedance | 80 | 100 | 120 | Ω |
| Z_{RX-DC} | DC Input Impedance | 40 | 50 | 60 | Ω |
| $Z_{RX-HIGH-IMP-DC}$ | Powered Down DC Input Impedance | 200k | - | - | Ω |
| $V_{RX-IDLE-DET-DIFFp-p}$ | Electrical Idle Detect Threshold | 65 | - | 175 | mV |
| $T_{RX-IDLE-DET-DIFFERTIME}$ | Unexpected Electrical Idle Enter Detect Threshold Integration Time | - | - | 10 | ms |
| $L_{RX-SKEW}$ | Total Skew | - | - | 20 | ns |

Note: Refer to PCI Express Base Specification, rev.1.1, for correct measurement environment setting of each parameter.

8.8.3. REFCLK Parameters

Table 35. REFCLK Parameters

| Symbol | Parameter | 100MHz Input | | Units | Note |
|-------------------|-----------------------------------------------------------|--------------|--------|-------|-----------|
| | | Min | Max | | |
| Rise Edge Rate | Rising Edge Rate | 0.6 | 4.0 | V/ns | 2, 3 |
| Fall Edge Rate | Falling Edge Rate | 0.6 | 4.0 | V/ns | 2, 3 |
| V_{IH} | Differential Input High Voltage | +150 | - | mV | 2 |
| V_{IL} | Differential Input Low Voltage | - | -150 | mV | 2 |
| V_{CROSS} | Absolute Crossing Point Voltage | +250 | +550 | mV | 1, 4, 5 |
| $V_{CROSS DELTA}$ | Variation of V_{CROSS} Over All Rising Clock Edges | - | +140 | mV | 1, 4, 9 |
| V_{RB} | Ring-Back Voltage Margin | -100 | +100 | mV | 2, 12 |
| T_{STABLE} | Time before V_{RB} is Allowed | 500 | - | ps | 2, 12 |
| $T_{PERIOD AVG}$ | Average Clock Period Accuracy | -300 | +2800 | ppm | 2, 10, 13 |
| $T_{PERIOD ABS}$ | Absolute Period (Including Jitter and Spread Spectrum) | 9.847 | 10.203 | ns | 2, 6 |
| $T_{CCJITTER}$ | Cycle to Cycle Jitter | - | 150 | ps | 2 |
| V_{MAX} | Absolute Maximum Input Voltage | - | +1.15 | V | 1, 7 |
| V_{MIN} | Absolute Minimum Input Voltage | - | -0.3 | V | 1, 8 |

| Symbol | Parameter | 100MHz Input | | Units | Note |
|--------------------|-----------------------------------------------------------------------|--------------|-----|-------|-------|
| | | Min | Max | | |
| Duty Cycle | Duty Cycle | 40 | 60 | % | 2 |
| Rise-Fall Matching | Rising Edge Rate (REFCLK+) to Falling Edge Rate (REFCLK-) Matching | - | 20 | % | 1, 14 |
| Z _{C-DC} | Clock Source DC Impedance | 40 | 60 | Ω | 1, 11 |

Note1: Measurement taken from single-ended waveform.

Note2: Measurement taken from differential waveform.

Note3: Measured from -150mV to +150mV on the differential waveform (derived from REFCLK+ minus REFCLK-). The signal must be monotonic through the measurement region for rise and fall time. The 300mV measurement window is centered on the differential zero crossing. See Figure 24, page 38.

Note4: Measured at crossing point where the instantaneous voltage value of the rising edge of REFCLK+ equals the falling edge of REFCLK-. See Figure 20, page 33.

Note5: Refers to the total variation from the lowest crossing point to the highest, regardless of which edge is crossing. Refers to all crossing points for this measurement. See Figure 20, page 33.

Note6: Defines as the absolute minimum or maximum instantaneous period. This includes cycle to cycle jitter, relative ppm tolerance, and spread spectrum modulation. See Figure 23, page 37.

Note7: Defined as the maximum instantaneous voltage including overshoot. See Figure 20, page 33.

Note8: Defined as the minimum instantaneous voltage including undershoot. See Figure 20, page 33.

Note9: Defined as the total variation of all crossing voltages of Rising REFCLK+ and Falling REFCLK-. This is the maximum allowed variance in VCROSS for any particular system. See Figure 21, page 37.

Note10: Refer to Section 4.3.2.1 of the PCI Express Base Specification, Revision 1.1 for information regarding ppm considerations.

Note11: System board compliance measurements must use the test load card described in Figure 27, page 39. REFCLK+ and REFCLK- are to be measured at the load capacitors CL. Single ended probes must be used for measurements requiring single ended measurements. Either single ended probes with math or differential probe can be used for differential measurements. Test load CL=2pF.

Note12: TSTABLE is the time the differential clock must maintain a minimum ±150mV differential voltage after rising/falling edges before it is allowed to droop back into the VRB ±100mV differential range. See Figure 26, page 38.

Note13: ppm refers to parts per million and is a DC absolute period accuracy specification. 1ppm is 1/1,000,000th of 100.000000MHz exactly, or 100Hz. For 300ppm then we have an error budget of 100Hz/ppm*300ppm=30kHz. The period is to be measured with a frequency counter with measurement window set to 100ms or greater. The ±300ppm applies to systems that do not employ Spread Spectrum or that use common clock source. For systems employing Spread Spectrum there is an additional 2500ppm nominal shift in maximum period resulting from the 0.5% down spread resulting in a maximum average period specification of +2800ppm

Note14: Matching applies to rising edge rate for REFCLK+ and falling edge rate for REFCLK-. It is measured using a ±75mV window centered on the median cross point where REFCLK+ rising meets REFCLK- falling. The median cross point is used to calculate the voltage thresholds the oscilloscope is to use for the edge rate calculations. The Rise Edge Rate of REFCLK+ should be compared to the Fall Edge Rate of REFCLK-, the maximum allowed difference should not exceed 20% of the slowest edge rate. See Figure 22, page 37.

Note15: Refer to PCI Express Card Electromechanical Specification, rev.1.1, for correct measurement environment setting of each parameter.

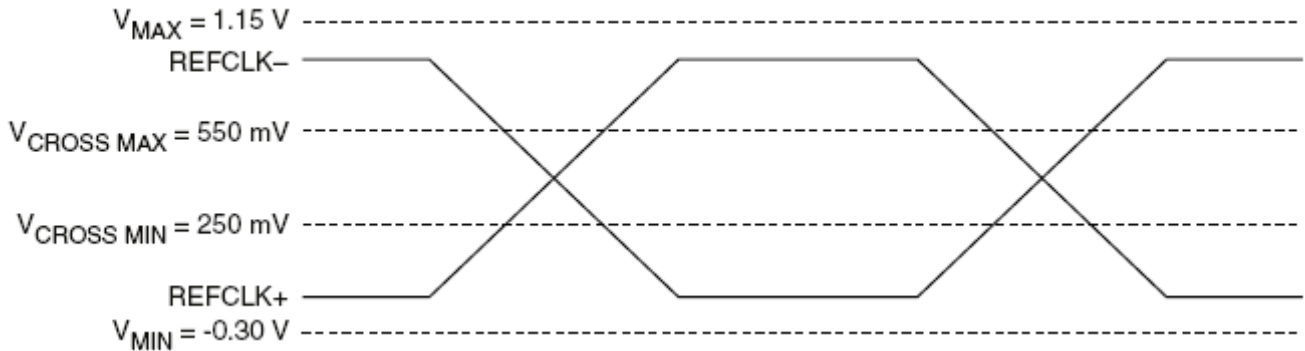

Figure 21. Single-Ended Measurement Points for Absolute Cross Point and Swing

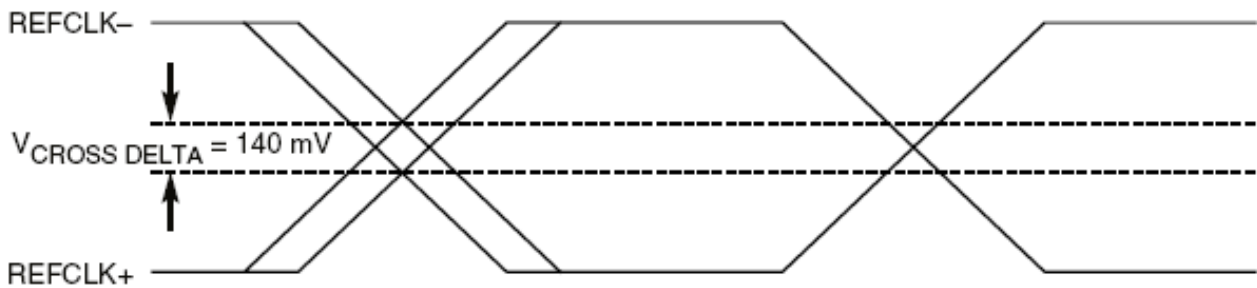

Figure 22. Single-Ended Measurement Points for Delta Cross Point

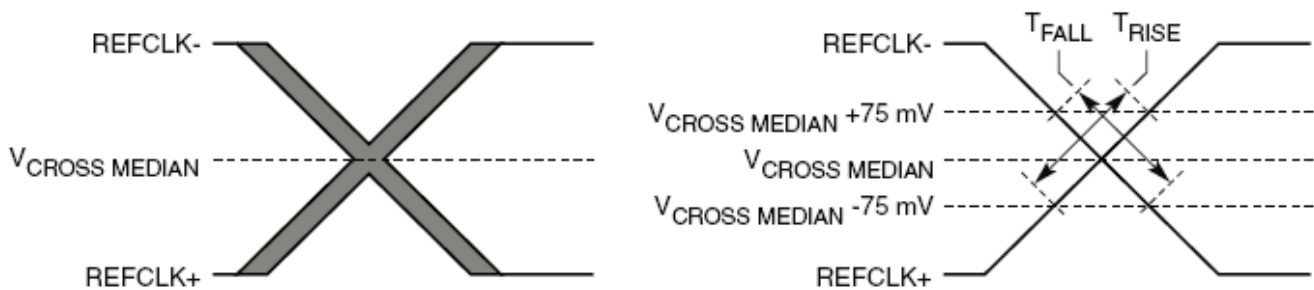

Figure 23. Single-Ended Measurement Points for Rise and Fall Time Matching

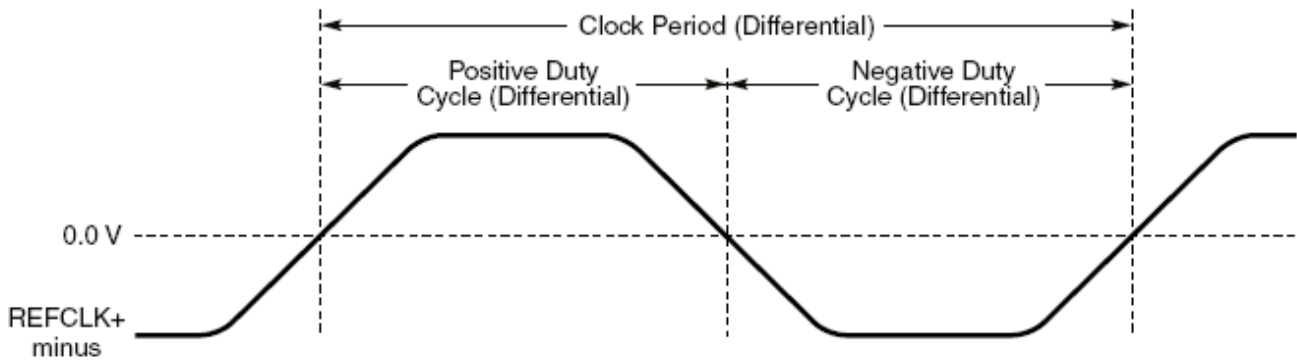

Figure 24. Differential Measurement Points for Duty Cycle and Period

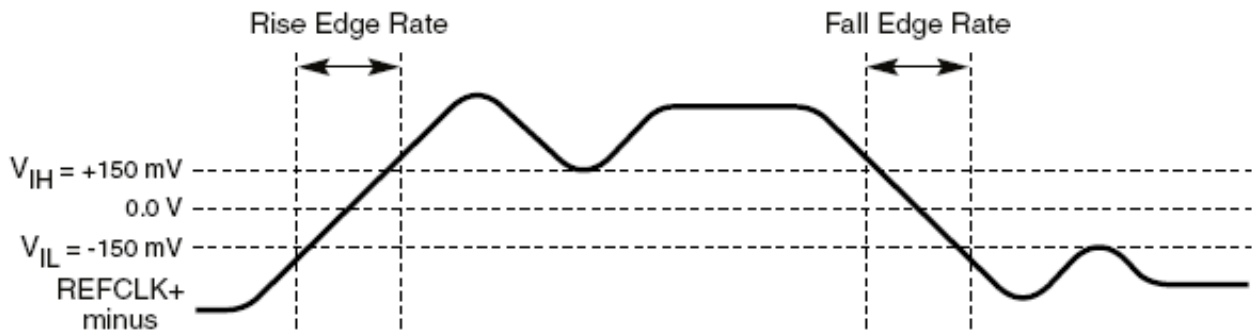

Figure 25. Differential Measurement Points for Rise and Fall Time

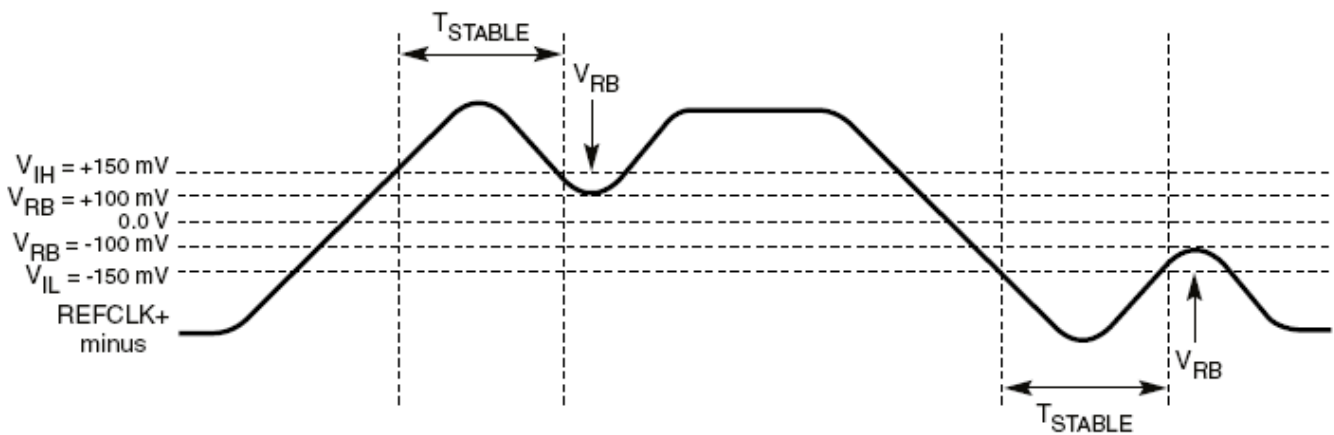

Figure 26. Differential Measurement Points for Ringback

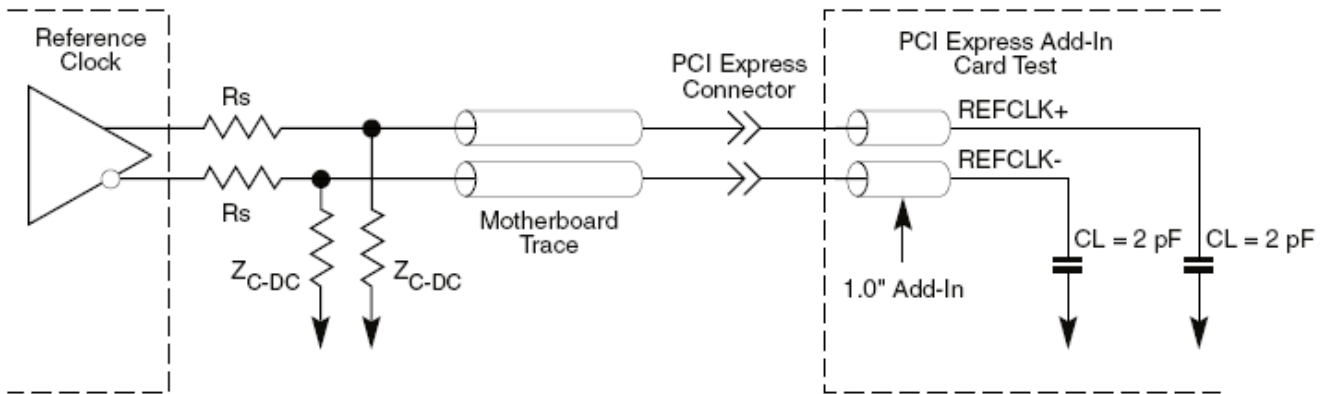

Figure 27. Reference Clock System Measurement Point and Loading

8.8.4. Auxiliary Signal Timing Parameters

Table 36. Auxiliary Signal Timing Parameters

| Symbol | Parameter | Min | Max | Units |
|-----------------|---------------------------------------|-----|-----|---------|
| T_{PVPERL} | Power Stable to PERSTB Inactive | 100 | - | ms |
| $T_{PERST-CLK}$ | REFCLK Stable before PERSTB Inactive | 100 | - | μ s |
| T_{PERST} | PERSTB Active Time | 100 | - | μ s |
| T_{FAIL} | Power Level Invalid to PWRGD Inactive | - | 500 | ns |
| T_{WKRF} | LANWAKEB Rise – Fall Time | - | 100 | ns |

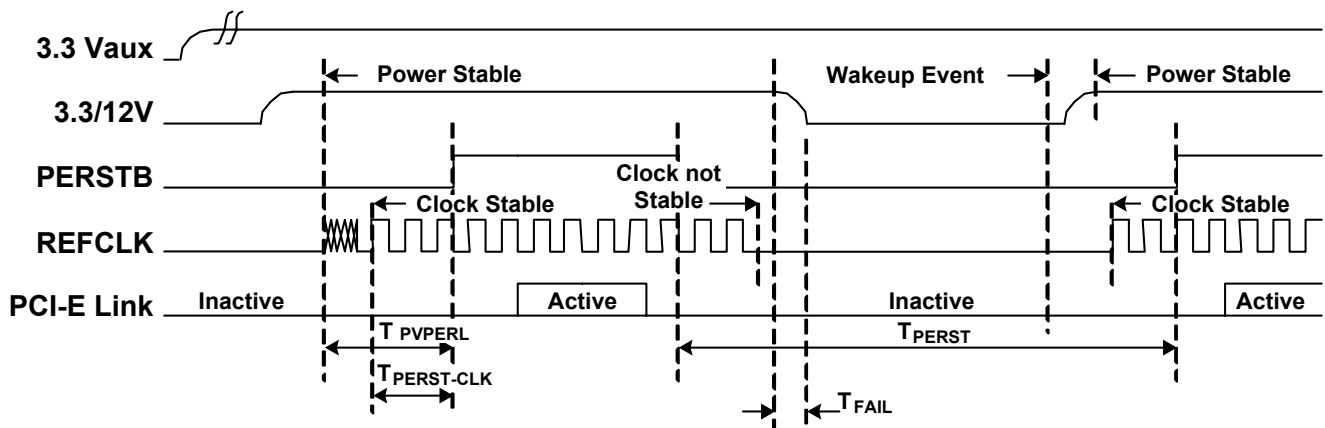
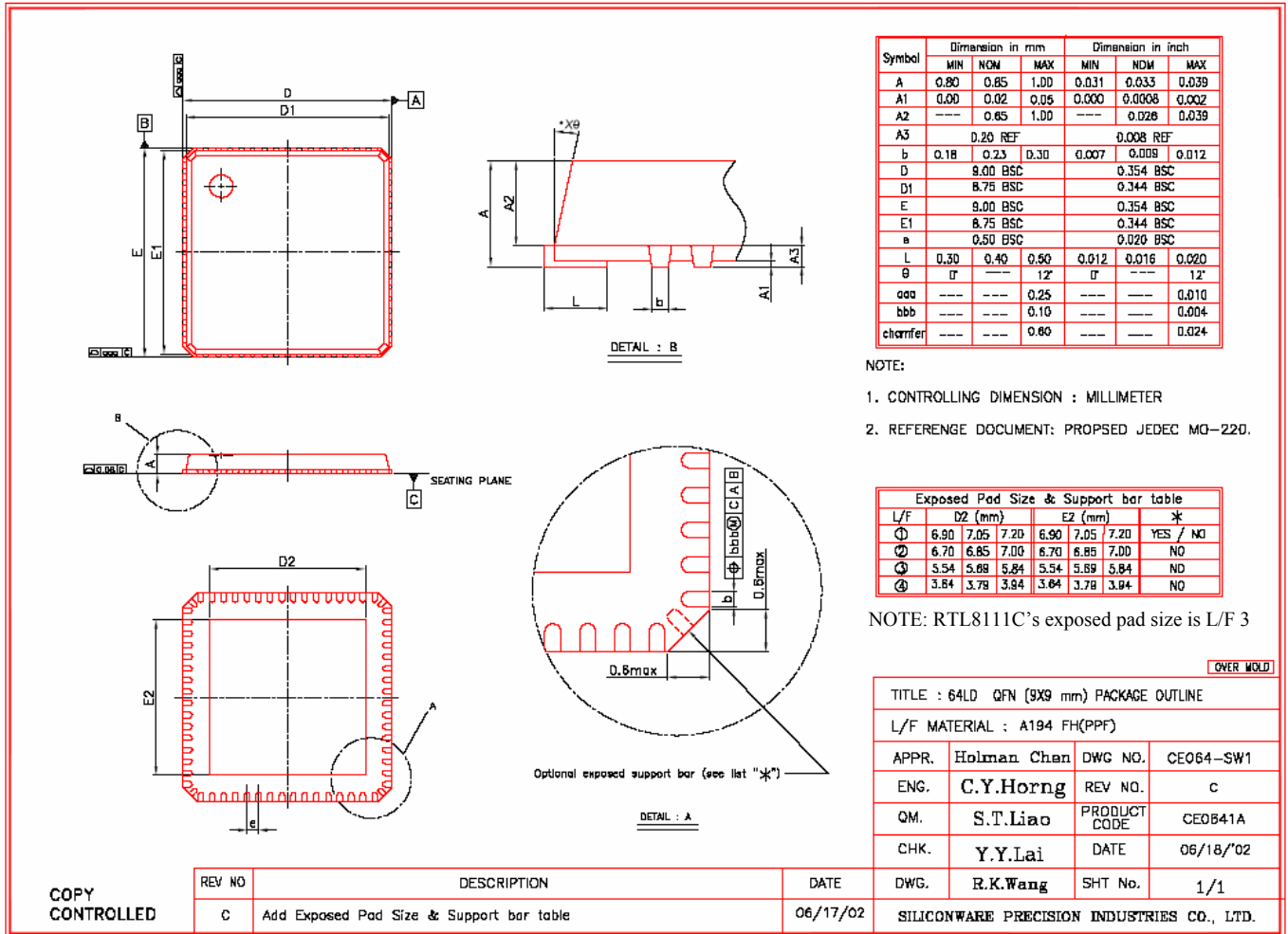

Figure 28. Auxiliary Signal Timing

9. Mechanical Dimensions



10. Ordering Information

Table 37. Ordering Information

| Part Number | Package | Status |
|----------------|-------------------------------|------------|
| RTL8111C-GR | 64-Pin QFN 'Green' Package | Production |
| RTL8111C-VB-GR | RTL8111C-GR Version B Silicon | Production |
| RTL8111C-VC-GR | RTL8111C-GR Version C Silicon | Production |

Note: See page 3 for package ID information.

Realtek Semiconductor Corp.**Headquarters**

No. 2, Innovation Road II

Hsinchu Science Park, Hsinchu 300, Taiwan

Tel.: +886-3-578-0211. Fax: +886-3-577-6047

www.realtek.com.tw