

Features

- 68V/88A,
 $R_{DS(ON)} = 6m\Omega(Typ.)@V_{GS}=10V$
- Insulation Slug($V_{ISO} \geq 1500VAC$)
- Ultra Low On-Resistance
- Exceptional dv/dt capability
- Fast Switching and Fully Avalanche Rated
- 100% avalanche tested
- 175°C Operating Temperature
- Lead Free and Green Devices Available (RoHS Compliant)

Applications

- Switching Application Systems
- Inverter Systems

Pin Description

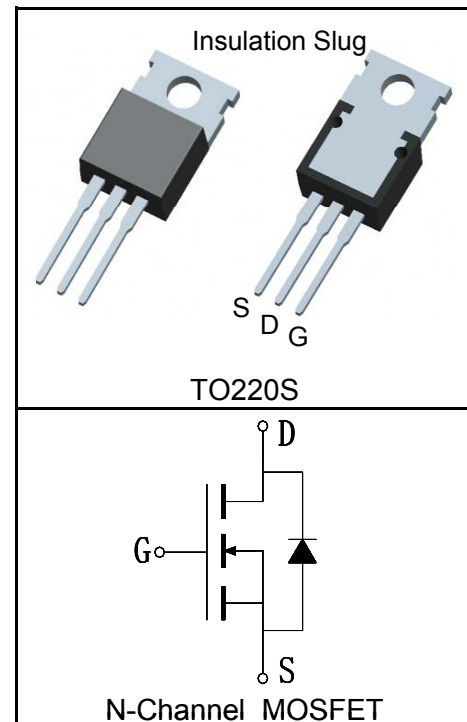

Absolute Maximum Ratings

Symbol	Parameter	Rating	Unit	
Common Ratings ($T_C=25^\circ C$ Unless Otherwise Noted)				
V_{DSS}	Drain-Source Voltage	68	V	
V_{GSS}	Gate-Source Voltage	± 25		
T_J	Maximum Junction Temperature	175	$^\circ C$	
T_{STG}	Storage Temperature Range	-55 to 175	$^\circ C$	
I_S	Diode Continuous Forward Current	$T_C=25^\circ C$	88	A
Mounted on Large Heat Sink				
$I_{DP}^{①}$	300 μs Pulse Drain Current Tested	$T_C=25^\circ C$	320	A
$I_D^{②}$	Continuous Drain Current($V_{GS}=10V$)	$T_C=25^\circ C$	88	A
		$T_C=100^\circ C$	65	
P_D	Maximum Power Dissipation	$T_C=25^\circ C$	120	W
		$T_C=100^\circ C$	60	
$R_{\theta JC}$	Thermal Resistance-Junction to Case	1.25	$^\circ C/W$	
$R_{\theta JA}$	Thermal Resistance-Junction to Ambient	62.5	$^\circ C/W$	
Drain-Source Avalanche Ratings				
$E_{AS}^{③}$	Avalanche Energy, Single Pulsed	225	mJ	

Electrical Characteristics ($T_C=25^\circ\text{C}$ Unless Otherwise Noted)

Symbol	Parameter	Test Condition	RU6888R3			Unit
			Min.	Typ.	Max.	
Static Characteristics						
BV_{DSS}	Drain-Source Breakdown Voltage	$V_{GS}=0V, I_{DS}=250\mu A$	68			V
I_{DSS}	Zero Gate Voltage Drain Current	$V_{DS}=68V, V_{GS}=0V$			1	μA
		$T_J=125^\circ C$			30	
$V_{GS(th)}$	Gate Threshold Voltage	$V_{DS}=V_{GS}, I_{DS}=250\mu A$	2	3	4	V
I_{GSS}	Gate Leakage Current	$V_{GS}=\pm 25V, V_{DS}=0V$			± 100	nA
$R_{DS(ON)}^{(4)}$	Drain-Source On-state Resistance	$V_{GS}=10V, I_{DS}=40A$		6	8	m Ω
Diode Characteristics						
$V_{SD}^{(4)}$	Diode Forward Voltage	$I_{SD}=40A, V_{GS}=0V$			1.2	V
t_{rr}	Reverse Recovery Time	$I_{SD}=40A, di_{SD}/dt=100A/\mu s$		49		ns
Q_{rr}	Reverse Recovery Charge			93		nC
Dynamic Characteristics ⁽⁵⁾						
R_G	Gate Resistance	$V_{GS}=0V, V_{DS}=0V, F=1MHz$		1.4		Ω
C_{iss}	Input Capacitance	$V_{GS}=0V,$ $V_{DS}=30V,$ Frequency=1.0MHz		2900		pF
C_{oss}	Output Capacitance			340		
C_{riss}	Reverse Transfer Capacitance			200		
$t_{d(ON)}$	Turn-on Delay Time	$V_{DD}=30V, I_{DS}=40A,$ $V_{GEN}=10V, R_G=8\Omega$		13		ns
t_r	Turn-on Rise Time			15		
$t_{d(OFF)}$	Turn-off Delay Time			29		
t_f	Turn-off Fall Time			55		
Gate Charge Characteristics ⁽⁵⁾						
Q_g	Total Gate Charge	$V_{DS}=54V, V_{GS}=10V,$ $I_{DS}=40A$		65		nC
Q_{gs}	Gate-Source Charge			12		
Q_{gd}	Gate-Drain Charge			21		

- Notes:
- ① Pulse width limited by safe operating area.
 - ② Calculated continuous current based on maximum allowable junction temperature. The package limitation current is 75A.
 - ③ Limited by T_{Jmax} , $I_{AS}=30A$, $V_{DD}=48V$, $R_G=50\Omega$, Starting $T_J=25^\circ C$.
 - ④ Pulse test; Pulse width $\leq 300\mu s$, duty cycle $\leq 2\%$.
 - ⑤ Guaranteed by design, not subject to production testing.

Ordering and Marking Information

Device	Marking	Package	Packaging	Quantity	Reel Size	Tape width
RU6888R3	RU6888R3	TO220S	Tube	50	-	-

Typical Characteristics

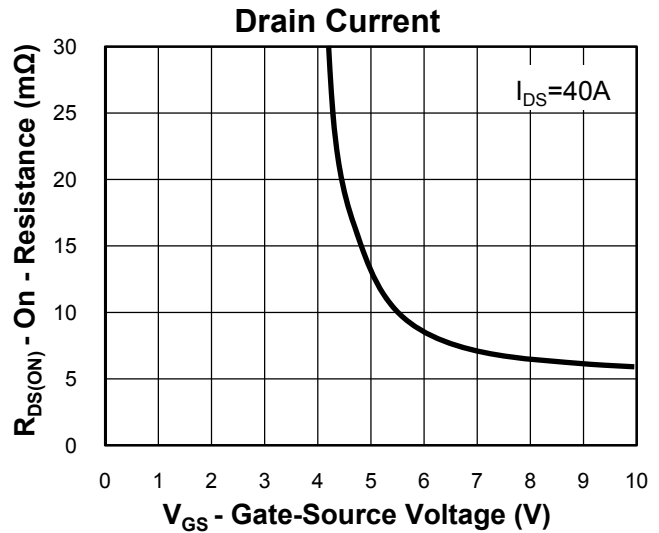
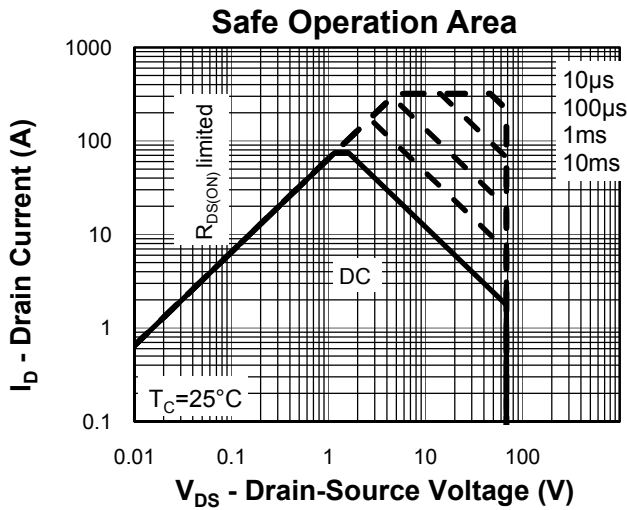
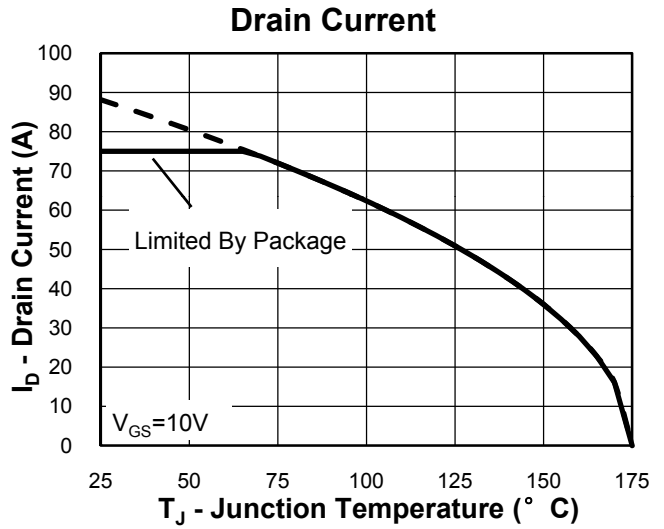
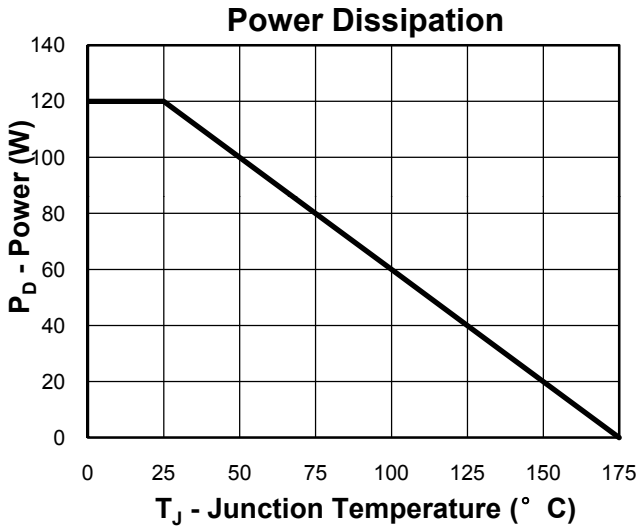

Thermal Transient Impedance

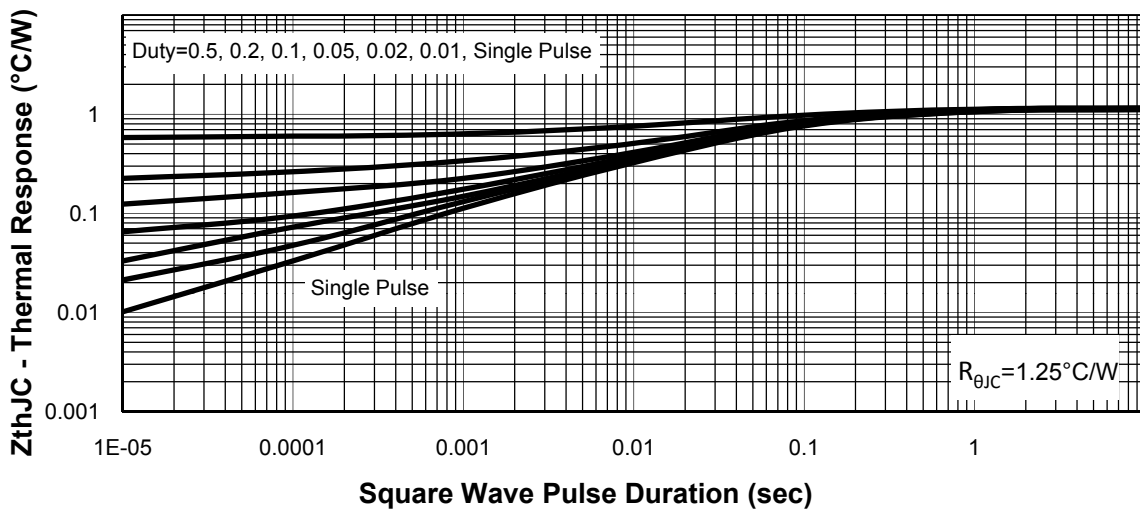

Typical Characteristics

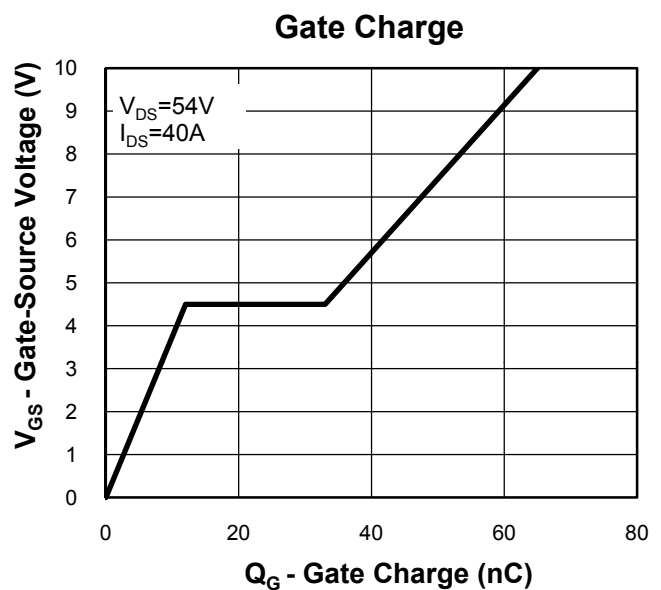
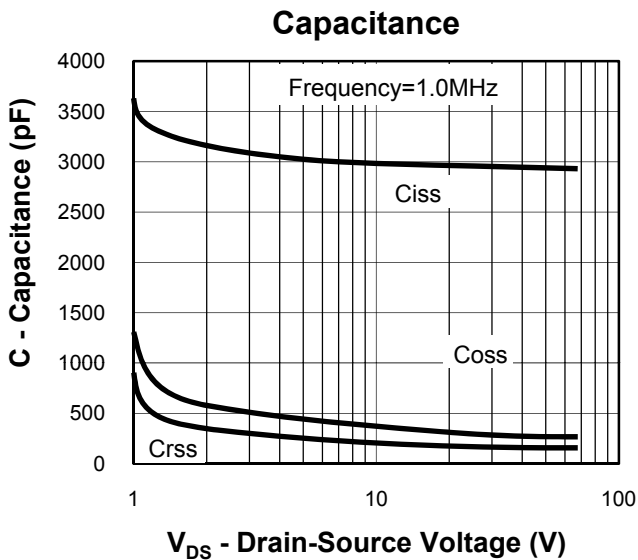
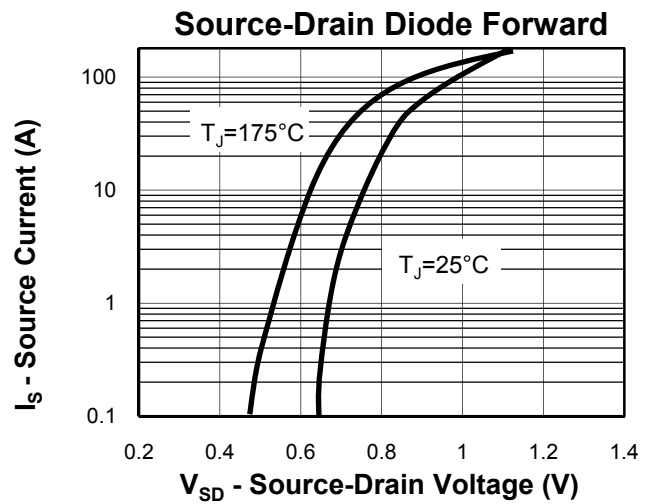
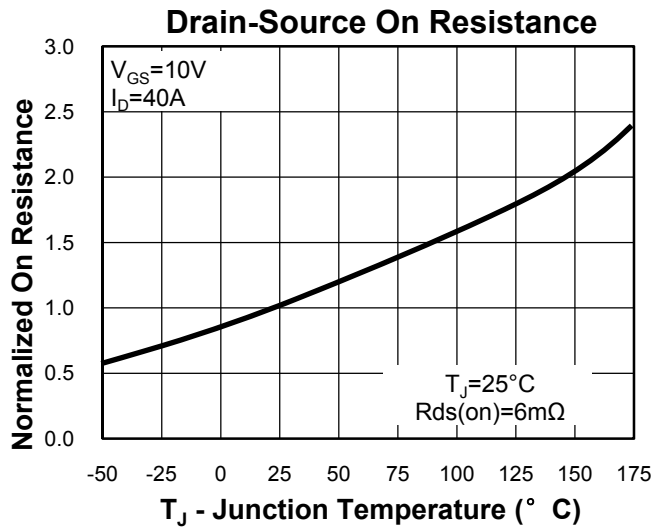
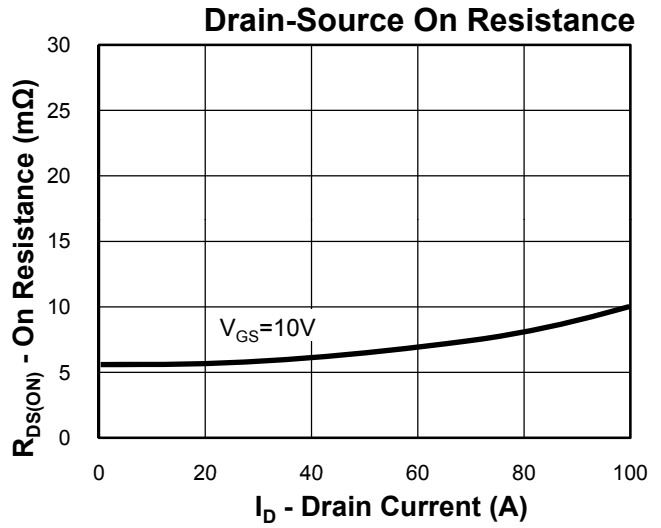
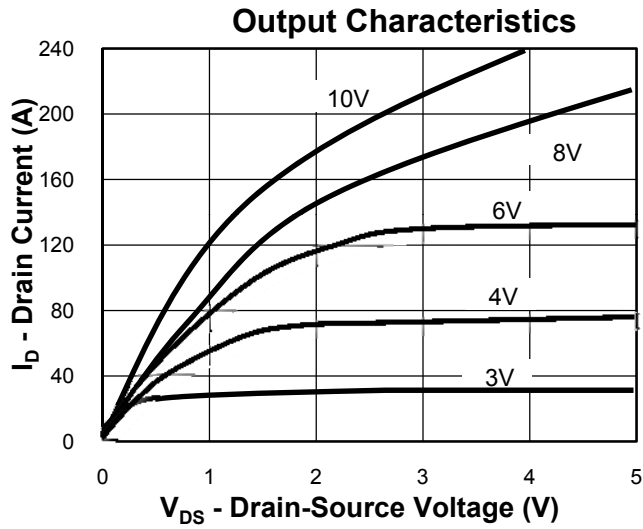

Avalanche Test Circuit and Waveforms

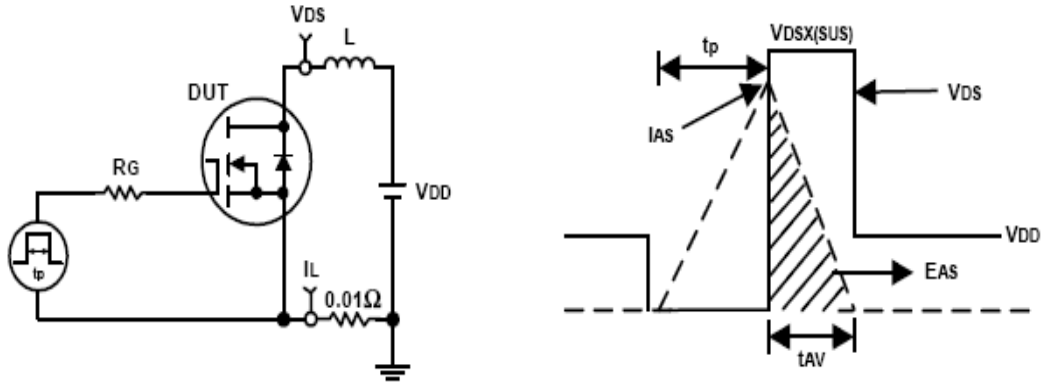

Switching Time Test Circuit and Waveforms

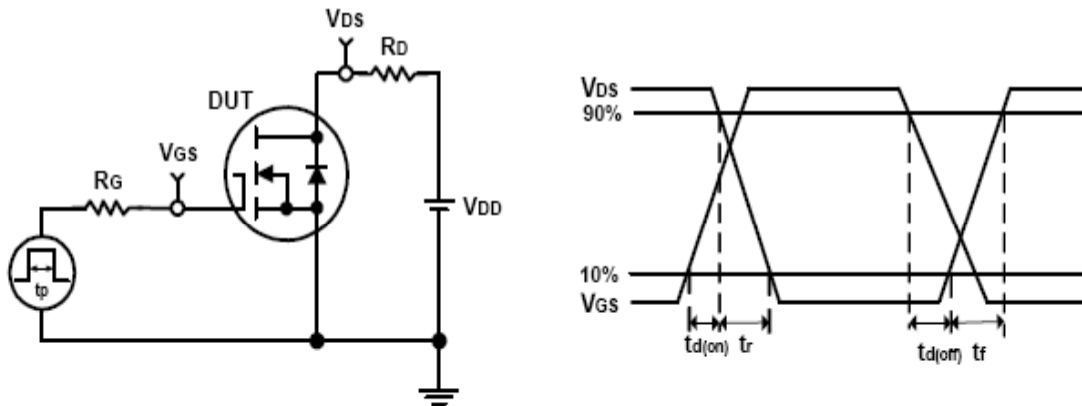

Package Information

TO220S

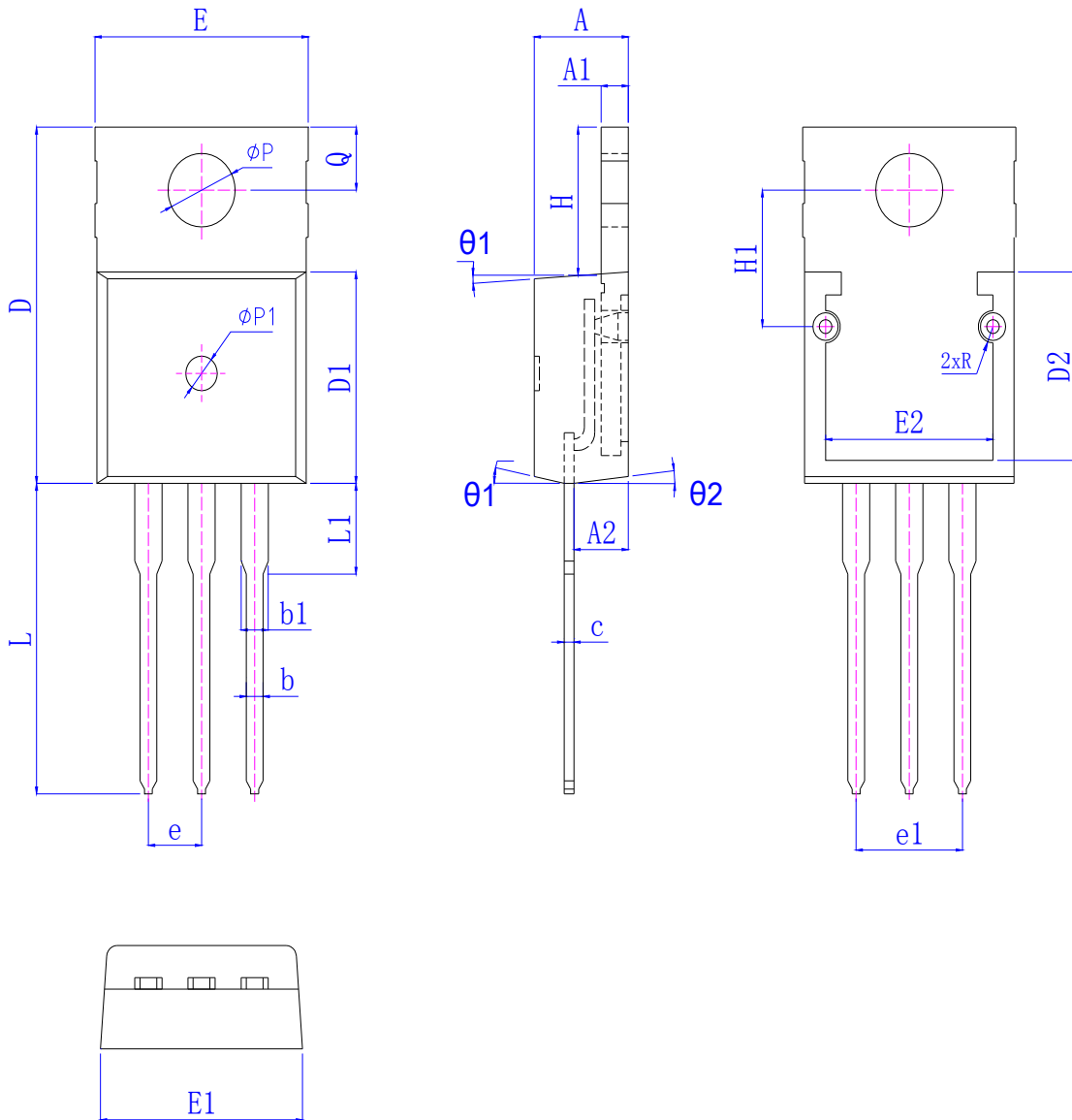

SYMBOL	MM			INCH			SYMBOL	MM			INCH		
	MIN	NOM	MAX	MIN	NOM	MAX		MIN	NOM	MAX	MIN	NOM	MAX
A	4.30	4.50	4.70	0.169	0.177	0.185	Φp	3.20	*	3.30	0.126	*	0.130
A1	1.25	1.27	1.29	0.049	0.050	0.051	e	2.54 BSC			0.10 BSC		
A2	2.37	2.57	2.77	0.093	0.101	0.109	e1	5.08 BSC			0.20 BSC		
b	0.60	0.80	1.00	0.024	0.031	0.039	H	6.13	6.23	6.43	0.241	0.245	0.253
b1	1.24	1.34	1.44	0.049	0.053	0.057	H1	5.89	5.94	5.99	0.232	0.234	0.236
c	0.40	0.50	0.60	0.016	0.020	0.024	L	12.90	13.40	13.90	0.508	0.528	0.547
D	15.33	15.53	15.73	0.604	0.611	0.619	L1	*	*	3.92	*	*	0.154
D1	9.10	9.30	9.50	0.358	0.366	0.374	$\Phi p1$	1.40	1.50	1.60	0.055	0.059	0.063
D2	8.14	8.19	8.24	0.320	0.322	0.324	Q	*	2.74	*	*	0.108	*
E	10.10	10.20	10.30	0.398	0.402	0.406	R	0.675	0.700	0.725	0.027	0.028	0.029
E1	9.96	10.16	10.36	0.392	0.400	0.408	$\theta 1$	1°	3°	5°	1°	3°	5°
E2	8.13	8.18	8.23	0.320	0.322	0.324	$\theta 2$	1°	3°	5°	1°	3°	5°

Customer Service

Worldwide Sales and Service:
Sales@ruichips.com

Technical Support:
Technical@ruichips.com

Investor Relations Contacts:
Investor@ruichips.com

Marcom Contact:
Marcom@ruichips.com

Editorial Contact:
Editorial@ruichips.com

HR Contact:
HR@ruichips.com

Legal Contact:
Legal@ruichips.com

Shen Zhen RUICHIPS Semiconductor CO., LTD
Room 501, the 5floor An Tong Industrial Building,
NO.207 Mei Hua Road Fu Tian Area Shen Zhen City, CHINA

TEL: (86-755) 8311-5334
FAX: (86-755) 8311-4278
E-mail: Sales-SZ@ruichips.com