

Features

- 70V/80A,
 $R_{DS(ON)} = 7m\Omega(Typ.)@V_{GS}=10V$
- Ultra Low On-Resistance
- Fast Switching
- 100% avalanche tested
- 175°C Operating Temperature
- Lead Free and Green Devices Available (RoHS Compliant)



Applications

- Motor Drives
- Uninterruptible Power Supplies
- DC/DC converter
- General Purpose Applications

Pin Description

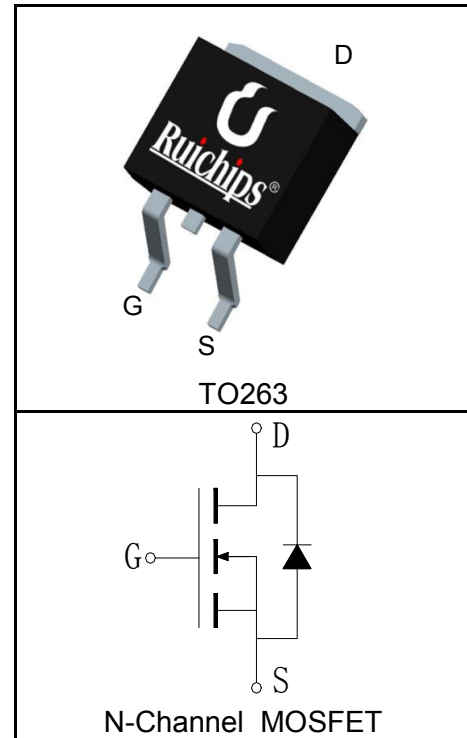

Absolute Maximum Ratings

Symbol	Parameter	Rating	Unit
Common Ratings ($T_C=25^\circ C$ Unless Otherwise Noted)			
V_{DSS}	Drain-Source Voltage	70	V
V_{GSS}	Gate-Source Voltage	± 25	
T_J	Maximum Junction Temperature	175	$^\circ C$
T_{STG}	Storage Temperature Range	-55 to 175	$^\circ C$
I_S	Diode Continuous Forward Current	$T_C=25^\circ C$ 75	A
Mounted on Large Heat Sink			
$I_{DP}^{①}$	300 μs Pulse Drain Current Tested	$T_C=25^\circ C$ 300	A
$I_D^{②}$	Continuous Drain Current($V_{GS}=10V$)	$T_C=25^\circ C$ 80	A
		$T_C=100^\circ C$ 56	
P_D	Maximum Power Dissipation	$T_C=25^\circ C$ 111	W
		$T_C=100^\circ C$ 55	
$R_{\theta JC}$	Thermal Resistance-Junction to Case	1.35	$^\circ C/W$
$R_{\theta JA}$	Thermal Resistance-Junction to Ambient	62.5	$^\circ C/W$
Drain-Source Avalanche Ratings			
$E_{AS}^{③}$	Avalanche Energy, Single Pulsed	156	mJ

Electrical Characteristics ($T_C=25^\circ\text{C}$ Unless Otherwise Noted)

Symbol	Parameter	Test Condition	RU7080S			Unit
			Min.	Typ.	Max.	
Static Characteristics						
BV_{DSS}	Drain-Source Breakdown Voltage	$V_{GS}=0V, I_{DS}=250\mu A$	70			V
I_{DSS}	Zero Gate Voltage Drain Current	$V_{DS}=70V, V_{GS}=0V$			1	μA
		$T_J=125^\circ\text{C}$			30	
$V_{GS(th)}$	Gate Threshold Voltage	$V_{DS}=V_{GS}, I_{DS}=250\mu A$	2		4	V
I_{GSS}	Gate Leakage Current	$V_{GS}=\pm 25V, V_{DS}=0V$			± 100	nA
$R_{DS(ON)}^{(4)}$	Drain-Source On-state Resistance	$V_{GS}=10V, I_{DS}=40A$		7	9	m Ω
Diode Characteristics						
$V_{SD}^{(4)}$	Diode Forward Voltage	$I_{SD}=75A, V_{GS}=0V$			1.2	V
t_{rr}	Reverse Recovery Time	$I_{SD}=75A, di_{SD}/dt=100A/\mu s$		106		ns
Q_{rr}	Reverse Recovery Charge			56		nC
Dynamic Characteristics ⁽⁵⁾						
R_G	Gate Resistance	$V_{GS}=0V, V_{DS}=0V, F=1\text{MHz}$		1.2		Ω
C_{iss}	Input Capacitance	$V_{GS}=0V,$ $V_{DS}=30V,$ Frequency=1.0MHz		1800		pF
C_{oss}	Output Capacitance			380		
C_{riss}	Reverse Transfer Capacitance			105		
$t_{d(ON)}$	Turn-on Delay Time	$V_{DD}=30V, I_{DS}=75A,$ $V_{GEN}=10V, R_G=4.7\Omega$		15		ns
t_r	Turn-on Rise Time			94		
$t_{d(OFF)}$	Turn-off Delay Time			46		
t_f	Turn-off Fall Time			32		
Gate Charge Characteristics ⁽⁵⁾						
Q_g	Total Gate Charge	$V_{DS}=56V, V_{GS}=10V,$ $I_{DS}=75A$		50		nC
Q_{gs}	Gate-Source Charge			12		
Q_{gd}	Gate-Drain Charge			19		

- Notes:
- ① Pulse width limited by safe operating area.
 - ② Calculated continuous current based on maximum allowable junction temperature. The package limitation current is 75A.
 - ③ Limited by T_{Jmax} , $I_{AS}=25A$, $V_{DD}=48V$, $R_G=50\Omega$, Starting $T_J=25^\circ\text{C}$.
 - ④ Pulse test; Pulse width $\leq 300\mu s$, duty cycle $\leq 2\%$.
 - ⑤ Guaranteed by design, not subject to production testing.

Typical Characteristics

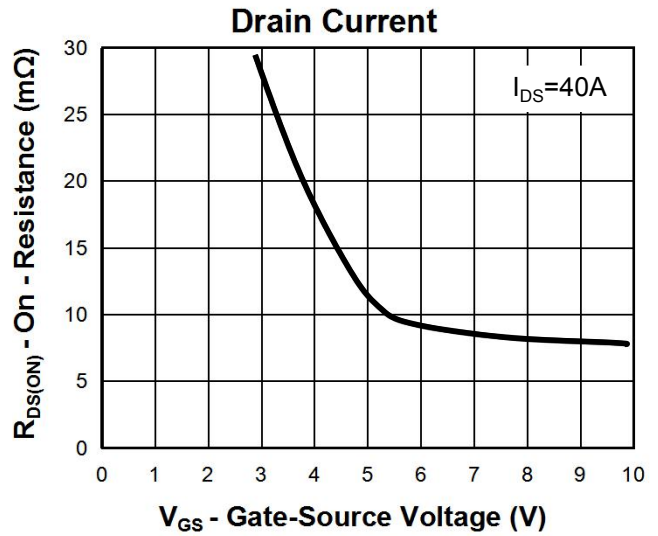
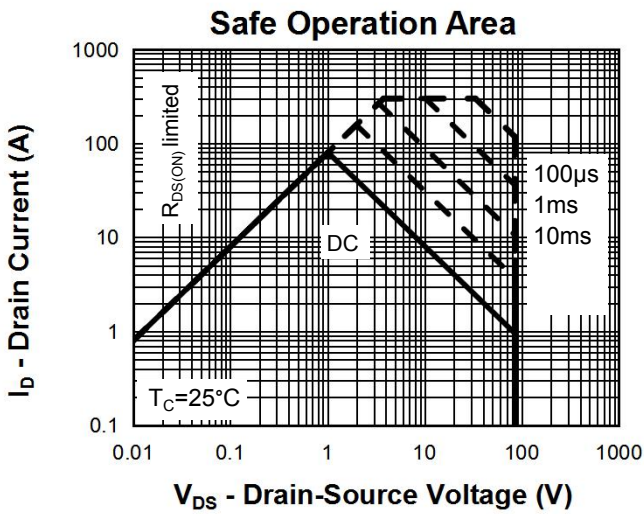
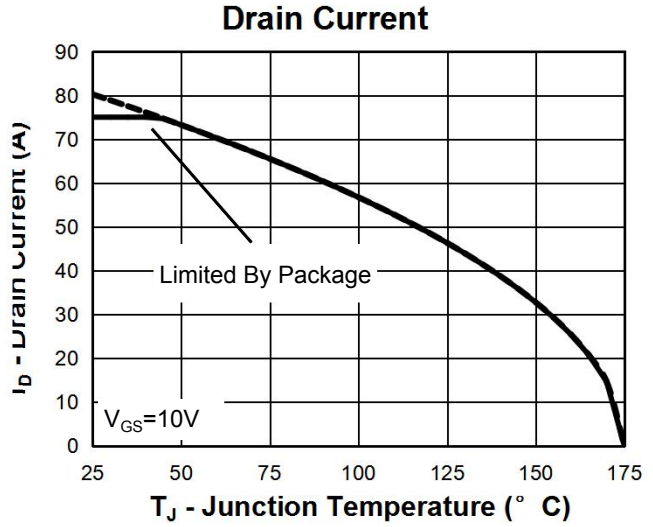
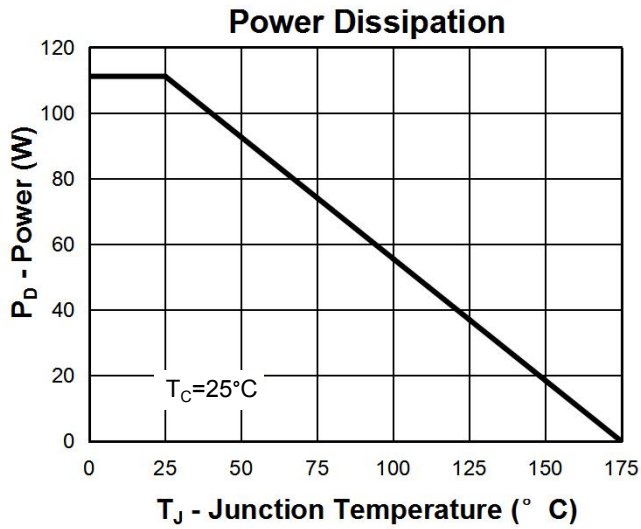

Transient Impedance

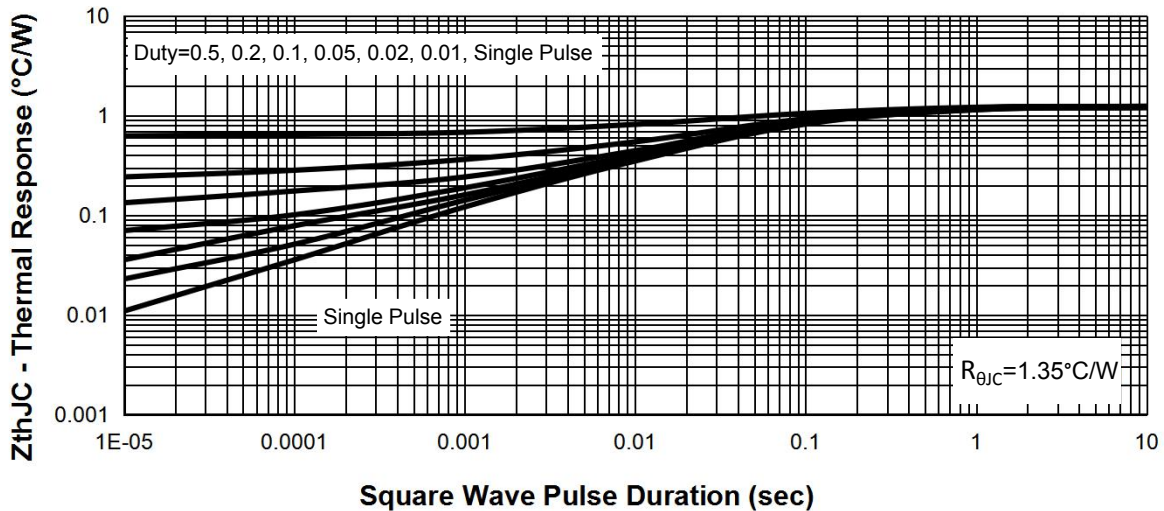

Typical Characteristics

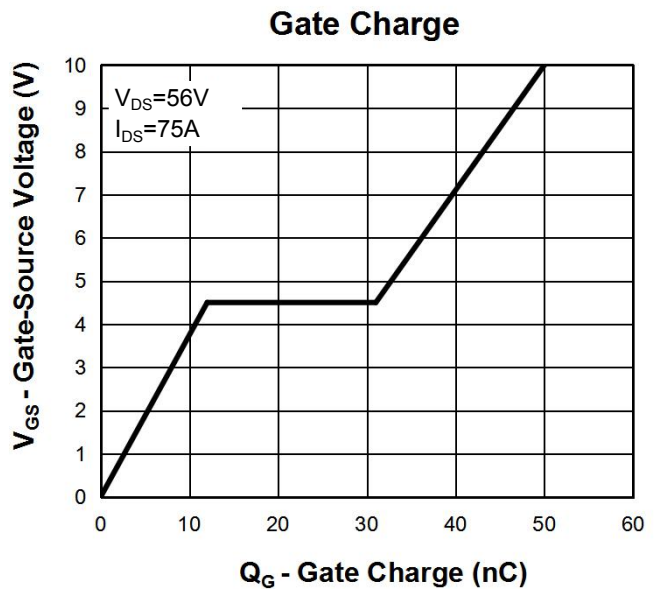
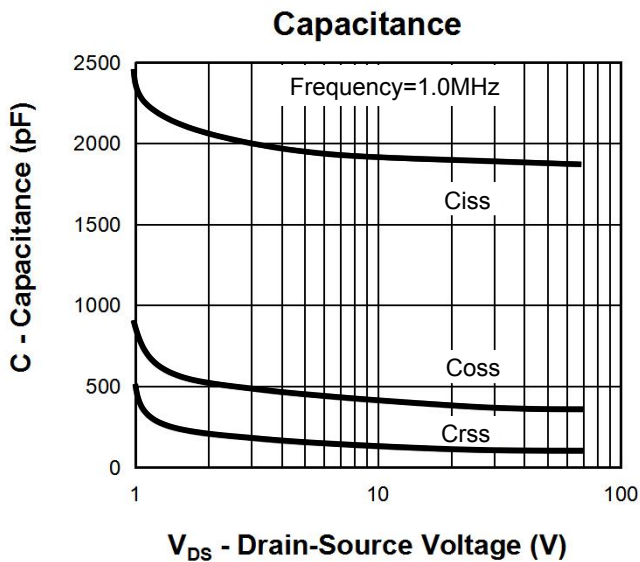
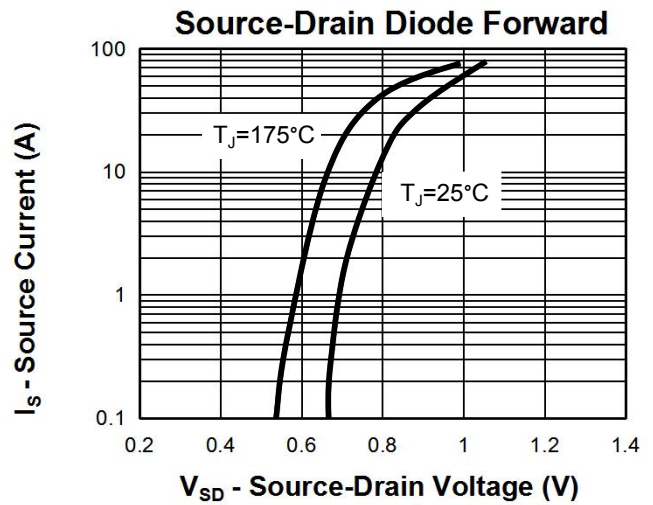
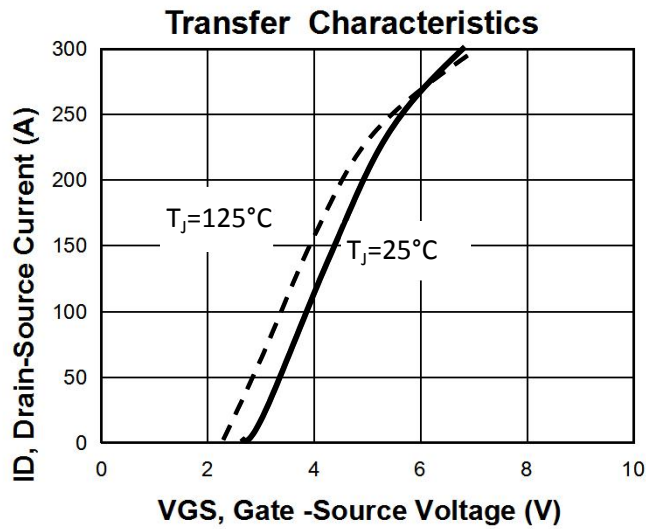
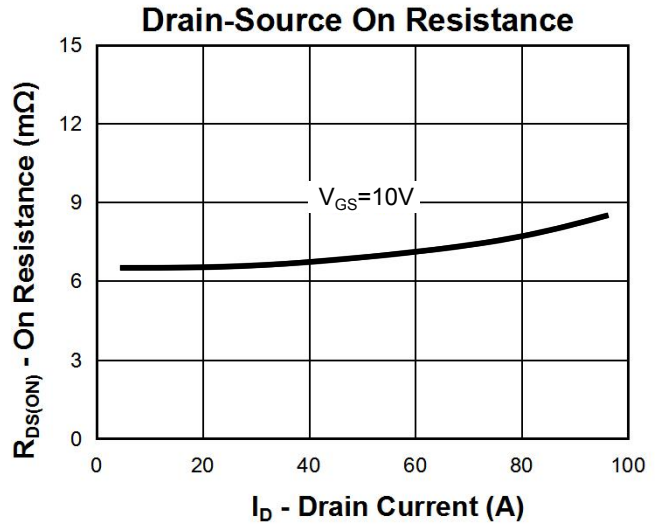
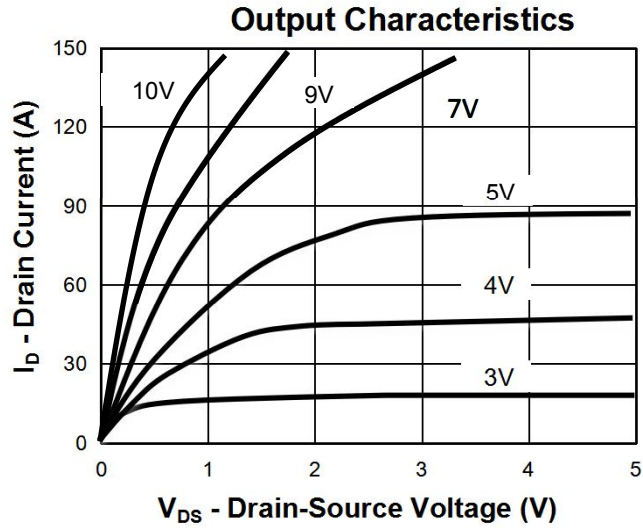

Avalanche Test Circuit and Waveforms

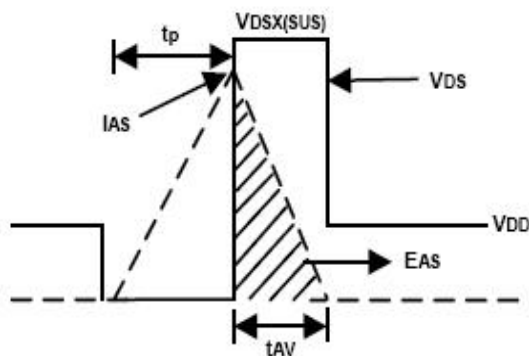
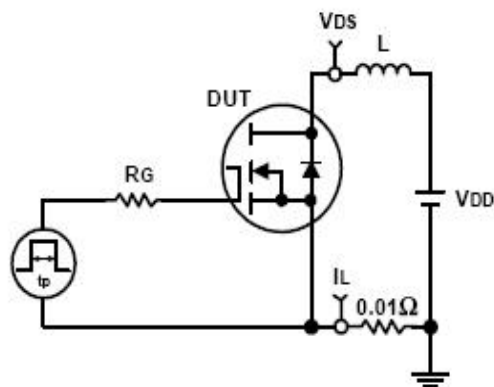

Switching Time Test Circuit and Waveforms

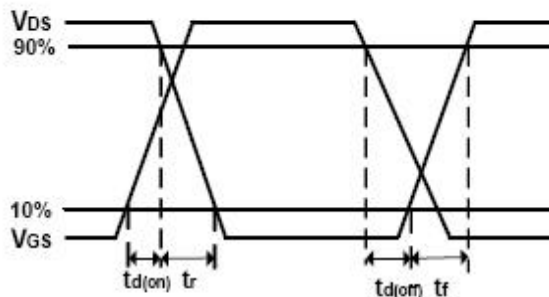
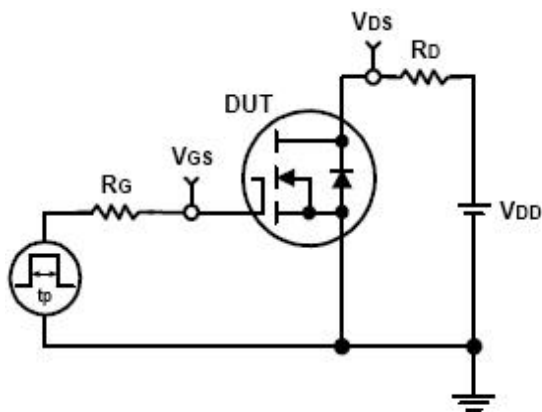

Ordering and Marking Information

Device	Marking	Package	Packaging	Quantity	Reel Size	Tape width
RU7080S	RU7080S	TO263	Tube	50	-	-
RU7080S-R	RU7080S	TO263	Tape&Reel	800	13"	24mm

Package Information

TO263

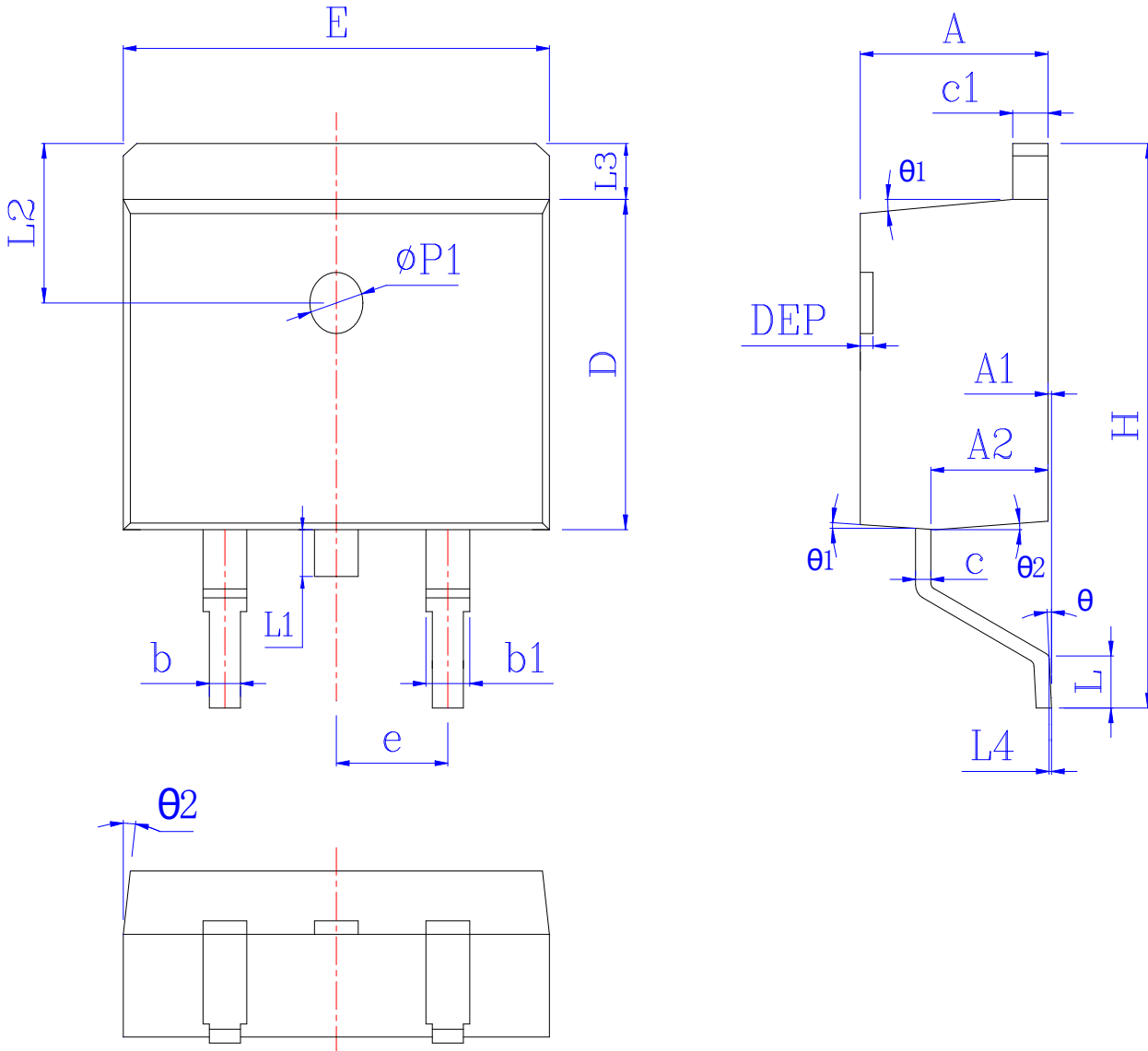

SYMBOL	MM			INCH			SYMBOL	MM			INCH		
	MIN	NOM	MAX	MIN	NOM	MAX		MIN	NOM	MAX	MIN	NOM	MAX
A	4.30	4.55	4.85	0.169	0.179	0.191	L	1.94	2.30	2.79	0.076	0.091	0.110
A1	0.00	0.10	0.25	0.000	0.005	0.010	L3	1.02	1.29	1.40	0.040	0.051	0.055
A2	2.20	2.69	2.79	0.087	0.106	0.110	L1	*	*	1.70	*	*	0.067
b	0.70	*	1.00	0.028	*	0.039	L4	0.25 BSC			0.01 BSC		
b1	1.14	*	1.47	0.045	*	0.058	L2	2.50 REF			0.098 REF		
c	0.33	*	0.65	0.013	*	0.026	θ	0°	*	8°	0°	*	8°
c1	1.15	*	1.45	0.045	*	0.057	θ_1	5°	7°	9°	5°	7°	9°
D	8.59	*	9.40	0.338	*	0.370	θ_2	1°	3°	5°	1°	3°	5°
E	9.66	*	10.40	0.380	*	0.409	DEP	0.05	0.10	0.20	0.002	0.004	0.008
e	2.54BSC			0.100BSC			$\Phi p1$	1.40	1.50	1.60	0.055	0.059	0.063
H	14.70	15.10	15.79	0.579	0.594	0.622							