

### Features

- 100V/150A,  
 $R_{DS(ON)} = 3.8m\Omega(Typ.)@V_{GS}=10V$
- Advanced HEFET<sup>®</sup> Technology
- Ultra Low On-Resistance
- Excellent  $Q_g \times R_{DS(on)}$  Product
- 100% avalanche tested
- 175°C Operating Temperature
- Lead Free and Green Devices Available (RoHS Compliant)



### Applications

- Motor Drives
- Uninterruptible Power Supplies
- DC/DC converter
- General Purpose Applications

### Pin Description

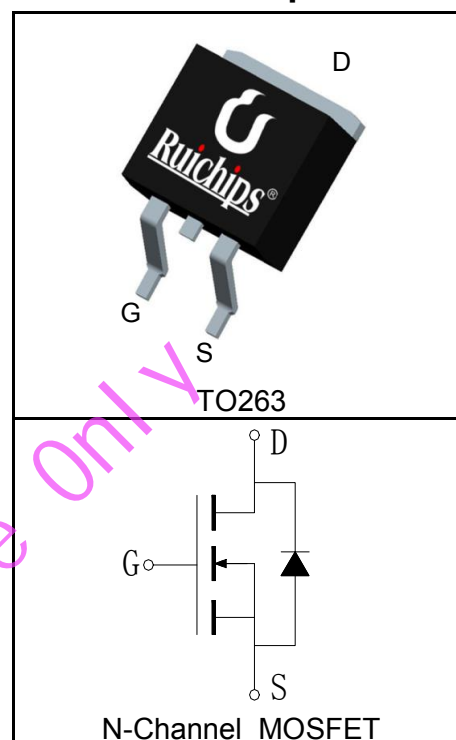

### Absolute Maximum Ratings

Symbol	Parameter	Rating	Unit
<b>Common Ratings</b> ( $T_C=25^\circ\text{C}$ Unless Otherwise Noted)			
$V_{DSS}$	Drain-Source Voltage	100	V
$V_{GSS}$	Gate-Source Voltage	$\pm 25$	
$T_J$	Maximum Junction Temperature	175	$^\circ\text{C}$
$T_{STG}$	Storage Temperature Range	-55 to 175	$^\circ\text{C}$
$I_S$	Diode Continuous Forward Current	$T_C=25^\circ\text{C}$ 150	A
<b>Mounted on Large Heat Sink</b>			
$I_{DP}^{①}$	300 $\mu\text{s}$ Pulse Drain Current Tested	$T_C=25^\circ\text{C}$ 600	A
$I_D^{②}$	Continuous Drain Current( $V_{GS}=10V$ )	$T_C=25^\circ\text{C}$ 150	A
		$T_C=100^\circ\text{C}$ 106	
$P_D$	Maximum Power Dissipation	$T_C=25^\circ\text{C}$ 200	W
		$T_C=100^\circ\text{C}$ 100	
$R_{\theta JC}$	Thermal Resistance-Junction to Case	0.75	$^\circ\text{C}/\text{W}$
$R_{\theta JA}$	Thermal Resistance-Junction to Ambient	62.5	$^\circ\text{C}/\text{W}$
<b>Drain-Source Avalanche Ratings</b>			
$E_{AS}^{③}$	Avalanche Energy, Single Pulsed	225	mJ

**Electrical Characteristics** ( $T_C=25^{\circ}\text{C}$  Unless Otherwise Noted)

Symbol	Parameter	Test Condition	RUH1H150S			Unit
			Min.	Typ.	Max.	
<b>Static Characteristics</b>						
$BV_{DSS}$	Drain-Source Breakdown Voltage	$V_{GS}=0V, I_{DS}=250\mu A$	100			V
$I_{DSS}$	Zero Gate Voltage Drain Current	$V_{DS}=100V, V_{GS}=0V$			1	$\mu A$
		$T_J=125^{\circ}\text{C}$			30	
$V_{GS(th)}$	Gate Threshold Voltage	$V_{DS}=V_{GS}, I_{DS}=250\mu A$	2		4	V
$I_{GSS}$	Gate Leakage Current	$V_{GS}=\pm 25V, V_{DS}=0V$			$\pm 100$	nA
$R_{DS(ON)}^{(4)}$	Drain-Source On-state Resistance	$V_{GS}=10V, I_{DS}=75A$		3.8	4.5	m $\Omega$
<b>Diode Characteristics</b>						
$V_{SD}^{(4)}$	Diode Forward Voltage	$I_{SD}=75A, V_{GS}=0V$			1.2	V
$t_{rr}$	Reverse Recovery Time	$I_{SD}=75A, di_{SD}/dt=100A/\mu s$		36		ns
$Q_{rr}$	Reverse Recovery Charge			285		nC
<b>Dynamic Characteristics</b> <sup>(5)</sup>						
$R_G$	Gate Resistance	$V_{GS}=0V, V_{DS}=0V, F=1\text{MHz}$		2.1		$\Omega$
$C_{iss}$	Input Capacitance	$V_{GS}=0V,$ $V_{DS}=50V,$ Frequency=1.0MHz		3650		pF
$C_{oss}$	Output Capacitance			750		
$C_{riss}$	Reverse Transfer Capacitance			27		
$t_{d(ON)}$	Turn-on Delay Time			24		
$t_r$	Turn-on Rise Time	$V_{DD}=50V, I_{DS}=75A,$ $V_{GEN}=10V, R_G=2.5\Omega$		13		
$t_{d(OFF)}$	Turn-off Delay Time			49		
$t_f$	Turn-off Fall Time			17		
<b>Gate Charge Characteristics</b> <sup>(5)</sup>						
$Q_g$	Total Gate Charge	$V_{DS}=80V, V_{GS}=10V,$ $I_{DS}=75A$		87		nC
$Q_{gs}$	Gate-Source Charge			23		
$Q_{gd}$	Gate-Drain Charge			15		

## Notes:

- ① Pulse width limited by safe operating area.
- ② Calculated continuous current based on maximum allowable junction temperature. The package limitation current is 75A.
- ③ Limited by  $T_{Jmax}$ ,  $I_{AS}=30A$ ,  $V_{DD}=60V$ ,  $R_G=50\Omega$ , Starting  $T_J=25^{\circ}\text{C}$ .
- ④ Pulse test; Pulse width  $\leq 300\mu s$ , duty cycle  $\leq 2\%$ .
- ⑤ Guaranteed by design, not subject to production testing.

**Typical Characteristics**

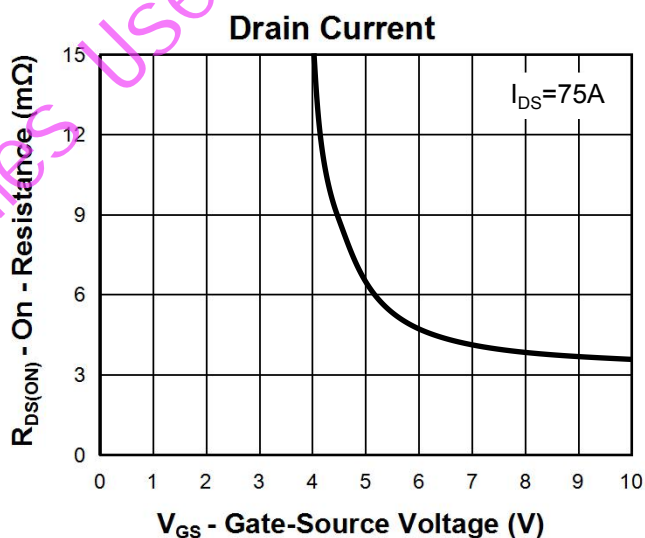
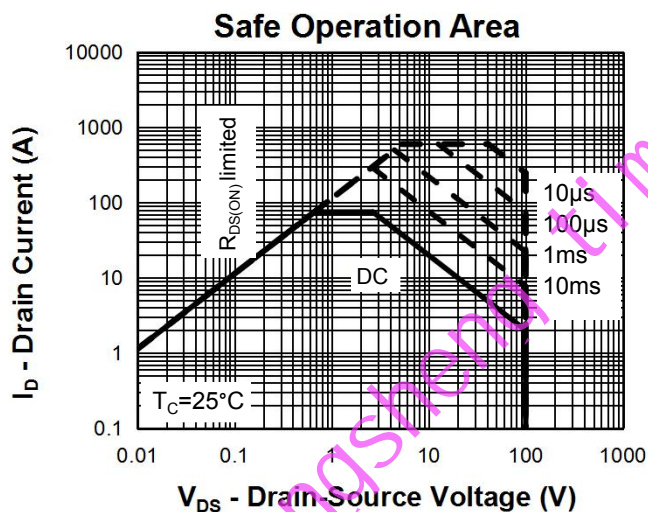
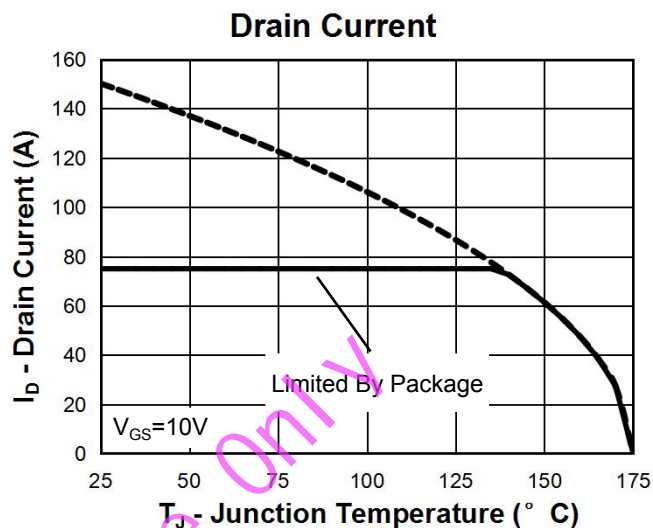
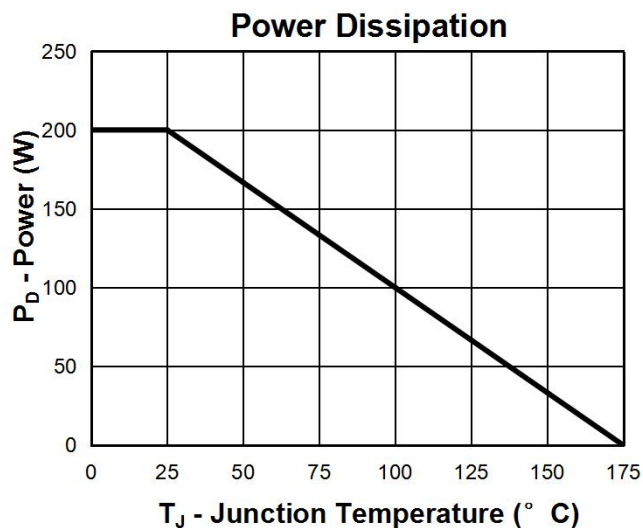

**Thermal Transient Impedance**

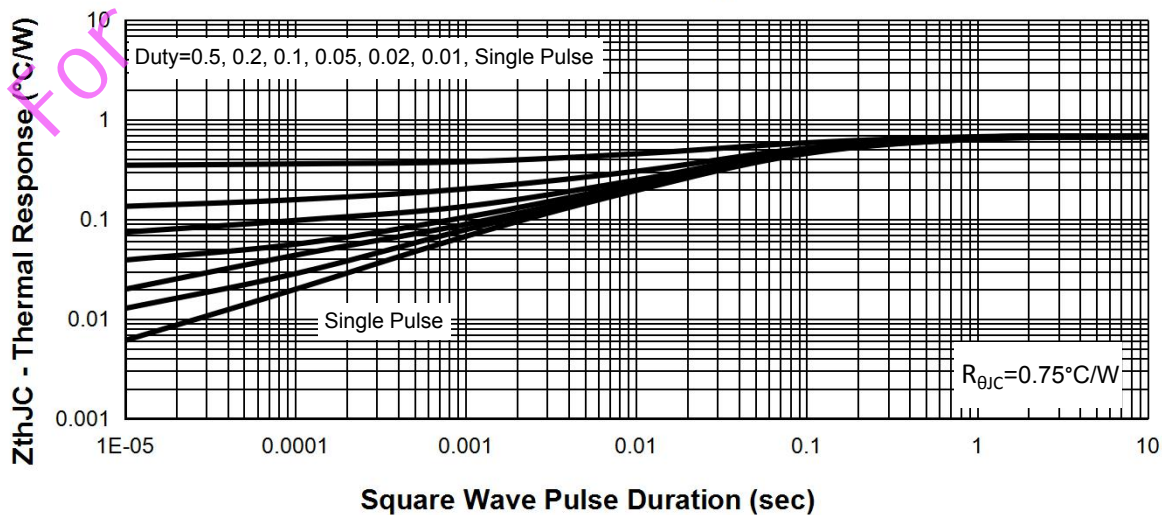

**Typical Characteristics**

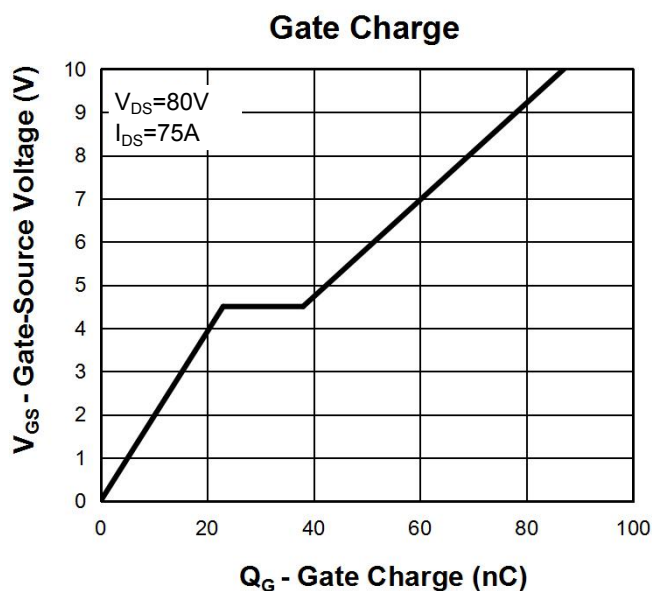
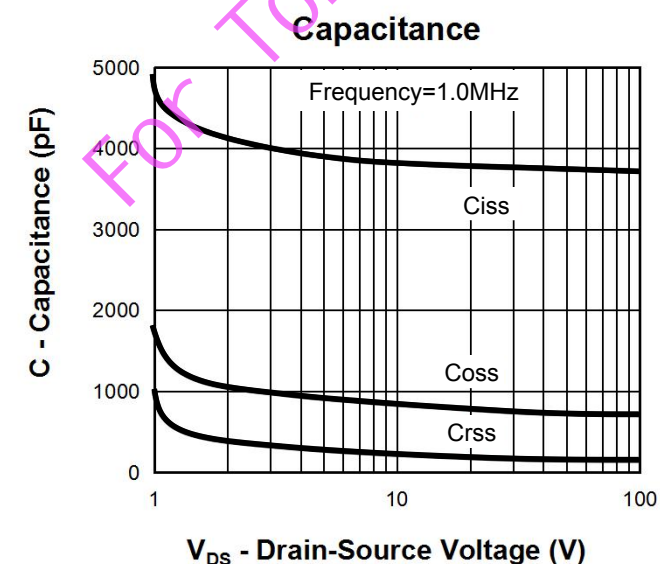
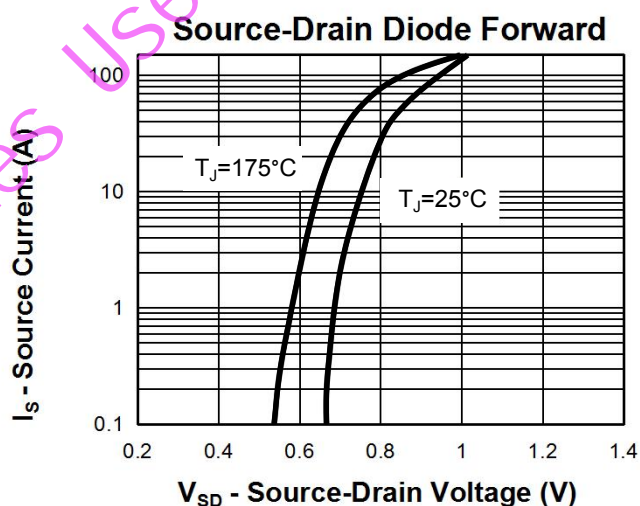
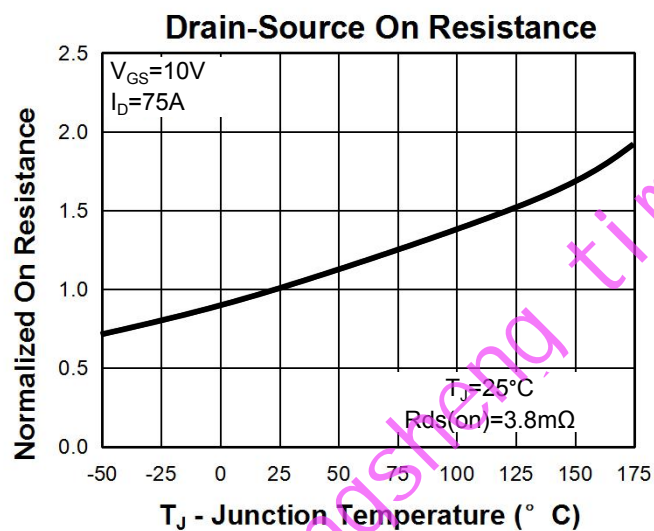
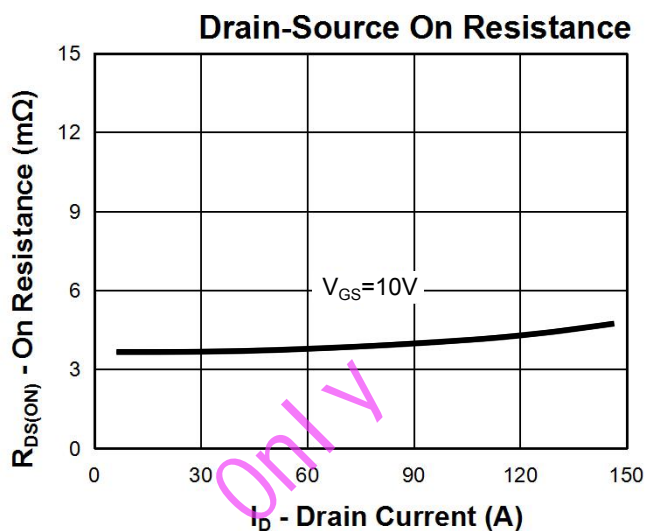
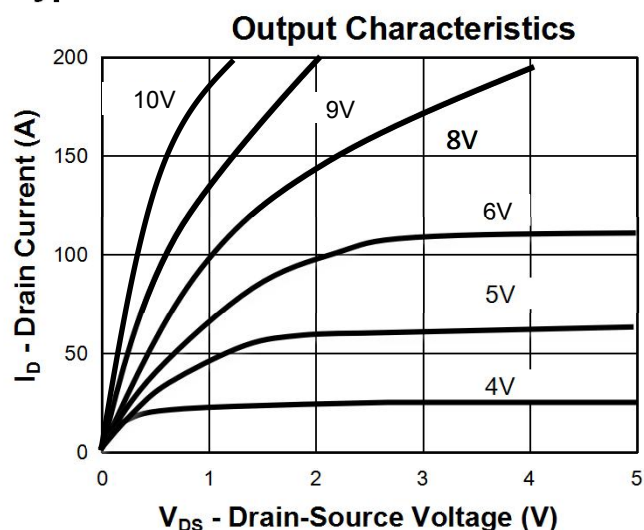

**Avalanche Test Circuit and Waveforms**

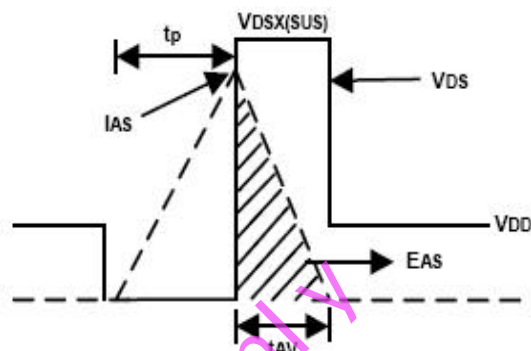
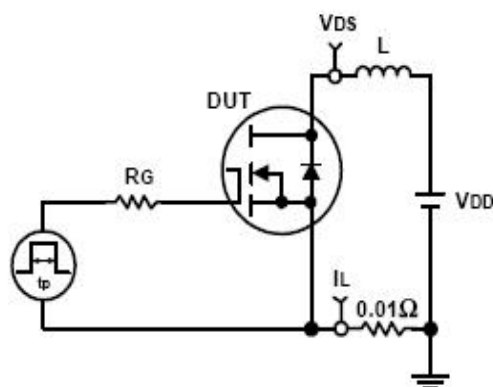

**Switching Time Test Circuit and Waveforms**

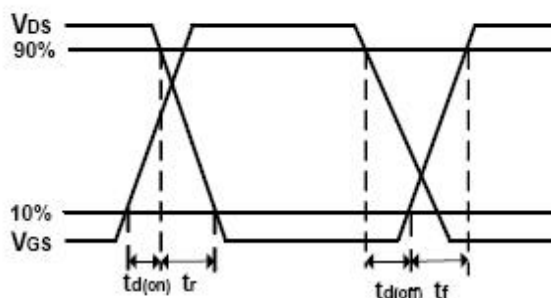
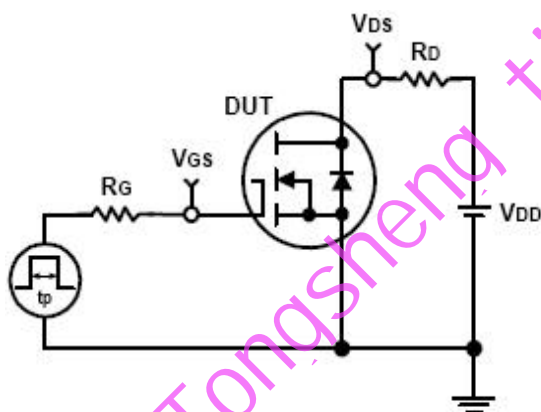

**Ordering and Marking Information**

Device	Marking	Package	Packaging	Quantity	Reel Size	Tape width
RUH1H150S	RUH1H150S	TO263	Tube	50	-	-
RUH1H150S-	RUH1H150S	TO263	Tape&Reel	800	13"	24mm

**Package Information**

**TO263**

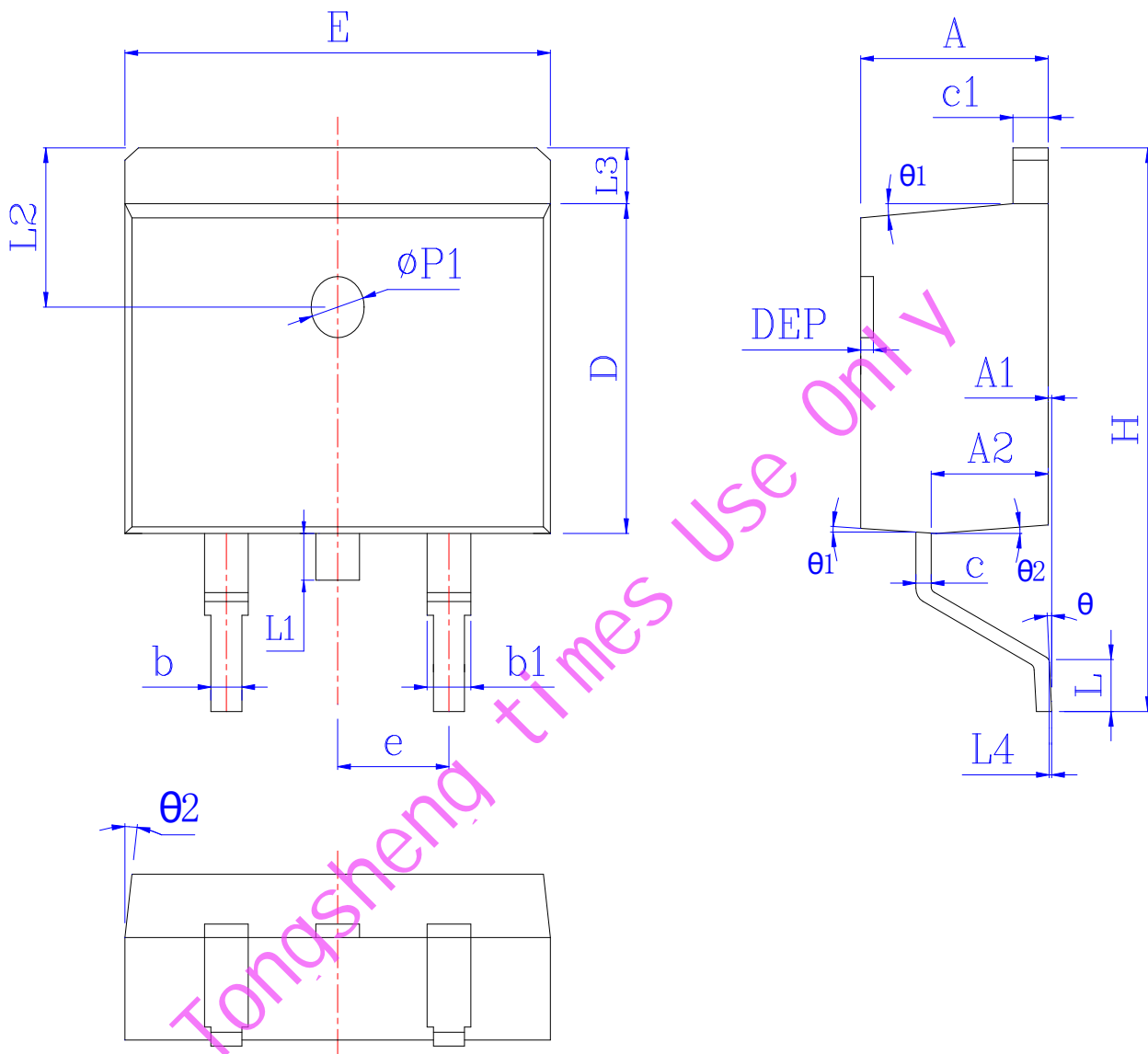

SYMBOL	MM			INCH			SYMBOL	MM			INCH		
	MIN	NOM	MAX	MIN	NOM	MAX		MIN	NOM	MAX	MIN	NOM	MAX
A	4.30	4.55	4.85	0.169	0.179	0.191	L	1.94	2.30	2.79	0.076	0.091	0.110
A1	0.00	0.10	0.25	0.000	0.005	0.010	L3	1.02	1.29	1.40	0.040	0.051	0.055
A2	2.20	2.69	2.79	0.087	0.106	0.110	L1	*	*	1.70	*	*	0.067
b	0.70	*	1.00	0.028	*	0.039	L4	0.25 BSC			0.01 BSC		
b1	1.14	*	1.47	0.045	*	0.058	L2	2.50 REF			0.098 REF		
c	0.33	*	0.65	0.013	*	0.026	$\theta$	0°	*	8°	0°	*	8°
c1	1.15	*	1.45	0.045	*	0.057	$\theta 1$	5°	7°	9°	5°	7°	9°
D	8.59	*	9.40	0.338	*	0.370	$\theta 2$	1°	3°	5°	1°	3°	5°
E	9.66	*	10.40	0.380	*	0.409	DEP	0.05	0.10	0.20	0.002	0.004	0.008
e	2.54BSC			0.100BSC			$\Phi p1$	1.40	1.50	1.60	0.055	0.059	0.063
H	14.70	15.10	15.79	0.579	0.594	0.622							