

Product Features

- GaN on SiC Broadband High Power Amplifier
- 1000 to 2000MHz Operation Bandwidth
- Small Signal Gain 29dB min.
- 20W Typical. P3dB

Application

- UHF/Military



Package : DP-75

Description

The power amplifier module is designed for Broadcasting, Telecommunication, Medical, Military and Other markets.

Operating frequency range is from 1000MHz to 2000MHz

Gallium Nitride on SiC technology is used and attached on an aluminum sub carrier. Full in/out matching for broadband performance is already applied.

Improved thermal handling by patented technology.

Typical Specifications
 $V_{CC} = +28V; T = 25^{\circ}C; Z_S = Z_L = 50\Omega$

No	Item	Conditions	Min	Typ	Max	Unit
1	Bandwidth		1000		2000	MHz
2	Small Signal Gain		27	29	31	dB
3	Gain Variation vs Temperature	-20°C to 60°C	-2		+2	dB
4	Gain Variation vs Frequency			±1	±2	dBpp
5	P _{3dB}	1000MHz to 1200MHz	41	43		dBm
		1200MHz to 2000MHz	42	44		
6	OIP3 @ P _o = +33dBm (1MHz Tone spacing, CW 2-Tone)	1000MHz to 1600MHz	48	50		dBm
		1600MHz to 2000MHz	46	48		
7	Input Return Loss			-10	-6	dB
8	Output Return Loss			-10	-5	dB
9	2 nd Harmonic suppression	CW 1-tone @P _o = +30dBm, Freq 1000MHz		-35	-28	dBc
10	Supply Voltage	V _{cc} (=V _{ds})	27.5	28	30	V
11	Quiescent Current consumption			2.2	2.5	A
12	Current Consumption @ P _{3dB}	CW 1-tone			3.6	A
13	On/Off Switching Time	On : TTL "Low"		3	5	uS
		Off : TTL "High"(100mA@Disable)				
14	Shut Down or Switch On/Off TTL Voltage	On : TTL "Low"(Enable)	0		0.5	V
		Off : TTL "High"	2.5	5	5.5	

Environmental Characteristics

No	Item	Min	Typ	Max	Unit
1	Operating Temperature	-20		+60	°C
2	Storage Temperature	-40		+105	°C
3	Vibration	MIL-STD-810G Method 514.6 ANNEX C			

Absolute Maximum Ratings

No	Item	Rating	Unit
1	Operating Flange Temperature	+85	°C
2	Input RF Power	+20	dBm
3	Supply Voltage	+30	V
4	Load Mismatch Value	3 : 1 @all load phase	

* Input Signal Condition : CW 1-Tone

Ordering Information

No	Part Number	Package
1	RWP15020-10	Pallet
2	RWP15020-1H	Module assembled with RWP05020-10

* RWP15020-1H is a SMA connectorized housing version of RWP15020-10. Electrical parameters are all same as RWP15020-10.

For more information, please contact RFHIC

RWP15020-10 Typical Performance @ 25°C

Frequency (MHz)	P1dB (dBm)	P3dB (dBm)	Current@P1dB (A)	Current@P3dB (A)	2nd Harm @30dBm(dBc)	OIP3 (30dBm/Tone)
1000	39.4	42.5	2.3	2.9	-34.7	49.5
1100	39.8	42.9	2.4	3.1	-43.5	49.8
1200	40.6	43.8	2.1	3.3	-49.4	50.4
1300	41.5	44.5	2.5	3.3	-47.7	50.8
1400	42.1	44.5	2.5	3.3	-43.3	51.0
1500	42.3	45.2	2.5	3.2	-41.8	51.1
1600	43.0	45.4	2.4	3.0	-43.8	51.0
1700	43.2	45.4	2.3	2.7	-46.1	50.3
1800	42.6	44.8	2.1	2.5	-49.6	49.5
1900	42.4	44.3	2.0	2.3	-52.7	48.5
2000	42.0	43.9	2.0	2.3	-61.3	47.6

P3dB

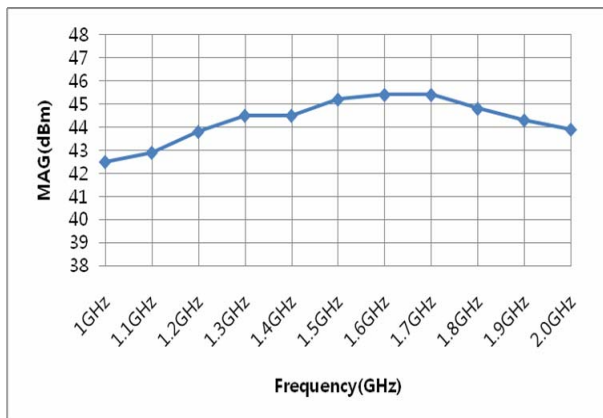

2nd Harmonics

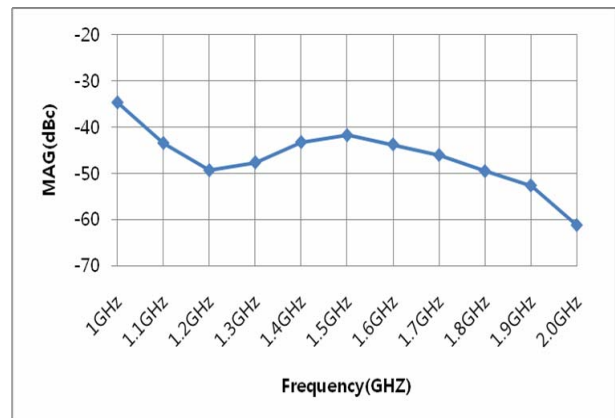

OIP3

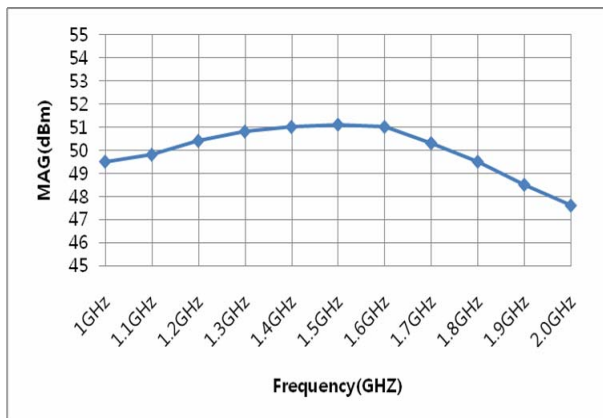

Power Gain @ Pin=18dBm

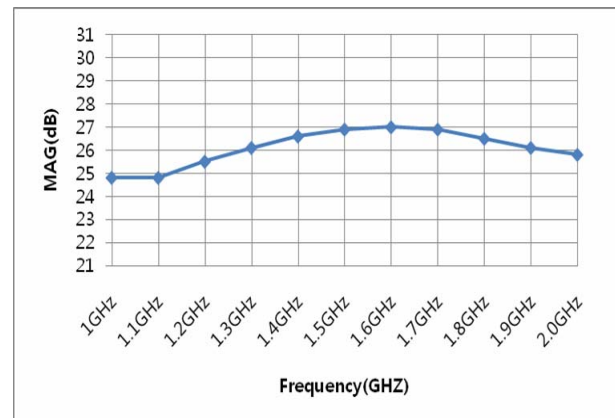

Precautions

1. This product is designed to be used for broadband amplification.

Heat generation is higher when there is no RF signal in the device. Therefore, the worst case scenario is when there is no RF signal, and the amplifier is “on” with current draw. The temperature must be calculated properly.

Case temperature must maintain below 85°C.

2. Thermal Grease or Metal Thermal Interface Materials are recommended for heat dissipation.

An example would be spreading thermal grease on the bottom of the device.

Package Dimensions (Type: DP-75)

(Unit : mm/[inch], Tolerance : ±0.2/[.008])

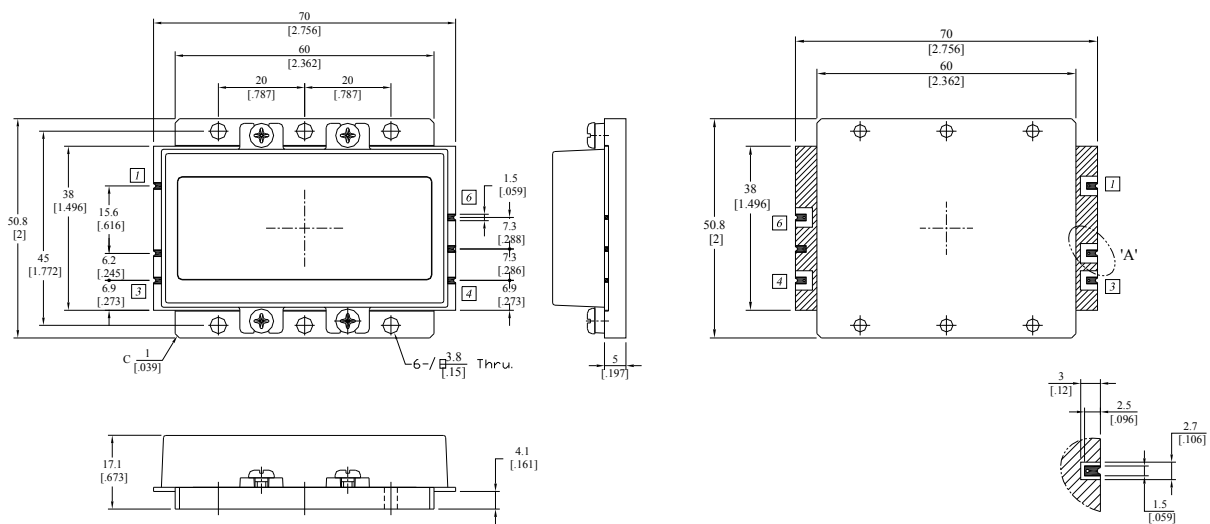

How to connect the amplifier to a target PCB

Method-I (with Pin)

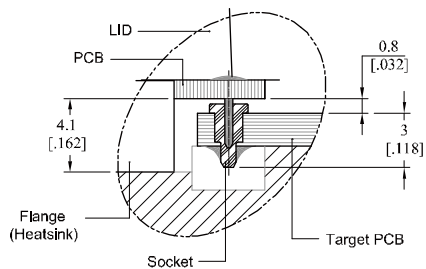

Method-II (without Pin) - If you cut out the pin

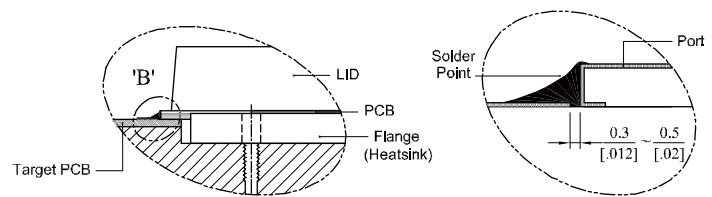

Pin Description

Pin No	Port Name	Function
1	RF IN	RF Input
2	Vcc(+28V)	DC Supply
3	Shut Down(+5V)	Shut Down @ TTL High, Enable @ TTL Low
4	Switch ON/OFF	Disable @ TTL High (Switch Status : Off)
5	GND	Ground
6	RF OUT	RF Output

* Terminal Pin Information : ASK206091,AA (Acethink, Pin) , ASK20556,AA-1(Acethink, Pin Socket)

* Recommended Screw Torque : 8.0kgf.cm±1 using SEMS M3 10mm Bolt

Note :

RFHIC Corporation (RFHIC) reserves the right to make changes to any products herein or to discontinue any product at any time without notice. RFHIC do not assume any liability for the suitability of its products for any particular purpose, and disclaims any and all liability, including without limitation consequential or incidental damages. The product specifications herein expressed have been carefully checked and are assumed to be reliable. However, RFHIC disclaims liability for inaccuracies and strongly recommends buyers to verify that the information they are using is current before placing purchase orders. RFHIC products are not intended for use in life support equipment or application where malfunction of the product can be expected to result in personal injury or death. Buyer uses or sells such products for any such unintended or unauthorized application, buyer shall indemnify, protect and hold RFHIC and its directors, officers, stockholders, employees, representatives and distributors harmless against any and all claims arising out of such use. RFHIC's liability under or arising out of damages, claims of whatsoever kind and nature which RFHIC products could cause shall be limited in amount to the net purchase price of the products sold to buyer by RFHIC.