

OPERATING INSTRUCTIONS

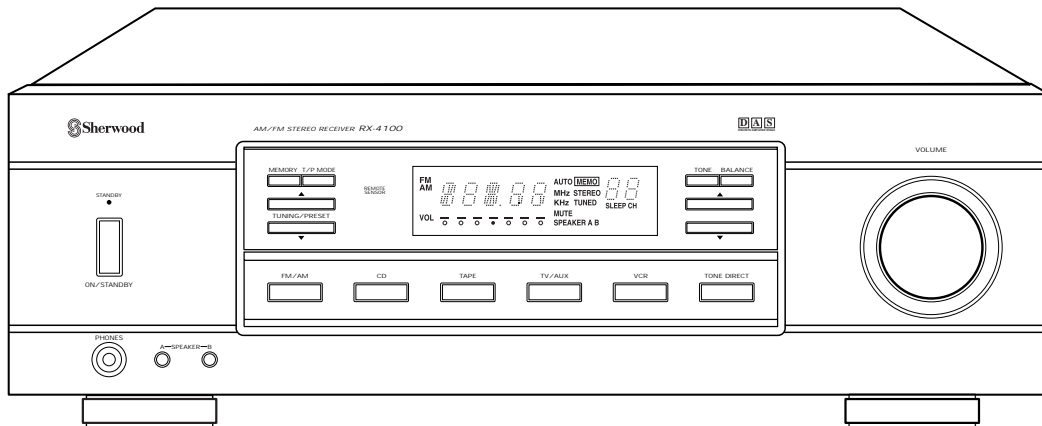

www.DataSheet.in



RX-4100

AM/FM STEREO RECEIVER

Introduction



UNPACKING AND

ENGLISH

Congratulations on Your Purchase!

Your new high fidelity receiver is designed to deliver maximum enjoyment and years of trouble free service. Please take a few moments to read this manual thoroughly. It will explain the features and operation of your unit and help ensure a trouble free installation. Please unpack your unit carefully. We recommend that you save the carton and packing material. They will be helpful if you ever need to move your unit and may be required if you ever need to return it for service. Your unit is designed to be placed in a horizontal position and it is important to allow at least two inches of space behind your unit for adequate ventilation and cabling convenience.

To avoid damage, never place the unit near radiators, in front of heating vents, in direct sunlight, or in excessively humid or dusty locations. Connect your complementary components as illustrated in the following section.

	CAUTION RISK OF ELECTRIC SHOCK DO NOT OPEN	
CAUTION : TO REDUCE THE RISK OF ELECTRIC SHOCK, DO NOT REMOVE COVER (OR BACK). NO USER-SERVICEABLE PARTS INSIDE. REFER SERVICING TO QUALIFIED SERVICE PERSONNEL.		



This symbol is intended to alert the user to the presence of uninsulated "dangerous voltage" within the product's enclosure that may be of sufficient magnitude to constitute a risk of electric shock to persons.



This symbol is intended to alert the user to the presence of important operating and maintenance (servicing) instructions in the literature accompanying the appliance.

WARNING

To reduce the risk of fire or electric shock, do not expose this appliance to rain or moisture.

Caution : Do not block ventilation openings or stack other equipment on the top.

FOR U.S.A.

■ **Note to CATV System Installer:** This reminder is provided to call the CATV system installer's attention to Article 820-40 of the NEC that provides guidelines for proper grounding and, in particular, specifies that the cable ground shall be connected to the grounding system of the building, as close to the point of cable entry as practical.

■ **FCC INFORMATION**

This equipment has been tested and found to comply with the limits for a Class B digital device, pursuant to Part 15 of the FCC Rules. These limits are designed to provide reasonable protection against harmful interference in a residential installation. This equipment generates, uses and can radiate radio frequency energy and, if not installed and used in accordance with the instructions, may cause harmful interference to radio communications. However, there is no guarantee that interference will not occur in a particular installation. If this equipment does cause harmful interference to radio or television reception, which can be determined by turning the equipment off and on, the user is encouraged to try to correct the interference by one or more of the following measures:

- Reorient or relocate the receiving antenna.
- Increase the separation between the equipment and receiver.
- Connect the equipment into an outlet on a circuit different from that to which the receiver is connected.
- Consult the dealer or an experienced radio/TV technician for help.

CAUTION: Any changes or modifications in construction of this device which are not expressly approved by the party responsible for compliance could void the user's authority to operate the equipment.

Caution regarding placement (Except for U.S.A. and Canada)

To maintain proper ventilation, be sure to leave a space around the unit (from the largest outer dimensions including projections) equal to, or greater than, shown below.

Left and right panels: 5 cm
Rear panel: 10 cm
Top panel: 20 cm



READ THIS BEFORE OPERATING

FOR U.S.A. AND CANADA 120 V

FOR YOUR SAFETY

Units shipped to the U.S.A. and Canada are designed for operation on 120 V AC only.

Safety precaution with use of a polarized AC plug. However, some products may be supplied with a nonpolarized plug.

CAUTION : *To prevent electric shock, match wide blade of plug to wide slot, fully insert.*

ATTENTION : *Pour éviter les choc électriques, introduire la lame la plug large de la borne correspondante de la prise et pousse jusqu'au fond.*

FOR CHINA, EUROPE AND AUSTRALIA 220V/230V/240V

FOR YOUR SAFETY

Units shipped to China are designed for operation on 220 V AC only.

Units shipped to Australia are designed for operation on 240 V AC only.

To ensure safe operation, the three-pin plug supplied must be inserted only into a standard three-pin power point which is effectively earthed through the normal household wiring. Extension cords used with the equipment must be three-core and be correctly wired to provide connection to earth.

Improper extension cords are a major cause of fatalities. The fact that the equipment operates satisfactorily does not imply that the power point is earthed and that the installation is completely safe. For your safety, if in any doubt about the effective earthing of the power point, consult a qualified electrician.

PAN-EUROPEAN UNIFIED VOLTAGE

All units are suitable for use on supplies 230-240 V AC.

FOR OTHER COUNTRIES 115 V/230 V

FOR YOUR SAFETY

Units shipped to countries other than the above countries are equipped with an AC voltage selector switch on the rear panel. Refer to the following paragraph for the proper setting of this switch.

AC VOLTAGE SELECTION

This unit operates on 115/230 V AC. The AC voltage selector switch on the rear panel is set to the voltage that prevails in the area to which the unit is shipped. Before connecting the power cord to your AC outlet, make sure that the setting position of this switch matches your line voltage. If not, it must be set to your voltage in accordance with the following direction.

AC voltage selector switch

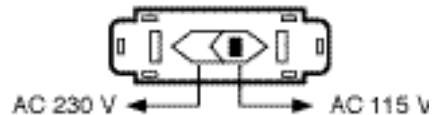

Move switch lever to match your line voltage with a small screwdriver or other pointed tool.

CONTENTS

Introduction

- UNPACKING AND INSTALLATION 2
- READ THIS BEFORE OPERATING YOUR UNIT..... 3

System Connections 5

Front Panel & Remote Controls 7

- REMOTE CONTROL OPERATION RANGE 9
- LOADING BATTERIES 9

Operations

- LISTENING TO A PROGRAM SOURCE 10
- LISTENING TO RADIO BROADCASTS 12
- RECORDING 14
- OTHER FUNCTIONS 14

Troubleshooting Guide 15

Specifications 16

System Connections

- Do not plug the AC input cord into the wall AC outlet until all connections are completed.
- Be sure to connect the white RCA pin cord to the L(left) and the red RCA pin cord to the R(right) jacks when making audio connections.
- Change the position of the FM indoor antenna until you get the best reception of your favorite FM stations.
- A 75 Ω outdoor FM antenna may be used to further improve the reception.
Disconnect the indoor antenna before replacing it with the outdoor one.
- Place the AM loop antenna as far as possible from the receiver, TV set, speaker cords and the AC input cord and set it to a direction for the best reception.
- If the reception is poor with the AM loop antenna, an AM outdoor antenna can be used in place of the AM loop antenna.
- Make connections firmly and correctly. If not, it can cause loss of sound, noise or damage to the receiver.
- If the electricity fails or the AC input cord is left unplugged for more than 2 weeks, the memorized contents will be cleared. Should this happen, memorize them again.

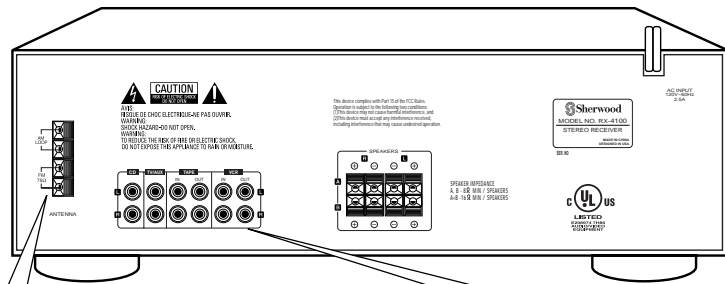

CONNECTING ANTENNAS

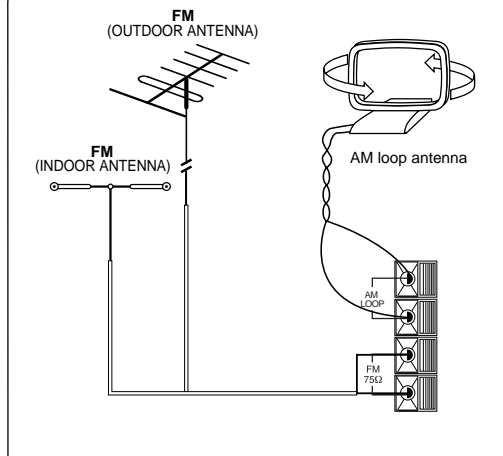

CONNECTING AUDIO/VIDEO COMPONENTS

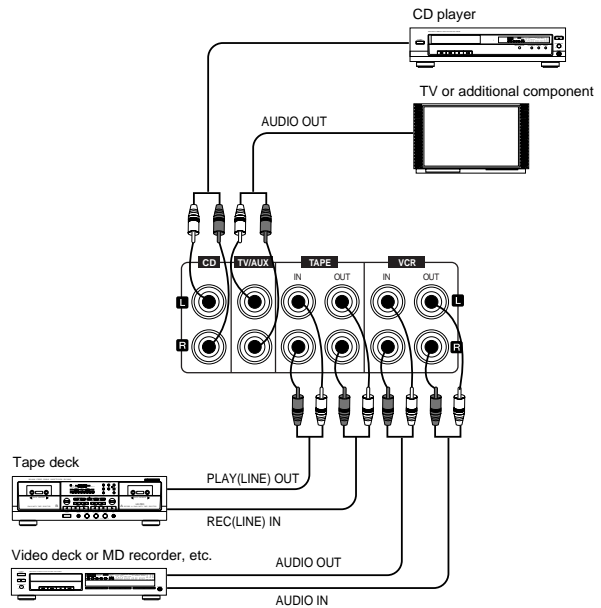

- The VCR jacks may also be connected to an additional component such as MD recorder, tape deck, etc.
- The TV/AUX jacks may also be connected to an additional component such as a TV, DVD player, etc.

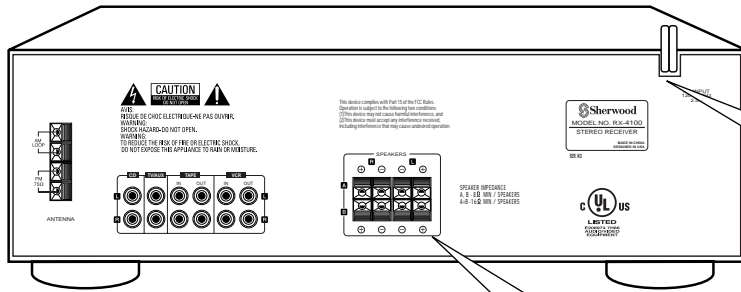

■ AC INPUT CORD

Plug this cord into a wall AC outlet.

■ CONNECTING SPEAKERS

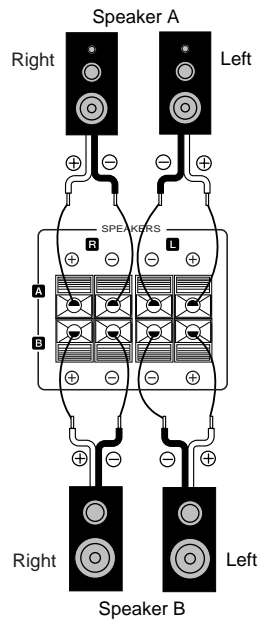

- Usually SPEAKER A terminals are used for only a pair of speakers. When you have another pair of speakers, SPEAKER B terminals can be used.
- Never short-circuit the + and - speaker cords.
- Be sure to connect speakers firmly and correctly according to the channel (left and right) and the polarity (+ and -).
Note :
- For safe amplifier operation, use the speakers with impedance of over 8Ω when you use only SPEAKER A or B terminals and use the speakers with impedance of over 16Ω when you use both SPEAKER A and B terminals.

Front Panel & Remote Controls

ENGLISH

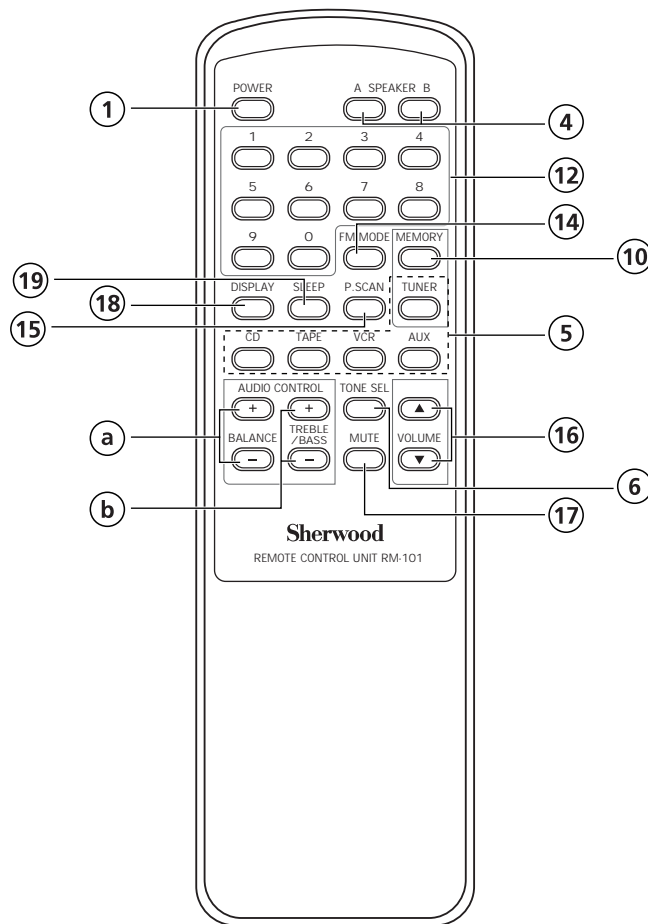
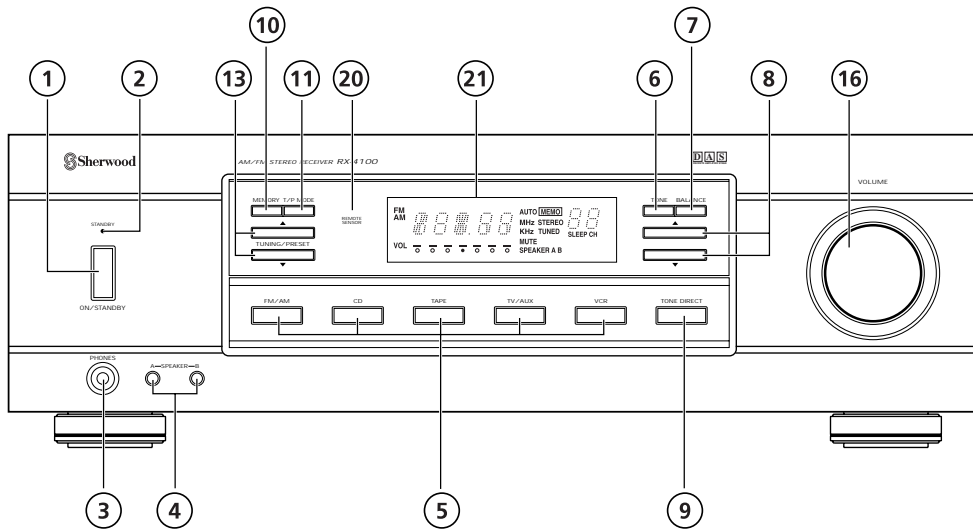

① POWER BUTTON

Press this button to turn the power on, then the STANDBY indicator goes off.
Press again this button to turn the power off, then the STANDBY indicator lights up.

② STANDBY INDICATOR**③ HEADPHONE JACK**

Stereo headphones with a standard 1/4 inch plug can be plugged into this jack for private listening.

④ SPEAKER A, B SELECTOR BUTTONS

These buttons allow you to select various combinations of speakers as follows:

- To drive A speakers, press only the SPEAKER A button (“SPEAKER A” lights up).
- To drive B speakers, press only the SPEAKER B button (“SPEAKER B” lights up).
- To drive both A and B speakers, press the SPEAKER A and B buttons (“SPEAKER A” and “B” light up).
- When using headphones for private listening, press these buttons to switch off the speaker A and B (“SPEAKER A” and “B” go off).

⑤ INPUT SELECTOR BUTTONS

Press the button to select the desired input source.

⑥ TONE BUTTON

When adjusting the tone (bass and treble), press this button to select the desired tone mode.

- Each time this button is pressed, the tone mode is changed to bass or treble.

⑦ BALANCE BUTTON

When adjusting the sound volume balance, press this button to enter the balance mode.

⑧ BALANCE, TREBLE/BASS UP/DOWN (▲/▼, +/-) BUTTONS

- a) At the balance mode, adjust the sound volume balance between left and right speakers with these buttons.
 - When the BALANCE +/- buttons on the remote control are pressed, it enters the balance mode automatically without pressing the BALANCE button on the front panel.
- b) At the desired tone mode, adjust the tone as desired with these buttons.

⑨ TONE DIRECT BUTTON

Press this button to listen to a program source without the tone effect.

⑩ MEMORY BUTTON

Press this button to store preset stations.

⑪ TUNING/PRESET MODE BUTTON

Press this button to select the tuning mode or the preset mode.

⑫ NUMERIC BUTTONS(0 ~ 9)

Press these buttons to select or to store preset stations directly.

⑬ TUNING/PRESET UP/DOWN(▲/▼) BUTTONS

Press these buttons to tune in the desired stations.

⑭ FM MODE BUTTON

Press this button to select the desired FM mode.

- Each time this button is pressed, the FM mode is changed to the stereo mode or the mono mode.

⑮ PRESET SCAN BUTTON

Press this button to scan the stations in the preset sequence.

⑯ VOLUME CONTROL KNOB, UP/DOWN(▲/▼) BUTTONS

Adjust the volume to a comfortable listening level with this knob or these buttons.

⑰ MUTE BUTTON

Press this button to temporarily mute the sound.
Press again to resume the previous sound level.

⑱ DISPLAY BUTTON

Press this button to select the brightness of unit’s display as desired.

- Each time this button is pressed, the brightness of unit’s display changes as follows:

→ ON → dim → OFF

⑲ SLEEP BUTTON

Press this button to activate the sleep timer for a specified period of time.

- Each time this button is pressed, the sleep time changes as follows:

→ 10 → 20 → 30 → 60 → 90 → OFF
Unit : minutes

㉑ REMOTE SENSOR

This receives the signals from the remote control unit.

㉒ FLUORESCENT DISPLAY

For details, see the next page.

■ FLUORESCENT DISPLAY

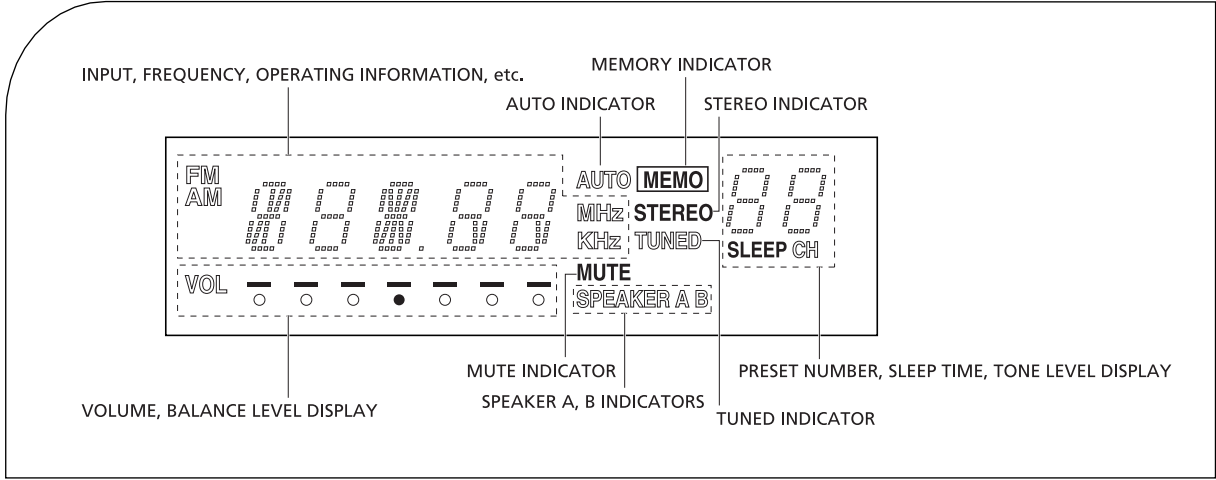

The diagram shows a car stereo with a remote control positioned below it. A cone of light from the remote is directed at the stereo's sensor. The range is labeled as 7m, and the angle is shown as 30° on both sides.

- Use the remote control unit within a range of about 7 meters (23 feet) and angles of up to 30 degrees aiming at the remote sensor.

1 Remove the cover.

The diagram shows the back of the device with an arrow pointing to a latch on the battery cover, indicating it should be pushed to open.

2 Load two batteries matching the polarity.

The diagram shows two 1.5V R6/SUM-3/AA batteries and a battery compartment with the correct polarity (+ and -) markings.

- Remove the batteries when they are not used for a long time.
- Do not use the rechargeable batteries(Ni-Cd type).

Operations

ENGLISH

LISTENING TO A PROGRAM

1

Turn the power on.

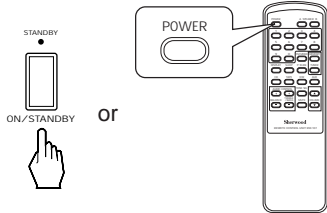

- The unit is turned on and enters the operating mode.
- To turn the power off, press the **POWER** button. Then it enters the standby mode and the **STANDBY** indicator lights up. This means that the unit is not disconnected from the AC mains and a small amount of current is retained to support the operation readiness.
- In the standby mode, if an **INPUT SELECTOR** button is pressed, the unit is turned on automatically and the desired input is selected.

4

Operate the selected component for playback.

5

Adjust the volume to a comfortable listening level.

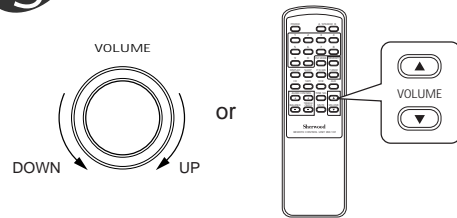

2

Switch the desired speakers on.

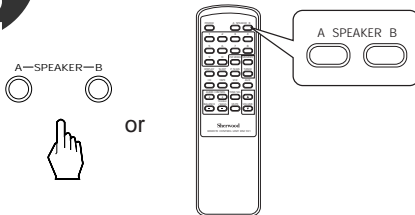

- Then the corresponding speaker indicator lights up and the sound can be heard from the speakers connected to the selected speaker terminals.
- When using the headphones for private listening, press the corresponding **SPEAKER** button to switch off both A and B speakers.

6

To mute the sound.

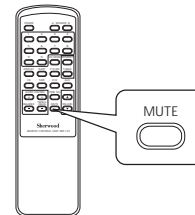

- “**MUTE**” lights up and “**SPEAKER**” flickers.
- To resume the previous sound level, press this button again.

3

Select the desired input source.

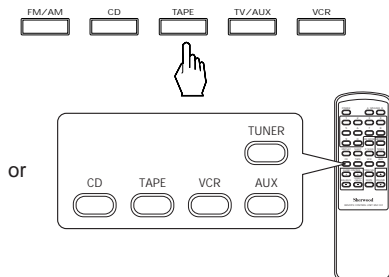

- Each time the **FM/AM** button on the front panel or the **TUNER** button on the remote control is pressed, the band is changed to AM or FM.

7

To listen with the headphones.

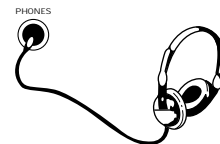

- Be sure to switch off both A and B speakers.

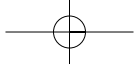

Adjusting the tone(bass and treble)

8 Enter the tone mode.

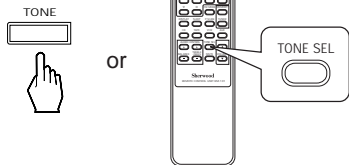

- Each time this button is pressed, the corresponding tone mode is selected and shown for 5 seconds as follows:

→ BAS(s) → TRE(ble) →

■Note:

- When the tone direct function is activated, the tone mode cannot be entered and “T-DIR” is displayed.

9 At the desired tone mode, adjust the tone as desired.

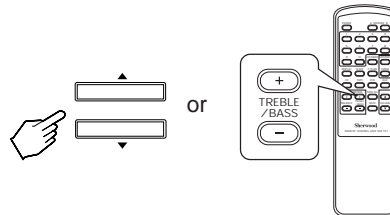

- If the tone display disappears, start from the step 8 again.

■Notes:

- Extreme settings at high volume may damage your speakers.
- In general, the bass and treble levels are adjusted to 0.

To listen to a program source without the tone effect.



- “T-DIR” is displayed and the sound that bypasses the tone circuitry will be heard.
- To cancel the tone direct function, press this button again to display “D-OFF”.

Adjusting the sound volume balance

Enter the balance mode.

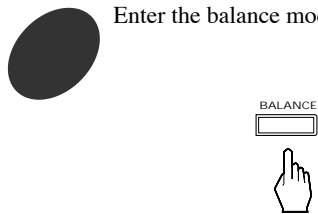

- “BAL” is displayed for 5 seconds.

Adjust the sound volume balance between the left and right speakers.

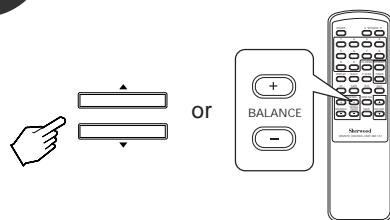

- If the balance display disappears, start from the step 11 again.
- When the BALANCE + / - buttons on the remote control are pressed, it enters the balance mode automatically without pressing the BALANCE button on the front panel.

■Note:

- In general, the balance level is set to the center position(red dot).

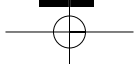

LISTENING TO RADIO

Auto tuning

1 Select the tuner and then the desired band.

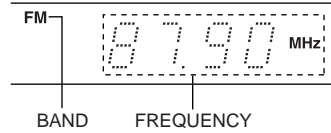
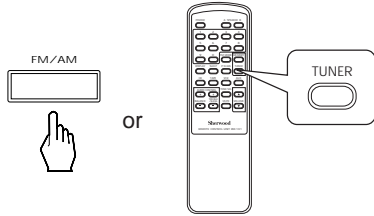

- Each time this button is pressed, the band is changed to FM or AM.

2 Select the tuning mode.



- Each time this button is pressed, the mode changes as follows:

↳ Tuning mode : “CH” goes off.
 ↳ Preset mode : “CH” lights up. ↳

3 Press the TUNING/PRESET UP(▲) or DOWN(▼) button for more than 0.5 second.

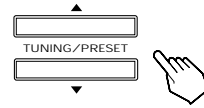

- Then “AUTO” appears on the display. The tuner will now search until a station of sufficient strength has been found. The display shows the tuned frequency and “TUNED”.
- If the station found is not the desired one, simply repeat this operation.
- Weak stations are skipped during auto tuning.

Manual tuning

- Manual tuning is useful when you already know the frequency of the desired station.
- Perform the steps 1 and 2 in “Auto tuning” procedure and press the TUNING/PRESET UP(▲) or DOWN(▼) button repeatedly until the right frequency has been reached.

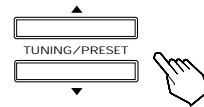

Presetting radio stations

- You can store up to 30 preferred stations in the memory.

1 Tune in the desired station with auto or manual tuning.

2 Press the MEMORY button.

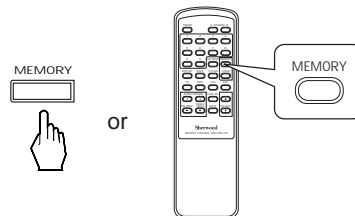

- “MEMO” is flickering for 5 seconds.

3 Select the desired preset number (1~30) and press the MEMORY button.

- When using the NUMERIC buttons on the remote control.
Examples) For “3” :
For “15” : → within 2 seconds →
For “30” :
- The station has now been stored in the memory.
- When using the NUMERIC buttons, the station is stored automatically without pressing the MEMORY button.
- A stored frequency is erased from the memory by storing another frequency in its place.
- If “MEMO” goes off, start again from the above step 2.

4 Repeat the above steps 1 to 3 to memorize other stations.

MEMORY BACKUP FUNCTION

- The following items, set before the receiver is turned off, are memorized.
- INPUT SELECTOR settings
 - Preset stations, etc.
- Note**
- If the electricity fails or the AC input cord is disconnected for more than 2 weeks, they are all cleared. So you should memorize them again.

Tuning to preset stations

1 After selecting the tuner as an input source, select the preset mode.



- Then “CH” lights up.

2 Select the desired preset number.

- When using the NUMERIC buttons on the remote control.
Examples) For “3” :
For “15” : → within 2 seconds →
For “30” :
- When selecting the desired preset number with the NUMERIC buttons, the desired preset station will be tuned to automatically without selecting the preset mode.

Listening to FM stereo broadcasts

- While listening to FM broadcasts.
-
- Each time this button is pressed, the FM mode changes as follows:
 - ↳ Stereo mode : “STEREO” lights up. ↳
 - ↳ Mono mode : “STEREO” goes off. ↳
 - When FM stereo broadcasts are poor because of weak broadcast signals, select the FM mono mode to reduce the noise, then FM broadcasts are reproduced in monaural sound.

Scanning preset stations in sequence

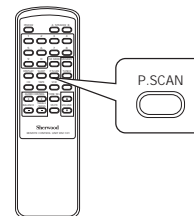

- The receiver will start scanning the stations in the preset sequence and each station is received for 5 seconds.
- At the desired station, press this button again to stop scanning.

RECORDING

- The volume, tone(bass, treble) and balance settings have no effect on the recording signals.
- When you select tuner, CD or AUX as a recording source, recording may be made on TAPE or VCR, or both simultaneously.

Recording with TAPE

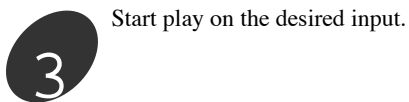
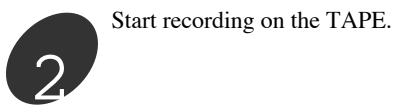
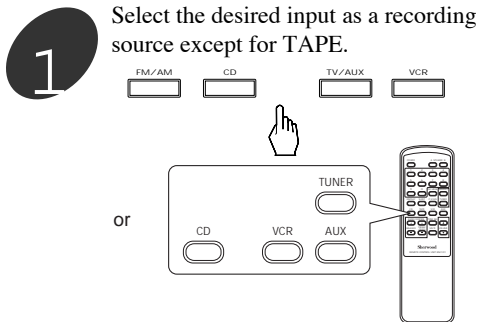

Recording with VCR

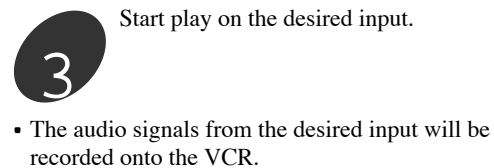
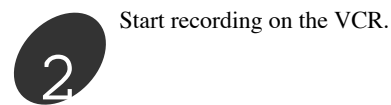
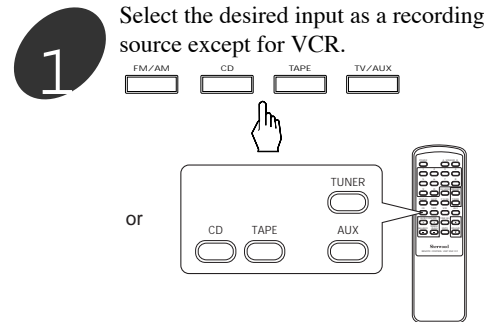

OTHER FUNCTIONS

Operating the sleep timer

- The sleep timer allows the receiver to continue to operate for a specified period of time before automatically shutting off.
- To set the receiver to automatically turn off after the specified period of time.

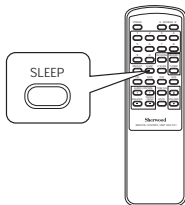

- Each time this button is pressed, the sleep time changes as follows:

→ 10 → 20 → 30 → 60 → 90 → OFF
Unit : minutes

- While operating the sleep timer, "SLEEP" lights up and the unit's fluorescent display is dimly lit.

Adjusting the brightness of the unit's fluorescent display

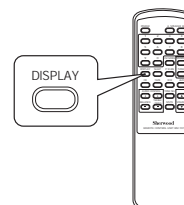

- Each time this button is pressed, the brightness of the unit's fluorescent display changes as follows:
→ ON → dim → OFF
- In the display OFF mode, pressing any button will restore the display ON mode.

Troubleshooting Guide

If a fault occurs, run through the table below before taking your receiver for repair.

If the fault persists, attempt to solve it by switching the receiver off and on again. If this fails to resolve the situation, consult your dealer. Under no circumstances should you repair the receiver yourself as this could invalidate the warranty.

PROBLEM	POSSIBLE CAUSE	REMEDY
No power	<ul style="list-style-type: none"> The AC input cord is disconnected. Poor connection at AC wall outlet or the outlet is inactive. 	<ul style="list-style-type: none"> Connect the cord securely. Check the outlet using a lamp or another appliance.
No sound	<ul style="list-style-type: none"> The speaker cords are disconnected. The volume is adjusted too low. The MUTE button on the remote control is pressed to ON. Speakers are not switched on. Incorrect selection of the input source. Incorrect connections between the components. 	<ul style="list-style-type: none"> Check the speaker connections. Adjust the volume. Press the MUTE button to cancel the muting effect. Press the SPEAKER A or B button to ON. Select the desired input source correctly. Make connections correctly.
Stations cannot be received	<ul style="list-style-type: none"> No antenna is connected. The desired station frequency is not tuned in. The antenna is in wrong position. 	<ul style="list-style-type: none"> Connect an antenna. Tune in the desired station frequency. Move the antenna and retry tuning.
Preset stations cannot be received	<ul style="list-style-type: none"> An incorrect station frequency has been memorized. The memorized stations are cleared. 	<ul style="list-style-type: none"> Memorize the correct station frequency. Memorize the stations again.
Poor FM reception	<ul style="list-style-type: none"> No antenna is connected. The antenna is not positioned for the best reception. 	<ul style="list-style-type: none"> Connect an antenna. Change the position of the antenna.
Continuous hissing noise during FM reception, especially when a stereo broadcast is received.	<ul style="list-style-type: none"> Weak signals. 	<ul style="list-style-type: none"> Change the position of the antenna. Install an outdoor antenna.
Continuous or intermittent hissing noise during AM reception, especially at night.	<ul style="list-style-type: none"> Noise is caused by motors, fluorescent lamps or lightning, etc. 	<ul style="list-style-type: none"> Keep the receiver away from noise sources. Install an outdoor AM antenna.
No recording	<ul style="list-style-type: none"> Incorrect selection between the components. Incorrect operation of each component for playback and recording. 	<ul style="list-style-type: none"> Make connections correctly. Operate each component correctly.
Remote control unit does not operate.	<ul style="list-style-type: none"> Batteries are not loaded or exhausted. The remote sensor is obstructed. 	<ul style="list-style-type: none"> Replace the batteries. Remove the obstacle.

Specifications

ENGLISH

■ AMPLIFIER SECTION

- Power output, stereo mode, 8 Ω, THD 0.9 %, 50 Hz~20 kHz 2 × 105 W
- Total harmonic distortion, 8 Ω, 105 W, 1 kHz 0.05 %
- Intermodulation distortion
60 Hz : 7 kHz= 4 : 1 SMPTE, 8 Ω, 105 W 0.3 %
- Input sensitivity, 47 kΩ
Line 200 mV
- Signal to noise ratio, IHF "A" weighted
Line 95 dB
- Frequency response
Line, 20 Hz~40 kHz ±3 dB
- Output level
TAPE/VCR OUT, 2.2 kΩ 200 mV
- Bass/Treble control, 100 Hz/10 kHz ±10 dB

■ FM TUNER SECTION

- Tuning frequency range 87.5~108 MHz
- Usable sensitivity, THD 3%, S/N 30 dB 17.2 dBf
- 50 dB quieting sensitivity, mono/stereo 20.8/41.2 dBf
- Signal to noise ratio, 65 dBf, mono/stereo 68/68 dB
- Total harmonic distortion, 65 dBf, 1 kHz, mono/stereo 0.5/0.8%
- Frequency response, 40 Hz~12 kHz ±3 dB
- Stereo separation, 1 kHz 32 dB
- Capture ratio 4 dB
- IF rejection ratio 75 dB

■ AM TUNER SECTION

- Tuning frequency range 520~1710 kHz
- Usable sensitivity 800 μV/m
- Signal to noise ratio 40 dB
- Selectivity 25 dB

■ GENERAL

- Power supply AC 120 V, 60 Hz
- Power consumption 2.5 A
- Dimensions (W × H × D) 440 × 138 × 332 mm(17-3/8 × 5-7/16 × 13 inches)
- Weight (Net) 9.5 kg(20.9 lbs)

Note: Design and specifications are subject to change without notice for improvements.

O P E R A T I N G I N S T R U C T I O N S



RX-4100
AM/FM STEREO RECEIVER

5707-21054-003-0