

**Miniature Power PCB RYII & RYII Reflow Solderable**

- 1 pole 8A, 1 form C (CO) or 1 form A (NO) or 1 form B (NC) contact
- Low component height 12.3mm
- 5kV/8mm coil-contact
- Reinforced insulation (protection class II)
- Pinnings: 3.2mm and 5mm
- Reflow-solderable version
- Especially suitable for resistive and inductive loads on form A (NO) and form B (NC) contacts
- Plastic materials according to IEC 60335-1 (domestic appliances)

Typical applications  
heating control, interface technology, domestic appliances, timers, temperature control

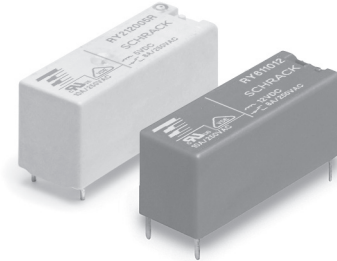

F0142-E



**Approvals**

VDE Cert. No. 40009639, UL E214025  
Technical data of approved types on request

**Contact Data**

|   |   |
|---|---|
| Contact arrangement                       | 1 form C (CO) or<br>1 form A (NO) or<br>1 form B (NC) |
| Rated voltage                             | 250VAC  |
| Max. switching voltage                    | 400VAC  |
| Rated current                             | 8A  |
| Breaking capacity max.                    | 2000VA  |
| Contact material                          | AgNi0.15, AgSnO <sub>2</sub>                          |
| Frequency of operation, with/without load | 6/1200min <sup>-1</sup>                               |
| Operate/release time max.                 | 9/5ms   |
| Bounce time max., form A/form B           | 6/10ms  |

**Contact ratings**

| Type                          | Contact     | Load                               | Cycles              |
|-------------------------------|-------------|------------------------------------|---------------------|
| <b>IEC61810</b>               |             |                                    |                     |
| RY531                         | A (NO)      | 8A, 250VAC, 70°C                   | 100x10 <sup>3</sup> |
| RY211                         | A (NO)      | 8A, 250VAC, 70°C                   | 75x10 <sup>3</sup>  |
| RY211                         | B (NC)      | 8A, 250VAC, 70°C                   | 50x10 <sup>3</sup>  |
| <b>UL508</b>                  |             |                                    |                     |
| RY211                         | A/B (NO/NC) | 10A, 250VAC, general purpose, 70°C | 30x10 <sup>3</sup>  |
| RY211                         | A (NO)      | 1/2hp, 240VAC, 85°C                | 30x10 <sup>3</sup>  |
| RY211                         | A/B (NO/NC) | B300, 70°C                         | 6x10 <sup>3</sup>   |
| <b>EN60730-1</b>              |             |                                    |                     |
| RY211                         | A/B (NO/NC) | 6(4)A, 250VAC, 85°C                | 100x10 <sup>3</sup> |
| RY211                         | A (NO)      | 8(4)A, 250VAC, 75°C                | 100x10 <sup>3</sup> |
| Mechanical endurance, DC coil |             | 30x10 <sup>6</sup> operations      |                     |

**Coil Data**

|                            |            |
|----------------------------|------------|
| Coil voltage range         | 5 to 60VDC |
| Operative range, IEC 61810 | 2          |

**Coil versions, DC coil**

| Coil code | Rated voltage VDC | Operate voltage VDC | Release voltage VDC | Coil resistance Ω±10% | Rated power mW |
|-----------|-------------------|---------------------|---------------------|-----------------------|----------------|
| 005       | 5                 | 3.5                 | 0.5                 | 112                   | 223            |
| 006       | 6                 | 4.2                 | 0.6                 | 162                   | 222            |
| 009       | 9                 | 6.3                 | 0.9                 | 320                   | 253            |
| 012       | 12                | 8.4                 | 1.2                 | 627                   | 230            |
| 024       | 24                | 16.8                | 2.4                 | 2350                  | 245            |
| 048       | 48                | 33.6                | 4.8                 | 9391                  | 245            |
| 060       | 60                | 42.0                | 6.0                 | 14000                 | 257            |

All figures are given for coil without pre-energization, at ambient temperature +23°C  
Other coil voltages on request

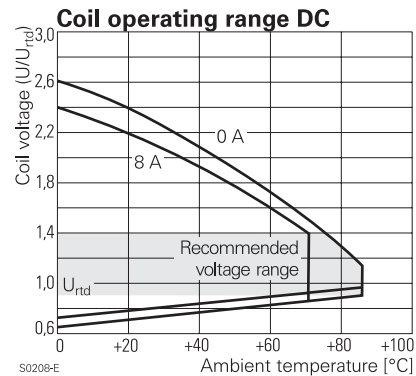
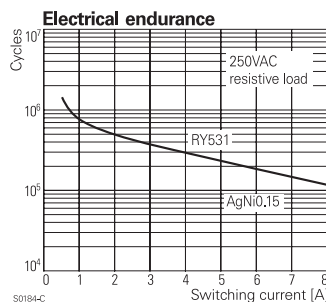
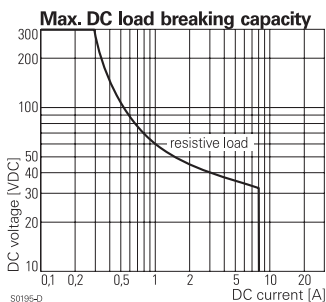

**Insulation Data**

|                                    |                      |
|------------------------------------|----------------------|
| Initial dielectric strength        |                      |
| between open contacts              | 1000V <sub>rms</sub> |
| between contact and coil           | 5000V <sub>rms</sub> |
| Clearance/creepage                 |                      |
| between contact and coil           | ≥8/8mm               |
| Material group of insulation parts | IIIa                 |
| Tracking index of relay base       | PTI250               |
| reflow-solderable version          | PTI175               |

**Miniature Power PCB RYII & RYII Reflow Solderable** (Continued)

**Other Data**

Material compliance: EU RoHS/ELV, China RoHS, REACH, Halogen content refer to the Product Compliance Support Center at [www.te.com/customersupport/rohssupportcenter](http://www.te.com/customersupport/rohssupportcenter)

|   |   |
|---|---|
| Ambient temperature   | -40 to +70°C<br>+85°C at 6A                           |
| Category of environmental protection<br>IEC 61810             | RTII - flux proof<br>RTIII - wash tight <sup>1)</sup> |
| Vibration resistance (functional),<br>form A (NO)/form B (NC) | 20/5g   |
| Shock resistance (functional)<br>form A (NO)/form B (NC)      | 20/5g   |
| Shock resistance (destructive)                                | 100g  |
| Terminal type   | PCB-THT, PCB-THR                                      |
| Weight  | 8g  |
| Resistance to soldering heat THT<br>IEC 60068-2-20            | RTII : 270°C/10s<br>RTIII : 260°C/5s                  |
| Resistance to soldering heat THR<br>IEC 60068-2-58            | 250°C, no infrared heating allowed                    |
| Packaging/unit<br>standard version                            | tube/20 pcs., box/500 pcs.                            |
| reflow version  | reel/280 pcs.<br>box/1120 pcs. (4 reels)              |

<sup>1)</sup> not available as reflow-solderable version

**Accessories**

For details see datasheet [Accessories Miniature PCB Relay RY](#)

**PCB layout / terminal assignment**

Bottom view on solder pins

1 form C (CO) contact, 3.2mm

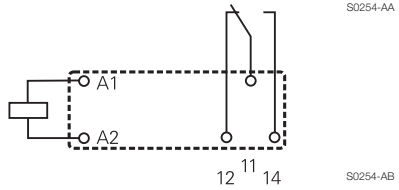
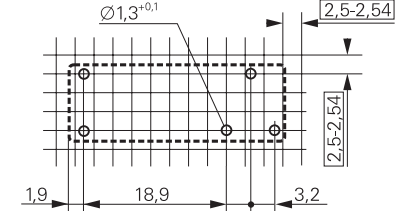

1 form A (NO), 1 form B (NC) contact 5mm

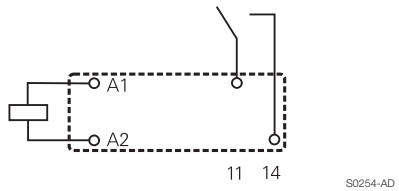
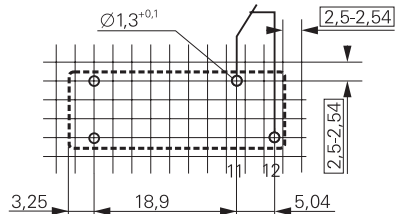
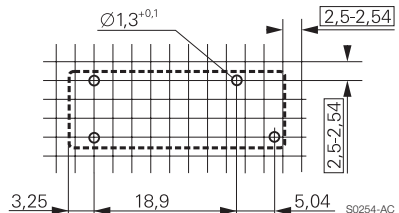

**Dimensions**

Pinning 3.2mm

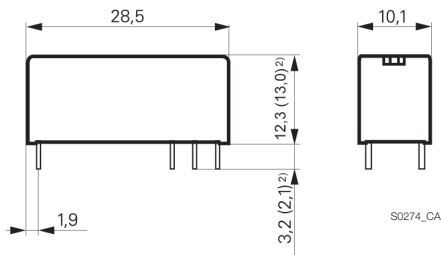

Pinning 5mm

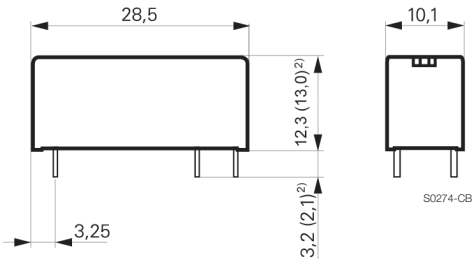

<sup>2)</sup> Values in brackets are valid for reflow-solderable version

**Miniature Power PCB RYII & RYII Reflow Solderable** (Continued)

**Soldering profile for reflow-solderable version**

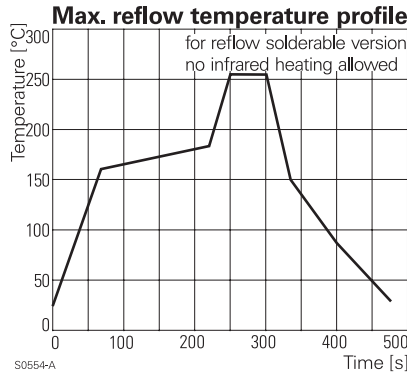

**Tape dimensions**

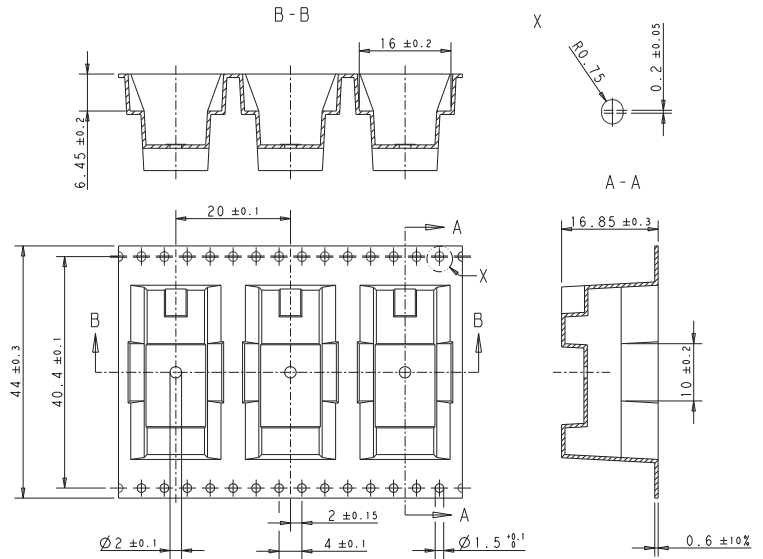

**Reel dimensions**

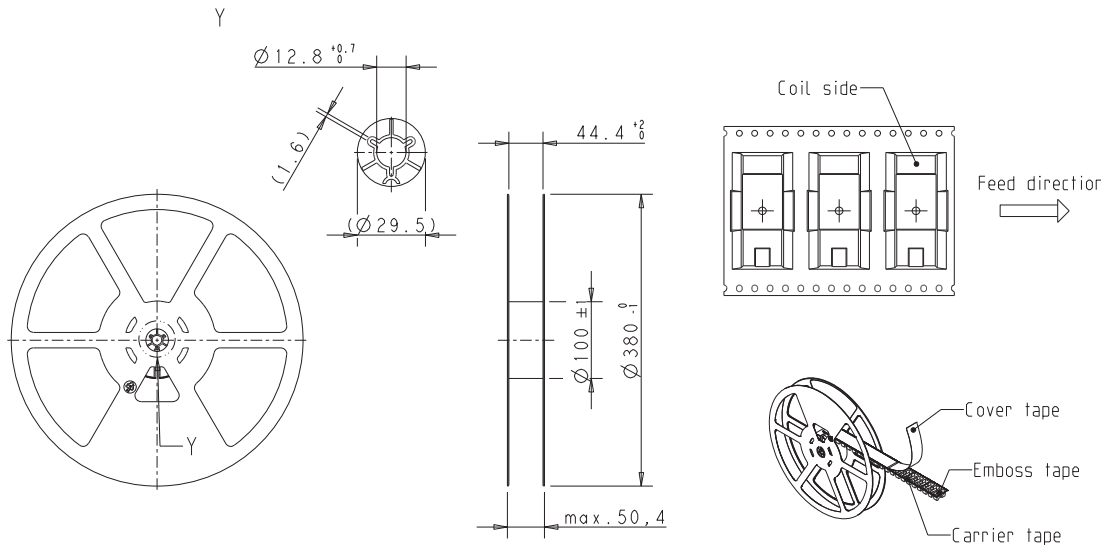

**Product code structure**

Typical product code **RY 6 1 1 012**

**Type**

**RY** Miniature Power PCB RYII & RYII reflow solderable

**Version**

- 2** pinning 3.2mm, flux proof
- 5** pinning 5mm, flux proof
- 6** pinning 3.2mm, wash tight <sup>2)</sup>
- A** pinning 5mm, wash tight <sup>2)</sup>

**Contact arrangement**

- 1** 1 form C (1 CO), pinning 3.2mm
- 3** 1 form A (1 NO), pinning 5mm
- 5** 1 form B (1 NC), pinning 5mm

**Contact material**

- 1** AgNi 0.15
- 3** AgSnO<sub>2</sub>
- 2** AgNi 0.15 gold plated

**Coil**

Coil code: please refer to coil versions table

**Version**

- Blank** Standard version
- R** reflow-solderable

<sup>2)</sup> not available as reflow-solderable version

**Miniature Power PCB RYII & RYII Reflow Solderable** (Continued)

| Product code | Version                      | Contacts                  | Contact material         | Coil      | Part number |
|--------------|------------------------------|---------------------------|--------------------------|-----------|-------------|
| RY211005     | Pinning 3.2 mm<br>flux proof | 1 form C,<br>1 CO contact | AgNi 0.15                | 5VDC      | 4-1393224-2 |
| RY211012     |                              |                           |                          | 12VDC     | 4-1393224-6 |
| RY211024     |                              |                           |                          | 24VDC     | 4-1393224-9 |
| RY211048     |                              |                           |                          | 48VDC     | 5-1393224-1 |
| RY212005     |                              |                           | AgNi 0.15<br>gold plated | 5VDC      | 5-1393224-2 |
| RY212012     |                              |                           |                          | 12VDC     | 5-1393224-5 |
| RY212024     |                              |                           |                          | 24VDC     | 5-1393224-8 |
| RY212048     |                              |                           |                          | 48VDC     | 5-1393224-9 |
| RY213005     |                              |                           | AgSnO <sub>2</sub>       | 5VDC      | 6-1393224-0 |
| RY213012     |                              |                           |                          | 12VDC     | 6-1393224-1 |
| RY213024     |                              |                           |                          | 24VDC     | 6-1393224-2 |
| RY213048     |                              |                           |                          | 48VDC     | 6-1393224-3 |
| RY531005     | Pinning 5 mm<br>flux proof   | 1 form A,<br>1 NO contact | AgNi 0.15                | 5VDC      | 7-1393224-6 |
| RY531012     |                              |                           |                          | 12VDC     | 7-1393224-9 |
| RY531024     |                              |                           |                          | 24VDC     | 8-1393224-2 |
| RY531048     |                              |                           |                          | 48VDC     | 8-1393224-3 |
| RY532012     |                              |                           | AgNi 0.15<br>gold plated | 12VDC     | 8-1393224-4 |
| RY532024     |                              |                           |                          | 24VDC     | 8-1393224-5 |
| RY533012     |                              |                           | AgSnO <sub>2</sub>       | 12VDC     | 8-1393224-8 |
| RY533024     |                              |                           |                          | 24VDC     | 8-1393224-9 |
| RY533048     |                              |                           |                          | 48VDC     | 9-1393224-0 |
| RY611005     | Pinning 3.2 mm<br>wash tight | 1 form C,<br>1 CO contact | AgNi 0.15                | 5VDC      | 1-1393225-7 |
| RY611012     |                              |                           |                          | 12VDC     | 1-1393225-9 |
| RY611024     |                              |                           |                          | 24VDC     | 2-1393225-1 |
| RY611048     |                              |                           |                          | 48VDC     | 2-1393225-2 |
| RY612005     |                              |                           | AgNi 0.15<br>gold plated | 5VDC      | 2-1393225-3 |
| RY612012     |                              |                           |                          | 12VDC     | 2-1393225-6 |
| RY612024     |                              |                           |                          | 24VDC     | 2-1393225-9 |
| RY612048     |                              |                           |                          | 48VDC     | 3-1393225-0 |
| RY613005     |                              |                           | AgSnO <sub>2</sub>       | 5VDC      | 5-1419136-2 |
| RY613012     |                              |                           |                          | 12VDC     | 3-1393225-1 |
| RY613024     |                              |                           |                          | 24VDC     | 3-1393225-3 |
| RY613048     |                              |                           |                          | 48VDC     | 3-1393225-4 |
| RY631024     |                              | 1 form A,                 | AgNi 0.15                | 24VDC     | 4-1415400-1 |
| RYA31005     | Pinning 5 mm<br>wash tight   | 1 NO contact              |                          | 5VDC      | 1393224-7   |
| RYA31012     |                              |                           | 12VDC                    | 1393224-9 |             |
| RYA31024     |                              |                           |                          | 24VDC     | 1-1393224-2 |
| RYA31048     |                              |                           |                          | 48VDC     | 1-1393224-3 |
| RYA32005     |                              |                           | AgNi 0.15<br>gold plated | 5VDC      | 1-1393224-4 |
| RYA32012     |                              |                           |                          | 12VDC     | 1-1393224-6 |
| RYA32024     |                              |                           |                          | 24VDC     | 1-1393224-8 |
| RYA33005     |                              |                           | AgSnO <sub>2</sub>       | 5VDC      | 1-1393224-9 |
| RYA33024     |                              |                           |                          | 24VDC     | 2-1393224-1 |

| Product code | Version  | Contacts                  | Contact material | Coil  | Part number |
|--------------|--|---------------------------|------------------|-------|-------------|
| RY211005R    | pinning 3.2mm<br>flux proof<br>reflow solderable | 1 form C,<br>1 CO contact | AgNi 0.15        | 5VDC  | 1-1956170-2 |
| RY211012R    |  |                           |                  | 12VDC | 1-1956170-6 |
| RY211024R    |  |                           |                  | 24VDC | 1956164-1   |
| RY531005R    | pinning 5.0mm<br>flux proof<br>reflow solderable | 1 form A,<br>1 NO contact |                  | 5VDC  | 1-1956171-1 |
| RY531012R    |  |                           |                  | 12VDC | 1-1956171-4 |
| RY531024R    |  |                           |                  | 24VDC | 1-1956171-7 |