

**S-802/812 Series****VOLTAGE REGULATOR**

The S-802/812 Series are three-terminal voltage regulators that use a CMOS process. The output voltage is fixed internally: the S-802 Series outputs negative voltage, and the S-812 Series outputs positive voltage. Since the S-802/812 Series consume less current and need a smaller input/output voltage difference than existing three-terminal voltage regulators, battery-powered portable equipment can have a higher capacitance and a longer service life.

### ■ Features

- Low power consumption
- Small input/output voltage difference  
(S-81250HG: 30 mV typ.  $I_{OUT} = 1$  mA)
- Low temperature coefficient of output voltage  
(S-81230AG:  $\pm 0.375$  mV/°C typ.)
- Wide operating voltage range  
(S-81250HG: 12 V max.)
- Good input stability: 0.1%/V typ.
- TO-92 and SOT-89 mini-powermold plastic packages are available

### ■ Applications

- Constant voltage power supply of battery-powered equipment, communications equipment, video equipment and others

### ■ Selection Guide

Table 1

Output voltage	TO-92	Mini-powermold*
-3 V $\pm$ 5%	S-80230AG	S-80230AG-GA-X
-5 V $\pm$ 5%	S-80250AG	S-80250AG-GB-X
1.5 V $\pm$ 5%	S-81215AG	S-81215AG-RK-X
2.5 V $\pm$ 5%	—	S-81225AG-RH-X
3.0 V $\pm$ 5%	S-81230AG	S-81230AG-RB-X
3.5 V $\pm$ 5%	—	S-81235AG-RI-X
3.7 V $\pm$ 5%	S-81237AG	S-81237AG-RE-X
4.0 V $\pm$ 5%	—	S-81240AG-RJ-X
5.0 V $\pm$ 5%	S-81250HG	S-81250HG-RD-X
5.2 V $\pm$ 5%	S-81252HG	S-81252HG-RL-X

\* The last digit of the model name changes according to the packing form when it is a mini-powermold plastic package product.

X = S : Stick

X = T1 or T2 : Tape

# S-802/812 Series

## Block Diagram

### 1. S-802 Series

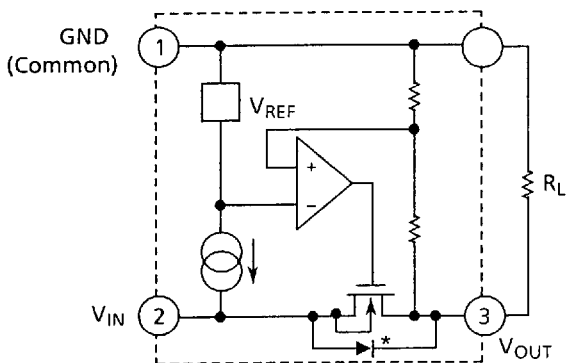

Figure 1 (In case of TO-92)

### 2. S-812 Series

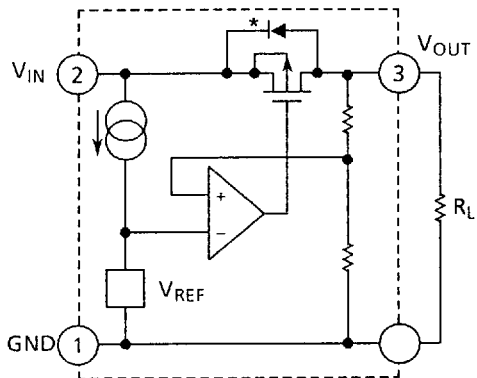
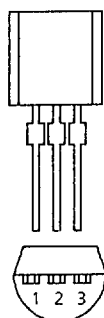

Figure 2 \* Parasitic diode

## Pin Arrangement

### 1. TO-92



No.	S-802	S-812
1	GND	GND
2	V <sub>IN</sub>	V <sub>IN</sub>
3	V <sub>OUT</sub>	V <sub>OUT</sub>

Bottom view

Figure 3

### 2. Mini-powermold

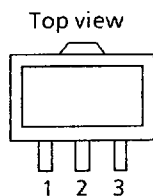

No.	S-802	S-812
1	V <sub>OUT</sub>	GND
2	GND	V <sub>IN</sub>
3	V <sub>IN</sub>	V <sub>OUT</sub>

Figure 4

## Absolute Maximum Ratings

Table 2

(Unless otherwise specified: T<sub>a</sub> = 25°C)

Item		Symbol	Ratings	Unit
Input voltage	S-802 Series	V <sub>IN</sub>	-12	V
	S-812 Series		12	
	S-81250HG/52HG		18	
Output voltage	S-802 Series	V <sub>OUT</sub>	V <sub>IN</sub> -0.3 to V <sub>SS</sub> + 0.3	V
	S-812 Series		V <sub>IN</sub> + 0.3 to V <sub>SS</sub> -0.3	
Output current		I <sub>OUT</sub>	100	mA
Power dissipation		P <sub>D</sub>	200	mW
Operating temperature		T <sub>opr</sub>	-20 to +70	°C
Storage temperature		T <sub>stg</sub>	-40 to +125	

Caution: Keep static electricity to a minimum.

## ■ Electrical Characteristics

### 1. S-802 Series

#### 1.1 S-80230AG, S-80230AG-GA-X (-3 V output type)

**Table 3**

(Unless otherwise specified: Ta = 25°C)

Item	Symbol	Conditions	Min.	Typ.	Max.	Unit	Test circuit
Output voltage	$V_{OUT}$	$V_{IN} = -5 V, I_{OUT} = 10 mA$	-3.15	-3.00	-2.85	V	1
Output current	$I_{OUT}$	$V_{IN} = -5 V$	20	30	—	mA	1
Load regulation	$\Delta V_{OUT}$	$1 mA \leq I_{OUT} \leq 20 mA$ $V_{IN} = -5 V$	—	60	100	mV	1
I/O voltage difference	$V_{dif}$	$I_{OUT} = 1 mA$	—	60	—	mV	—
Current consumption	$I_{SS}$	$V_{IN} = -5 V, \text{No load}$	—	2.5	6.0	$\mu A$	2
Line regulation	$\frac{\Delta V_{OUT}}{\Delta V_{IN} \cdot V_{OUT}}$	$-10 V \leq V_{IN} \leq -4 V$ $I_{OUT} = 1 mA$	—	0.1	—	%/V	1
Input voltage	$V_{IN}$		-10	—	—	V	—
Temperature characteristic of $\Delta V_{OUT}$	$\frac{\Delta V_{OUT}}{\Delta Ta}$	$V_{IN} = -5 V, I_{OUT} = 10 mA$ $-20^\circ C \leq Ta \leq 70^\circ C$	—	$\pm 0.375$	—	mV/°C	—

#### 1.2 S-80250AG, S-80250AG-GB-X (-5 V output type)

**Table 4**

(Unless otherwise specified: Ta = 25°C)

Item	Symbol	Conditions	Min.	Typ.	Max.	Unit	Test circuit
Output voltage	$V_{OUT}$	$V_{IN} = -7 V, I_{OUT} = 10 mA$	-5.25	-5.00	-4.75	V	1
Output current	$I_{OUT}$	$V_{IN} = -7 V$	40	50	—	mA	1
Load regulation	$\Delta V_{OUT}$	$1 mA \leq I_{OUT} \leq 40 mA$ $V_{IN} = -7 V$	—	40	80	mV	1
I/O voltage difference	$V_{dif}$	$I_{OUT} = 1 mA$	—	30	—	mV	—
Current consumption	$I_{SS}$	$V_{IN} = -7 V, \text{No load}$	—	3.0	7.0	$\mu A$	2
Line regulation	$\frac{\Delta V_{OUT}}{\Delta V_{IN} \cdot V_{OUT}}$	$-10 V \leq V_{IN} \leq -6 V$ $I_{OUT} = 1 mA$	—	0.1	—	%/V	1
Input voltage	$V_{IN}$		-10	—	—	V	—
Temperature characteristic of $\Delta V_{OUT}$	$\frac{\Delta V_{OUT}}{\Delta Ta}$	$V_{IN} = -7 V, I_{OUT} = 10 mA$ $-20^\circ C \leq Ta \leq 70^\circ C$	—	$\pm 0.625$	—	mV/°C	—

# S-802/812 Series

## 2. S-812 Series

### 2.1 S-81215AG, S-81215AG-RK-X (+ 1.5 V output type)

**Table 5**

(Unless otherwise specified:  $T_a = 25^\circ\text{C}$ )

Item	Symbol	Conditions	Min.	Typ.	Max.	Unit	Test circuit
Output voltage	$V_{\text{OUT}}$	$V_{\text{IN}} = 3.5 \text{ V}, I_{\text{OUT}} = 0.5 \text{ mA}$	1.425	1.50	1.575	V	3
Output current	$I_{\text{OUT}}$	$V_{\text{IN}} = 3.5 \text{ V}$	7.0	—	—	mA	3
Load regulation	$\Delta V_{\text{OUT}}$	$1 \text{ mA} \leq I_{\text{OUT}} \leq 7 \text{ mA}$ $V_{\text{IN}} = 3.5 \text{ V}$	—	80	—	mV	3
I/O voltage difference	$V_{\text{dif}}$	$I_{\text{OUT}} = 0.5 \text{ mA}$	—	300	—	mV	—
Current consumption	$I_{\text{SS}}$	$V_{\text{IN}} = 3.5 \text{ V}, \text{ No load}$	—	2.2	5.0	$\mu\text{A}$	4
Line regulation	$\frac{\Delta V_{\text{OUT}}}{\Delta V_{\text{IN}} \cdot V_{\text{OUT}}}$	$2.5 \text{ V} \leq V_{\text{IN}} \leq 10 \text{ V}$ $I_{\text{OUT}} = 0.5 \text{ mA}$	—	0.1	—	%/V	3
Input voltage	$V_{\text{IN}}$		—	—	10	V	—
Temperature characteristic of $\Delta V_{\text{OUT}}$	$\frac{\Delta V_{\text{OUT}}}{\Delta T_a}$	$V_{\text{IN}} = 3.5 \text{ V}, I_{\text{OUT}} = 0.5 \text{ mA}$ $-20^\circ\text{C} \leq T_a \leq 70^\circ\text{C}$	—	$\pm 0.19$	—	mV/ $^\circ\text{C}$	—

### 2.2 S-81225AG-RH-X (+ 2.5 V output type)

**Table 6**

(Unless otherwise specified:  $T_a = 25^\circ\text{C}$ )

Item	Symbol	Conditions	Min.	Typ.	Max.	Unit	Test circuit
Output voltage	$V_{\text{OUT}}$	$V_{\text{IN}} = 4.5 \text{ V}, I_{\text{OUT}} = 10 \text{ mA}$	2.375	2.50	2.625	V	3
Output current	$I_{\text{OUT}}$	$V_{\text{IN}} = 4.5 \text{ V}$	10	25	—	mA	3
Load regulation	$\Delta V_{\text{OUT}}$	$1 \text{ mA} \leq I_{\text{OUT}} \leq 10 \text{ mA}$ $V_{\text{IN}} = 4.5 \text{ V}$	—	80	120	mV	3
I/O voltage difference	$V_{\text{dif}}$	$I_{\text{OUT}} = 1 \text{ mA}$	—	100	—	mV	—
Current consumption	$I_{\text{SS}}$	$V_{\text{IN}} = 4.5 \text{ V}, \text{ No load}$	—	2.5	6.0	$\mu\text{A}$	4
Line regulation	$\frac{\Delta V_{\text{OUT}}}{\Delta V_{\text{IN}} \cdot V_{\text{OUT}}}$	$3.5 \text{ V} \leq V_{\text{IN}} \leq 10 \text{ V}$ $I_{\text{OUT}} = 0.5 \text{ mA}$	—	0.1	—	%/V	3
Input voltage	$V_{\text{IN}}$		—	—	10	V	—
Temperature characteristic of $\Delta V_{\text{OUT}}$	$\frac{\Delta V_{\text{OUT}}}{\Delta T_a}$	$V_{\text{IN}} = 4.5 \text{ V}, I_{\text{OUT}} = 10 \text{ mA}$ $-20^\circ\text{C} \leq T_a \leq 70^\circ\text{C}$	—	$\pm 0.31$	—	mV/ $^\circ\text{C}$	—

## 2.3 S-81230AG, S-81230AG-RB-X (+ 3 V output type)

**Table 7**

(Unless otherwise specified: Ta = 25°C)

Item	Symbol	Conditions	Min.	Typ.	Max.	Unit	Test circuit
Output voltage	V <sub>OUT</sub>	V <sub>IN</sub> = 5 V, I <sub>OUT</sub> = 10 mA	2.85	3.00	3.15	V	3
Output current	I <sub>OUT</sub>	V <sub>IN</sub> = 5 V	20	30	—	mA	3
Load regulation	ΔV <sub>OUT</sub>	1 mA ≤ I <sub>OUT</sub> ≤ 20 mA V <sub>IN</sub> = 5 V	—	60	100	mV	3
I/O voltage difference	V <sub>dif</sub>	I <sub>OUT</sub> = 1 mA	—	60	—	mV	—
Current consumption	I <sub>SS</sub>	V <sub>IN</sub> = 5 V, No load	—	2.5	6.0	μA	4
Line regulation	$\frac{\Delta V_{OUT}}{\Delta V_{IN} \cdot V_{OUT}}$	4 V ≤ V <sub>IN</sub> ≤ 10 V I <sub>OUT</sub> = 1 mA	—	0.1	—	%/V	3
Input voltage	V <sub>IN</sub>		—	—	10	V	—
Temperature characteristic of ΔV <sub>OUT</sub>	$\frac{\Delta V_{OUT}}{\Delta T_a}$	V <sub>IN</sub> = 5 V, I <sub>OUT</sub> = 10 mA -20°C ≤ Ta ≤ 70°C	—	± 0.375	—	mV/°C	—

## 2.4 S-81235AG-RI-X (+ 3.5 V output type)

**Table 8**

(Unless otherwise specified: Ta = 25°C)

Item	Symbol	Conditions	Min.	Typ.	Max.	Unit	Test circuit
Output voltage	V <sub>OUT</sub>	V <sub>IN</sub> = 5.5 V, I <sub>OUT</sub> = 10 mA	3.325	3.50	3.675	V	3
Output current	I <sub>OUT</sub>	V <sub>IN</sub> = 5.5 V	20	30	—	mA	3
Load regulation	ΔV <sub>OUT</sub>	1 mA ≤ I <sub>OUT</sub> ≤ 30 mA V <sub>IN</sub> = 5.5 V	—	60	100	mV	3
I/O voltage difference	V <sub>dif</sub>	I <sub>OUT</sub> = 1 mA	—	60	—	mV	—
Current consumption	I <sub>SS</sub>	V <sub>IN</sub> = 5.5 V, No load	—	2.5	6.0	μA	4
Line regulation	$\frac{\Delta V_{OUT}}{\Delta V_{IN} \cdot V_{OUT}}$	4.5 V ≤ V <sub>IN</sub> ≤ 10 V I <sub>OUT</sub> = 1 mA	—	0.1	—	%/V	3
Input voltage	V <sub>IN</sub>		—	—	10	V	—
Temperature characteristic of ΔV <sub>OUT</sub>	$\frac{\Delta V_{OUT}}{\Delta T_a}$	V <sub>IN</sub> = 5.5 V, I <sub>OUT</sub> = 10 mA -20°C ≤ Ta ≤ 70°C	—	± 0.438	—	mV/°C	—

# S-802/812 Series

## 2.5 S-81237AG, S-81237AG-RE-X (+ 3.7 V output type)

**Table 9**

(Unless otherwise specified: Ta = 25°C)

Item	Symbol	Conditions	Min.	Typ.	Max.	Unit	Test circuit
Output voltage	V <sub>OUT</sub>	V <sub>IN</sub> = 5.7 V, I <sub>OUT</sub> = 10 mA	3.50	3.70	3.90	V	3
Output current	I <sub>OUT</sub>	V <sub>IN</sub> = 5.7 V	20	30	—	mA	3
Load regulation	ΔV <sub>OUT</sub>	1 mA ≤ I <sub>OUT</sub> ≤ 20 mA V <sub>IN</sub> = 5.7 V	—	60	100	mV	3
I/O voltage difference	V <sub>dif</sub>	I <sub>OUT</sub> = 1 mA	—	60	—	mV	—
Current consumption	I <sub>SS</sub>	V <sub>IN</sub> = 5.7 V, No load	—	2.0	4.0	μA	4
Line regulation	$\frac{\Delta V_{OUT}}{\Delta V_{IN} \cdot V_{OUT}}$	4.7 V ≤ V <sub>IN</sub> ≤ 10 V I <sub>OUT</sub> = 1 mA	—	0.1	—	%/V	3
Input voltage	V <sub>IN</sub>		—	—	10	V	—
Temperature characteristic of ΔV <sub>OUT</sub>	$\frac{\Delta V_{OUT}}{\Delta T_a}$	V <sub>IN</sub> = 5.7 V, I <sub>OUT</sub> = 10 mA -20°C ≤ Ta ≤ 70°C	—	± 0.46	—	mV/°C	—

## 2.6 S-81240AG-RJ-X (+ 4.0 V output type)

**Table 10**

(Unless otherwise specified: Ta = 25°C)

Item	Symbol	Conditions	Min.	Typ.	Max.	Unit	Test circuit
Output voltage	V <sub>OUT</sub>	V <sub>IN</sub> = 6 V, I <sub>OUT</sub> = 10 mA	3.80	4.0	4.20	V	3
Output current	I <sub>OUT</sub>	V <sub>IN</sub> = 6 V	30	40	—	mA	3
Load regulation	ΔV <sub>OUT</sub>	1 mA ≤ I <sub>OUT</sub> ≤ 30 mA V <sub>IN</sub> = 6 V	—	50	90	mV	3
I/O voltage difference	V <sub>dif</sub>	I <sub>OUT</sub> = 1 mA	—	50	—	mV	—
Current consumption	I <sub>SS</sub>	V <sub>IN</sub> = 6 V, No load	—	3.0	7.0	μA	4
Line regulation	$\frac{\Delta V_{OUT}}{\Delta V_{IN} \cdot V_{OUT}}$	5 V ≤ V <sub>IN</sub> ≤ 10 V I <sub>OUT</sub> = 1 mA	—	0.1	—	%/V	3
Input voltage	V <sub>IN</sub>		—	—	10	V	—
Temperature characteristic of ΔV <sub>OUT</sub>	$\frac{\Delta V_{OUT}}{\Delta T_a}$	V <sub>IN</sub> = 6 V, I <sub>OUT</sub> = 10 mA -20°C ≤ Ta ≤ 70°C	—	± 0.5	—	mV/°C	—

## 2.7 S-81250HG, S-81250HG-RD-X (+ 5.0 V output high-input voltage type)

**Table 11**

(Unless otherwise specified: Ta = 25°C)

Item	Symbol	Conditions	Min.	Typ.	Max.	Unit	Test circuit
Output voltage	V <sub>OUT</sub>	V <sub>IN</sub> = 7 V, I <sub>OUT</sub> = 10 mA	4.75	5.0	5.25	V	3
Output current	I <sub>OUT</sub>	V <sub>IN</sub> = 7 V	40	50	—	mA	3
Load regulation	ΔV <sub>OUT</sub>	1 mA ≤ I <sub>OUT</sub> ≤ 40 mA V <sub>IN</sub> = 7 V	—	40	80	mV	3
I/O voltage difference	V <sub>dif</sub>	I <sub>OUT</sub> = 1 mA	—	30	—	mV	—
Current consumption	I <sub>SS</sub>	V <sub>IN</sub> = 7 V, No load	—	3.0	7.0	μA	4
Line regulation	$\frac{\Delta V_{OUT}}{\Delta V_{IN} \cdot V_{OUT}}$	6 V ≤ V <sub>IN</sub> ≤ 10 V I <sub>OUT</sub> = 1 mA	—	0.1	—	%/V	3
Input voltage	V <sub>IN</sub>		—	—	12	V	—
Temperature characteristic of ΔV <sub>OUT</sub>	$\frac{\Delta V_{OUT}}{\Delta Ta}$	V <sub>IN</sub> = 7 V, I <sub>OUT</sub> = 10 mA -20°C ≤ Ta ≤ 70°C	—	± 0.625	—	mV/°C	—

## 2.8 S-81252HG, S-81252HG-RL-X (+ 5.2 V output high-input voltage type)

**Table 12**

(Unless otherwise specified: Ta = 25°C)

Item	Symbol	Conditions	Min.	Typ.	Max.	Unit	Test circuit
Output voltage	V <sub>OUT</sub>	V <sub>IN</sub> = 7.2 V, I <sub>OUT</sub> = 10 mA	5.00	5.20	5.40	V	3
Output current	I <sub>OUT</sub>	V <sub>IN</sub> = 7.2 V	40	50	—	mA	3
Load regulation	ΔV <sub>OUT</sub>	1 mA ≤ I <sub>OUT</sub> ≤ 40 mA V <sub>IN</sub> = 7.2 V	—	40	80	mV	3
I/O voltage difference	V <sub>dif</sub>	I <sub>OUT</sub> = 1 mA	—	30	—	mV	—
Current consumption	I <sub>SS</sub>	V <sub>IN</sub> = 7.2 V, No load	—	3.0	7.0	μA	4
Line regulation	$\frac{\Delta V_{OUT}}{\Delta V_{IN} \cdot V_{OUT}}$	6.2 V ≤ V <sub>IN</sub> ≤ 15 V I <sub>OUT</sub> = 1 mA	—	0.1	—	%/V	3
Input voltage	V <sub>IN</sub>		—	—	15	V	—
Temperature characteristic of ΔV <sub>OUT</sub>	$\frac{\Delta V_{OUT}}{\Delta Ta}$	V <sub>IN</sub> = 7.2 V, I <sub>OUT</sub> = 10 mA -20°C ≤ Ta ≤ 70°C	—	± 0.68	—	mV/°C	—

# S-802/812 Series

## Test Circuits

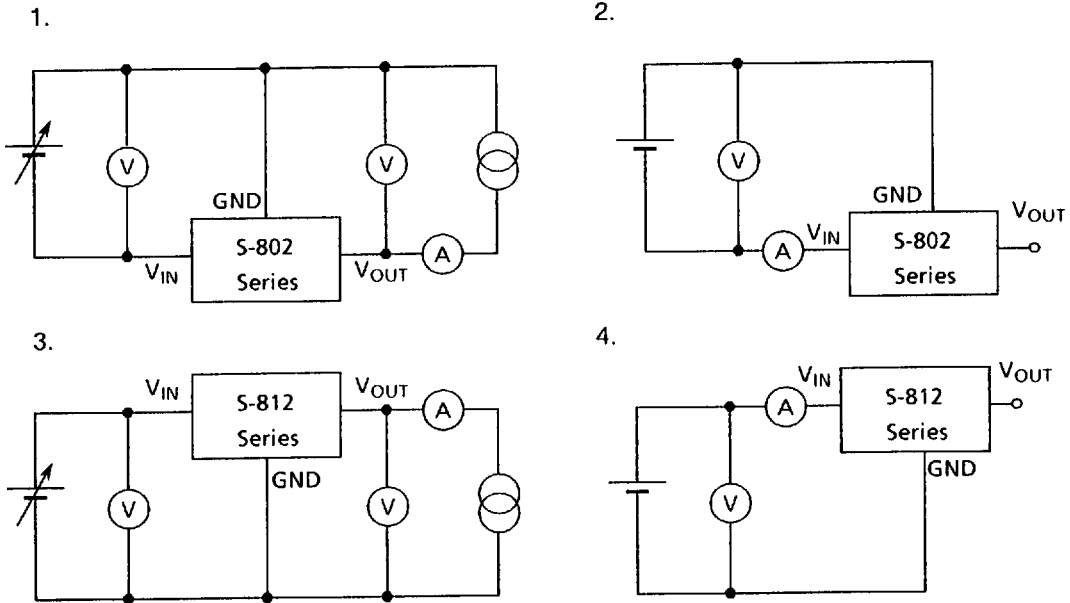
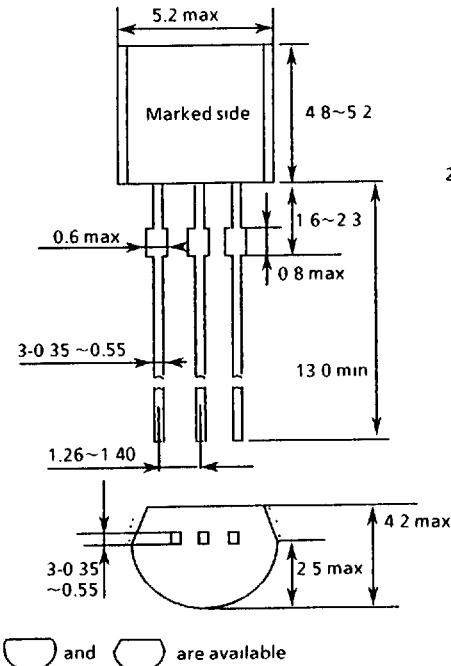

Figure 5

## Dimensions

### 1. TO-92



### 2. SOT-89 mini-powermold

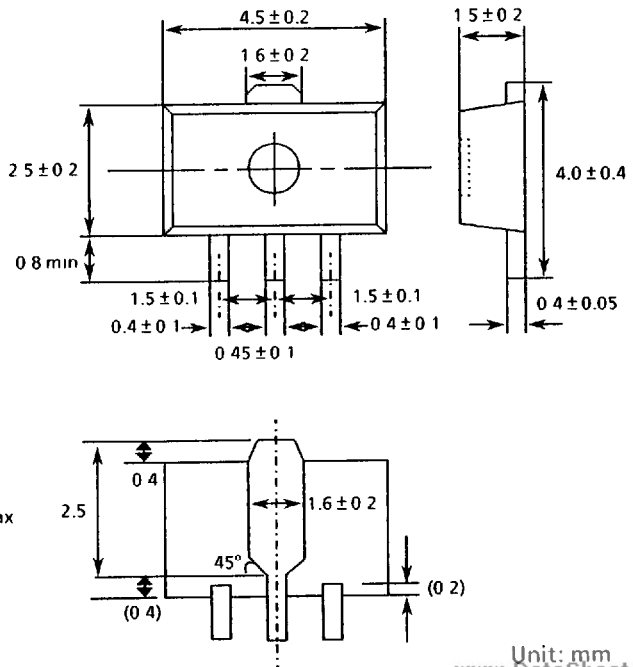

Figure 6

Unit: mm  
www.DataSheet4U.com



## ■ Taping Dimensions

### 1. Tape specifications

T1 and T2 types are available with the tape in the direction of the electrode when pulled out.

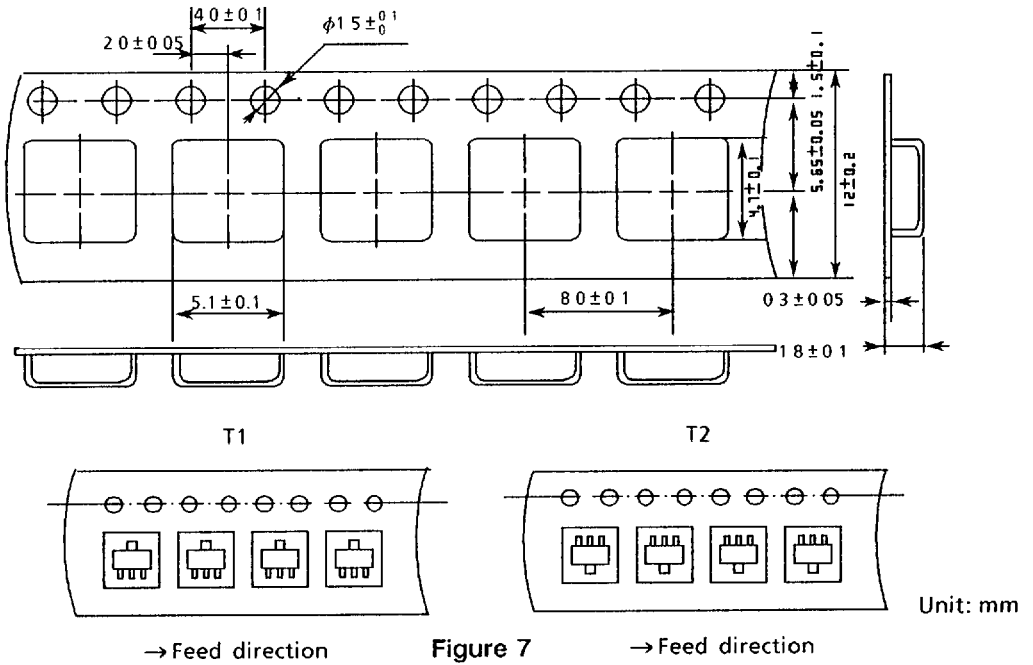

### 2. Reel specifications

1 reel has 1000 regulators.

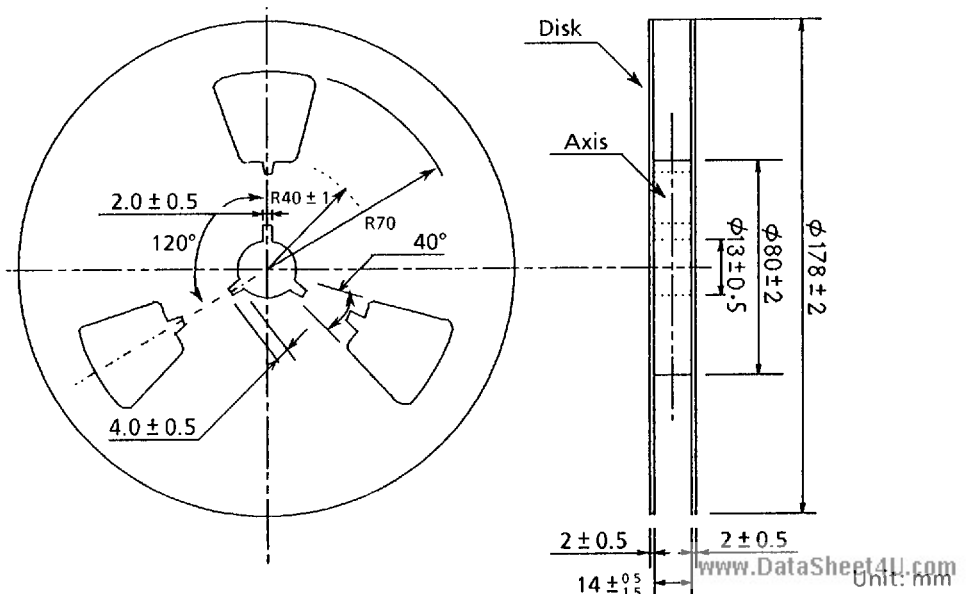

Figure 8

# S-802/812 Series

## Magazine Dimensions

1 stick has 25 regulators.

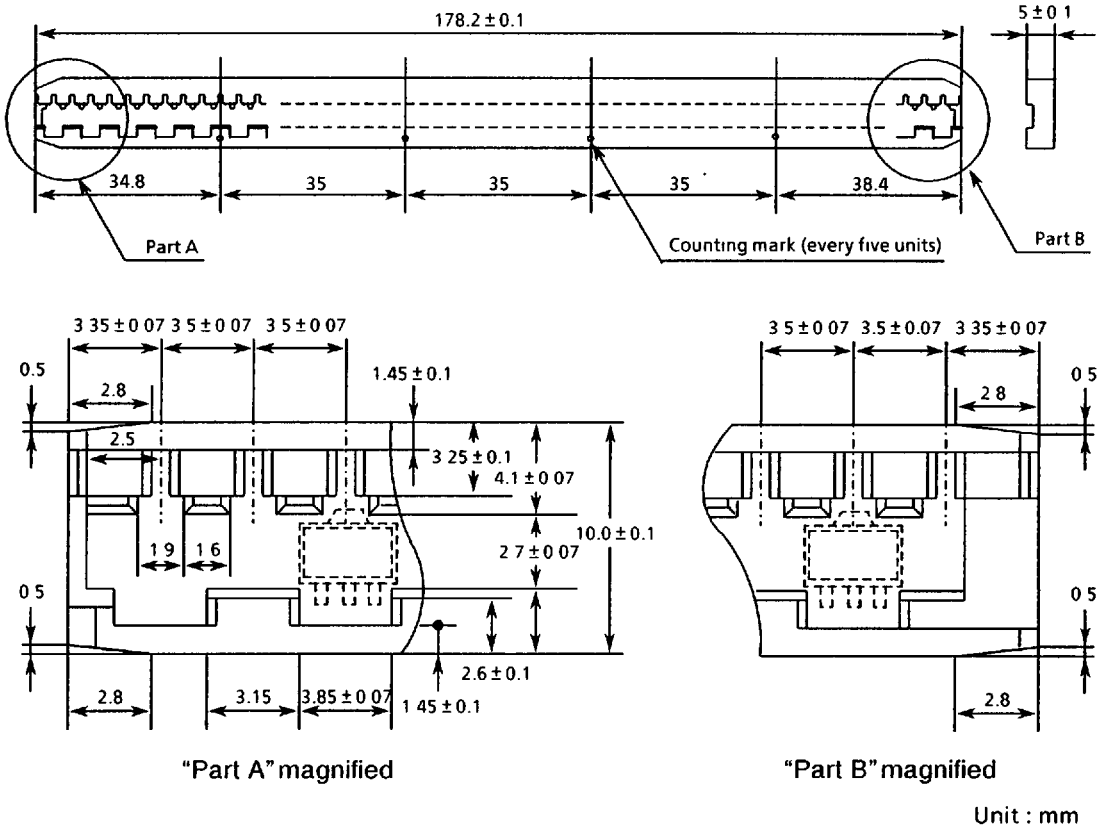
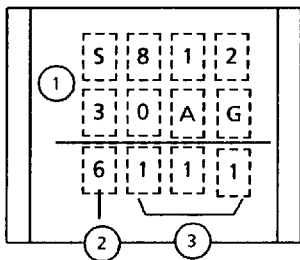

Figure 9

## Markings

1. TO-92

2. SOT-89 mini-powermold



- ① Model No.
- ② The last digit of the year
- ③ Lot No.

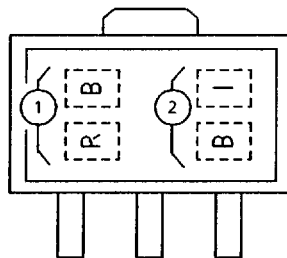

- ① Model No. (abbreviation)
- ② Lot No.

Figure 10 Marking examples

Seiko Instruments Inc.

**■ Technical Terms****1. Output voltage ( $V_{OUT}$ )**

Output voltage  $V_{OUT}$  is that voltage guaranteed by the voltage regulator (accuracy  $\pm 5\%$ ) under given input voltage, output current, and temperature conditions. Changes in these conditions will result in an output voltage that may exceed specification limits. For details, please refer to electrical characteristics and characteristics data.

**2. Line regulation ( $\Delta V_{OUT}/\Delta V_{IN} \times V_{OUT}$ )**

This value represents the degree of dependence of the output voltage on the input voltage. It shows the change in output voltage for a given change in input voltage, with output current fixed.

**3. Load regulation ( $\Delta V_{OUT}$ )**

This value represents the degree of dependence of the output voltage on the output current. It quantifies the change in output voltage for a given change in output current, with input voltage fixed.

**4. Input/output voltage difference ( $V_{dif}$ )**

Inputting a product's output voltage ( $V_{OUT}$ ) + input/output voltage difference ( $V_{dif}$ ) to  $V_{IN}$  causes output of  $V_{OUT} \times 95\%$ . A low  $V_{dif}$  value suggests that a regulator is (1) capable of delivering constant output voltages even with marginal (low) input voltages, and (2) capable of outputting substantial current. For these reasons, a low  $V_{dif}$  value is desirable.

Note :  $V_{dif}$  is highly dependent on  $I_{OUT}$  .

■ **Operation**

1 **Basic operation**

Figure 11 shows the block diagram of the S-802/812 Series. The error amplifier compares a reference voltage  $V_{REF}$  with a part of the output voltage fed back by the feedback resistors  $R_A$  and  $R_B$ . It supplies the control transistor with the base current, needed to keep a stable output voltage range not influenced by input voltage or temperature fluctuation.

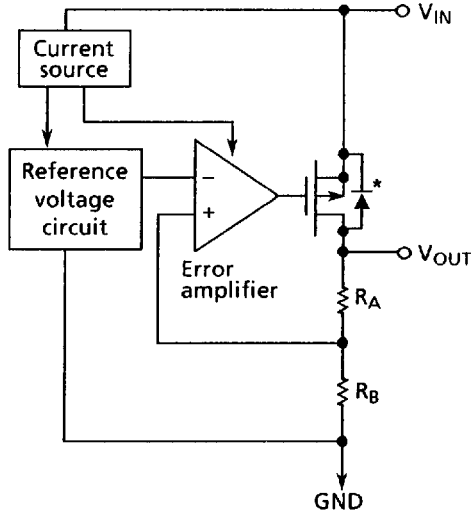

\* Parasitic diode

**Figure 11 Reference block diagram**

2 **Internal circuit**

2.1 **Reference voltage circuit**

In a voltage regulator, the reference voltage circuit plays a very important role because any abnormality will show up directly at an output.

The S-802/812 Series have 0.8 V typical stable voltage circuit (Figure 12) as a highly stable reference voltage source.

Features:

- Low power consumption
- Good temperature characteristic

2.2 **Error amplifier**

The error amplifier consumes 0.5  $\mu$ A of current because it is a differential amplifier in a stable current circuit.

Features:

- Good relation characteristics
- Wide operating voltage range
- Low offset voltage

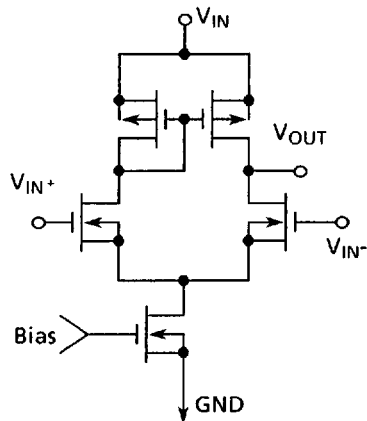

**Figure 12 Error amplifier**

### 2.3 Control transistor

The S-812 Series has a Pch MOS transistor as the current control transistor shown in Figure 13. Therefore an output current  $I_{OUT}$  is expressed by the following formula where is only a small difference between input and output voltages:

$$I_{OUT} = KP \{ 2(V_{GS} - V_{TP})(V_{IN} - V_{OUT}) - (V_{IN} - V_{OUT})^2 \}$$

\* KP : Conductive efficiency

$V_{TP}$  : Threshold voltage of a control transistor

Setting KP to the large value results in a voltage regulator with 30 mV typical output voltage.

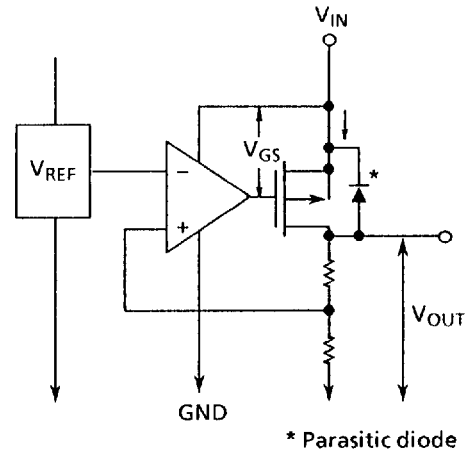

Figure 13 Control transistor

### 3 Temperature characteristic of output voltage

The temperature characteristic of the output voltage is expressed by the following formula in the range of  $-20^{\circ}\text{C}$  to  $70^{\circ}\text{C}$ .

$$\frac{V_{OUT}}{V_{REF}} \times (\pm 0.1) \text{ mV}/^{\circ}\text{C typ.}$$

\*  $V_{REF}$  is 0.7 V min., 0.8 V typ., 0.9 V max.

## ■ Standard Circuits

The basic circuits using the S-802/812 Series are shown in Figure 14.

#### 1. S-802 Series

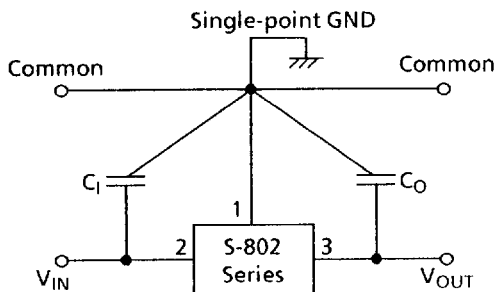

#### 2. S-812 Series

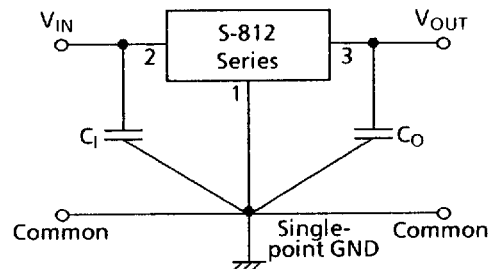

Figure 14 Basic circuits with a by-pass capacitor

## Application Circuits

### 1. High output current positive voltage regulator

Figure 15 shows a circuit for increasing the output current capacitance.

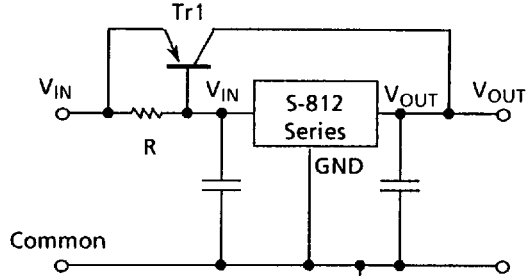

Figure 15

Short-circuit protection of Tr1 is possible by adding the sense resistor  $R_S$  and the PNP transistor shown in Figure 16.

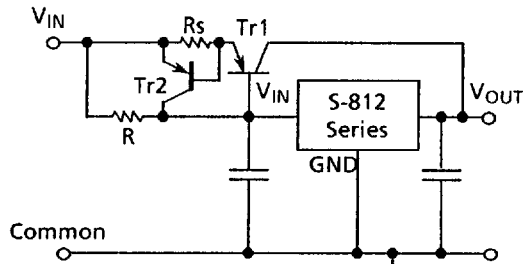

Figure 16

### 2. Circuits for increasing output voltage

If the output voltage you need cannot be found in our product line-up, the designs in Figures 17 or 18 will increase output voltages easily.

$$V_{OUT} = V_{XX} \left(1 + \frac{R_2}{R_1}\right) + I_{SS} R_2 = V_{XX} \left(1 + \frac{R_2}{R_1}\right)$$

Because of its low current consumption, the S-812 Series can set the resistor values  $R_1$  and  $R_2$  high to lower the power consumption of whole systems.

Current flows to the Zener diode (Di) through the current consumption ( $I_{SS}$ ) of the S-812 Series, and the GND terminal rises for the voltage of Di. When Di cannot drive with the current consumption, connection of the resistance R increases the current flowing through Di.

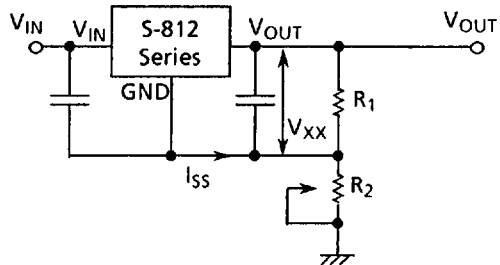

Figure 17

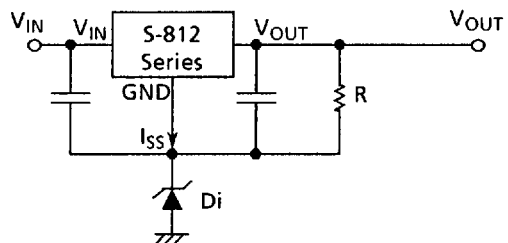

Figure 18 [www.DataSheet4U.com](http://www.DataSheet4U.com)

### 3. Constant current regulator

The S-812 Series can be used as a constant-current regulator within allowable dissipation limits.

$$I_{OUT} = \frac{V_{XX}}{R_A} + I_{SS}$$

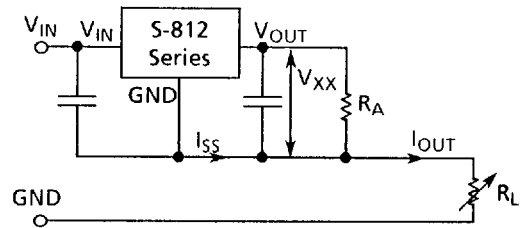

Figure 19 Constant current regulator

### 4. Dual supply

A dual supply can be formed using the S-812 Series.

Figure 20 shows a circuit example for receiving two outputs (5 V and 8 V) with the S-81230AG and the S-81250HG. As the resistance R lets the quiescent current of IC1 pass, R is unnecessary if the minimum load current of IC2 is more than the IC1 quiescent current.

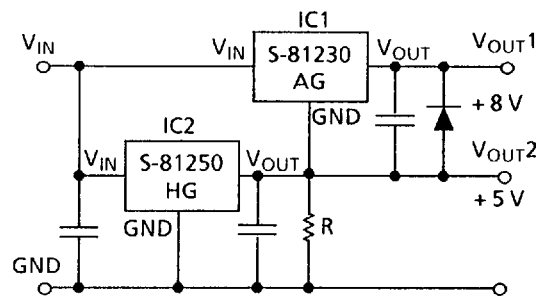

Figure 20 Dual power source

### ■ Notes

- Voltage regulators may oscillate if small or zero capacity is connected to IC input when the impedance of the power source is high and a large capacity is connected to IC output.
- In TO-92 products, since there are projections and resin burrs on roots of lead terminals formed at Tiebar-cut, do not solder on them.
- Because S-802/S-812 Series voltage regulators do not contain short circuit protection circuit, short-circuiting which occurs during mounting or other operations may cause damage to the component.

# S-802/812 Series

- Do not apply a ripple voltage of the conditions below to VIN terminal.

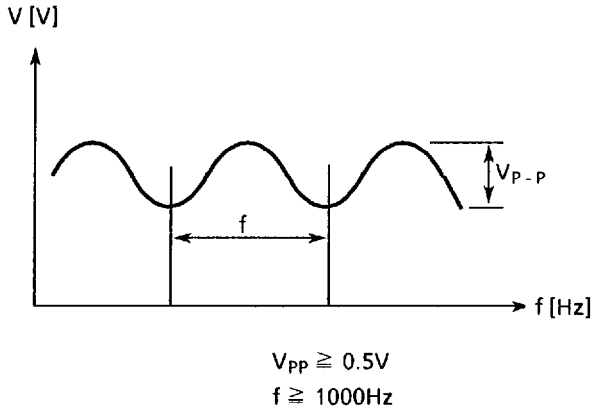

Figure 21

- When connecting the voltage regulator output terminal to another power supply, please insert a diode to protect the IC.

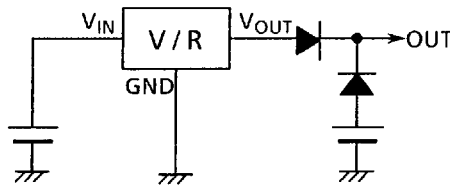

Figure 22

- When designing for mass production using an application circuit described here, keep the deviation of components and temperature characteristic.



## ■ Characteristics

### 1 Input voltage - output voltage

1.1 S-80250AG, S-80250AG-GB-X

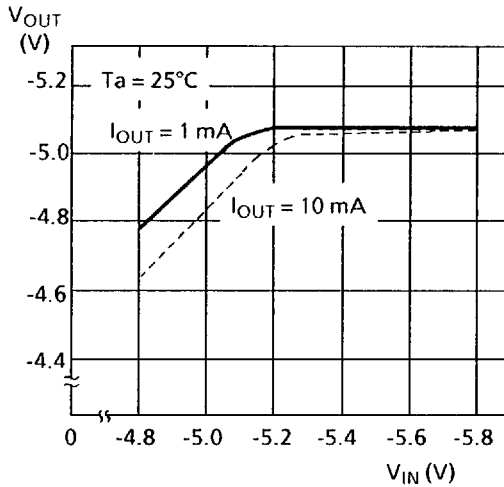

1.2 S-81215AG, S-81215AG-RK-X

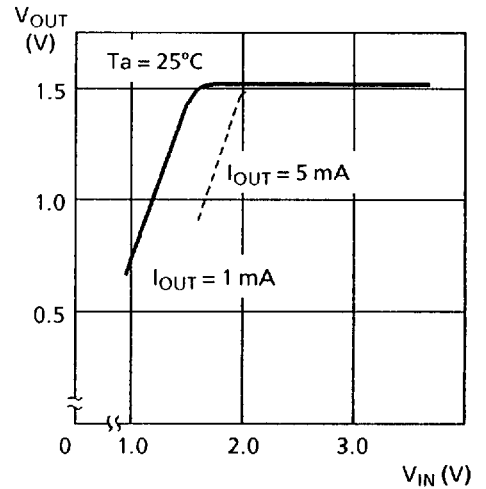

1.3 S-81225AG-RH-X

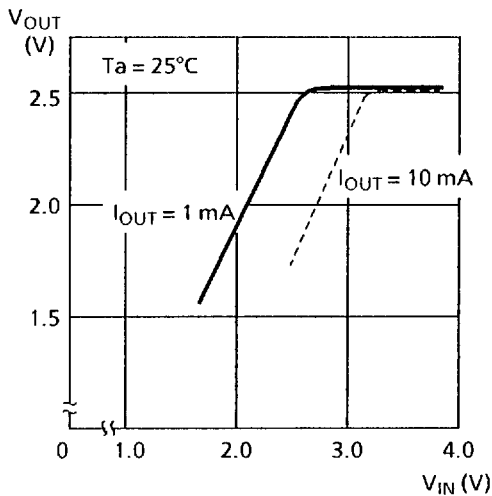

1.4 S-81230AG, S-81230AG-RB-X

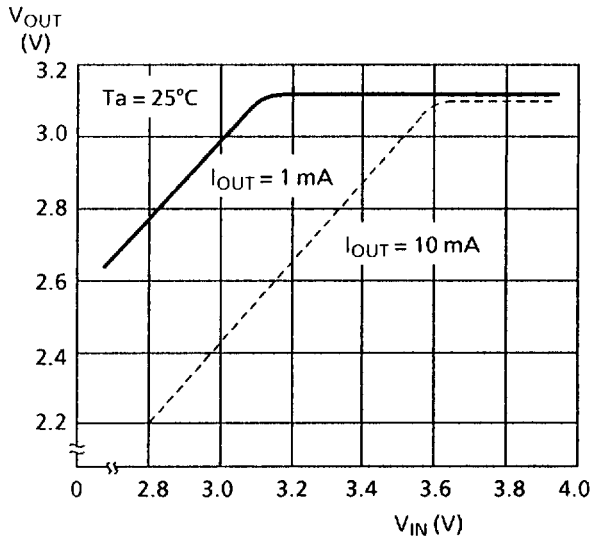

# S-802/812 Series

1.5 S-81240AG-RJ-X

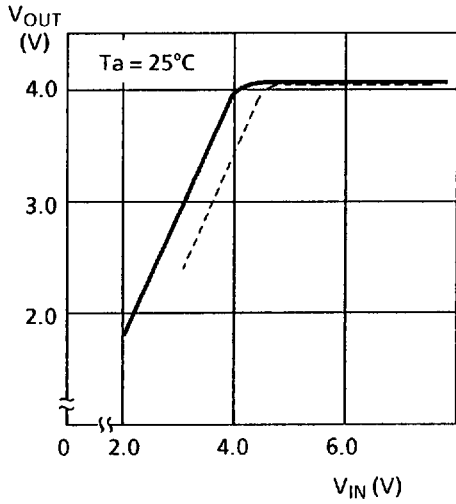

1.6 S-81250HG, S-81250HG-RD-X

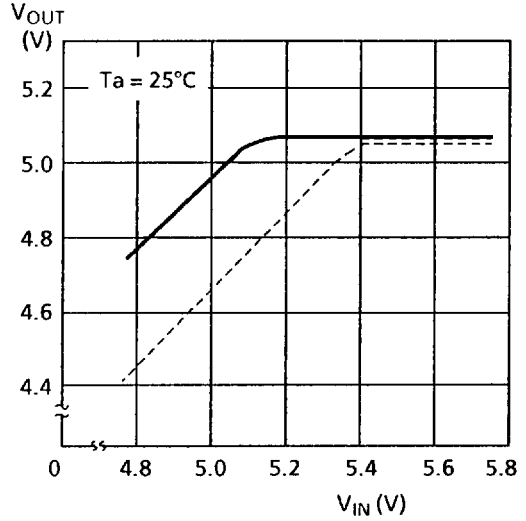

—  $I_{OUT} = 1\text{ mA}$   
 - - -  $I_{OUT} = 10\text{ mA}$

## 2. Output current - output voltage

2.1 S-80250AG, S-80250AG-GB-X

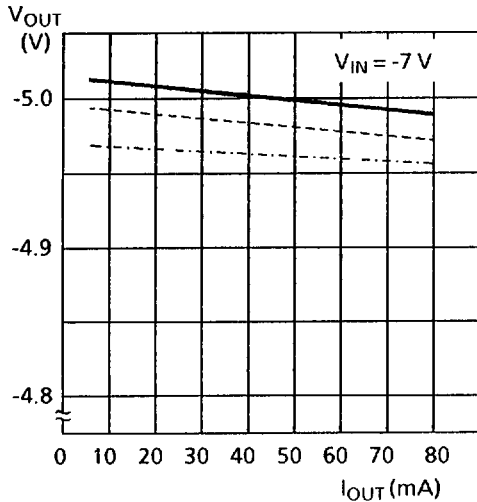

2.2 S-81215AG, S-81215AG-RK-X

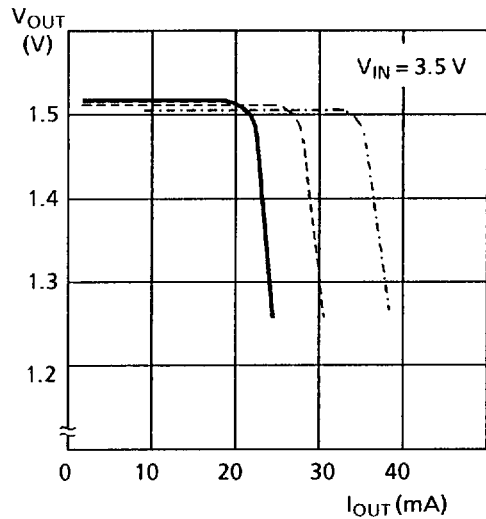

—  $T_a = 75^\circ\text{C}$   
 - - -  $T_a = 25^\circ\text{C}$   
 ····  $T_a = -25^\circ\text{C}$

2.3 S-81225AG-RH-X

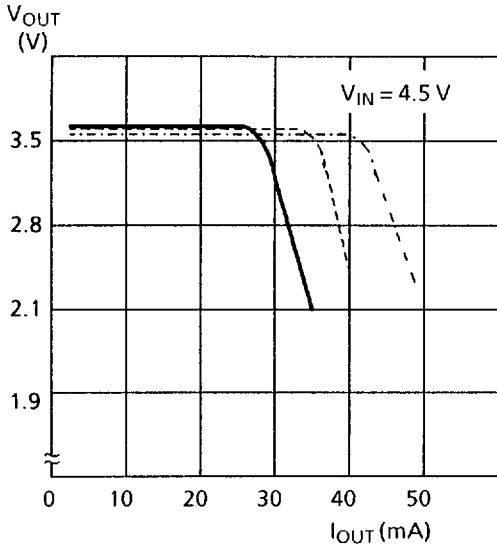

2.4 S-81230AG, S-81230AG-RB-X

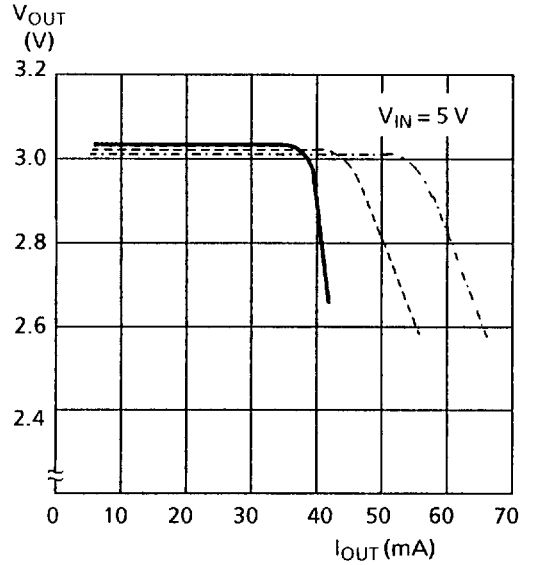

2.5 S-81240AG-RJ-X

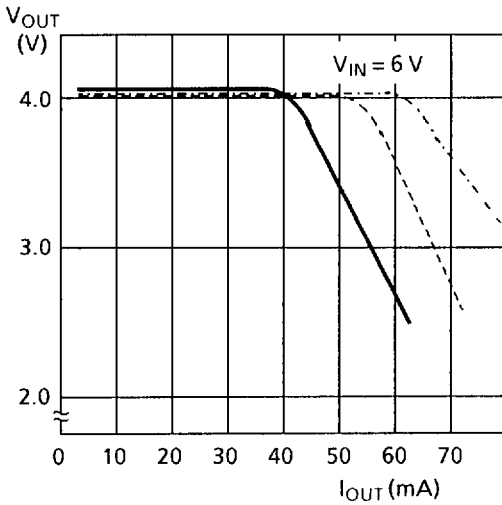

2.6 S-81250HG, S-81250HG-RD-X

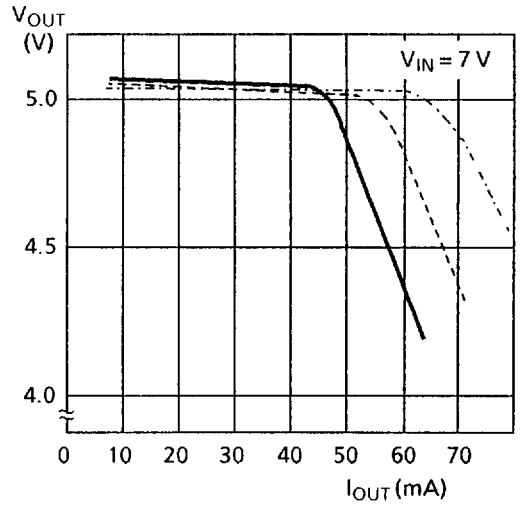

—————  $T_a = 75^\circ C$   
 - - - - -  $T_a = 25^\circ C$   
 - · - · -  $T_a = -25^\circ C$

# S-802/812 Series

## 3. Line transient response characteristics ( $T_a = 25^\circ\text{C}$ ) (S-81250HG)

### 3.1 $I_{\text{OUT}} = 1 \text{ mA}$

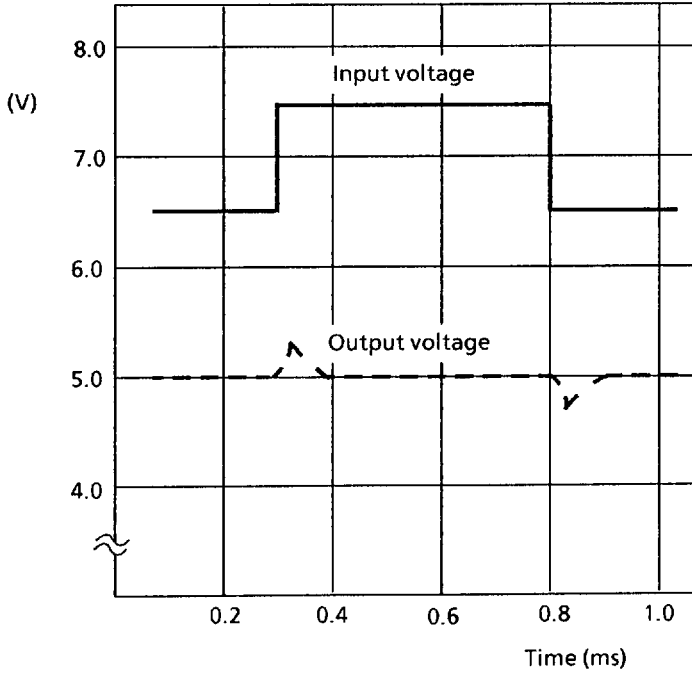

### 3.2 $I_{\text{OUT}} = 10 \text{ mA}$

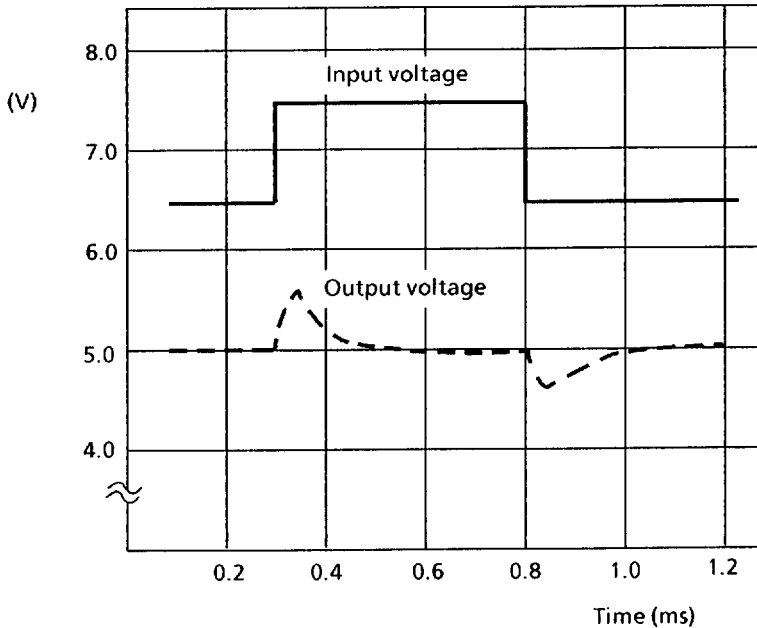

## 4. Input voltage - output voltage

### 4.1 S-80250AG, S-80250AG-GB-X

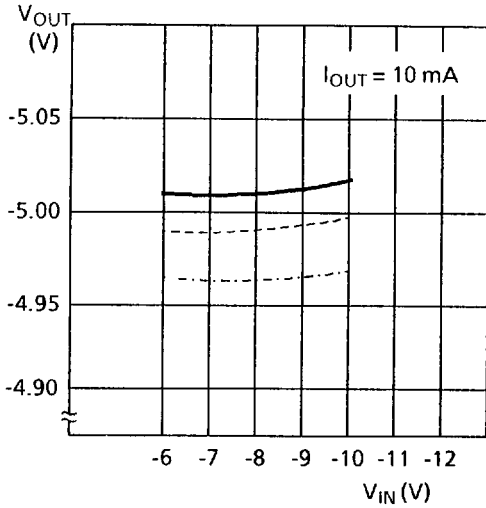

### 4.2 S-81215AG, S-81215AG-RK-X

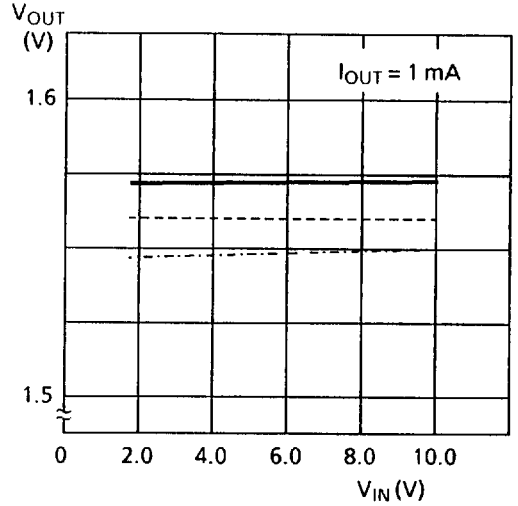

### 4.3 S-81225AG-RH-X

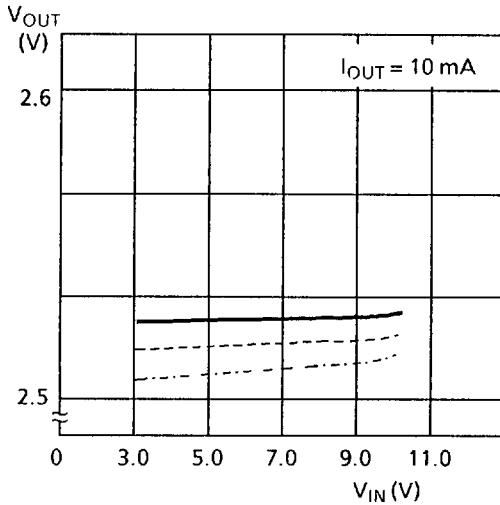

### 4.4 S-81230AG, S-81230AG-RB-X

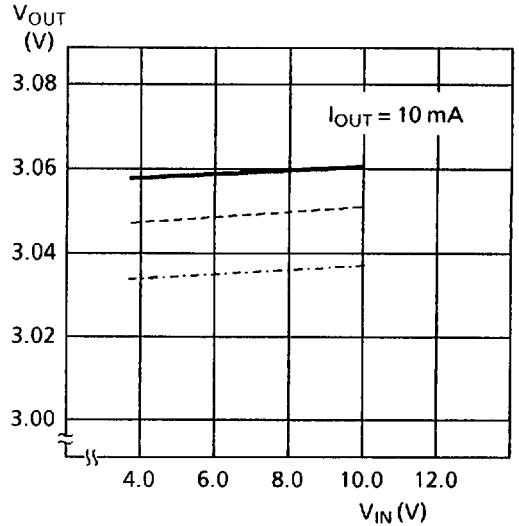

—————  $T_a = 75^\circ\text{C}$   
 - - - - -  $T_a = 25^\circ\text{C}$   
 - · - · -  $T_a = -25^\circ\text{C}$

# S-802/812 Series

4.5 S-81240AG-RJ-X

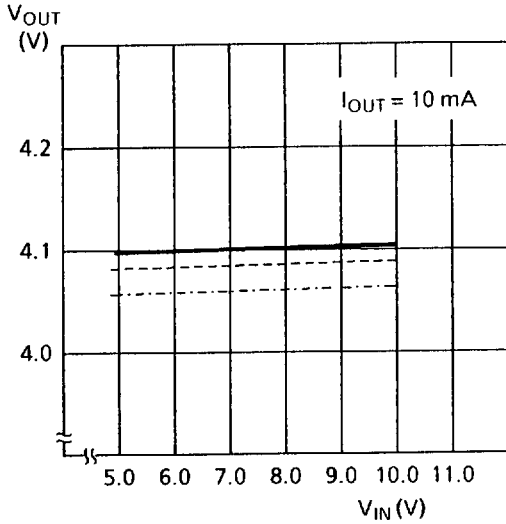

4.6 S-81250HG, S-81250HG-RD-X

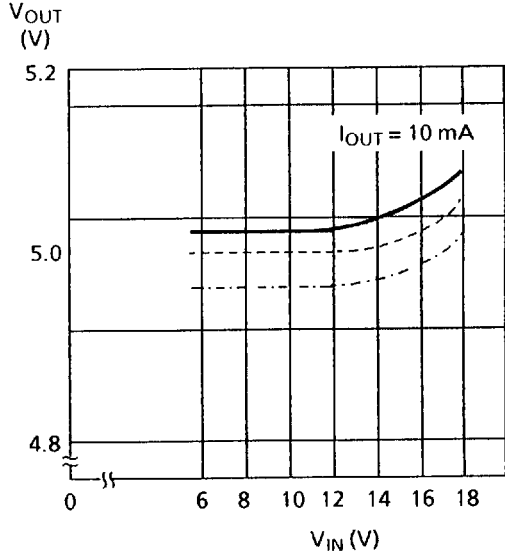

## 5. Current consumption characteristics

5.1 S-80250AG, S-80250AG-GB-X

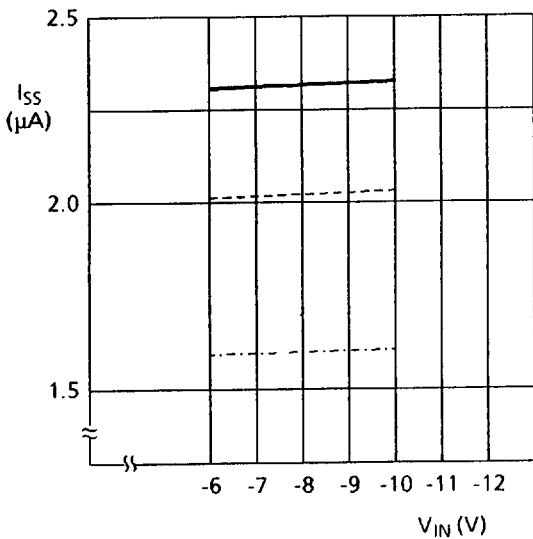

5.2 S-81215AG, S-81215AG-RK-X

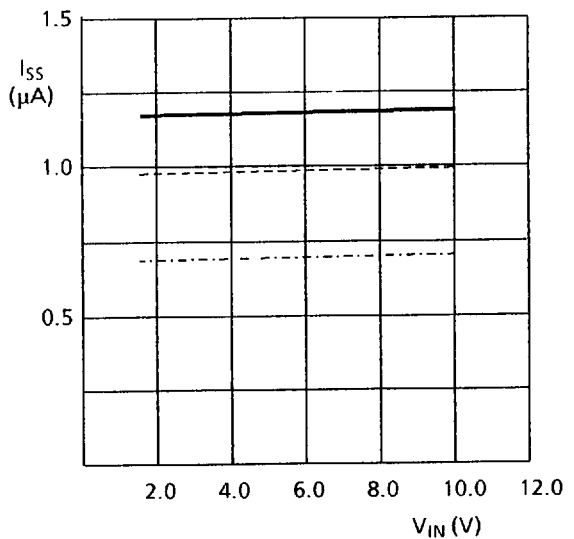

———  $T_a = 75^\circ\text{C}$   
 - - - -  $T_a = 25^\circ\text{C}$   
 ·····  $T_a = -25^\circ\text{C}$

5.3 S-81225AG-RH-X

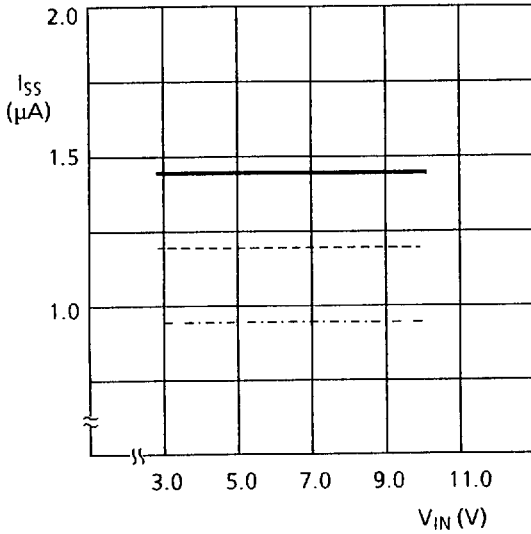

5.4 S-81230AG, S-81230AG-RB-X

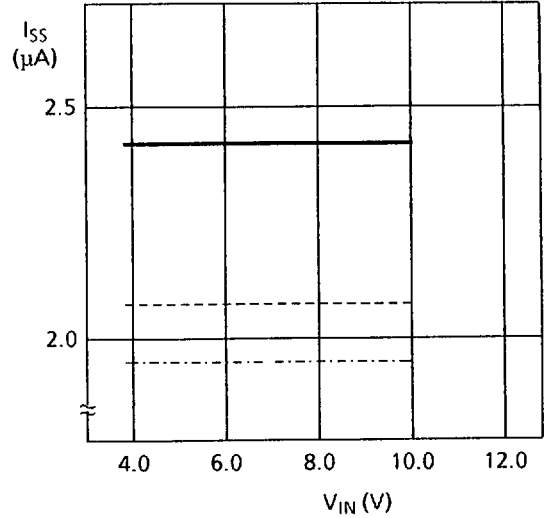

5.5 S-81240AG-RJ-X

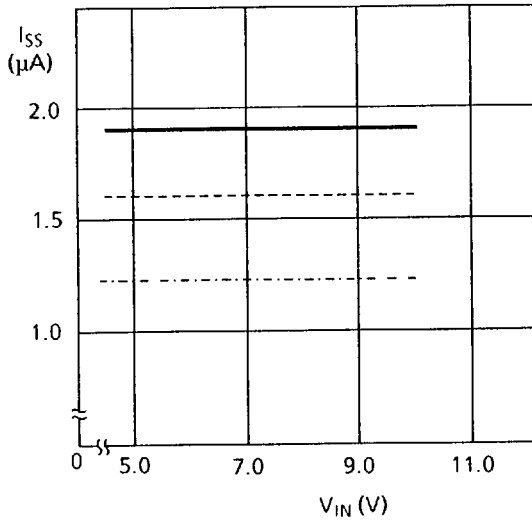

5.6 S-81250HG, S-81250HG-RD-X

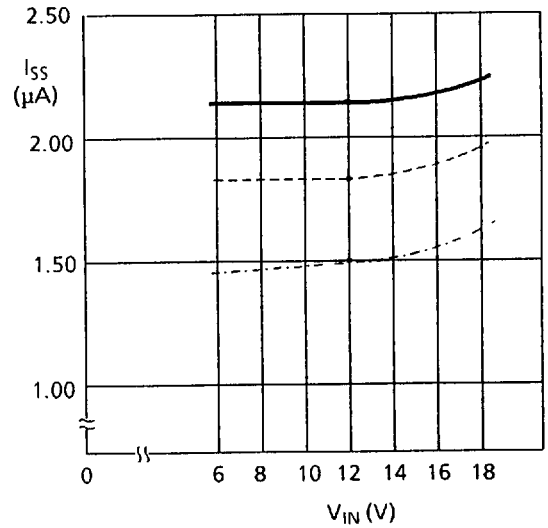

——— Ta = 75°C  
 - - - - - Ta = 25°C  
 ······ Ta = -25°C

# S-802/812 Series

## 6. Temperature characteristic of output voltages

### 6.1 S-80250AG, S-80250AG-GB-X

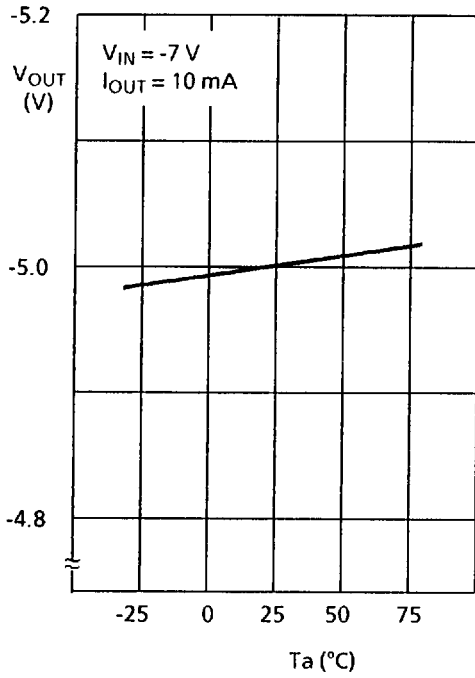

### 6.2 S-81215AG, S-81215AG-RK-X

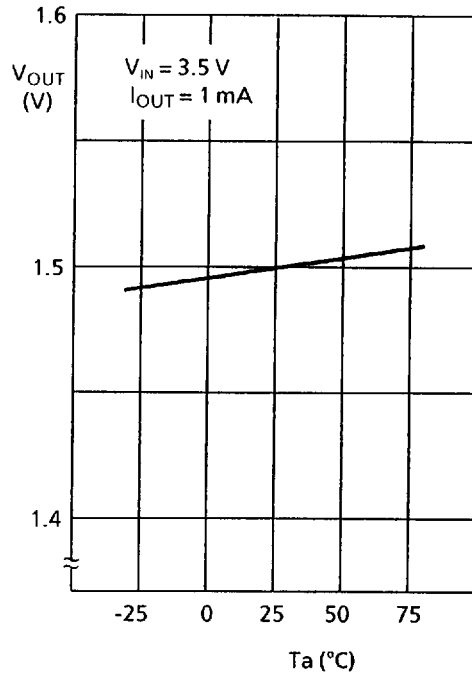

### 6.3 S-81225AG-RH-X

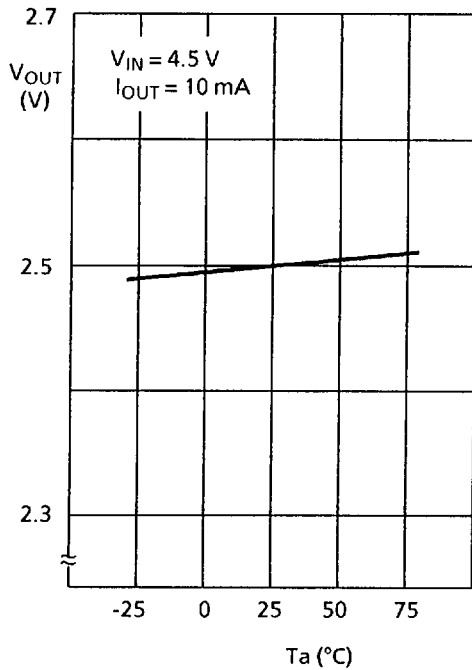

### 6.4 S-81230AG, S-81230AG-RB-X

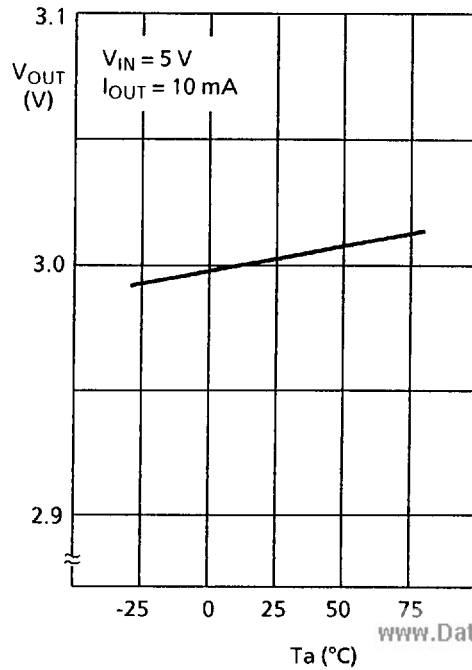



### 6.5 S-81240AG-RJ-X

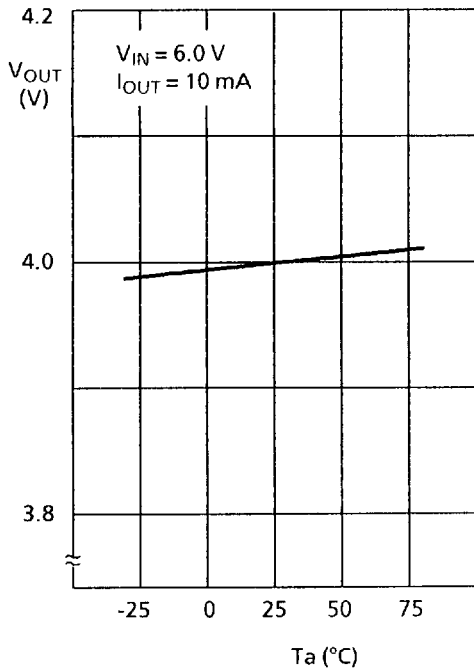

### 6.6 S-81250HG, S-81250HG-RD-X

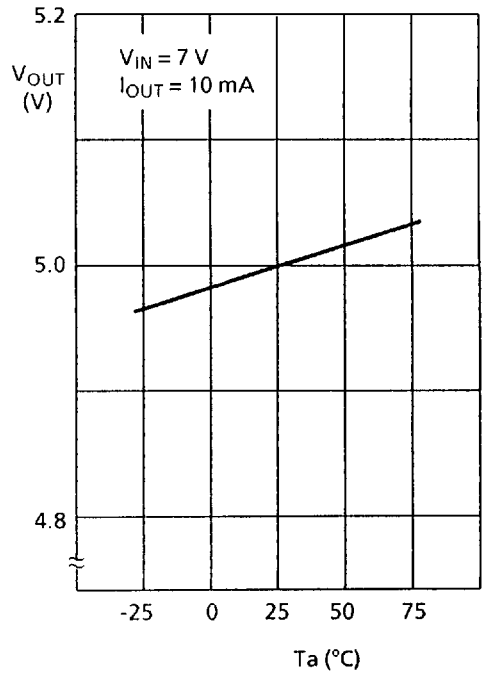

## 7. Measuring circuits (in case of the S-812 Series)

### 1. Input voltage - output voltage

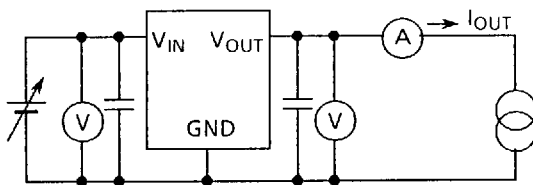

### 2. Output current - output voltage

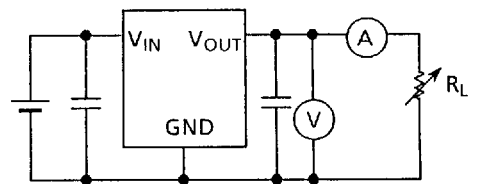

### 3. Line transient response

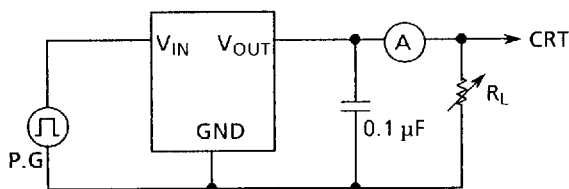

### 4. Current consumption

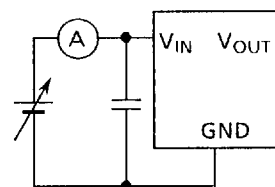

Figure 21