

Rev.1.7\_00

## LOW DROPOUT CMOS VOLTAGE REGULATOR

## S-814 Series

The S-814 Series is a low dropout voltage, high output voltage accuracy and low current consumption positive voltage regulator developed utilizing CMOS technology. Built-in low ON-resistance transistors provide low dropout voltage and large output current. A shutdown circuit ensures long battery life.

Various types of output capacitors can be used in the S-814 Series compared with the past CMOS voltage regulators. (i.e., Small ceramic capacitors can also be used in the S-814 Series.)

The SOT-23-5 miniaturized package and the SOT-89-5 packages are recommended to use for configuring portable devices and large output current applications, respectively.

### ■ Features

- Low current consumption
  - At operation mode: Typ. 30  $\mu$ A, Max. 40  $\mu$ A
  - At shutdown mode: Typ. 100 nA, Max. 500 nA
- Output voltage: 0.1 V steps between 2.0 and 6.0 V
- High accuracy output voltage:  $\pm 2.0$  %
- Output current:
  - 110 mA capable: 3.0 V output product, at  $V_{IN}=4$  V<sup>\*1</sup>
  - 180 mA capable: 5.0 V output product, at  $V_{IN}=6$  V<sup>\*1</sup>
- Low dropout voltage: Typ. 170 mV: 5.0 V output product, at  $I_{OUT}=60$  mA
- Built-in shutdown circuit
- Built-in short-circuit protection
- Low ESR capacitor, e.g. a ceramic capacitor of 0.47  $\mu$ F or more, can be used as the output capacitor.
- Small package: SOT-23-5 and SOT-89-5

\*1. Attention should be paid to the power dissipation of the package when the output current is large.

### ■ Applications

- Power source for battery-powered devices, personal communication devices, and home electric/electronic appliances.

### ■ Packages

Package Name	Drawing Code		
	Package	Tape	Reel
SOT-23-5	MP005-A	MP005-A	MP005-A
SOT-89-5	UP005-A	UP005-A	UP005-A

# LOW DROPOUT CMOS VOLTAGE REGULATOR

## S-814 Series

Rev.1.7\_00

### ■ Block Diagram

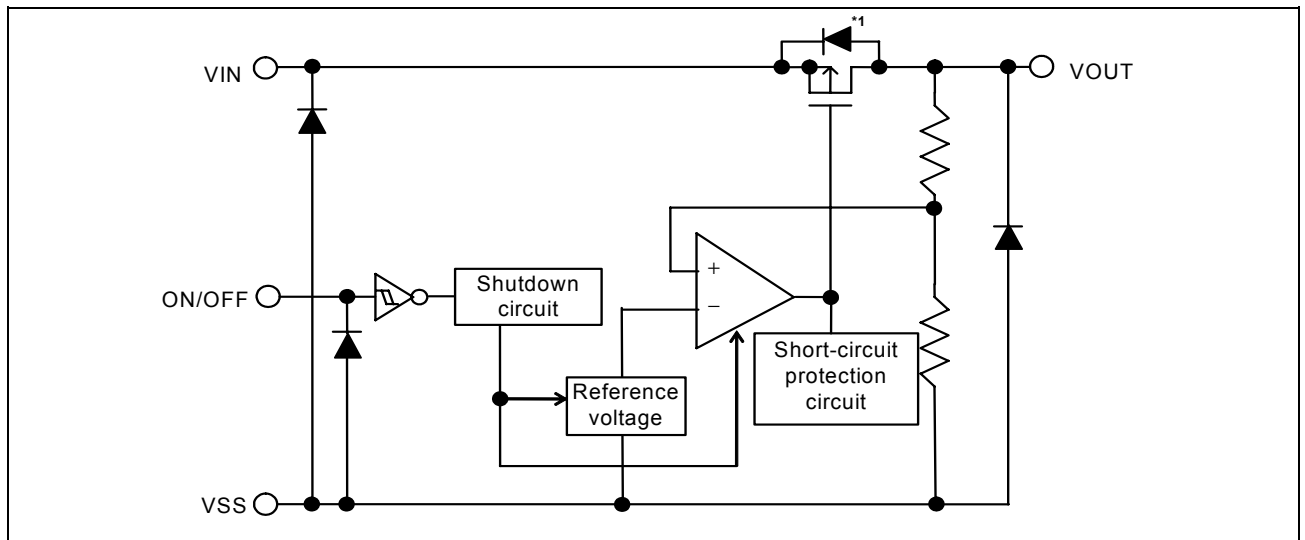

\*1. Parasitic diode

Figure 1

## ■ Product Name Structure

### 1. Product Name

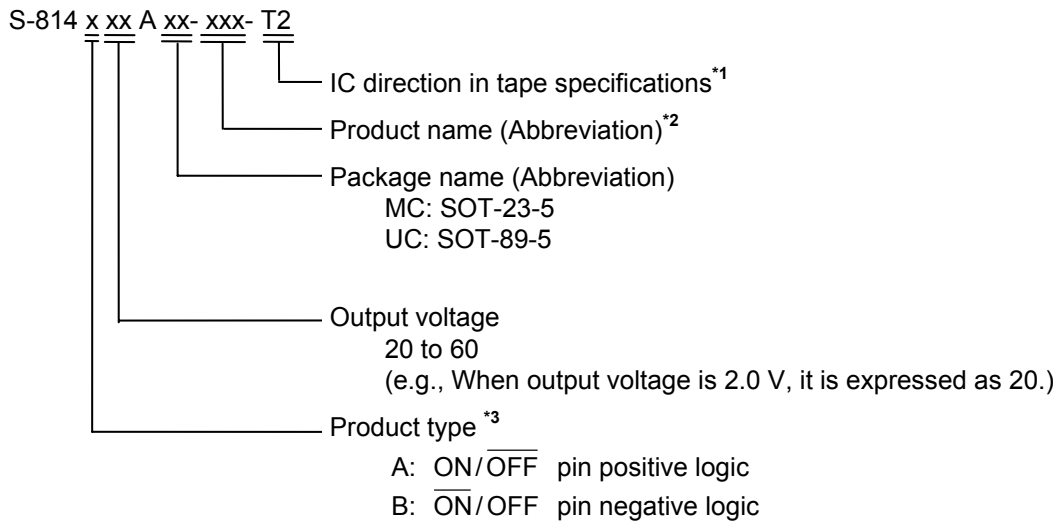

**\*1.** Refer to the taping specifications at the end of this book.

**\*2.** Refer to the **Table 1** in “**2. Product name list**”.

**\*3.** Refer to “**3. ON/OFF pin (Shutdown pin)**” in “**■ Operation**”.

## LOW DROPOUT CMOS VOLTAGE REGULATOR

### S-814 Series

Rev.1.7\_00

#### 2. Product Name List

Table1

Output voltage	SOT-23-5	SOT-89-5
2.0 V±2.0 %	S-814A20AMC-BCK-T2	S-814A20AUC-BCK-T2
2.1 V±2.0 %	S-814A21AMC-BCL-T2	S-814A21AUC-BCL-T2
2.2 V±2.0 %	S-814A22AMC-BCM-T2	S-814A22AUC-BCM-T2
2.3 V±2.0 %	S-814A23AMC-BCN-T2	S-814A23AUC-BCN-T2
2.4 V±2.0 %	S-814A24AMC-BCO-T2	S-814A24AUC-BCO-T2
2.5 V±2.0 %	S-814A25AMC-BCP-T2	S-814A25AUC-BCP-T2
2.6 V±2.0 %	S-814A26AMC-BCQ-T2	S-814A26AUC-BCQ-T2
2.7 V±2.0 %	S-814A27AMC-BCR-T2	S-814A27AUC-BCR-T2
2.8 V±2.0 %	S-814A28AMC-BCS-T2	S-814A28AUC-BCS-T2
2.9 V±2.0 %	S-814A29AMC-BCT-T2	S-814A29AUC-BCT-T2
3.0 V±2.0 %	S-814A30AMC-BCU-T2	S-814A30AUC-BCU-T2
3.1 V±2.0 %	S-814A31AMC-BCV-T2	S-814A31AUC-BCV-T2
3.2 V±2.0 %	S-814A32AMC-BCW-T2	S-814A32AUC-BCW-T2
3.3 V±2.0 %	S-814A33AMC-BCX-T2	S-814A33AUC-BCX-T2
3.4 V±2.0 %	S-814A34AMC-BCY-T2	S-814A34AUC-BCY-T2
3.5 V±2.0 %	S-814A35AMC-BCZ-T2	S-814A35AUC-BCZ-T2
3.6 V±2.0 %	S-814A36AMC-BDA-T2	S-814A36AUC-BDA-T2
3.7 V±2.0 %	S-814A37AMC-BDB-T2	S-814A37AUC-BDB-T2
3.8 V±2.0 %	S-814A38AMC-BDC-T2	S-814A38AUC-BDC-T2
3.9 V±2.0 %	S-814A39AMC-BDD-T2	S-814A39AUC-BDD-T2
4.0 V±2.0 %	S-814A40AMC-BDE-T2	S-814A40AUC-BDE-T2
4.1 V±2.0 %	S-814A41AMC-BDF-T2	S-814A41AUC-BDF-T2
4.2 V±2.0 %	S-814A42AMC-BDG-T2	S-814A42AUC-BDG-T2
4.3 V±2.0 %	S-814A43AMC-BDH-T2	S-814A43AUC-BDH-T2
4.4 V±2.0 %	S-814A44AMC-BDI-T2	S-814A44AUC-BDI-T2
4.5 V±2.0 %	S-814A45AMC-BDJ-T2	S-814A45AUC-BDJ-T2
4.6 V±2.0 %	S-814A46AMC-BDK-T2	S-814A46AUC-BDK-T2
4.7 V±2.0 %	S-814A47AMC-BDL-T2	S-814A47AUC-BDL-T2
4.8 V±2.0 %	S-814A48AMC-BDM-T2	S-814A48AUC-BDM-T2
4.9 V±2.0 %	S-814A49AMC-BDN-T2	S-814A49AUC-BDN-T2
5.0 V±2.0 %	S-814A50AMC-BDO-T2	S-814A50AUC-BDO-T2
5.1 V±2.0 %	S-814A51AMC-BDP-T2	S-814A51AUC-BDP-T2
5.2 V±2.0 %	S-814A52AMC-BDQ-T2	S-814A52AUC-BDQ-T2
5.3 V±2.0 %	S-814A53AMC-BDR-T2	S-814A53AUC-BDR-T2
5.4 V±2.0 %	S-814A54AMC-BDS-T2	S-814A54AUC-BDS-T2
5.5 V±2.0 %	S-814A55AMC-BDT-T2	S-814A55AUC-BDT-T2
5.6 V±2.0 %	S-814A56AMC-BDU-T2	S-814A56AUC-BDU-T2
5.7 V±2.0 %	S-814A57AMC-BDV-T2	S-814A57AUC-BDV-T2
5.8 V±2.0 %	S-814A58AMC-BDW-T2	S-814A58AUC-BDW-T2
5.9 V±2.0 %	S-814A59AMC-BDX-T2	S-814A59AUC-BDX-T2
6.0 V±2.0 %	S-814A60AMC-BDY-T2	S-814A60AUC-BDY-T2

**Remark** Please contact the SII marketing department for type B products.

## ■ Pin Configurations

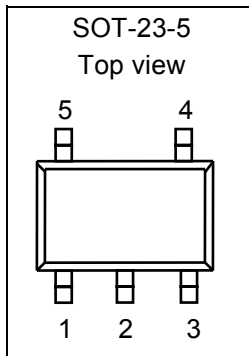

**Figure 2**

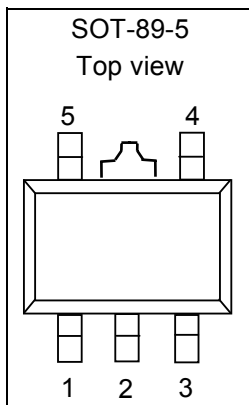

**Figure 3**

**Table 2**

Pin No.	Symbol	Pin description
1	VIN	Voltage input pin
2	VSS	GND pin
3	ON/OFF	Shutdown pin
4	NC*1	No connection
5	VOUT	Voltage output pin

\*1. The NC pin is electrically open.

The NC pin can be connected to VIN or VSS.

**Table 3**

Pin No.	Symbol	Pin description
1	VOUT	Voltage output pin
2	VSS	GND pin
3	NC*1	No connection
4	ON/OFF	Shutdown pin
5	VIN	Voltage input pin

\*1. The NC pin is electrically open.

The NC pin can be connected to VIN or VSS.

# LOW DROPOUT CMOS VOLTAGE REGULATOR

## S-814 Series

Rev.1.7\_00

### ■ Absolute Maximum Ratings

Table 4

(Ta=25°C unless otherwise specified)

Item	Symbol	Absolute maximum rating		Unit
Input voltage	$V_{IN}$	$V_{SS}-0.3$ to $V_{SS}+12$		V
	$V_{ON/OFF}$	$V_{SS}-0.3$ to $V_{SS}+12$		
Output voltage	$V_{OUT}$	$V_{SS}-0.3$ to $V_{IN}+0.3$		
Power dissipation	$P_D$	SOT-23-5	250	mW
		SOT-89-5	500	
Operating ambient temperature	$T_{opr}$	-40 to +85		°C
Storage temperature	$T_{stg}$	-40 to +125		

**Caution** The absolute maximum ratings are rated values exceeding which the product could suffer physical damage. These values must therefore not be exceeded under any conditions.

## LOW DROPOUT CMOS VOLTAGE REGULATOR S-814 Series

Rev.1.7\_00

### ■ Electrical Characteristics

Table 5

(Ta=25°C unless otherwise specified)

Item	Symbol	Conditions	Min.	Typ.	Max.	Units	Test circuit	
Output voltage*1	$V_{OUT(E)}$	$V_{IN}=V_{OUT(S)}+1\text{ V}$ , $I_{OUT}=30\text{ mA}$	$V_{OUT(S)} \times 0.98$	$V_{OUT(S)}$	$V_{OUT(S)} \times 1.02$	V	1	
Output current*2	$I_{OUT}$	$V_{OUT(S)}+1\text{ V} \leq V_{IN} \leq 10\text{ V}$	$2.0\text{ V} \leq V_{OUT(S)} \leq 2.9\text{ V}$	$100^{*3}$	—	—	mA	3
			$3.0\text{ V} \leq V_{OUT(S)} \leq 3.9\text{ V}$	$110^{*3}$	—	—		
			$4.0\text{ V} \leq V_{OUT(S)} \leq 4.9\text{ V}$	$135^{*3}$	—	—		
			$5.0\text{ V} \leq V_{OUT(S)} \leq 6.0\text{ V}$	$180^{*3}$	—	—		
Dropout voltage*4	$V_{drop}$	$I_{OUT}=60\text{ mA}$	$2.0\text{ V} \leq V_{OUT(S)} \leq 2.4\text{ V}$	—	0.51	0.87	V	1
			$2.5\text{ V} \leq V_{OUT(S)} \leq 2.9\text{ V}$	—	0.38	0.61		
			$3.0\text{ V} \leq V_{OUT(S)} \leq 3.4\text{ V}$	—	0.30	0.44		
			$3.5\text{ V} \leq V_{OUT(S)} \leq 3.9\text{ V}$	—	0.24	0.33		
			$4.0\text{ V} \leq V_{OUT(S)} \leq 4.4\text{ V}$	—	0.20	0.26		
			$4.5\text{ V} \leq V_{OUT(S)} \leq 4.9\text{ V}$	—	0.18	0.22		
			$5.0\text{ V} \leq V_{OUT(S)} \leq 5.4\text{ V}$	—	0.17	0.21		
			$5.5\text{ V} \leq V_{OUT(S)} \leq 6.0\text{ V}$	—	0.17	0.20		
Line regulation 1	$\frac{\Delta V_{OUT1}}{\Delta V_{IN} \bullet V_{OUT}}$	$V_{OUT(S)}+0.5\text{ V} \leq V_{IN} \leq 10\text{ V}$ , $I_{OUT}=30\text{ mA}$	—	0.05	0.2	%V	1	
Line regulation 2	$\frac{\Delta V_{OUT2}}{\Delta V_{IN} \bullet V_{OUT}}$	$V_{OUT(S)}+0.5\text{ V} \leq V_{IN} \leq 10\text{ V}$ , $I_{OUT}=10\text{ }\mu\text{A}$	—	0.05	0.2			
Load regulation	$\Delta V_{OUT3}$	$V_{IN}=V_{OUT(S)}+1\text{ V}$ , $10\text{ }\mu\text{A} \leq I_{OUT} \leq 80\text{ mA}$	—	30	50	mV	1	
Output voltage temperature coefficient*5	$\frac{\Delta V_{OUT}}{\Delta T_a \bullet V_{OUT}}$	$V_{IN}=V_{OUT(S)}+1\text{ V}$ , $I_{OUT}=30\text{ mA}$ , $-40^\circ\text{C} \leq T_a \leq 85^\circ\text{C}$	—	$\pm 100$	—	ppm/ °C		
Current consumption during operation	$I_{SS1}$	$V_{IN}=V_{OUT(S)}+1\text{ V}$ , ON/OFF pin=ON, No load	—	30	40	$\mu\text{A}$	2	
Current consumption during shutdown	$I_{SS2}$	$V_{IN}=V_{OUT(S)}+1\text{ V}$ , ON/OFF pin=OFF, No load	—	0.1	0.5			
Input voltage	$V_{IN}$	—	—	—	10	V	1	
ON/OFF pin input voltage "H"	$V_{SH}$	$V_{IN}=V_{OUT(S)}+1\text{ V}$ , $R_L=1\text{ k}\Omega$ , Judged at $V_{OUT}$ level	1.5	—	—			4
ON/OFF pin input voltage "L"	$V_{SL}$	$V_{IN}=V_{OUT(S)}+1\text{ V}$ , $R_L=1\text{ k}\Omega$ , Judged at $V_{OUT}$ level	—	—	0.3			
ON/OFF pin input current "H"	$I_{SH}$	$V_{IN}=V_{OUT(S)}+1\text{ V}$ , $V_{ON/OFF}=7\text{ V}$	-0.1	—	0.1	$\mu\text{A}$		
ON/OFF pin input current "L"	$I_{SL}$	$V_{IN}=V_{OUT(S)}+1\text{ V}$ , $V_{ON/OFF}=0\text{ V}$	-0.1	—	0.1			
Short current limit	$I_{OS}$	$V_{IN}=V_{OUT(S)}+1\text{ V}$ , $V_{OUT}$ pin=0 V	—	70	—	mA	3	
Ripple rejection	$ RR $	$V_{IN}=V_{OUT(S)}+1\text{ V}$ , $f=100\text{ Hz}$ , $\Delta V_{rip}=0.5\text{ V}_{rms}$ , $I_{OUT}=30\text{ mA}$	—	45	—	dB	5	

\*1.  $V_{OUT(E)}$ : Effective output voltagei.e., The output voltage when fixing  $I_{OUT}(=30\text{ mA})$  and inputting  $V_{OUT(S)}+1.0\text{ V}$ . $V_{OUT(S)}$ : Specified output voltage\*2. Output amperage when output voltage goes below 95 % of  $V_{OUT(E)}$  after gradually increasing output current.

\*3. The output current can be at least this value.

Use load amperage not exceeding this value.

## LOW DROPOUT CMOS VOLTAGE REGULATOR

### S-814 Series

Rev.1.7\_00

\*4.  $V_{\text{drop}} = V_{\text{IN1}} - (V_{\text{OUT(E)}} \times 0.98)$

\*1. Input voltage at which the output voltage falls 98 % of  $V_{\text{OUT(E)}}$  after gradually decreasing the input voltage.

\*5. The change in temperature [mV/°C] is calculated using the following equation.

$$\frac{\Delta V_{\text{OUT}}}{\Delta T_a} [\text{mV} / ^\circ\text{C}] *1 = V_{\text{OUT(S)}} [\text{V}] *2 \times \frac{\Delta V_{\text{OUT}}}{\Delta T_a \bullet V_{\text{OUT}}} [\text{ppm} / ^\circ\text{C}] *3 \div 1000$$

\*1. Change in temperature of the dropout voltage

\*2. Specified output voltage

\*3. Output voltage temperature coefficient



Rev.1.7\_00

### ■ Test Circuits

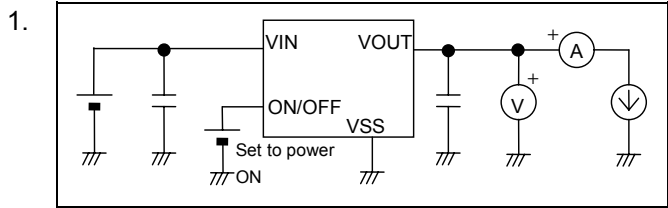

Figure 4

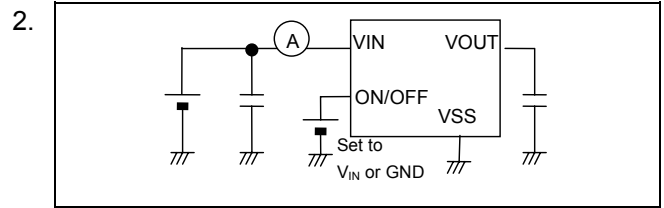

Figure 5

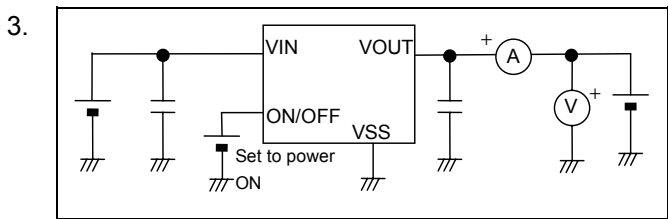

Figure 6

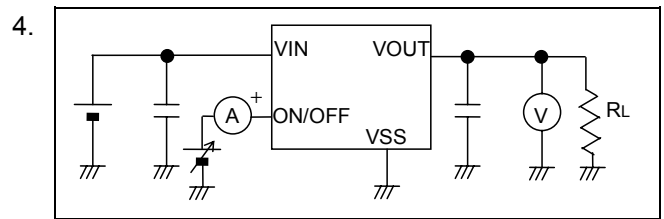

Figure 7

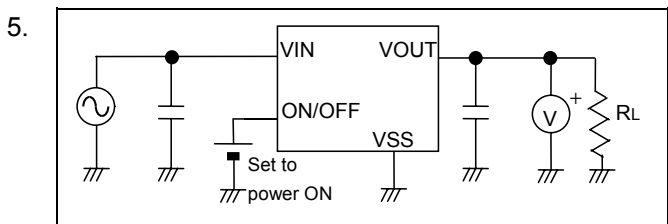

Figure 8

## LOW DROPOUT CMOS VOLTAGE REGULATOR

### S-814 Series

Rev.1.7\_00

#### ■ Standard Circuit

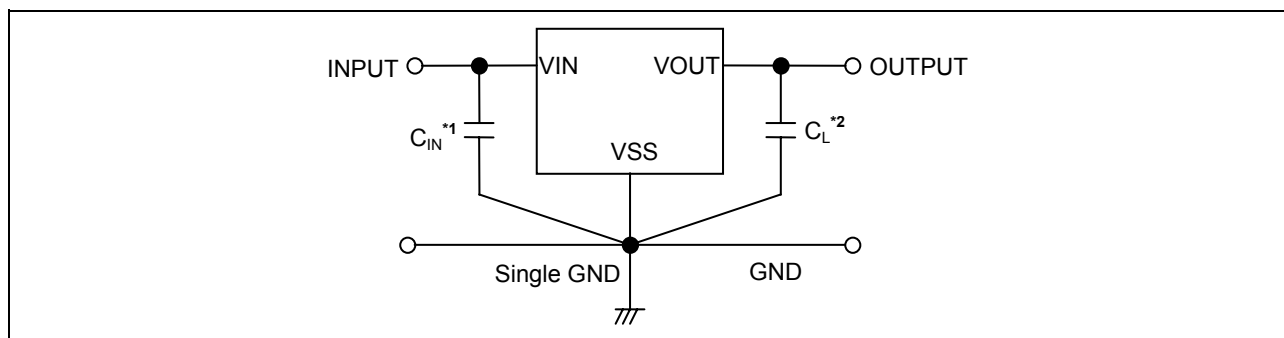

\*1.  $C_{IN}$  is a capacitor used to stabilize input.

\*2. In addition to a tantalum capacitor, a ceramic capacitor of 0.47  $\mu\text{F}$  or more can be used in  $C_L$ .

Figure 9

**Caution** The above connection diagram and constant will not guarantees successful operation. Perform through evaluation using the actual application to set the constant.

#### ■ Technical Terms

##### 1. Low dropout voltage regulator

The low dropout voltage regulator is a voltage regulator featuring a low dropout voltage characteristic due to its internal low ON-resistance characteristic transistors.

##### 2. Low ESR

ESR is the abbreviation for Equivalent Series Resistance. The low ESR output capacitor ( $C_L$ ) can be used in the S-814 Series.

##### 3. Output voltage ( $V_{OUT}$ )

The accuracy of the output voltage is ensured at  $\pm 2.0\%$  under the specified conditions\*1 of input voltage, output current, and temperature, which differ depending upon the product items.

\*1. The condition differs depending upon each product.

**Caution** If you change the above conditions, the output voltage value may vary out of the accuracy range of the output voltage. Refer to the “■ Electrical Characteristics” and “■ Characteristics” for details.

##### 4. Line regulation 1 ( $\Delta V_{OUT1}$ ) and Line regulation 2 ( $\Delta V_{OUT2}$ )

Indicate the input voltage dependencies of output voltage. That is, the value shows how much the output voltage changes due to a change in the input voltage with the output current remained unchanged.

##### 5. Load regulation ( $\Delta V_{OUT3}$ )

Indicates the output current dependencies of output voltage. That is, the value shows how much the output voltage changes due to a change in the output current with the input voltage remained unchanged.

**6. Dropout voltage ( $V_{drop}$ )**

Indicates a difference between input voltage ( $V_{IN1}$ ) and output voltage when output voltage falls by 98 % of  $V_{OUT(E)}$  by gradually decreasing the input voltage.

$$V_{drop} = V_{IN1} - (V_{OUT(E)} \times 0.98)$$

**7. Temperature coefficient of output voltage  $\left( \frac{\Delta V_{OUT}}{\Delta T_a \bullet V_{OUT}} \right)$** 

The shadowed area in **Figure 10** is the range where  $V_{OUT}$  varies in the operating temperature range when the temperature coefficient of the output voltage is  $\pm 100$  ppm/ $^{\circ}\text{C}$ .

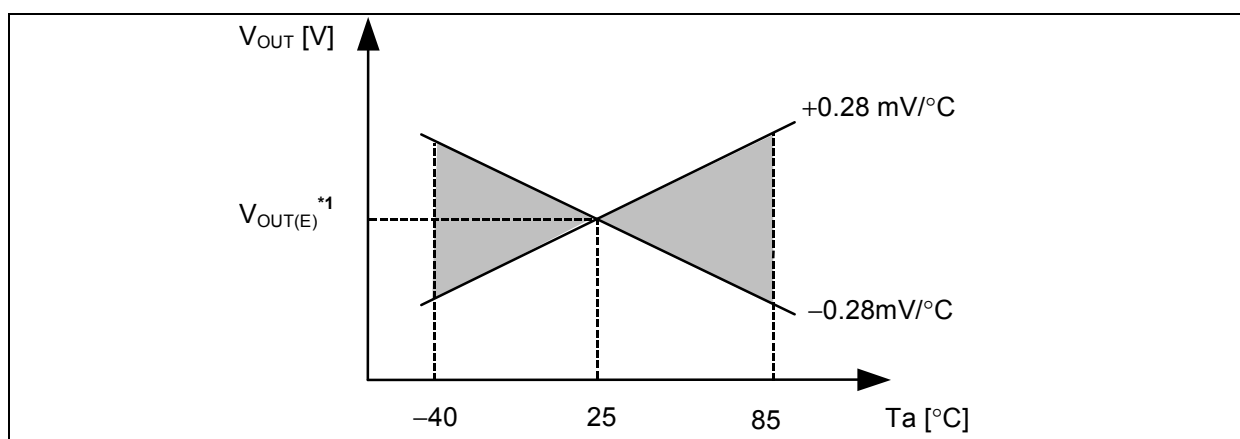

\*1. The measurement value of output voltage at 25°C.

**Figure 10 Typical example of S-814A28A**

A change in temperatures of output voltage [mV/ $^{\circ}\text{C}$ ] is calculated using the following equation.

$$\frac{\Delta V_{OUT}}{\Delta T_a} [\text{mV}/^{\circ}\text{C}] *1 = V_{OUT(S)} [\text{V}] *2 \times \frac{\Delta V_{OUT}}{\Delta T_a \bullet V_{OUT}} [\text{ppm}/^{\circ}\text{C}] *3 \div 1000$$

\*1. The change in temperature of the dropout voltage

\*2. Specified output voltage

\*3. Output voltage temperature coefficient

# LOW DROPOUT CMOS VOLTAGE REGULATOR

## S-814 Series

Rev.1.7\_00

### ■ Operation

#### 1. Basic operation

**Figure 11** shows the block diagram of the S-814 Series.

The error amplifier compares a reference voltage  $V_{ref}$  with part of the output voltage divided by the feedback resistors  $R_s$  and  $R_f$ . It supplies the output transistor with the gate voltage, necessary to ensure certain output voltage free of any fluctuations of input voltage and temperature.

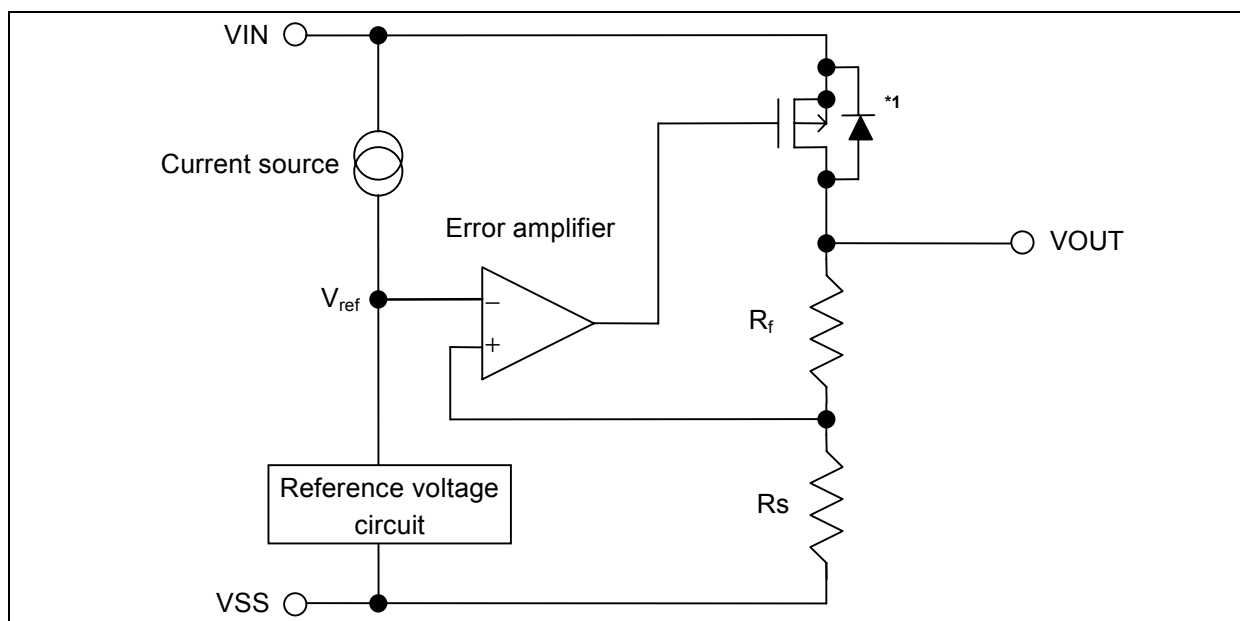

\*1. Parasitic diode

**Figure 11**

#### 2. Output transistor

The S-814 Series uses a low on-resistance Pch MOS FET as the output transistor.

Be sure that  $V_{OUT}$  does not exceed  $V_{IN}+0.3$  V to prevent the voltage regulator from being broken due to inverse current flowing from VOUT pin through a parasitic diode to VIN pin.

### 3. ON/OFF pin (Shutdown pin)

This pin starts and stops the regulator.

When the shutdown pin is switched to the shutdown level, the operation of all internal circuits stops, the built-in Pch MOSFET output transistor between VIN pin and VOUT pin is shutdown, allowing current consumption to be drastically reduced. The VOUT pin enters the VSS level due to internally divided resistance of several MΩ between VOUT pin and VSS pin.

Furthermore, the structure of the ON/OFF pin is as shown in **Figure 12**. Since the ON/OFF pin is neither pulled down nor pulled up internally, do not use it in the floating state. In addition, please note that current consumption increases if a voltage of 0.3 V to  $V_{IN}-0.3$  V is applied to the shutdown pin. When the ON/OFF pin is not used, connect it to the VIN pin in case of the product type is "A" and to the VSS pin in case of "B".

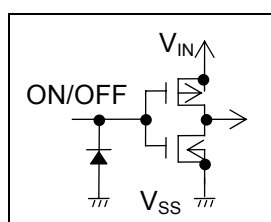

**Figure 12**

**Table 6**

Product type	ON/OFF pin	Internal circuit	VOUT pin voltage	Current consumption
A	"H": Power on	Operating	Set value	$I_{SS1}$
A	"L": Shutdown	Stop	$V_{SS}$ level	$I_{SS2}$
B	"H": Shutdown	Stop	$V_{SS}$ level	$I_{SS2}$
B	"L": Power on	Operating	Set value	$I_{SS1}$

### 4. Short-circuit protection circuit

The S-814 Series incorporates a short-circuit protection circuit to protect the output transistor against short-circuiting between VOUT pin and VSS pin.

The short-circuit protection circuit controls output current as shown in "1. Output voltage vs. Output current (When load current increases)" curve in "■ Characteristics", and prevents output current of approx. 70 mA or more from flowing even if VOUT pin and VSS pin are shorted. However, the short-circuit protection circuit does not protect thermal shutdown. Be sure that input voltage and load current do not exceed the specified power dissipation level.

When output current is large and a difference between input and output voltages is large even if not shorted, the short-circuit protection circuit may start functioning and the output current may be controlled to the specified amperage. For details, refer to "3. Maximum output current vs. Input voltage" curve in "■ Characteristics".

## LOW DROPOUT CMOS VOLTAGE REGULATOR

### S-814 Series

Rev.1.7\_00

#### ■ Selection of Output Capacitor ( $C_L$ )

Mount an output capacitor between VOUT pin and VSS pin for phase compensation. The S-814 Series enables customers to use a ceramic capacitor as well as a tantalum or an aluminum electrolytic capacitor.

- A ceramic capacitor or an OS capacitor:  
Use a capacitor of 0.47  $\mu$ F or more.
- A tantalum or an aluminum electrolytic capacitor:  
Use a capacitor of 0.47  $\mu$ F or more and ESR of 10  $\Omega$  or less.

Pay special attention not to cause an oscillation due to an increase in ESR at low temperatures, when you use the aluminum electrolytic capacitor. Evaluate the capacitor taking into consideration its performance including temperature characteristics.

Overshoot and undershoot characteristics differ depending upon the type of the output capacitor you select. Refer to " **$C_L$  dependencies of overshoot**" and " **$C_L$  dependencies of undershoot**" in "**■ Transient Response Characteristics**".

#### ■ Precautions

- Wiring patterns for VIN pin, VOUT pin and GND pin should be designed so that the impedance is low. When mounting an output capacitor, the distance from the capacitor to the VOUT pin and the VSS pin should be as short as possible.
- Note that output voltage may increase when a series regulator is used at low load current (Less than 10  $\mu$ A).
- Generally, a series regulator may cause oscillation, depending on the selection of external parts. The following conditions are recommended for this IC. However, be sure to perform sufficient evaluation under the actual usage conditions to select the series regulator.
 

Output capacitor ( $C_L$ ):	0.47 $\mu$ F or more
Equivalent Series Resistance (ESR):	10 $\Omega$ or less
Input series resistance ( $R_{IN}$ ):	10 $\Omega$ or less
- The voltage regulator may oscillate when the impedance of the power supply is high and the input capacitor is small or an input capacitor is not connected.
- The application conditions for input voltage and load current do not exceed the power dissipation level of the package.
- In determining the output current, attention should be paid to the output current value specified and footnote \*3 in **Table 5** in the "**■ Electrical Characteristics**".
- Do not apply an electrostatic discharge to this IC that exceeds the performance ratings of the built-in electrostatic protection circuit.
- SII claims no responsibility for any and all disputes arising out of or in connection with any infringement by products including this IC of patents owned by a third party.

■ Characteristics (Typical data)

1. Output voltage ( $V_{OUT}$ ) vs. Output current ( $I_{OUT}$ ) (When load current increases)

S-814A20A

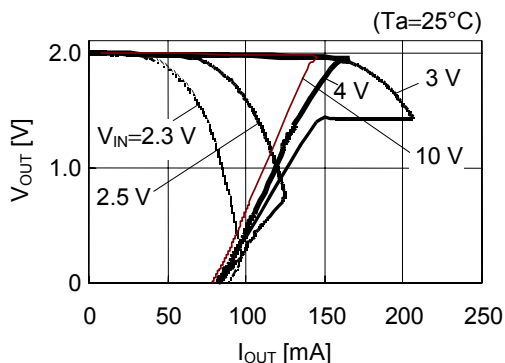

S-814A30A

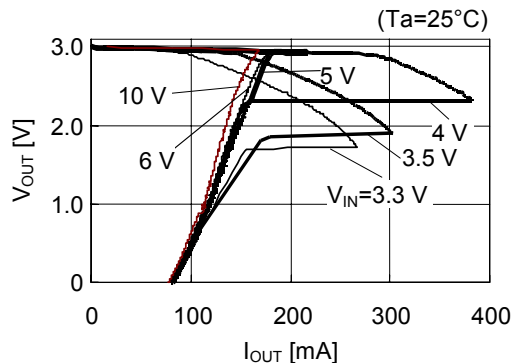

S-814A50A

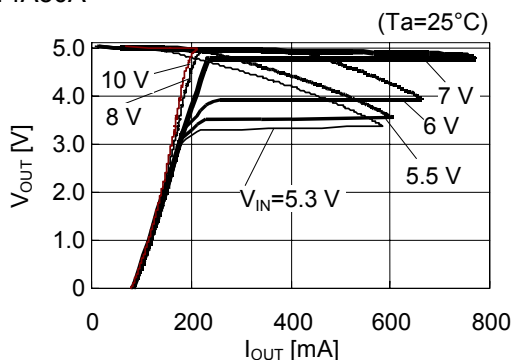

**Remark** In determining the output current, attention should be paid to the following.

1. The minimum output current value and footnote \*3 in Table 5 in the "■ Electrical characteristics".
2. The package power dissipation.

2. Output voltage ( $V_{OUT}$ ) vs. Input voltage ( $V_{IN}$ )

S-814A20A ( $T_a = 25^\circ\text{C}$ )

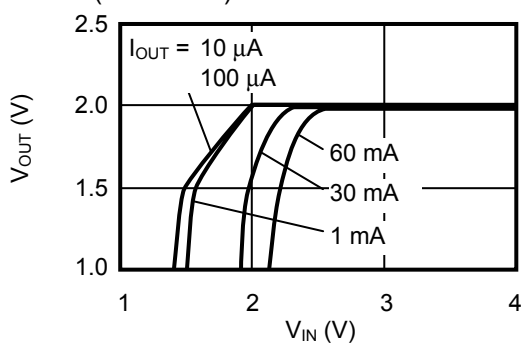

S-814A30A ( $T_a = 25^\circ\text{C}$ )

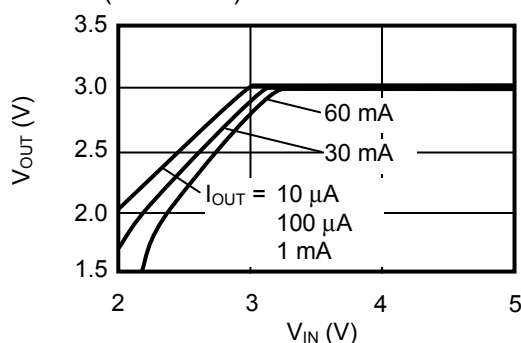

S-814A50A ( $T_a = 25^\circ\text{C}$ )

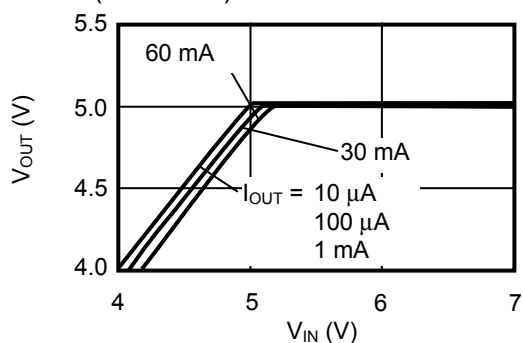

## LOW DROPOUT CMOS VOLTAGE REGULATOR S-814 Series

Rev.1.7\_00

### 3. Maximum output current ( $I_{OUTmax}$ ) vs. Input voltage ( $V_{IN}$ )

S-814A20A

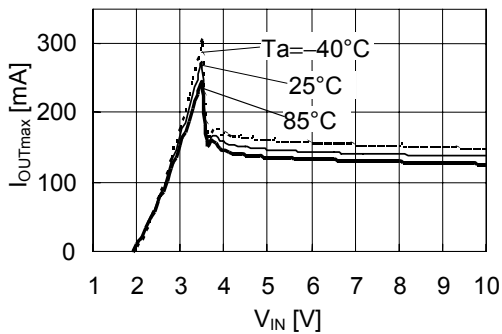

S-814A30A

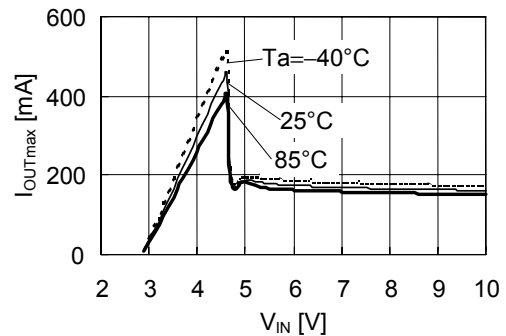

S-814A50A

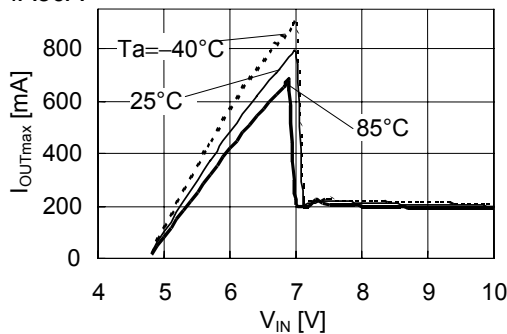

**Remark** In determining the output current, attention should be paid to the following.

1. The minimum output current value and footnote \*3 in **Table 5** in the “**Electrical characteristics**”.
2. The package power dissipation.

### 4. Dropout voltage ( $V_{drop}$ ) vs. Output current ( $I_{OUT}$ )

S-814A20A

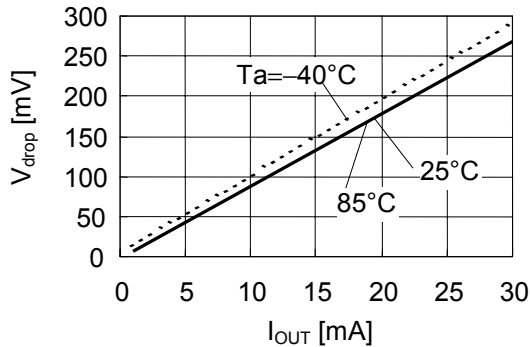

S-814A30A

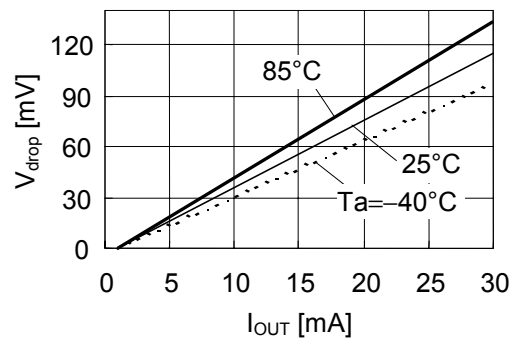

S-814A50A

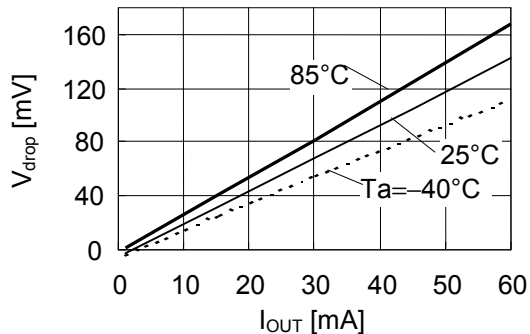



Rev.1.7\_00

### 5. Output voltage ( $V_{OUT}$ ) vs. Ambient temperature ( $T_a$ )

S-814A20A

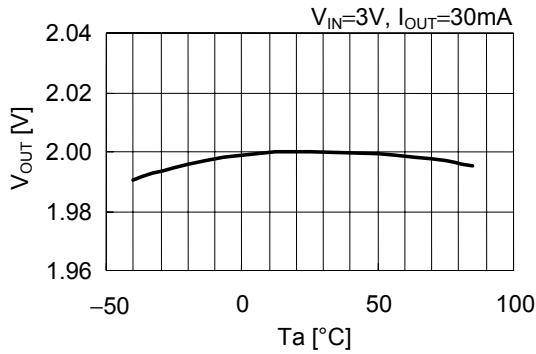

S-814A30A

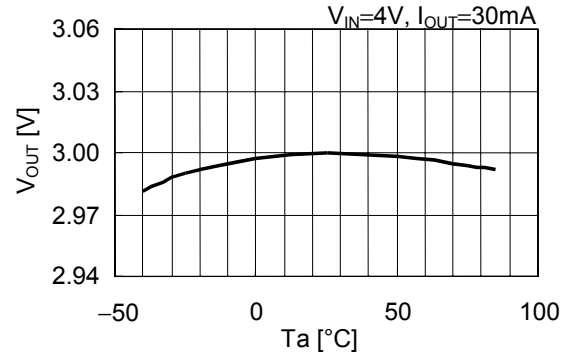

S-814A50A

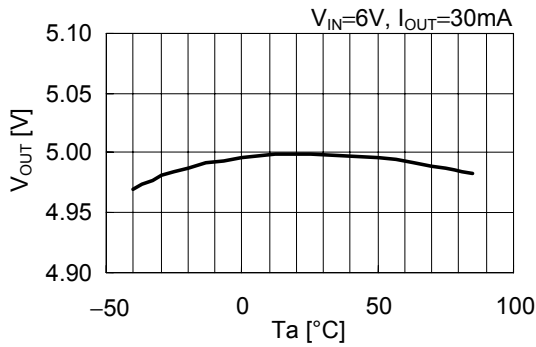

### 6. Line regulation ( $\Delta V_{OUT1}$ ) vs. Ambient temperature ( $T_a$ )

S-814A20A/S-814A30A/S-814A50A

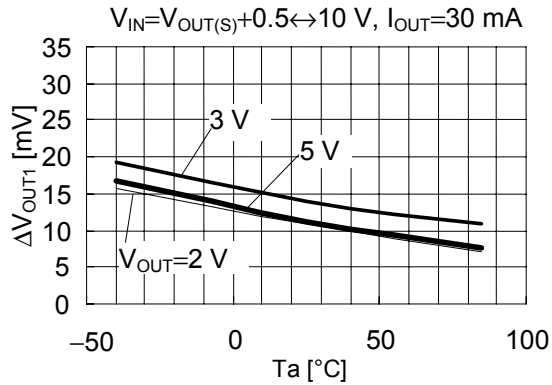

## LOW DROPOUT CMOS VOLTAGE REGULATOR S-814 Series

Rev.1.7\_00

### 7. Load regulation ( $\Delta V_{OUT3}$ ) vs. Ambient temperature ( $T_a$ )

S-814A20A/S-814A30A/S-814A50A

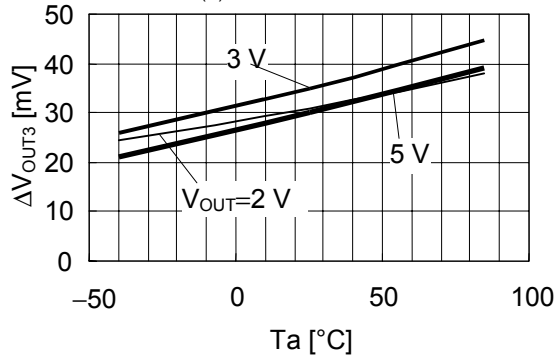
 $V_{IN}=V_{OUT(S)}+1\text{ V}$ ,  $I_{OUT}=10\text{ }\mu\text{A}\leftrightarrow 80\text{ mA}$ 

### 8. Current consumption ( $\Delta I_{SS1}$ ) vs. Input voltage ( $V_{IN}$ )

S-814A20A

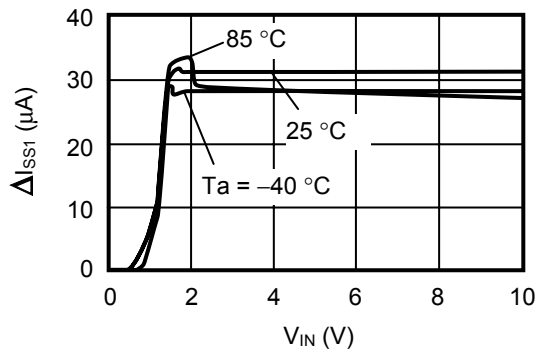

S-814A30A

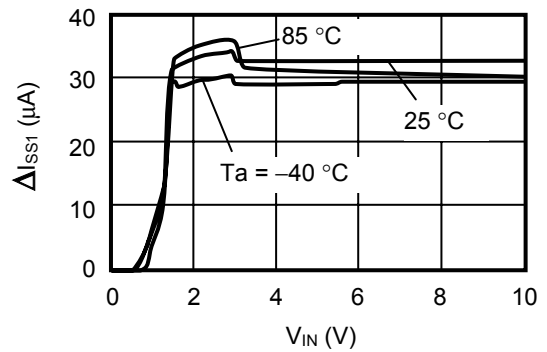

S-814A50A

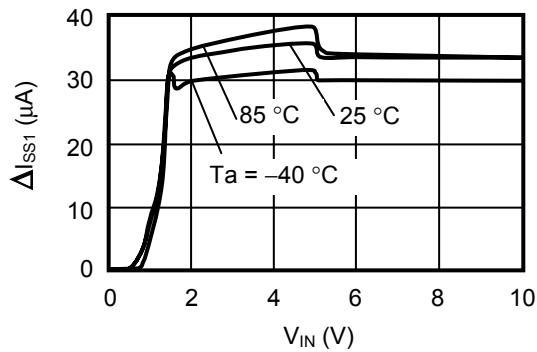

Rev.1.7\_00

**9. Threshold voltage of shutdown pin ( $V_{SH}/V_{SL}$ ) vs. Input voltage ( $V_{IN}$ )**

S-814A20A

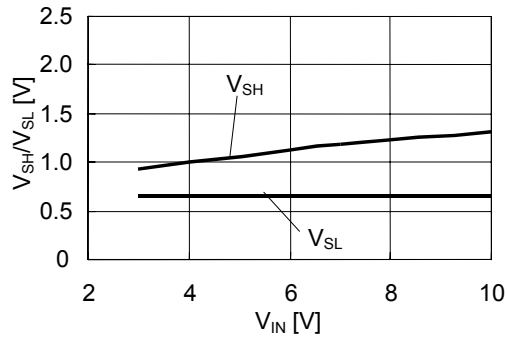

S-814A30A

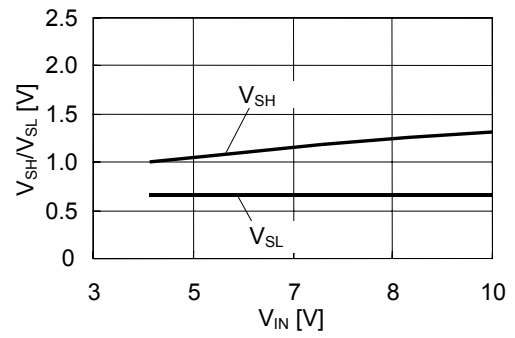

S-814A50A

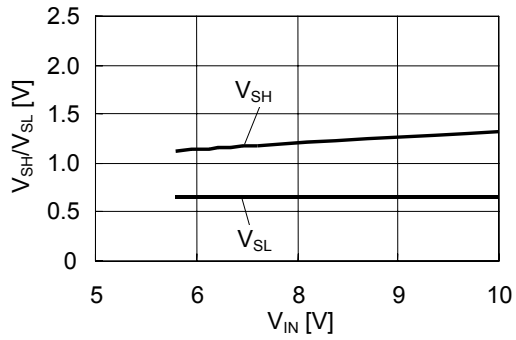

# LOW DROPOUT CMOS VOLTAGE REGULATOR

## S-814 Series

Rev.1.7\_00

### Reference Data

#### 1. Transient Response Characteristics (S-814A30A, Typical data, $T_a=25^\circ\text{C}$ )

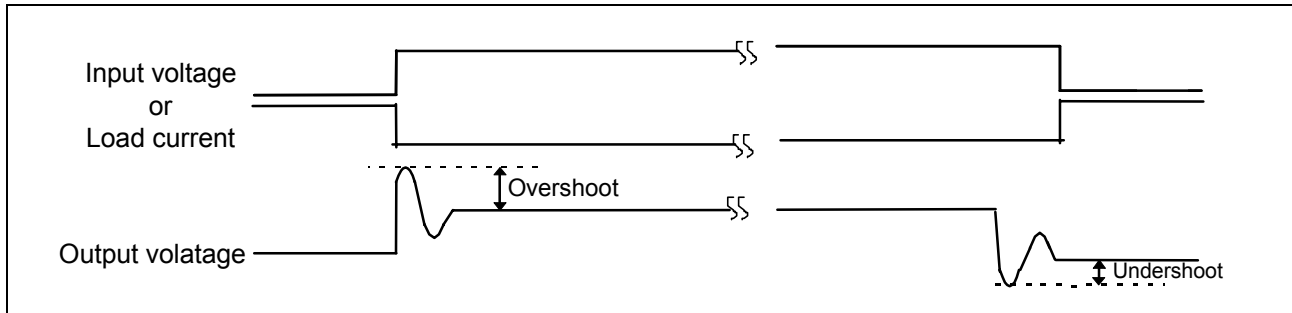

##### 1-1. At power on

Output voltage ( $V_{\text{OUT}}$ ) – Time ( $t$ )

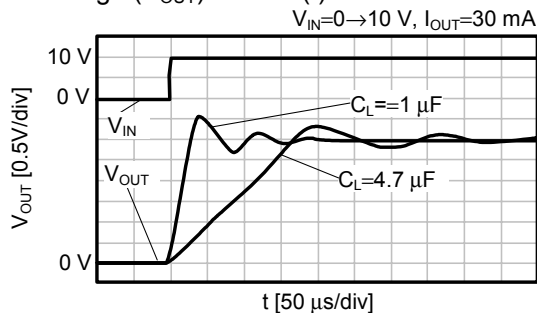

Load dependencies of overshoot

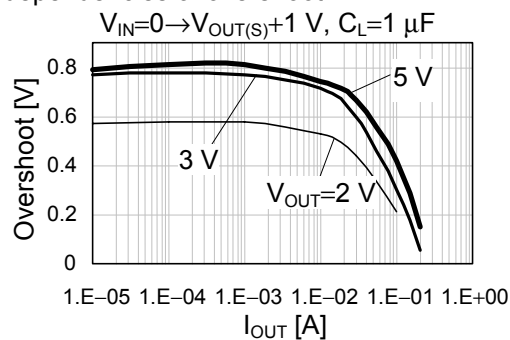

$C_L$  dependencies of overshoot

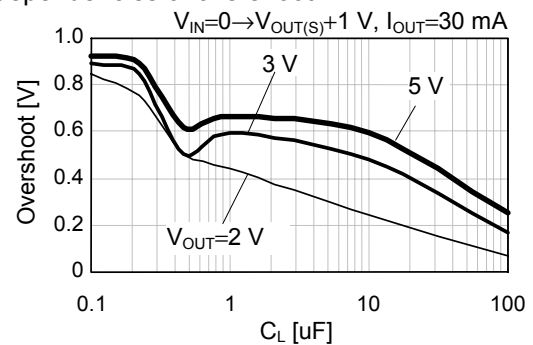

$V_{\text{DD}}$  dependencies of overshoot

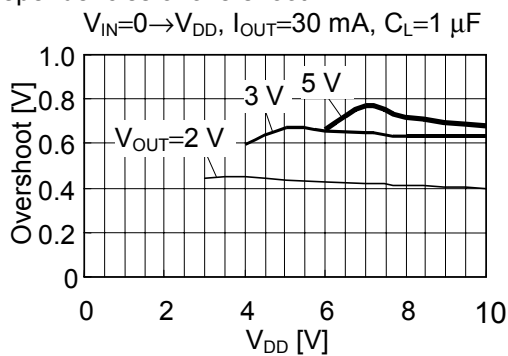

Temperature dependencies of overshoot

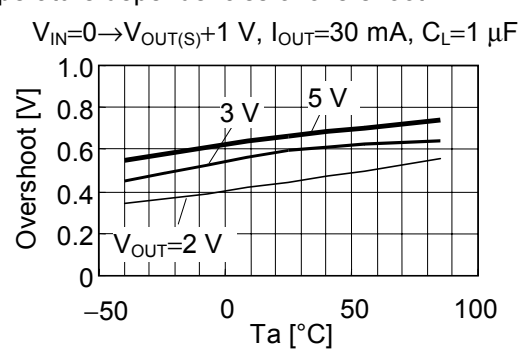

1-2. At power on/off control

Output voltage ( $V_{OUT}$ ) – Time (t)

$V_{IN}=10\text{ V}$ , ON/OFF=0→10 V,  $I_{OUT}=30\text{ mA}$

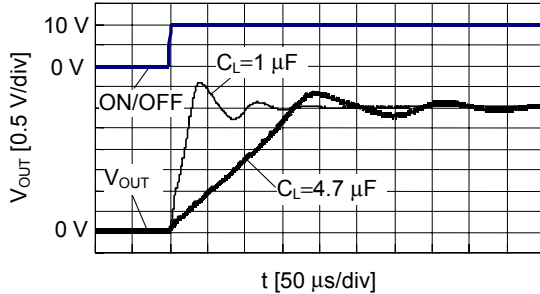

Load dependencies of overshoot

$V_{IN}=V_{OUT(S)}+1\text{ V}$ ,  $C_L=1\text{ μF}$ , ON/OFF=0→ $V_{OUT(S)}+1\text{ V}$

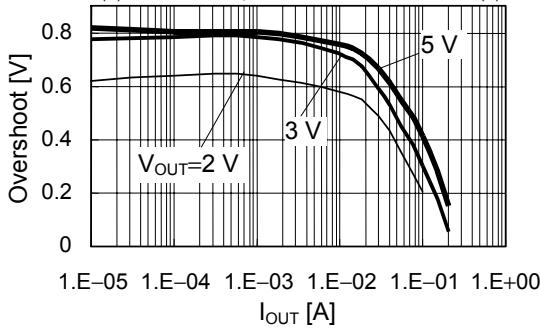

$C_L$  dependencies of overshoot

$V_{IN}=V_{OUT(S)}+1\text{ V}$ ,  $I_{OUT}=30\text{ mA}$ , ON/OFF=0→ $V_{OUT(S)}+1\text{ V}$

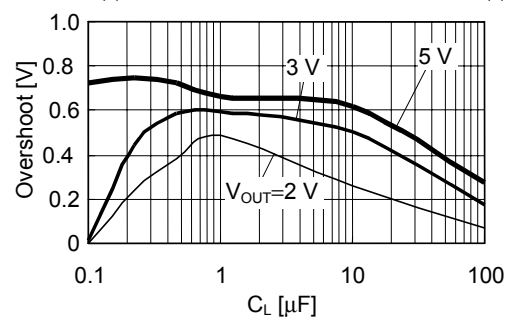

$V_{DD}$  dependencies of overshoot

$V_{IN}=V_{DD}$ ,  $I_{OUT}=30\text{ mA}$ ,  $C_L=1\text{ μF}$ , ON/OFF=0→ $V_{DD}$

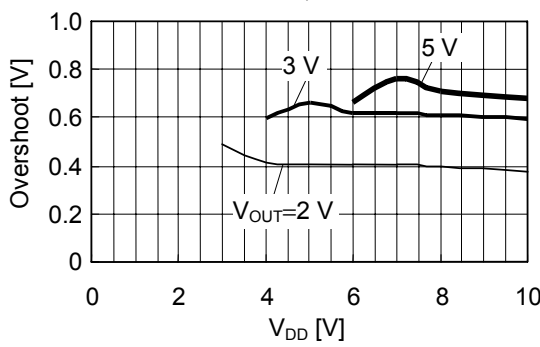

Temperature dependencies of overshoot

$V_{IN}=V_{OUT(S)}+1\text{ V}$ ,  $I_{OUT}=30\text{ mA}$ ,  $C_L=1\text{ μF}$ , ON/OFF=0→ $V_{OUT(S)}+1\text{ V}$

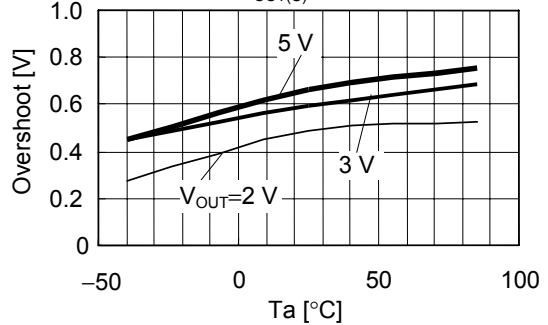

# LOW DROPOUT CMOS VOLTAGE REGULATOR

## S-814 Series

### 1-3. At power fluctuation

Output voltage ( $V_{OUT}$ ) – Time ( $t$ )

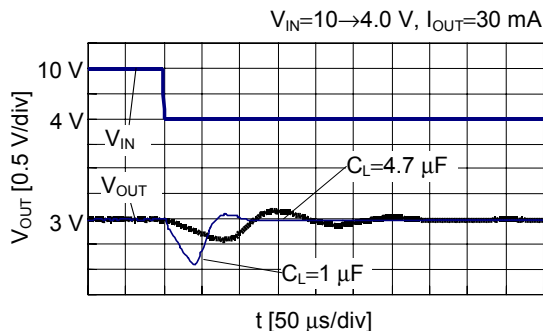
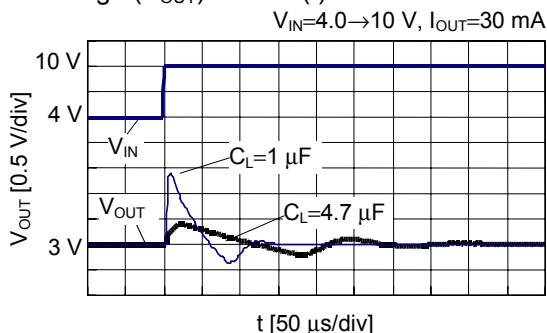

Load dependencies of overshoot

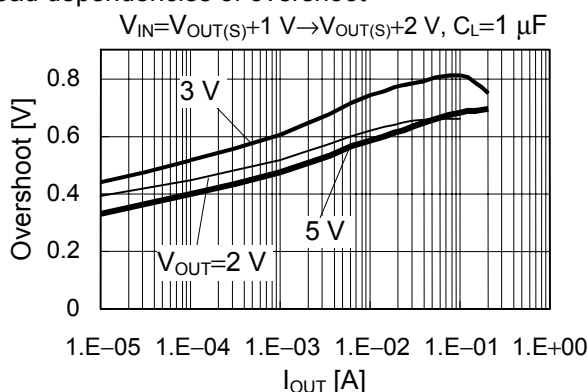

$C_L$  dependencies of overshoot

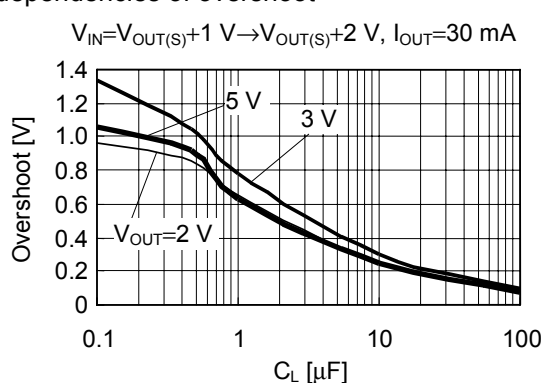

$V_{DD}$  dependencies of overshoot

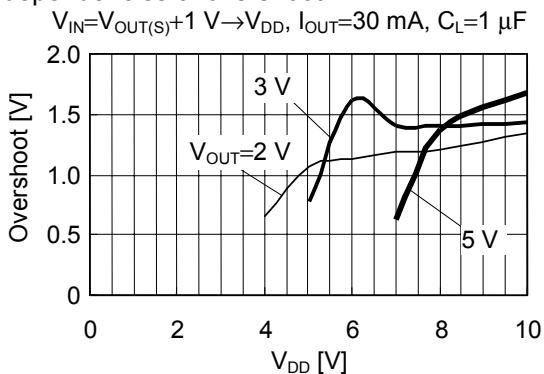

Temperature dependencies of overshoot

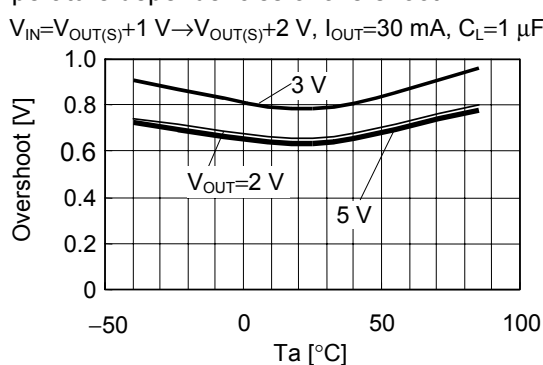

Load dependencies of undershoot

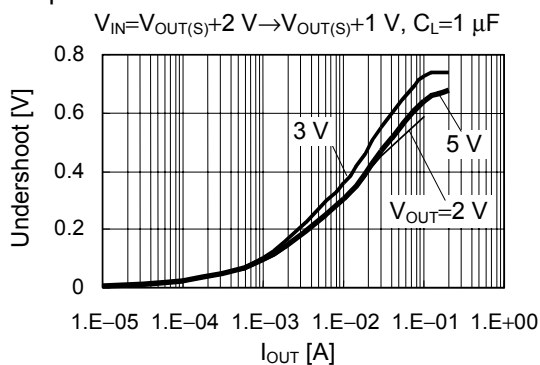

$C_L$  dependencies of undershoot

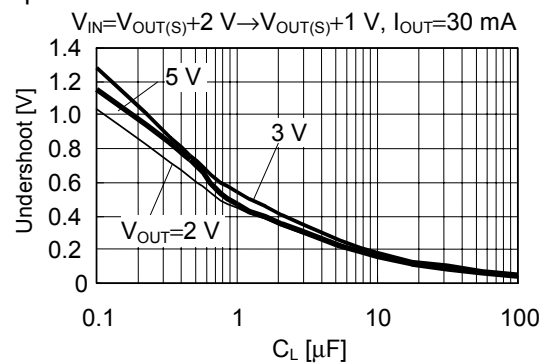

# LOW DROPOUT CMOS VOLTAGE REGULATOR S-814 Series

Rev.1.7\_00

### $V_{DD}$ dependencies of undershoot

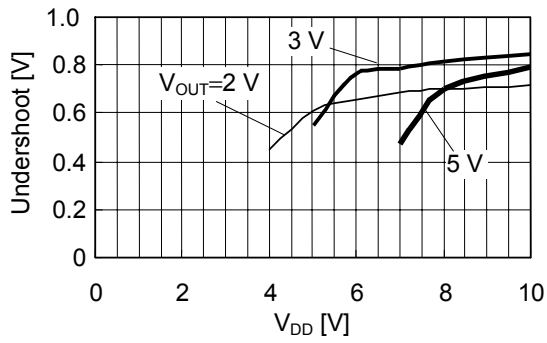
 $V_{IN}=V_{DD} \rightarrow V_{OUT(S)}+1 \text{ V}, I_{OUT}=30 \text{ mA}, C_L=1 \mu\text{F}$ 

### Temperature dependencies of undershoot

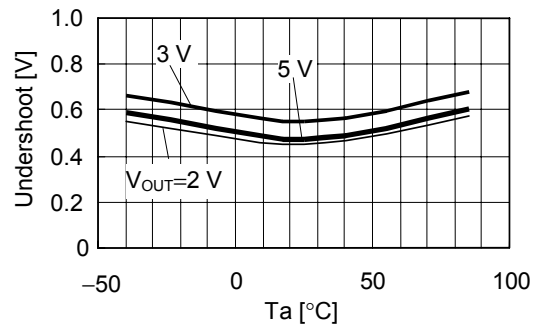
 $V_{IN}=V_{OUT(S)}+2 \text{ V} \rightarrow V_{OUT(S)}+1 \text{ V}, I_{OUT}=30 \text{ mA}, C_L=1 \mu\text{F}$ 

# LOW DROPOUT CMOS VOLTAGE REGULATOR S-814 Series

## 1-4. At load fluctuation

Output voltage ( $V_{OUT}$ ) – Time ( $t$ )

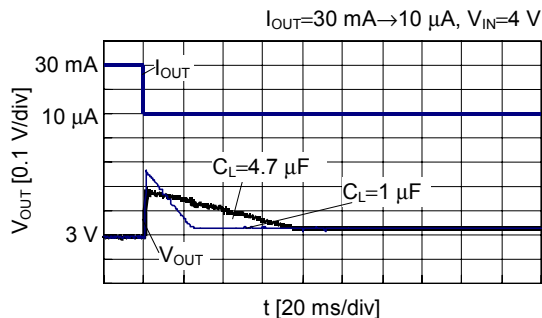
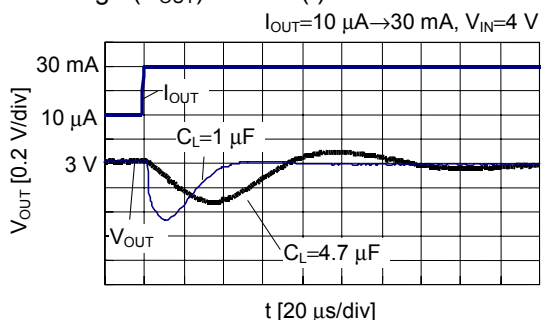

Load current dependencies of overshoot

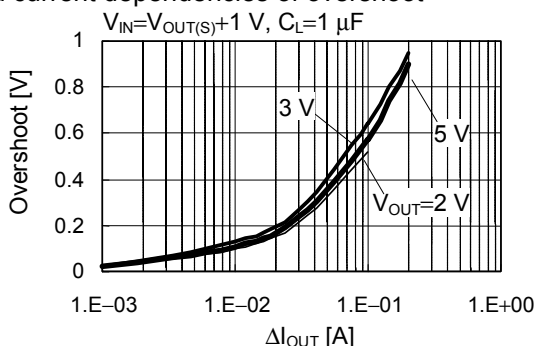

$C_L$  dependencies of overshoot

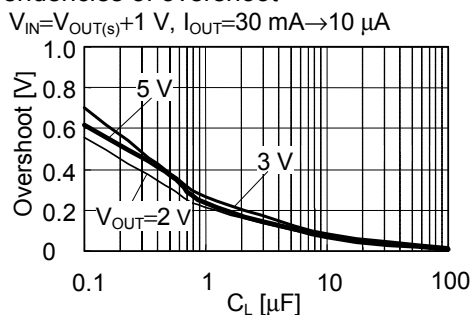

**Remark**  $\Delta I_{OUT}$  shows larger load current at load current fluctuation. Smaller current at load current fluctuation is fixed to 10  $\mu A$ .  
i.e.  $\Delta I_{OUT}=1.E-02 [A]$  means load current fluctuation from 10 mA to 10  $\mu A$ .

$V_{DD}$  dependencies of overshoot

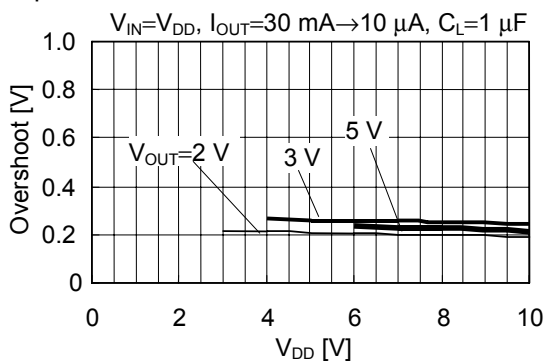

Temperature dependencies of overshoot

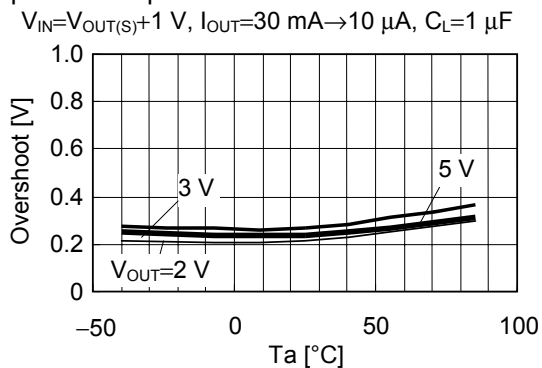



Rev.1.7\_00

Load current dependencies of undershoot

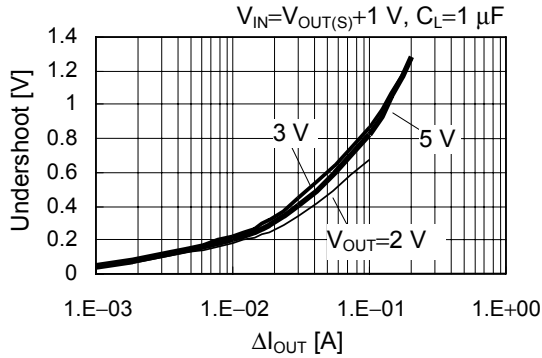

$C_L$  dependence of undershoot

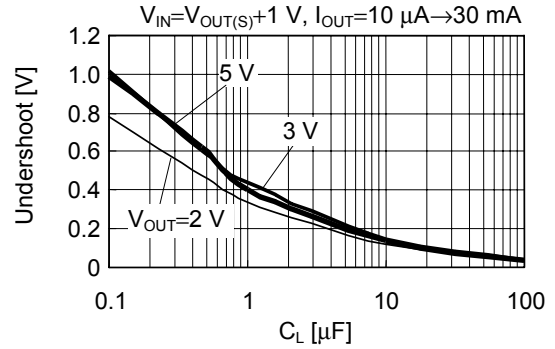

**Remark**  $\Delta I_{OUT}$  shows larger load current at load current fluctuation. Lower current at load current fluctuation is fixed to 10  $\mu\text{A}$ .  
i.e.  $\Delta I_{OUT}=1.E-02$  [A] means load current fluctuation from 10  $\mu\text{A}$  to 10 mA.

$V_{DD}$  dependencies of undershoot

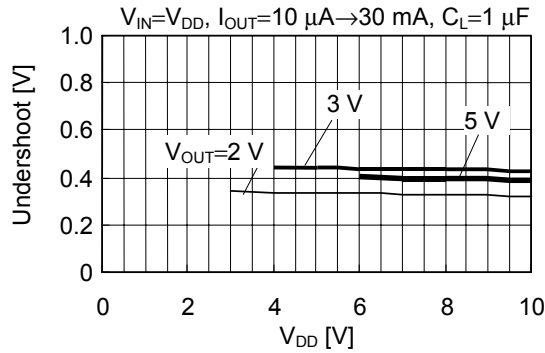

Temperature dependencies of undershoot

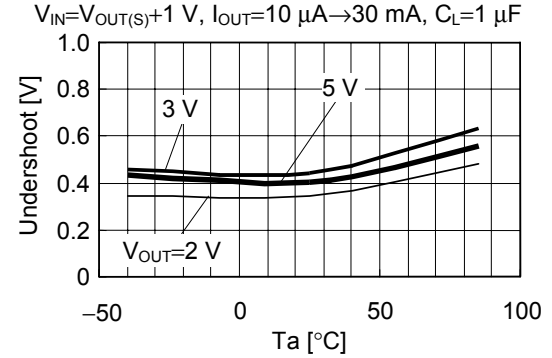

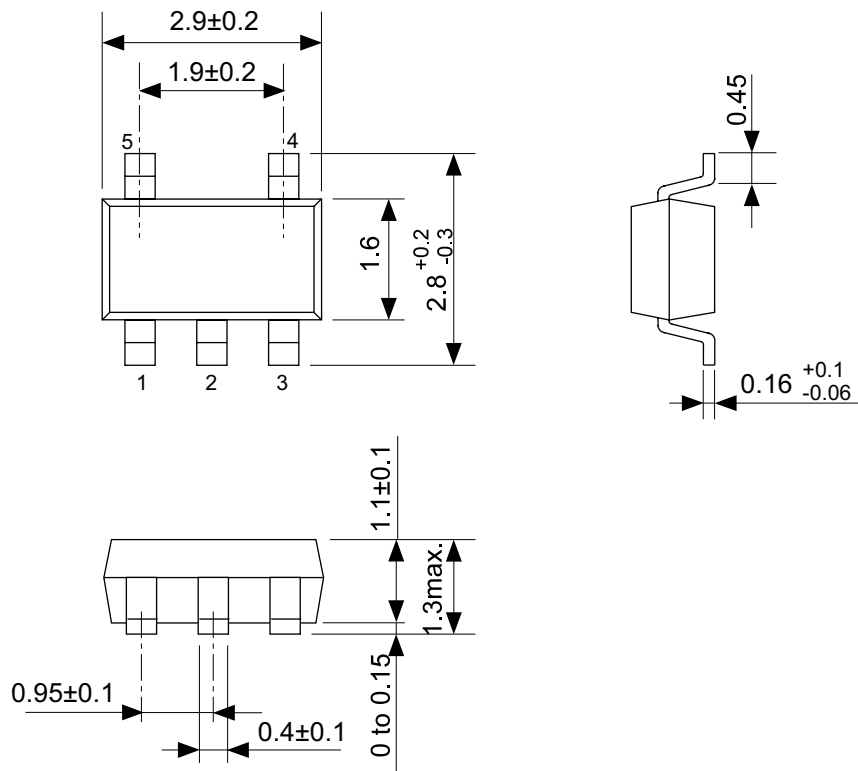

No. MP005-A-P-SD-1.2

TITLE	SOT235-A-PKG Dimensions
No.	MP005-A-P-SD-1.2
SCALE	
UNIT	mm
www.DataSheet4U.com	
Seiko Instruments Inc.	

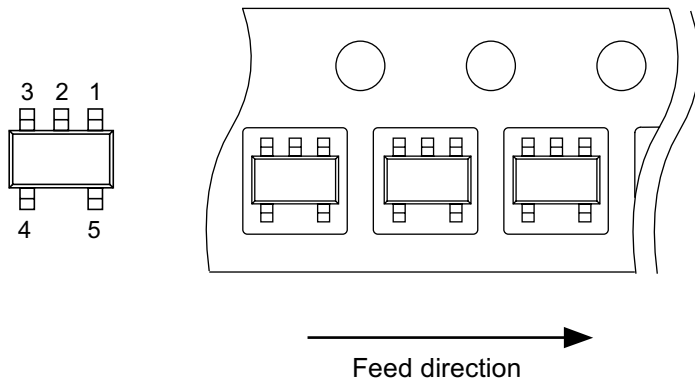
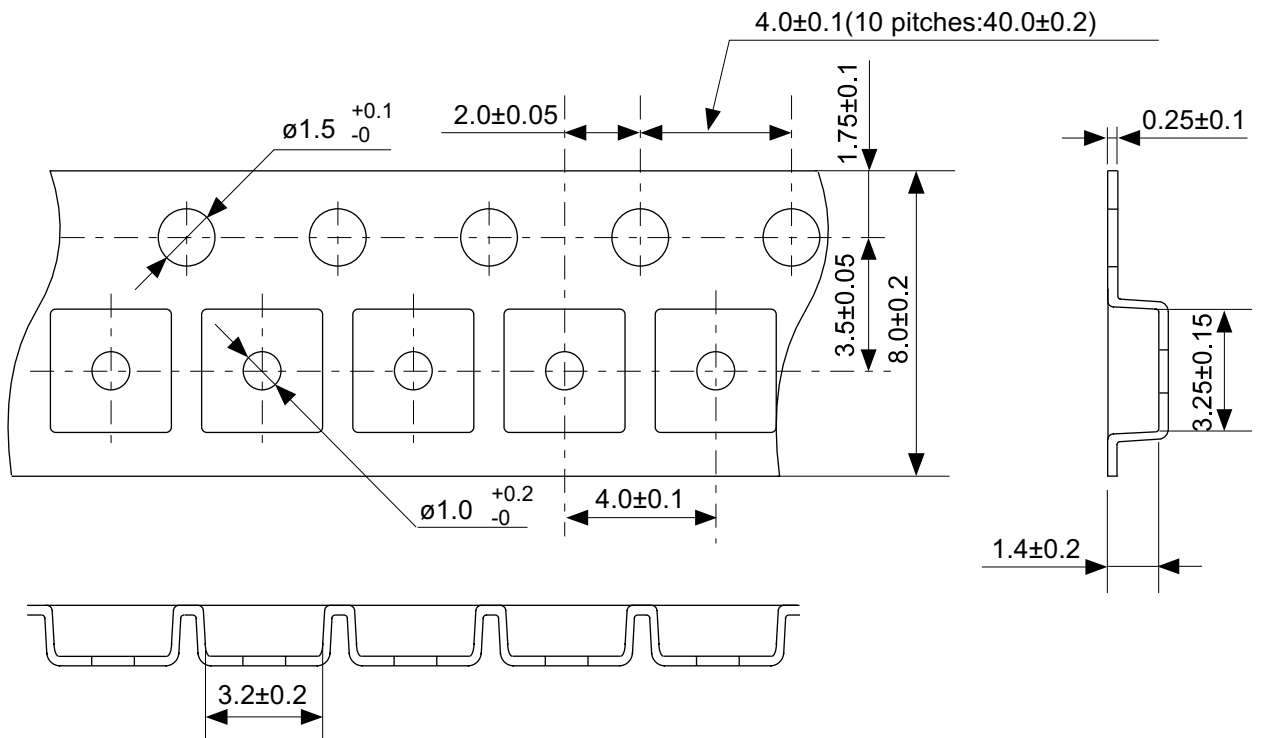

No. MP005-A-C-SD-2.1

TITLE	SOT235-A-Carrier Tape
No.	MP005-A-C-SD-2.1
SCALE	
UNIT	mm
Seiko Instruments Inc.	

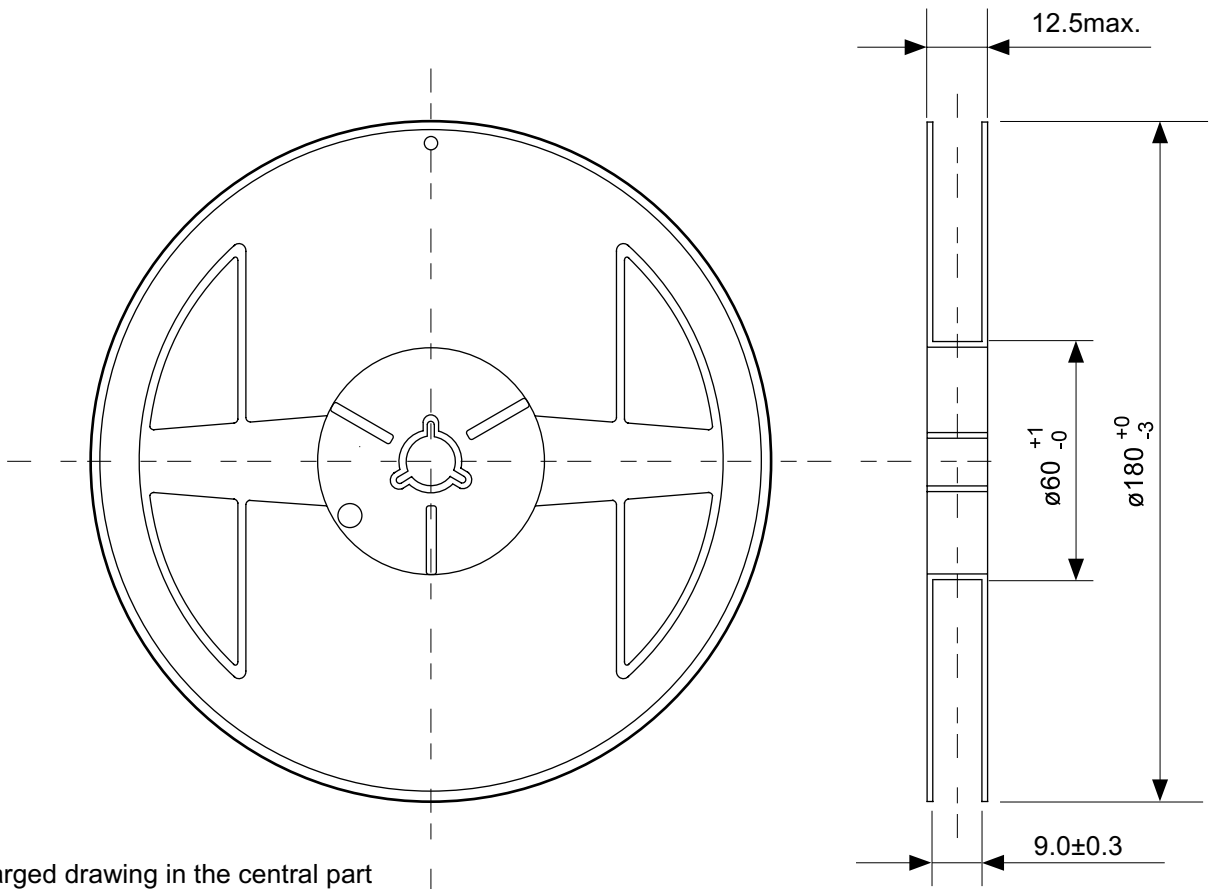

Enlarged drawing in the central part

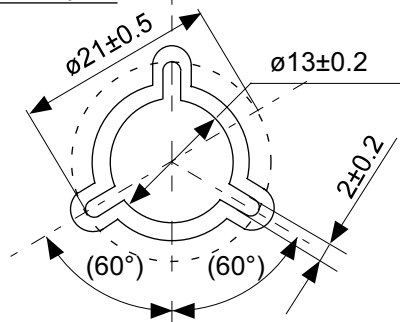

No. MP005-A-R-SD-1.1

TITLE	SOT235-A-Reel		
No.	MP005-A-R-SD-1.1		
SCALE		QTY.	3,000
UNIT	mm		
	www.DataSheet4U.com		
	Seiko Instruments Inc.		

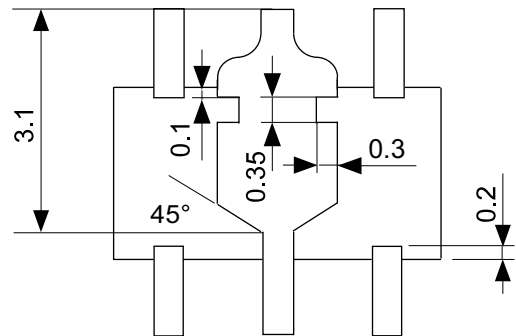
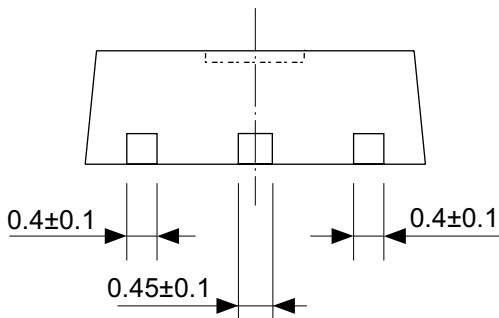
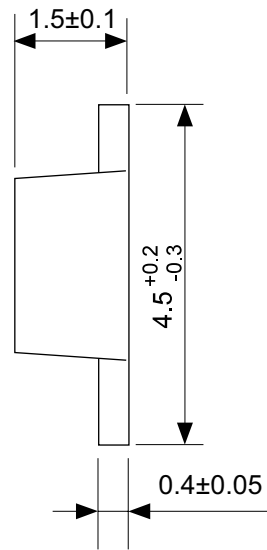
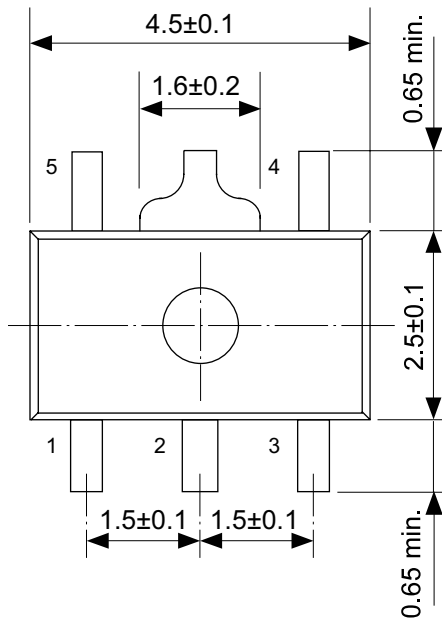

No. UP005-A-P-SD-1.1

TITLE	SOT895-A-PKG Dimensions
No.	UP005-A-P-SD-1.1
SCALE	
UNIT	mm
www.DataSheet4U.com	
Seiko Instruments Inc.	

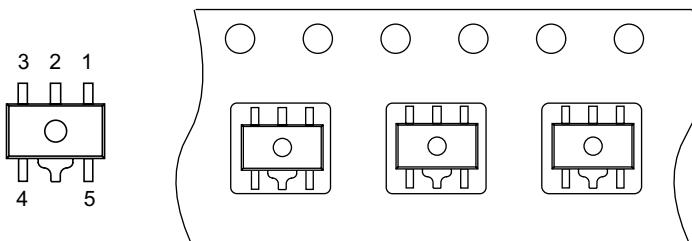
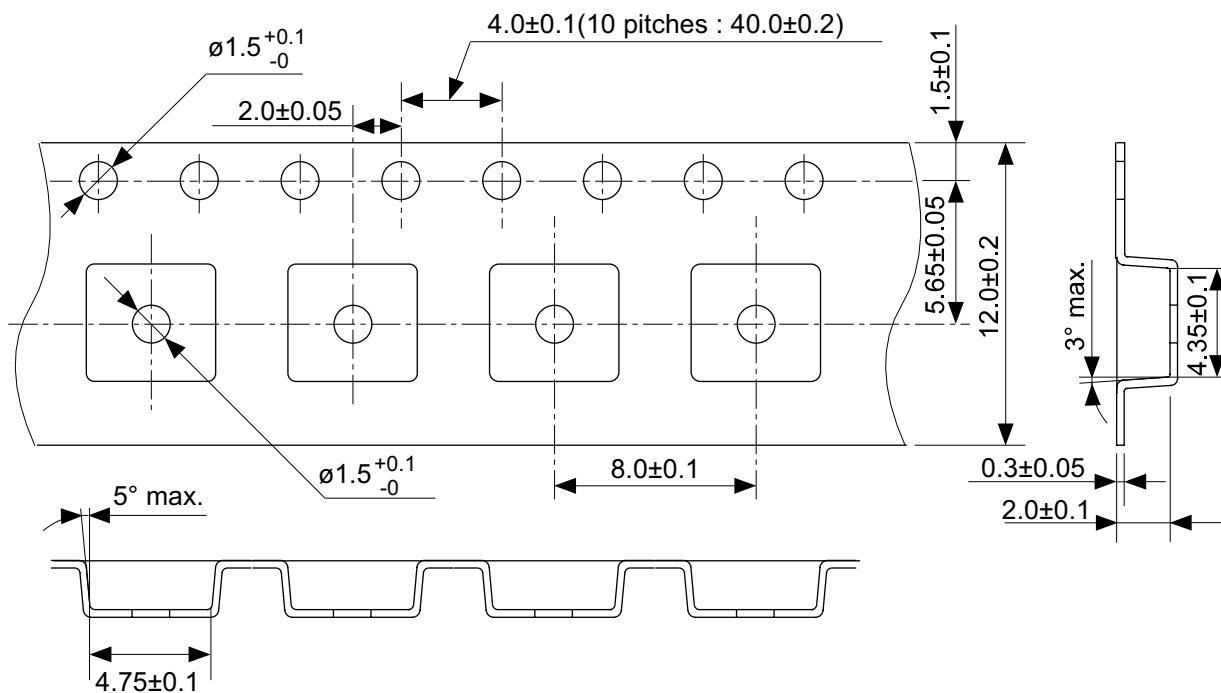

→  
Feed direction

No. UP005-A-C-SD-1.1

TITLE	SOT895-A-Carrier Tape
No.	UP005-A-C-SD-1.1
SCALE	
UNIT	mm
Seiko Instruments Inc.	

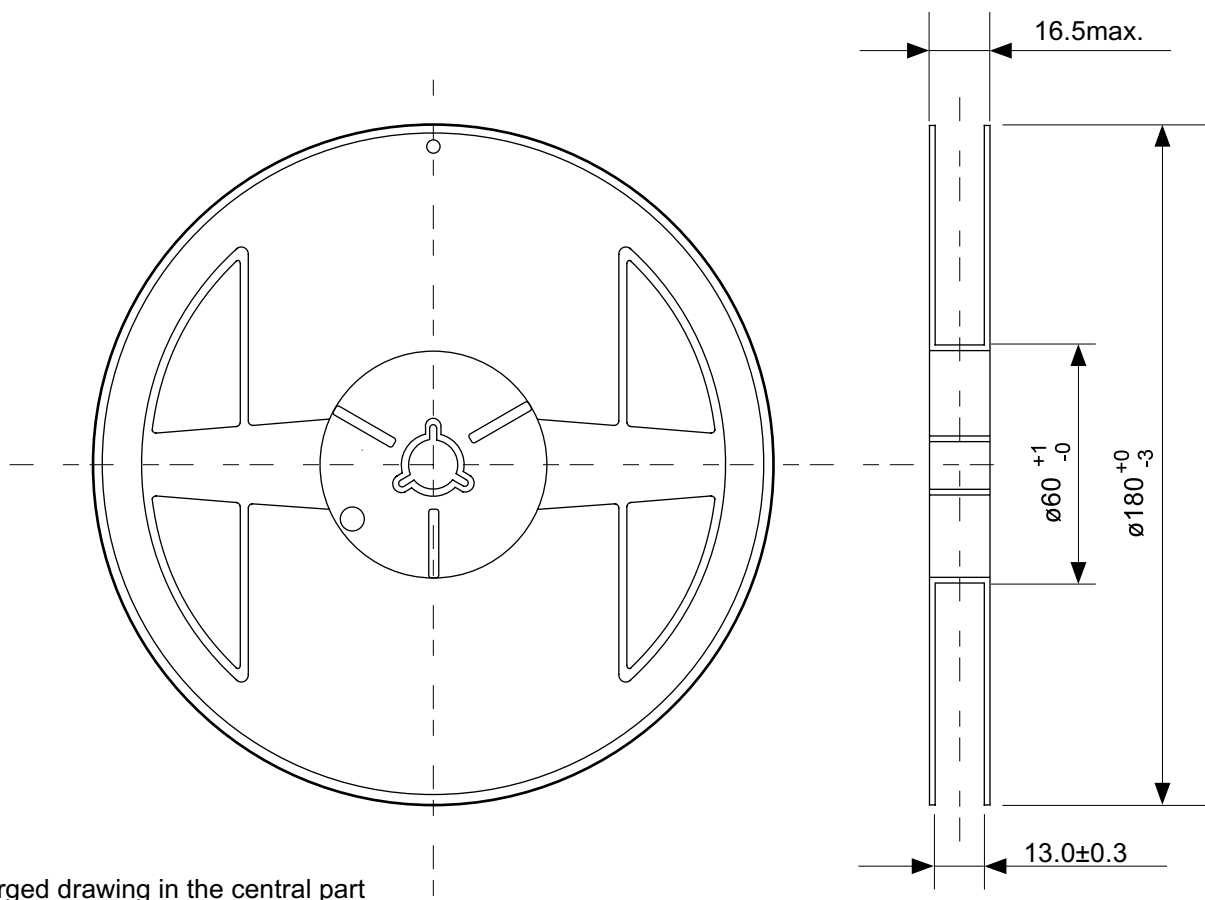

Enlarged drawing in the central part

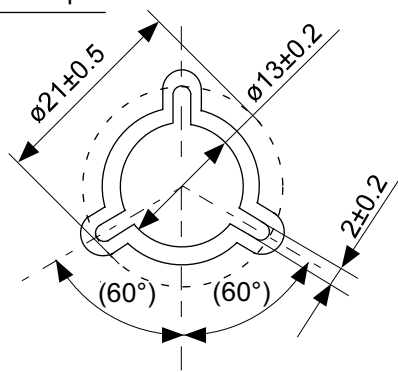

No. UP005-A-R-SD-1.1

TITLE	SOT895-A-Reel		
No.	UP005-A-R-SD-1.1		
SCALE		QTY.	1,000
UNIT	mm		
	www.DataSheet4U.com		
Seiko Instruments Inc.			

- The information described herein is subject to change without notice.
- Seiko Instruments Inc. is not responsible for any problems caused by circuits or diagrams described herein whose related industrial properties, patents, or other rights belong to third parties. The application circuit examples explain typical applications of the products, and do not guarantee the success of any specific mass-production design.
- When the products described herein are regulated products subject to the Wassenaar Arrangement or other agreements, they may not be exported without authorization from the appropriate governmental authority.
- Use of the information described herein for other purposes and/or reproduction or copying without the express permission of Seiko Instruments Inc. is strictly prohibited.
- The products described herein cannot be used as part of any device or equipment affecting the human body, such as exercise equipment, medical equipment, security systems, gas equipment, or any apparatus installed in airplanes and other vehicles, without prior written permission of Seiko Instruments Inc.
- Although Seiko Instruments Inc. exerts the greatest possible effort to ensure high quality and reliability, the failure or malfunction of semiconductor products may occur. The user of these products should therefore give thorough consideration to safety design, including redundancy, fire-prevention measures, and malfunction prevention, to prevent any accidents, fires, or community damage that may ensue.