

The S-8255A Series is a monitoring IC for 3-serial to 5-serial cell lithium-ion rechargeable batteries, which includes high-accuracy voltage detection circuits and delay circuits. The S-8255A Series can monitor the status of 3-serial to 5-serial cell lithium-ion rechargeable battery packs. Cascade connection using the S-8255A Series realizes monitoring 6-serial or more cells lithium-ion rechargeable battery packs.

Connecting an NTC, it allows for the temperature detection at four different points: high temperature detection during charging, low temperature detection during charging, high temperature detection during discharging, and low temperature detection during discharging.

■ Features

- High-accuracy voltage detection function for each cell

Overcharge detection voltage n (n = 1 to 5):	3.550 V to 4.600 V (50 mV step)	Accuracy ±20 mV
Overcharge release voltage n (n = 1 to 5):	3.150 V to 4.600 V ^{*1}	Accuracy ±50 mV
Overdischarge detection voltage n (n = 1 to 5):	2.000 V to 3.200 V (100 mV step)	Accuracy ±80 mV
Overdischarge release voltage n (n = 1 to 5):	2.000 V to 3.400 V ^{*2}	Accuracy ±100 mV
- Each delay time is settable by external capacitor (Temperature detection delay time is internally fixed)
- Independent control of charge inhibition, discharge inhibition, and power-saving by each control pin
- 0 V battery detection function is selectable: Available, unavailable
- CO and DO pin output voltage is limited to 8 V max. respectively
- Switching control for 3-serial to 5-serial cell is possible by inputting voltage to the SEL1 pin and the SEL2 pin
- Monitoring of 6-serial or more cells is possible by cascade connection
- Temperature detection is possible at four different points by connecting an NTC

High temperature detection ratio during charging / discharging:	0.600 to 0.900 (0.005 step)	Accuracy ±0.005
Low temperature detection ratio during charging / discharging:	0.030 to 0.400 (0.005 step)	Accuracy ±0.005
- High-withstand voltage: Absolute maximum rating 28 V
- Wide operation voltage range: 5 V to 24 V
- Wide operation temperature range: Ta = -40°C to +85°C
- Low current consumption

During operation:	19 μA max. (Ta = +25°C)
During power-saving:	0.1 μA max. (Ta = +25°C)
- Lead-free, halogen-free

*1. Overcharge release voltage = Overcharge detection voltage – Overcharge hysteresis voltage
(Overcharge hysteresis voltage n (n = 1 to 5) is selectable in 0 V to 0.4 V in 50 mV step)

*2. Overdischarge release voltage = Overdischarge detection voltage + Overdischarge hysteresis voltage
(Overdischarge hysteresis voltage n (n = 1 to 5) is selectable in 0 V to 0.7 V in 100 mV step)

■ Application

- Rechargeable lithium-ion battery pack

■ Package

- 20-Pin TSSOP

■ **Block Diagram**

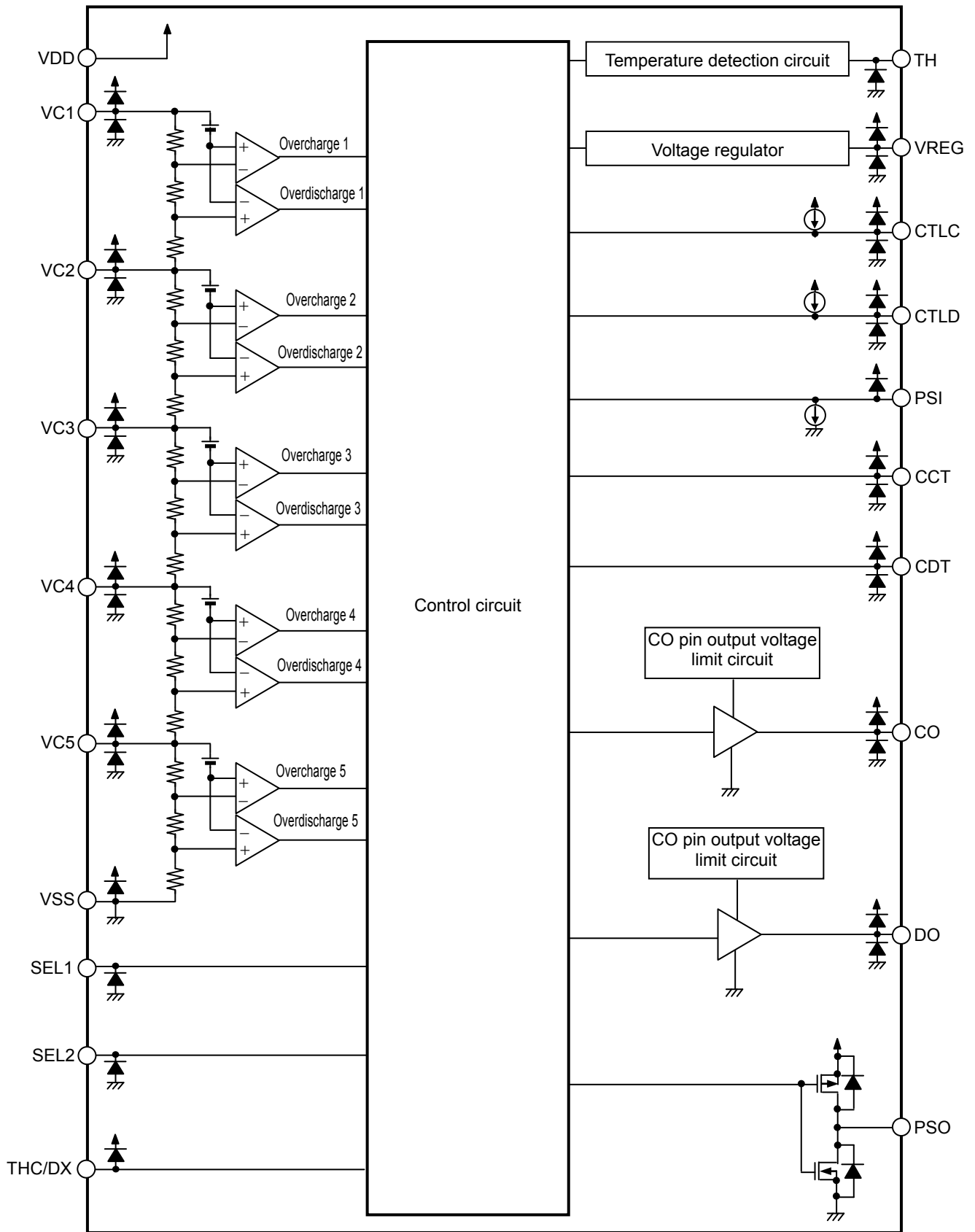

Remark Diodes in the figure are parasitic diodes.

Figure 1
ABLIC Inc.

■ Product Name Structure

1. Product name

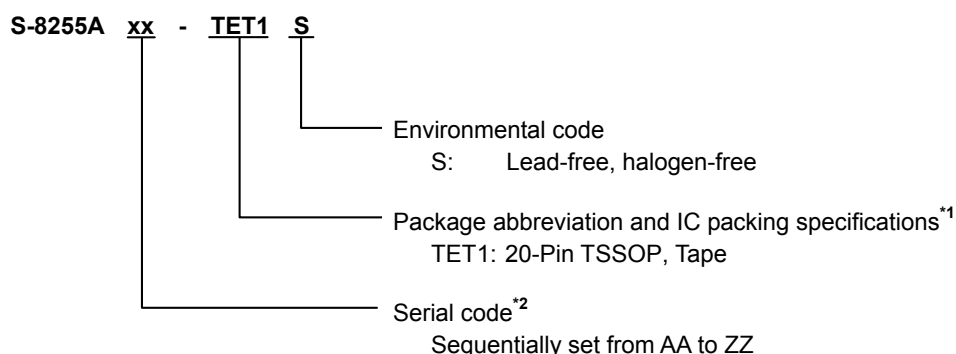

*1. Refer to the tape drawing.

*2. Refer to "3. Product name list".

2. Package

Table 1 Package Drawing Code

Package Name	Dimension	Tape	Reel
20-Pin TSSOP	FT020-B-P-SD	FT020-B-C-SD	FT020-B-R-SD

3. Product name list

Table 2 (1 / 2)

Product Name	Overcharge Detection Voltage [V _{CU}]	Overcharge Release Voltage [V _{CL}]	Overdischarge Detection Voltage [V _{DL}]	Overdischarge Release Voltage [V _{DU}]	0 V Battery Detection Function* ¹
S-8255AAA-TET1S	4.100 V	4.050 V	2.600 V	2.700 V	Unavailable
S-8255AAB-TET1S	4.250 V	4.150 V	2.500 V	3.000 V	Available

Table 2 (2 / 2)

Product Name	High Temperature Detection Ratio during Charging [r _{THCH}]	Low Temperature Detection Ratio during Charging [r _{THCL}]	High Temperature Detection Ratio during Discharging [r _{THDH}]	Low Temperature Detection Ratio during Discharging [r _{THDL}]
S-8255AAA-TET1S	0.670	0.270	0.795	0.190
S-8255AAB-TET1S	0.670	0.270	0.795	0.190

*1. 0 V battery detection function "available" / "unavailable" is selectable.

Remark Please contact our sales office for products other than those specified above.

■ **Pin Configuration**

1. **20-Pin TSSOP**

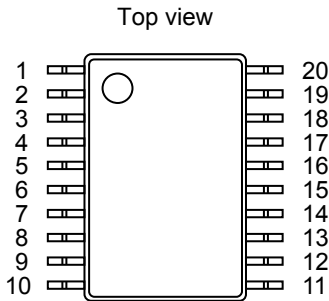

Figure 2

Table 3

Pin No.	Symbol	Description
1	TH	Input pin for temperature detection
2	VDD	Input pin for positive power supply, connection pin for positive voltage of battery 1
3	VC1	Connection pin for positive voltage of battery 1
4	VC2	Connection pin for negative voltage of battery 1, connection pin for positive voltage of battery 2
5	VC3	Connection pin for negative voltage of battery 2, connection pin for positive voltage of battery 3
6	VC4	Connection pin for negative voltage of battery 3, connection pin for positive voltage of battery 4
7	VC5	Connection pin for negative voltage of battery 4, connection pin for positive voltage of battery 5
8	VSS	Input pin for negative power supply, connection pin for negative voltage of battery 5
9	SEL1	Switching pins for number of cells in series [SEL1, SEL2] = ["L", "L"] : 5-serial cell [SEL1, SEL2] = ["L", "H"] : 4-serial cell [SEL1, SEL2] = ["H", "L"] : 3-serial cell [SEL1, SEL2] = ["H", "H"] : Setting inhibited
10	SEL2	
11	CCT	Capacitor connection pin for delay for overcharge detection voltage
12	CDT	Capacitor connection pin for delay for overdischarge detection voltage
13	PSO	Output pin for power-saving signal (CMOS output)
14	DO	Connection pin of discharge control FET gate (CMOS output)
15	CO	Connection pin of charge control FET gate (CMOS output)
16	THC/DX	Switching pin for detection temperature
17	CTLG	Control pin for CO pin output
18	CTLD	Control pin for DO pin output
19	PSI	Control pin for Power-saving
20	VREG	Voltage output pin for temperature detection

■ Absolute Maximum Ratings

Table 4

(Ta = +25°C unless otherwise specified)

Item	Symbol	Applied Pin	Absolute Maximum Rating	Unit
Input voltage between VDD pin and VSS pin	V _{DS}	VDD	V _{SS} - 0.3 to V _{SS} + 28	V
Input pin voltage 1	V _{IN1}	VC1, VC2, VC3, VC4, VC5, CCT, CDT, SEL1, SEL2, TH, THC/DX	V _{SS} - 0.3 to V _{DD} + 0.3	V
Input pin voltage 2	V _{IN2}	PSI	V _{DD} - 28 to V _{DD} + 0.3	V
Input pin voltage 3	V _{IN3}	CTLG, CTLD	V _{SS} - 0.3 to V _{SS} + 28	V
Output pin voltage	V _{OUT}	CO, DO, PSO, VREG	V _{SS} - 0.3 to V _{DD} + 0.3	V
Operation ambient temperature	T _{opr}	-	-40 to +85	°C
Storage temperature	T _{stg}	-	-40 to +125	°C

Caution The absolute maximum ratings are rated values exceeding which the product could suffer physical damage. These values must therefore not be exceeded under any conditions.

■ Thermal Resistance Value

Table 5

Item	Symbol	Condition	Min.	Typ.	Max.	Unit	
Junction-to-ambient thermal resistance*1	θ _{JA}	20-Pin TSSOP	Board A	-	68	-	°C/W
			Board B	-	59	-	°C/W
			Board C	-	-	-	°C/W
			Board D	-	-	-	°C/W
			Board E	-	-	-	°C/W

*1. Test environment: compliance with JEDEC STANDARD JESD51-2A

Remark Refer to "■ Power Dissipation" and "Test Board" for details.

■ **Electrical Characteristics**

Table 6 (1 / 2)

(V1 = V2 = V3 = V4 = V5 = 3.5 V, Ta = +25°C unless otherwise specified)

Item	Symbol	Condition	Min.	Typ.	Max.	Unit	Test Circuit
Detection Voltage							
Overcharge detection voltage n (n = 1 to 5)	V _{CU_n}	V1 = V2 = V3 = V4 = V5 = V _{CU_n} - 0.050 V	V _{CU_n} - 0.020	V _{CU_n}	V _{CU_n} + 0.020	V	1
Overcharge release voltage n (n = 1 to 5)	V _{CL_n}	-	V _{CL_n} - 0.050	V _{CL_n}	V _{CL_n} + 0.050	V	1
Overdischarge detection voltage n (n = 1 to 5)	V _{DL_n}	-	V _{DL_n} - 0.080	V _{DL_n}	V _{DL_n} + 0.080	V	1
Overdischarge release voltage n (n = 1 to 5)	V _{DU_n}	-	V _{DU_n} - 0.100	V _{DU_n}	V _{DU_n} + 0.100	V	1
Delay Time Function*1							
CCT pin internal resistance	R _{CCT}	V1 = V _{CU} + 0.025	6.15	8.31	10.20	MΩ	1
CDT pin internal resistance	R _{CDT}	V1 = V _{DL} - 0.085	615	831	1020	kΩ	1
CCT pin detection voltage	V _{CCT}	V1 = V _{CU} + 0.025	V _{DS} × 0.68	V _{DS} × 0.70	V _{DS} × 0.72	V	1
CDT pin detection voltage	V _{CDT}	V1 = V _{DL} - 0.085	V _{DS} × 0.68	V _{DS} × 0.70	V _{DS} × 0.72	V	1
Input Voltage							
Operation voltage between VDD pin and VSS pin	V _{DSOP}	Fixed output voltage of DO pin and CO pin	5	-	24	V	-
Input Current							
Current consumption during operation	I _{OPE}	-	-	10	19	μA	1
Current consumption during power-saving	I _{PSV}	-	-	-	0.1	μA	1
VC1 pin current	I _{VC1}	-	-	0.25	0.50	μA	1
VC2 pin current	I _{VC2}	-	-0.8	0.0	0.8	μA	1
VC3 pin current	I _{VC3}	-	-0.8	0.0	0.8	μA	1
VC4 pin current	I _{VC4}	-	-0.8	0.0	0.8	μA	1
VC5 pin current	I _{VC5}	-	-0.8	0.0	0.8	μA	1
Output Pin							
CO pin voltage "H"*2	V _{COH}	V _{COH} < V _{DS}	4.0	6.0	8.0	V	1
DO pin voltage "H"*3	V _{DOH}	V _{DOH} < V _{DS}	4.0	6.0	8.0	V	1
CO pin source current	I _{COH}	-	10	-	-	μA	1
CO pin sink current	I _{COL}	V1 = V2 = V3 = V4 = V5 = 5.6 V	10	-	-	μA	1
DO pin source current	I _{DOH}	-	10	-	-	μA	1
DO pin sink current	I _{DOL}	-	10	-	-	μA	1
PSO pin source current	I _{PSOH}	-	10	-	-	μA	1
PSO pin sink current	I _{PSOL}	V1 = V2 = V3 = V4 = V5 = 1.9 V	10	-	-	μA	1
0 V Battery Detection Function							
0 V battery detection voltage n (n = 1 to 5)	V _{0INHn}	0 V battery detection function "available"	1.0	1.3	1.5	V	1

*1. Refer to "4. Delay time setting" in "■ Operation" for details of the delay time function.

*2. When V_{COH} ≥ V_{DS}, V_{COH} = V_{DD}

*3. When V_{DOH} ≥ V_{DS}, V_{DOH} = V_{DD}

Remark V_{DS}: Input voltage between VDD pin and VSS pin (V1 + V2 + V3 + V4 + V5)

BATTERY MONITORING IC FOR 3-SERIAL TO 5-SERIAL CELL PACK S-8255A Series

Rev.1.4_00

Table 6 (2 / 2)

(V1 = V2 = V3 = V4 = V5 = 3.5 V, Ta = +25°C unless otherwise specified)

Item	Symbol	Condition	Min.	Typ.	Max.	Unit	Test Circuit
Control Pin							
SEL1 pin voltage "H"	V _{SEL1H}	–	V _{DS} × 0.95	–	–	V	–
SEL2 pin voltage "H"	V _{SEL2H}	–	V _{DS} × 0.95	–	–	V	–
SEL1 pin voltage "L"	V _{SEL1L}	–	–	–	V _{DS} × 0.05	V	–
SEL2 pin voltage "L"	V _{SEL2L}	–	–	–	V _{DS} × 0.05	V	–
CTLC pin reverse voltage	V _{CTLC}	–	0.1	0.7	2.0	V	1
CTLD pin reverse voltage	V _{CTLD}	–	0.1	0.7	2.0	V	1
PSI pin reverse voltage	V _{PSI}	–	0.1	4.0	8.0	V	1
CTLC pin response delay time	t _{CTLC}	–	0.275	0.500	0.725	ms	1
CTLD pin response delay time	t _{CTLD}	–	0.275	0.500	0.725	ms	1
PSI pin response delay time	t _{PSI}	–	0.3	0.9	3.0	ms	1
CTLC pin current "H"	I _{CTLCH}	–	–0.1	0.0	0.1	μA	1
CTLC pin current "L"	I _{CTLCL}	–	–0.45	–0.20	–0.05	μA	1
CTLD pin current "H"	I _{CTLDH}	–	–0.1	0.0	0.1	μA	1
CTLD pin current "L"	I _{CTLDL}	–	–0.45	–0.20	–0.05	μA	1
PSI pin current "H"	I _{PSIH}	–	0.0	0.2	0.4	μA	1
PSI pin current "L"	I _{PSIL}	–	–0.1	0.0	0.1	μA	1
CTLC pin reverse voltage during communication	V _{CTLC_C}	5.1 MΩ resistance connected to the CTLC pin	V _{DS} + 0.2	V _{DS} + 0.7	V _{DS} + 1.3	V	3
CTLD pin reverse voltage during communication	V _{CTLD_C}	5.1 MΩ resistance connected to the CTLD pin	V _{DS} + 0.2	V _{DS} + 0.7	V _{DS} + 1.3	V	3
PSI pin reverse voltage during communication	V _{PSI_C}	5.1 MΩ resistance connected to the PSI pin	V _{SS} – 1.9	V _{SS} – 1.0	V _{SS} – 0.3	V	3
Temperature Detection Function							
Output voltage for temperature detection	V _{REG}	Voltage between VDD pin and VREG pin	4.0	5.0	6.0	V	2
High temperature detection ratio during charging	Γ _{THCH}	Γ _{THCH} = (V _{REG} – V _{TH}) / V _{REG}	Γ _{THCH} – 0.005	Γ _{THCH}	Γ _{THCH} + 0.005	–	2
Low temperature detection ratio during charging	Γ _{THCL}	Γ _{THCL} = (V _{REG} – V _{TH}) / V _{REG}	Γ _{THCL} – 0.005	Γ _{THCL}	Γ _{THCL} + 0.005	–	2
High temperature detection ratio during discharging	Γ _{THDH}	Γ _{THDH} = (V _{REG} – V _{TH}) / V _{REG}	Γ _{THDH} – 0.005	Γ _{THDH}	Γ _{THDH} + 0.005	–	2
Low temperature detection ratio during discharging	Γ _{THDL}	Γ _{THDL} = (V _{REG} – V _{TH}) / V _{REG}	Γ _{THDL} – 0.005	Γ _{THDL}	Γ _{THDL} + 0.005	–	2
THC/DX pin voltage "H"	V _{THH}	–	V _{DS} – 2.0	V _{DS} – 1.5	V _{DS} – 1.0	V	2
THC/DX pin voltage "L"	V _{THL}	–	0.5	1.0	1.5	V	2
Temperature detection delay time	t _{TH}	–	1.0	2.0	3.0	s	2

■ **Test Circuits**

Unless otherwise specified, for the CO pin output voltage (V_{CO}), DO pin output voltage (V_{DO}), and PSO pin output voltage (V_{PSO}), "L" or "H" is judged as follows.

L : $[V_{CO}, V_{DO}, V_{PSO}] \leq V_{DS} \times 0.1 \text{ V}$

H : $[V_{CO}, V_{DO}, V_{PSO}] > V_{DS} \times 0.1 \text{ V}$

Remark V_{DS} : Input voltage between VDD pin and VSS pin ($V1 + V2 + V3 + V4 + V5$)

1. Test circuit 1

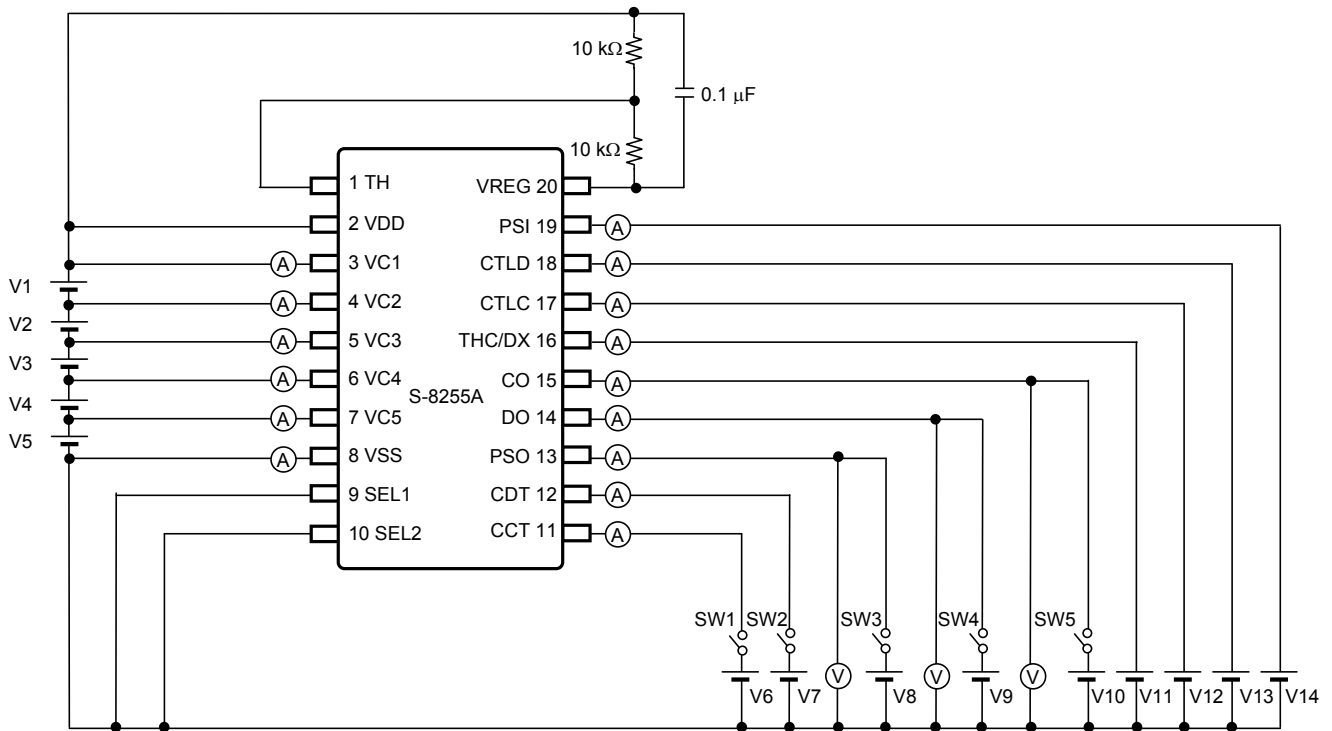

Figure 3 Test Circuit 1

This section provides explanations of Test items using Test circuit 1. Perform each test after setting as shown in Table 7.

Table 7 Initial Setting of Test Circuit 1 (1 / 2)

V1	V2	V3	V4	V5	V6	V7	V8	V9	V10
3.5 V	3.5 V	3.5 V	3.5 V	3.5 V	-	-	-	-	-

Table 7 Initial Setting of Test Circuit 1 (2 / 2)

V11	V12	V13	V14	SW1	SW2	SW3	SW4	SW5
0 V	0 V	0 V	V_{DS}	OFF	OFF	OFF	OFF	OFF

1.1 Overcharge detection voltage n (V_{CU_n}), overcharge release voltage n (V_{CL_n})

When the voltage V1 is gradually increased after setting $V1 = V2 = V3 = V4 = V5 = V_{CU_n} - 0.05\text{ V}$ and V_{CO} changes from "H" to "L", V1 is defined as the overcharge detection voltage 1 (V_{CU1}). When the voltage V1 is then gradually decreased and V_{CO} changes from "L" to "H", V1 is defined as the overcharge release voltage 1 (V_{CL1}). Overcharge detection voltage n (V_{CU_n}) and overcharge release voltage n (V_{CL_n}) (n = 2 to 5) can be determined in the same way as when n = 1.

1.2 Overdischarge detection voltage n (V_{DL_n}), overdischarge release voltage n (V_{DU_n})

When the voltage V1 is gradually decreased and V_{DO} changes from "H" to "L", V1 is defined as the overdischarge detection voltage 1 (V_{DL1}). When the voltage V1 is then gradually increased and V_{DO} changes from "L" to "H", V1 is defined as the overdischarge release voltage 1 (V_{DU1}). Overdischarge detection voltage n (V_{DL_n}) and overdischarge release voltage n (V_{DU_n}) (n = 2 to 5) can be determined in the same way as when n = 1.

1.3 CCT pin internal resistance (R_{CCT}), CCT pin detection voltage (V_{CCT})

The CCT pin internal resistance (R_{CCT}) is defined by $R_{CCT} = V_{DS} / I_{CCT}$ under the set conditions of $V1 = V_{CU1} + 0.025\text{ V}$ after setting $V6 = 0\text{ V}$ and setting SW1 to ON. When the voltage V6 is then gradually increased and V_{CO} changes from "H" to "L", V6 is defined as the CCT pin detection voltage (V_{CCT}).

1.4 CDT pin internal resistance (R_{CDT}), CDT pin detection voltage (V_{CDT})

The CDT pin internal resistance (R_{CDT}) is defined by $R_{CDT} = V_{DS} / I_{CDT}$ under the set conditions of $V1 = V_{DL1} - 0.085\text{ V}$ after setting $V7 = 0\text{ V}$ and setting SW2 to ON. When the voltage V7 is then gradually increased and V_{DO} changes from "H" to "L", V7 is defined as the CDT pin detection voltage (V_{CDT}).

1.5 Current consumption during operation (I_{OPE})

The current consumption during operation (I_{OPE}) is I_{VSS} under the initial setting shown in **Table 7**.

1.6 Current consumption during power-saving (I_{PSV})

The current consumption during power-saving (I_{PSV}) is I_{VSS} when $V14 = 0\text{ V}$.

1.7 CO pin source current (I_{COH})

The CO pin source current (I_{COH}) is I_{CO} when $V10 = V_{COH} - 0.5\text{ V}$ and SW5 is ON.

1.8 CO pin sink current (I_{COL})

The CO pin sink current (I_{COL}) is I_{CO} when $V1 = V2 = V3 = V4 = V5 = 4.6\text{ V}$, $V10 = 0.5\text{ V}$, and SW5 is ON.

1.9 DO pin source current (I_{DOH})

The DO pin source current (I_{DOH}) is I_{DO} when $V9 = V_{DOH} - 0.5\text{ V}$ and SW4 is ON.

1.10 DO pin sink current (I_{DOL})

The DO pin sink current (I_{DOL}) is I_{DO} when $V1 = V2 = V3 = V4 = V5 = 1.9\text{ V}$, $V9 = 0.5\text{ V}$, and SW4 is ON.

1.11 PSO pin source current (I_{PSOH})

The PSO pin source current (I_{PSOH}) is I_{PSO} when $V14 = 0\text{ V}$, $V8 = V_{DS} - 0.5\text{ V}$, and SW3 is ON.

1.12 PSO pin sink current (I_{PSOL})

The PSO pin sink current (I_{PSOL}) is I_{PSO} when $V8 = 0.5\text{ V}$ and SW3 is ON.

1.13 0 V battery detection voltage n (V_{0INHn}) (0 V battery detection function "available")

When the voltage V1 is gradually decreased and V_{CO} changes from "H" to "L", V1 is defined as the 0 V battery detection voltage 1 (V_{0INH1}).

0 V battery detection voltage n (V_{0INHn}) (n = 2 to 5) can be determined in the same way as when n = 1.

1.14 CTLC pin reverse voltage (V_{CTLC})

When the voltage V12 is gradually increased and V_{CO} changes from "H" to "L", V12 is defined as the CTLC pin reverse voltage (V_{CTLC}).

1.15 CTLD pin reverse voltage (V_{CTLD})

When the voltage V13 is gradually increased and V_{DO} changes from "H" to "L", V13 is defined as the CTLD pin reverse voltage (V_{CTLD}).

1.16 PSI pin reverse voltage (V_{PSI})

When the voltage V14 is gradually decreased and V_{PSO} changes from "L" to "H", V14 is defined as the PSI pin reverse voltage (V_{PSI}).

1.17 CTLC pin response delay time (t_{CTLC})

The CTLC pin response delay time (t_{CTLC}) is the time period from when the voltage V12 changes to $V12 = V_{DS}$ until when V_{CO} changes from "H" to "L".

1.18 CTLD pin response delay time (t_{CTLD})

The CTLD pin response delay time (t_{CTLD}) is the time period from when the voltage V13 changes to $V13 = V_{DS}$ until when V_{DO} changes from "H" to "L".

1.19 PSI pin response delay time (t_{PSI})

The PSI pin response delay time (t_{PSI}) is the time period from when the voltage V14 changes to $V14 = 0$ V until when V_{PSO} changes from "L" to "H".

1.20 CTLC pin current "H" (I_{CTLCH}), CTLC pin current "L" (I_{CTLCL})

The CTLC pin current "H" (I_{CTLCH}) is I_{CTLC} when $V12 = V_{DS}$.

The CTLC pin current "L" (I_{CTLCL}) is I_{CTLC} when $V12 = 0$ V.

1.21 CTLD pin current "H" (I_{CTLDH}), CTLD pin current "L" (I_{CTLDL})

The CTLD pin current "H" (I_{CTLDH}) is I_{CTLD} when $V13 = V_{DS}$.

The CTLD pin current "L" (I_{CTLDL}) is I_{CTLD} when $V13 = 0$ V.

1.22 PSI pin current "H" (I_{PSIH}), PSI pin current "L" (I_{PSIL})

The PSI pin current "H" (I_{PSIH}) is I_{PSI} when $V14 = V_{DS}$.

The PSI pin current "L" (I_{PSIL}) is I_{PSI} when $V14 = 0$ V.

2. Test circuit 2

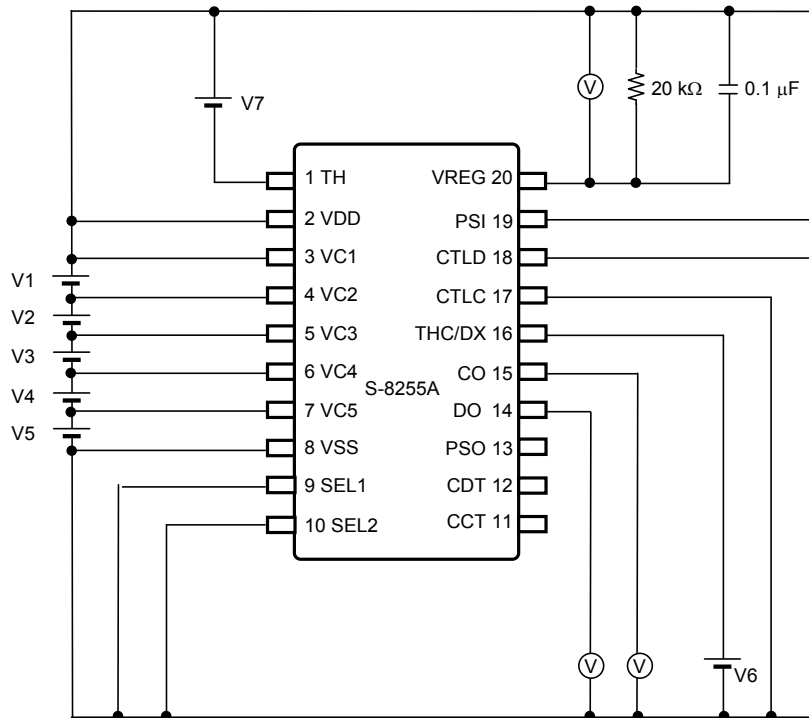

Figure 4 Test Circuit 2

This section provides explanations of Test items using Test circuit 2. Perform each test after setting as shown in **Table 8**.

Table 8 Initial Setting of Test Circuit 2

V1	V2	V3	V4	V5	V6	V7 ^{*1}
3.5 V	3.5 V	3.5 V	3.5 V	3.5 V	0 V	2.5 V

*1. V7 is an absolute value.

2.1 Output voltage for temperature detection (V_{REG})

The maximum voltage between the VDD pin and VREG pin is defined as the output voltage for temperature detection (V_{REG}).

2.2 High temperature detection ratio during charging (r_{THCH})

When the voltage V7 is gradually decreased after setting V6 = V_{DS} and V_{CO} changes from "H" to "L", the high temperature detection ratio during charging (r_{THCH}) is defined by (V_{REG} - V7) / V_{REG}.

2.3 Low temperature detection ratio during charging (r_{THCL})

When the voltage V7 is gradually increased after setting V6 = V_{DS} and V_{CO} changes from "H" to "L", the low temperature detection ratio during charging (r_{THCL}) is defined by (V_{REG} - V7) / V_{REG}.

2.4 High temperature detection ratio during discharging (r_{THDH})

When the voltage V7 is gradually decreased and V_{CO} changes from "H" to "L" and V_{DO} changes from "H" to "L", the high temperature detection ratio during discharging (r_{THDH}) is defined by (V_{REG} - V7) / V_{REG}.

2.5 Low temperature detection ratio during discharging (r_{THDL})

When the voltage V7 is gradually increased and V_{CO} changes from "H" to "L" and V_{DO} changes from "H" to "L", the low temperature detection ratio during discharging (r_{THDL}) is defined by (V_{REG} - V7) / V_{REG}.

2.6 THC/DX pin voltage "H" (V_{THH})

When the voltage V_6 is gradually increased after setting $(1 - \Gamma_{THDH}) \times V_{REG} < V_7 < (1 - \Gamma_{THCH}) \times V_{REG}$ and V_{DO} changes from "L" to "H", V_6 is defined as the THC/DX pin voltage "H" (V_{THH}).

2.7 THC/DX pin voltage "L" (V_{THL})

When the voltage V_6 is gradually decreased after setting $(1 - \Gamma_{THDH}) \times V_{REG} < V_7 < (1 - \Gamma_{THCH}) \times V_{REG}$ and V_{DO} changes from "H" to "L", V_6 is defined as the THC/DX pin voltage "L" (V_{THL}).

2.8 Temperature detection delay time (t_{TH})

The temperature detection delay time (t_{TH}) is the time period from when the voltage V_7 changes to 0 V until when V_{CO} changes from "H" to "L" and V_{DO} changes from "H" to "L".

3. Test circuit 3

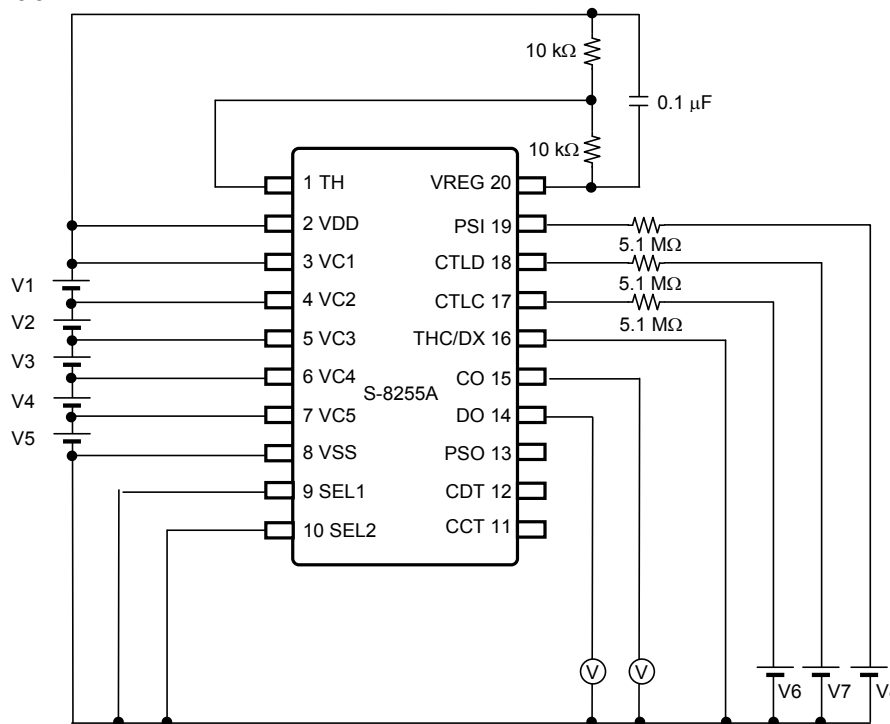

Figure 5 Test Circuit 3

This section provides explanations of Test items using Test circuit 3. Perform each test after setting as shown in **Table 9**.

Table 9 Initial Setting of Test Circuit 3

V1	V2	V3	V4	V5	V6	V7	V8
3.5 V	3.5 V	3.5 V	3.5 V	3.5 V	$V_{DS} + 2.0 V$	$V_{DS} + 2.0 V$	-2.0 V

3.1 CTLC pin reverse voltage during communication (V_{CTLC_C})

When the voltage V_6 is gradually decreased and V_{CO} changes from "H" to "L", V_6 is defined as the CTLC pin reverse voltage during communication (V_{CTLC_C}).

3.2 CTLD pin reverse voltage during communication (V_{CTLD_C})

When the voltage V_7 is gradually decreased and V_{DO} changes from "H" to "L", V_7 is defined as the CTLD pin reverse voltage during communication (V_{CTLD_C}).

3.3 PSI pin reverse voltage during communication (V_{PSI_C})

When the voltage V_8 is gradually increased and V_{PSO} changes from "L" to "H", V_8 is defined as the PSI pin reverse voltage during communication (V_{PSI_C}).

■ Operation

Remark Refer to "■ Connection Examples of Battery Protection IC".

1. Normal status

The status when CO pin output voltage (V_{CO}) = "H", DO pin output voltage (V_{DO}) = "H" and PSO pin output voltage (V_{PSO}) = "L" is the normal status.

All the conditions mentioned below should be satisfied for returning to the normal status.

- The voltage of each of the batteries is in the range from overcharge detection voltage n (V_{CUn}) to overdischarge detection voltage n (V_{DLn}).
- CTLC pin voltage and CTLD pin voltage are lower than CTLC pin reverse voltage (V_{CTLC}) and CTLD pin reverse voltage (V_{CTLD}), respectively, and PSI pin voltage is higher than PSI pin reverse voltage (V_{PSI}).
- Either (1) or (2) below is satisfied for TH pin voltage (V_{TH}).

$$(1) \text{ When } V_{THC/DX} \geq V_{THH}: (1 - \Gamma_{THCH}) \times V_{REG} < V_{TH} < (1 - \Gamma_{THCL}) \times V_{REG}$$

$$(2) \text{ When } V_{THC/DX} \leq V_{THL}: (1 - \Gamma_{THDH}) \times V_{REG} < V_{TH} < (1 - \Gamma_{THDL}) \times V_{REG}$$

Caution After the battery is connected, there may be cases when discharging cannot be performed. In this case, the S-8255A Series returns to the normal status when the following condition is satisfied.

- Changing the PSI pin voltage to be $V_{DS} \rightarrow 0V \rightarrow V_{DS}$

Remark

- $V_{THC/DX}$: THC/DX pin voltage
- V_{THH} : THC/DX pin voltage "H"
- V_{THL} : THC/DX pin voltage "L"
- Γ_{THCH} : High temperature detection ratio during charging
- Γ_{THCL} : Low temperature detection ratio during charging
- Γ_{THDH} : High temperature detection ratio during discharging
- Γ_{THDL} : Low temperature detection ratio during discharging
- V_{REG} : Output voltage for temperature detection
- V_{DS} : Input voltage between VDD pin and VSS pin ($V1 + V2 + V3 + V4 + V5$)

2. Overcharge status

When the voltage of any of the batteries exceeds the overcharge detection voltage n (V_{CUn}) and the status continues for the overcharge detection delay time (t_{CU})*1 or longer, the CO pin changes to the V_{SS} level. This is the overcharge status.

The overcharge status is released if the following condition is satisfied.

- Voltage of battery $\leq V_{CLn}$

*1. Refer to "4. Delay time setting" for details.

Remark V_{CLn} : Overcharge release voltage n (n = 1 to 5)

3. Overdischarge status

When the voltage of any of the batteries falls below the overdischarge detection voltage n (V_{DLn}) and the status continues for the overdischarge detection delay time (t_{DL})^{*1} or longer, the DO pin changes to the V_{SS} level. This is the overdischarge status.

The overdischarge status is released if the following condition is satisfied.

- Voltage of battery $\geq V_{DUn}$

*1. Refer to "4. Delay time setting" for details.

Remark V_{DUn} : Overdischarge release voltage n ($n = 1$ to 5)

4. Delay time setting

Users are able to set delay time for the period from when the S-8255A Series detects change in the voltage of any of the batteries until when it outputs to the CO pin or DO pin. Each delay time is determined by a resistor in the S-8255A Series and an external capacitor.

In the overcharge detection, when the voltage of any of the batteries exceeds overcharge detection voltage n (V_{CU_n}), the S-8255A Series starts charging to the CCT pin's capacitor (C_{CCT}) via the CCT pin internal resistance (R_{CCT}). After a certain period, the CO pin changes to the V_{SS} level when the voltage at the CCT pin reaches the CCT pin detection voltage (V_{CCT}). This period is overcharge detection delay time (t_{CU}).

t_{CU} is calculated using the following equation.

$$\begin{aligned} t_{CU} [\text{s}] &= -\ln(1 - V_{CCT} / V_{DS}) \times C_{CCT} [\mu\text{F}] \times R_{CCT} [\text{M}\Omega] \\ &= -\ln(1 - 0.7 \text{ typ.}) \times C_{CCT} [\mu\text{F}] \times 8.31 [\text{M}\Omega] \text{ typ.} \\ &= 10.0 [\text{M}\Omega] \text{ typ.} \times C_{CCT} [\mu\text{F}] \end{aligned}$$

Overdischarge detection delay time (t_{DL}) is calculated using the following equations as well.

$$t_{DL} [\text{ms}] = -\ln(1 - V_{CDT} / V_{DS}) \times C_{CDT} [\mu\text{F}] \times R_{CDT} [\text{k}\Omega]$$

When $C_{CCT} = C_{CDT} = 0.1 [\mu\text{F}]$, each delay time is calculated as follows.

$$\begin{aligned} t_{CU} [\text{s}] &= 10.0 [\text{M}\Omega] \text{ typ.} \times 0.1 [\mu\text{F}] = 1.0 [\text{s}] \text{ typ.} \\ t_{DL} [\text{ms}] &= 1000 [\text{k}\Omega] \text{ typ.} \times 0.1 [\mu\text{F}] = 100 [\text{ms}] \text{ typ.} \end{aligned}$$

Remark V_{DS} : Input voltage between VDD pin and VSS pin ($V1 + V2 + V3 + V4 + V5$)

5. 0 V Battery detection function

For detection function of self-discharged battery (0 V battery), "available" / "unavailable" is selectable.

- 0 V battery detection function "available"
The voltage V_{CO} changes to the V_{SS} level when the voltage of any of the batteries is V_{0INHn} or lower.

Caution When the VDD pin voltage is lower than the minimum value of operation voltage between VDD pin and VSS pin (V_{DSOP}), the S-8255A Series' operation is not assured.

Remark V_{0INHn} : 0 V battery detection voltage n ($n = 1$ to 5)
 V_{CO} : CO pin voltage

6. SEL1 pin and SEL2 pin

Switching control for 3-serial to 5-serial cell is possible by inputting voltage to the SEL1 pin and the SEL2 pin. Be sure to use the SEL1 pin and the SEL2 pin at the "H" or "L" level.

Table 10 Settings of SEL1 Pin and SEL2 Pin

SEL1 Pin	SEL2 Pin	Setting
"L"	"L"	5-serial cell monitoring
"L"	"H"	4-serial cell monitoring
"H"	"L"	3-serial cell monitoring
"H"	"H"	Setting inhibited

Remark "H" is the status when $V_{SEL1} \geq V_{SEL1H}$, $V_{SEL2} \geq V_{SEL2H}$, and "L" is the status when $V_{SEL1} \leq V_{SEL1L}$, $V_{SEL2} \leq V_{SEL2L}$.

V_{SEL1H} : SEL1 pin voltage "H"
 V_{SEL2H} : SEL2 pin voltage "H"
 V_{SEL1L} : SEL1 pin voltage "L"
 V_{SEL2L} : SEL2 pin voltage "L"

7. CTLC pin and CTLD pin

The CTLC pin controls the CO pin, and the CTLD pin controls the DO pin. Thus it is possible for users to control the CO pin and the DO pin respectively. These controls precede the battery monitoring circuit.

Table 11 Status Set by CTLC Pin

CTLC Pin	CO Pin
$V_{SS} \text{ level} \leq \text{CTLC pin voltage} < V_{CTLC}$	"H"
$V_{CTLC} \leq \text{CTLC pin voltage} \leq V_{DD} \text{ level}$	$V_{SS} \text{ level}$
$V_{DD} \text{ level} < \text{CTLC pin voltage} \leq V_{CTLC_C}$	$V_{SS} \text{ level}$
$V_{CTLC_C} < \text{CTLC pin voltage}$	"H"

Remark CTLC pin is at the V_{DD} level or higher in cascade connection. Connect a resistor of 5.1 M Ω to the CTLC pin in this case.

V_{CTLC} : CTLC pin reverse voltage
 V_{CTLC_C} : CTLC pin reverse voltage during communication

Table 12 Status Set by CTLD Pin

CTLD Pin	DO Pin
$V_{SS} \text{ level} \leq \text{CTLD pin voltage} < V_{CTLD}$	"H"
$V_{CTLD} \leq \text{CTLD pin voltage} \leq V_{DD} \text{ level}$	$V_{SS} \text{ level}$
$V_{DD} \text{ level} < \text{CTLD pin voltage} \leq V_{CTLD_C}$	$V_{SS} \text{ level}$
$V_{CTLD_C} < \text{CTLD pin voltage}$	"H"

Remark CTLD pin is at the V_{DD} level or higher in cascade connection. Connect a resistor of 5.1 M Ω to the CTLD pin in this case.

V_{CTLD} : CTLD pin reverse voltage
 V_{CTLD_C} : CTLD pin reverse voltage during communication

8. PSI pin

When the PSI pin is activated, the power-saving function starts to operate, and most operations halt. In this case, the CO pin and DO pin change to the V_{SS} level, and the PSO pin changes to the V_{DD} level.

Table 13 Status Set by PSI Pin

PSI Pin	CO Pin	DO Pin	PSO Pin
$V_{PSI} < \text{PSI pin voltage} \leq V_{DD}$ level	"H"	"H"	V_{SS} level
V_{SS} level \leq PSI pin voltage $\leq V_{PSI}$	V_{SS} level	V_{SS} level	V_{DD} level
$V_{PSI_C} < \text{PSI pin voltage} < V_{SS}$ level	V_{SS} level	V_{SS} level	V_{DD} level
PSI pin voltage $< V_{PSI_C}$	"H"	"H"	V_{SS} level

Remark PSI pin is at the V_{SS} level or lower in cascade connection.
 Connect a resistor of 5.1 M Ω to the PSI pin in this case.

V_{PSI} : PSI pin reverse voltage

V_{PSI_C} : PSI pin reverse voltage during communication

The S-8255A Series is initialized and the power-saving function is released by deactivating the PSI pin. As a result, each detection operation is carried out after returning to the normal status.

9. Temperature detection

Serially connect an NTC and a low temperature-dependent resistor (R_{TH}) between the VDD pin and the VREG pin, and then connect their middle point to the TH pin. It allows for temperature detection at four different points: high temperature detection during charging, low temperature detection during charging, high temperature detection during discharging, low temperature detection during discharging.

When the temperature rises, according to the NTC temperature characteristics, the resistance (R_{NTC}) decreases, and the ratio between R_{NTC} and R_{TH} changes, and then the TH pin voltage (V_{TH}) increases.

When the temperature falls, according to the NTC temperature characteristics, the resistance (R_{NTC}) increases, and the ratio between R_{NTC} and R_{TH} changes, and then the TH pin voltage (V_{TH}) decreases.

The temperature detection during charging and temperature detection during discharging switch by comparing THC/DX pin voltage ($V_{THC/DX}$) and either of THC/DX pin voltage "H" or "L" (V_{THH} , V_{THL}).

If the relation between R_{NTC} , R_{TH} , and $V_{THC/DX}$ satisfies the itemized condition in **Table 14** in each temperature detection, and each status continues for the temperature detection delay time (t_{TH}) or longer, the CO pin changes to the V_{SS} level and the DO pin changes to the "H" or V_{SS} level. This is the temperature protection status.

If the itemized condition in **Table 14** is not satisfied in each temperature detection, and each status continues for t_{TH} or longer, the temperature protection status is released.

Table 14 Conditions for Each Temperature Detection

Item	TH Pin	THC/DX Pin	CO Pin	DO Pin
High temperature detection during charging	$\Gamma_{THCH} \leq R_{TH} / (R_{NTC} + R_{TH})$	$V_{THC/DX} \geq V_{THH}$	V_{SS} level	"H"
Low temperature detection during charging	$\Gamma_{THCL} \geq R_{TH} / (R_{NTC} + R_{TH})$	$V_{THC/DX} \geq V_{THH}$		V_{SS} level
High temperature detection during discharging	$\Gamma_{THDH} \leq R_{TH} / (R_{NTC} + R_{TH})$	$V_{THC/DX} \leq V_{THL}$		V_{SS} level
Low temperature detection during discharging	$\Gamma_{THDL} \geq R_{TH} / (R_{NTC} + R_{TH})$	$V_{THC/DX} \leq V_{THL}$		V_{SS} level

Remark Γ_{THCH} : High temperature detection ratio during charging

Γ_{THCL} : Low temperature detection ratio during charging

Γ_{THDH} : High temperature detection ratio during discharging

Γ_{THDL} : Low temperature detection ratio during discharging

The detection temperature can be set according to the NTC and R_{TH} characteristics.
 For example, if R_{NTC}^{*1} and R_{TH} (10 k Ω) are connected to S-8255AAA, each detection temperature is as follows.

Table 15

Item	Temperature Detection Ratio	R_{NTC}	Detection Temperature
Temperature for high temperature detection during charging	$\Gamma_{THCH} = 0.670$	4.9 k Ω	45°C
Temperature for low temperature detection during charging	$\Gamma_{THCL} = 0.270$	27.0 k Ω	0°C
Temperature for high temperature detection during discharging	$\Gamma_{THDH} = 0.795$	2.6 k Ω	65°C
Temperature for low temperature detection during discharging	$\Gamma_{THDL} = 0.190$	42.6 k Ω	-10°C

*1. The calculation method for R_{NTC} is as follows.

$$\begin{aligned} \Gamma_{THCL} &= R_{TH} / (R_{NTC} + R_{TH}) \\ R_{NTC} &= R_{TH} / \Gamma_{THCL} - R_{TH} \\ &= 10 \text{ k}\Omega / 0.270 - 10 \text{ k}\Omega \\ &= 27.0 \text{ k}\Omega \end{aligned}$$

When low temperature during charging is detected, $R_{NTC} = 27.0 \text{ k}\Omega$, so detection temperature = 0°C according to the R_{NTC} characteristics shown in **Figure 6**.

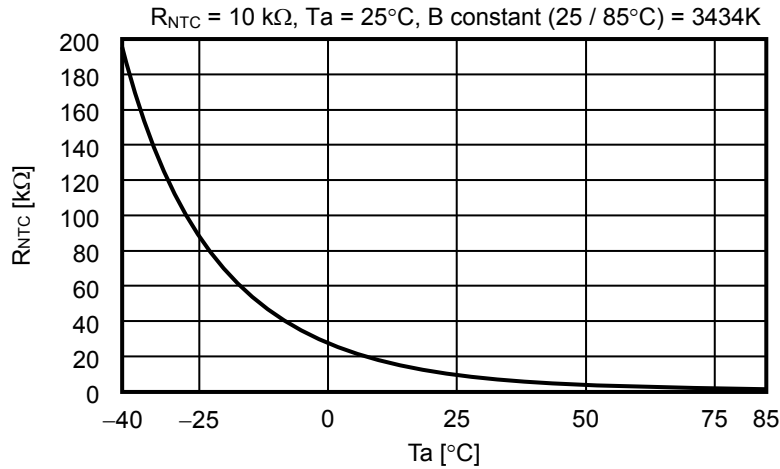
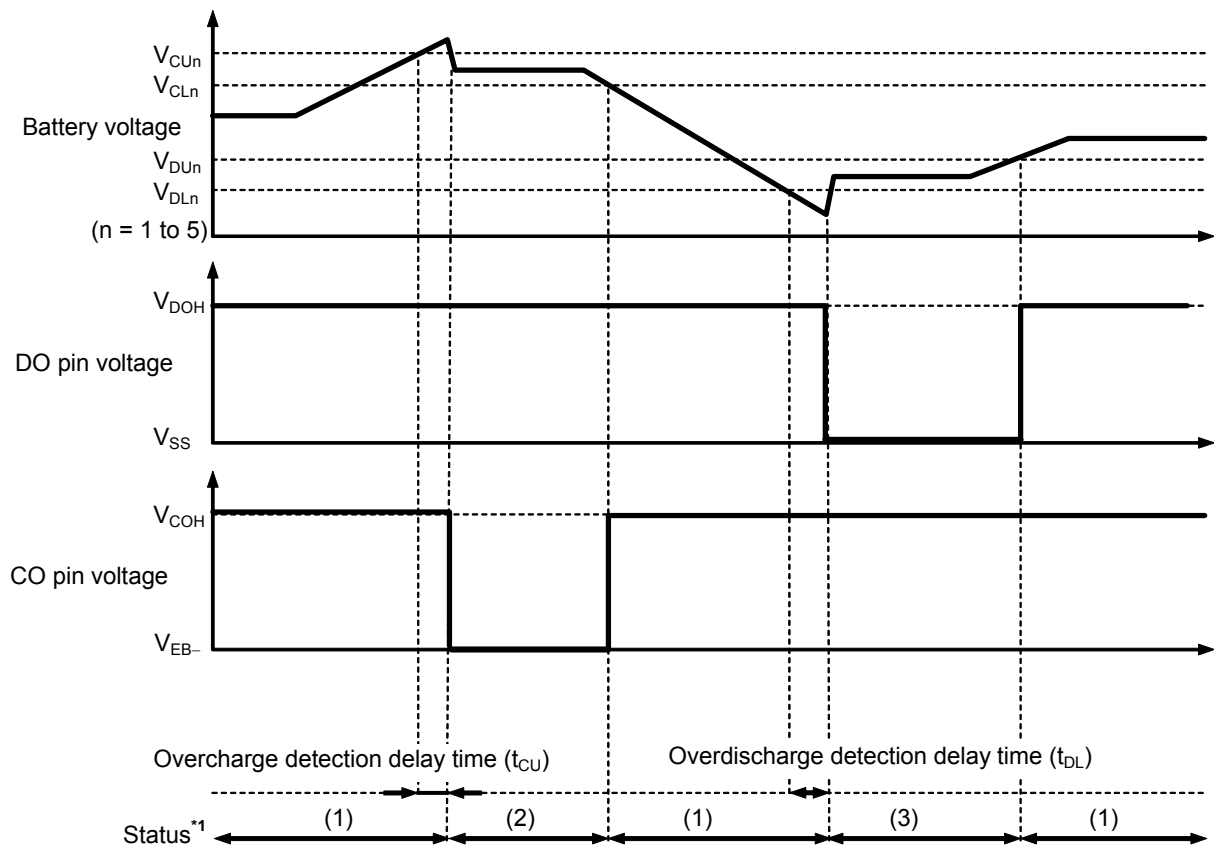

Figure 6 Example of R_{NTC} Characteristics

Remark Temperature detection is carried out intermittently for 512 ms typ. per cycle, of which 1 ms typ. is the detection operation period.
 The VREG pin voltage is output only during detection operation. During other periods, the VREG pin is at the V_{DD} level.
 Regarding details of intermittent operation, refer to "2. Temperature detection (High temperature detection during charging)" in "■ Timing Charts".

■ **Timing Charts**

1. **Overcharge detection, overdischarge detection**



- *1. (1) : Normal status
 (2) : Overcharge status
 (3) : Overdischarge status

Figure 7

2. Temperature detection (High temperature detection during charging)

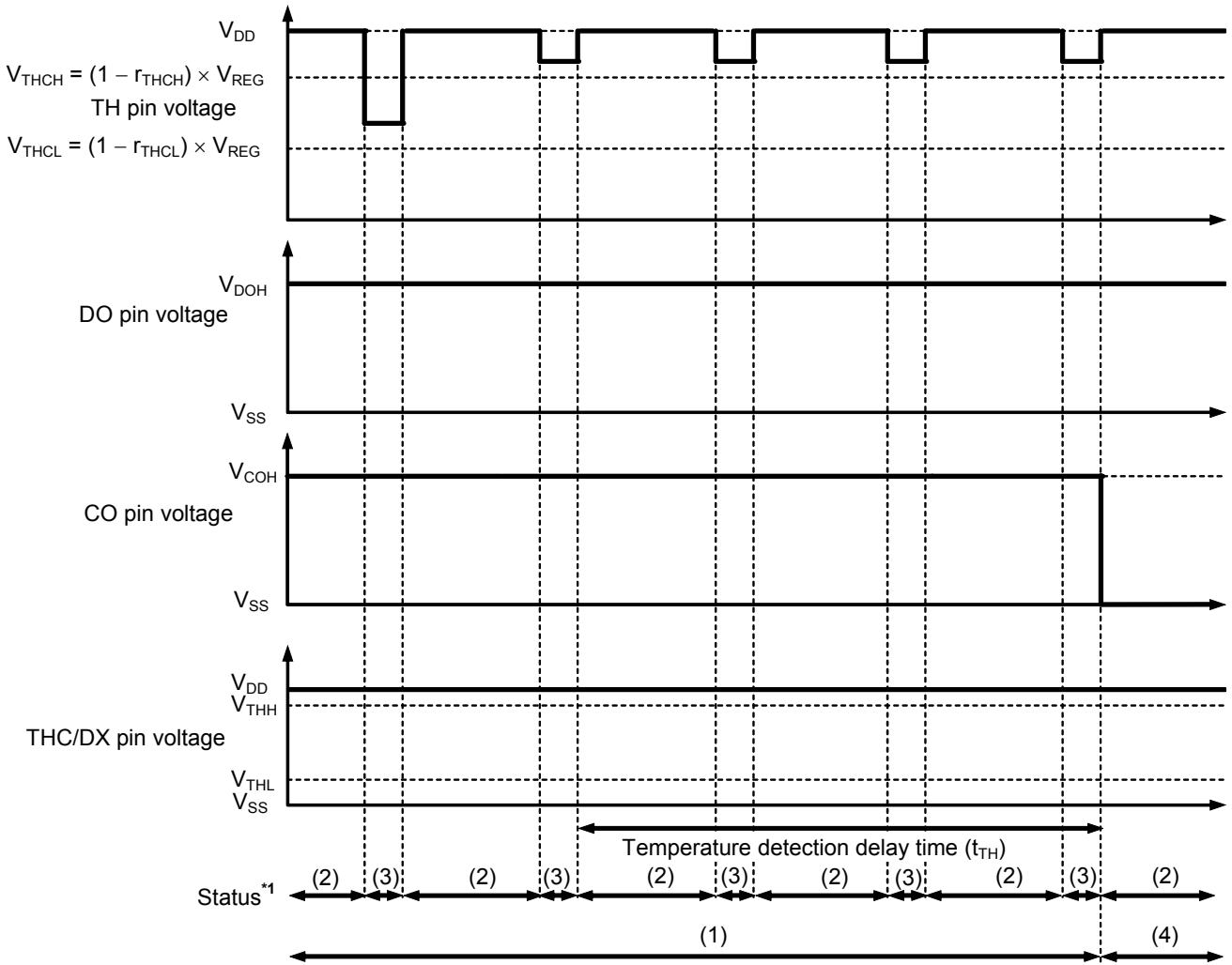

- *1. (1) : Normal status
- (2) : Temperature detection sleep time
- (3) : Temperature detection awake time
- (4) : Temperature protection status

Figure 8

■ **Connection Example of Battery Monitoring IC**

1. **S-8255A Series (10-serial cell)**

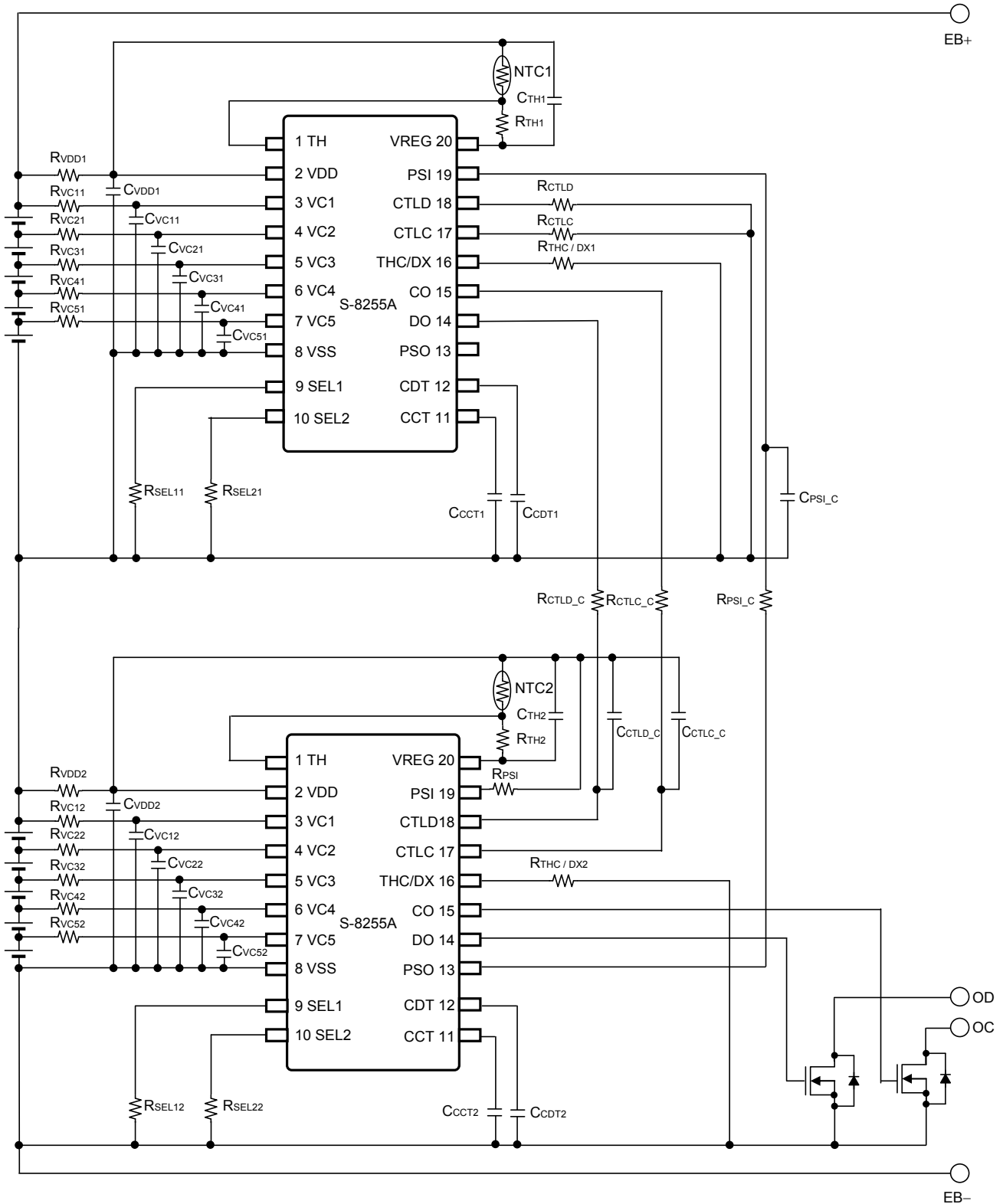

Remark Regarding the recommended values for external components, refer to "Table 16 Constants for External Components".

Figure 9

Table 16 Constants for External Components

Symbol	Min.	Typ.	Max.	Unit
$R_{VDD1}^{*1}, R_{VDD2}^{*1}$	68	100	100	Ω
$R_{VCn1}, R_{VCn2} (n = 1 \text{ to } 5)^{*1}$	0.68	1.00	1.00	$k\Omega$
$R_{SEL11}, R_{SEL12}, R_{SEL21}, R_{SEL22}$	1	1	–	$k\Omega$
$R_{CTL C}, R_{CTLD C}, R_{PSI C}$	1.0	2.0	5.1	$k\Omega$
$R_{THC/DX1}, R_{THC/DX2}$	1.0	1.0	–	$k\Omega$
$R_{CTL C C}, R_{CTLD C C}, R_{PSI C C}$	4.0	5.1	6.0	$M\Omega$
$NTC1, NTC2$	–	10	–	$k\Omega$
R_{TH1}, R_{TH2}	–	10	–	$k\Omega$
C_{VDD1}, C_{VDD2}^{*1}	0.68	1.00	10.00	μF
$C_{VCn1}, C_{VCn2} (n = 1 \text{ to } 5)^{*1}$	0.068	0.100	1.000	μF
$C_{CTL C C}, C_{CTLD C C}, C_{PSI C C}$	470	470	–	pF
C_{CCT1}, C_{CCT2}	0.01	0.10	–	μF
C_{CDT1}, C_{CDT2}	0.01	0.10	–	μF
C_{TH1}, C_{TH2}	0.1	0.1	0.1	μF

*1. $R_{VDD1} \times C_{VDD1} = R_{VDD2} \times C_{VDD2} = 100 \mu F \bullet \Omega$ is recommended.
 Set filter constants to satisfy $R_{VC1} \times C_{VC1} = R_{VC2} \times C_{VC2} = R_{VC3} \times C_{VC3} = R_{VC4} \times C_{VC4} = R_{VC5} \times C_{VC5} = R_{VDD1} \times C_{VDD1}$.

- Caution 1. The above constants may be changed without notice.**
- Sufficient evaluation of transient power supply fluctuation and overcurrent protection function with the actual application is needed to determine the proper constants when setting the filter constants between the VDD pin and VSS pin. Contact our sales office if setting the constants between the VDD pin and VSS pin to anything other than the recommended values.**
 - It has not been confirmed whether the operation is normal or not in circuits other than the connection example. In addition, the connection example and the constants do not guarantee proper operation. Perform thorough evaluation using the actual application to set the constants.**

■ Precautions

- The application conditions for the input voltage, output voltage, and load current should not exceed the power dissipation.
- Batteries can be connected in any order; however, there may be cases when discharging cannot be performed after a battery is connected. In this case, the S-8255A Series returns to the normal status when the following condition is satisfied.
 - Changing the PSI pin voltage to be $V_{DS} \rightarrow 0\text{ V} \rightarrow V_{DS}$

Remark V_{DS} : Input voltage between VDD pin and VSS pin ($V1 + V2 + V3 + V4 + V5$)

- Do not apply an electrostatic discharge to this IC that exceeds the performance ratings of the built-in electrostatic protection circuit.
- ABLIC Inc. claims no responsibility for any disputes arising out of or in connection with any infringement by products including this IC of patents owned by a third party.

■ Characteristics (Typical Data)

1. Current consumption

1.1 I_{OPE} vs. V_{DS}

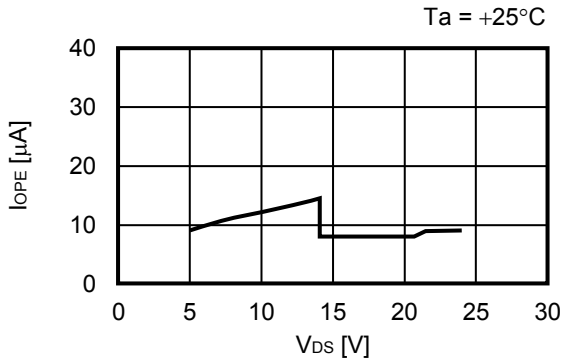

1.2 I_{OPE} vs. T_a

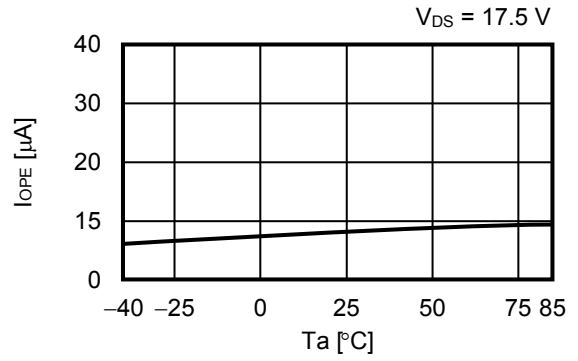

1.3 I_{PSV} vs. V_{DS}

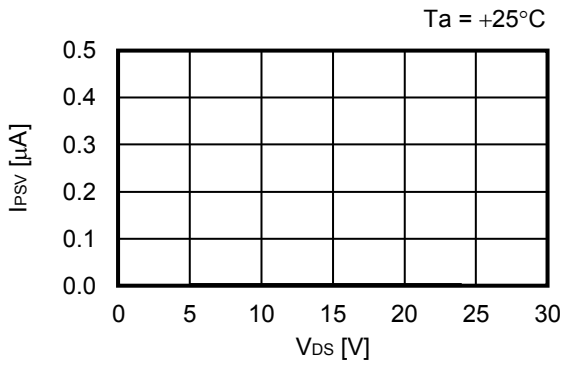

1.4 I_{PSV} vs. T_a

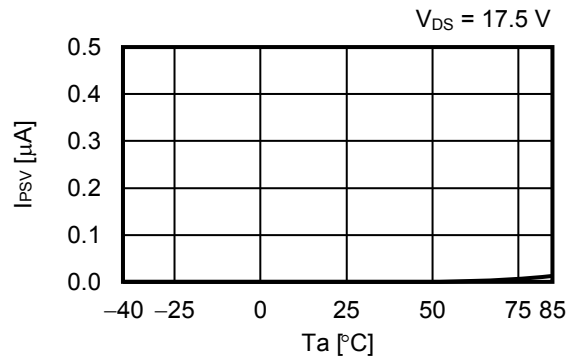

2. Detection voltage, release voltage

2.1 V_{CU} vs. T_a

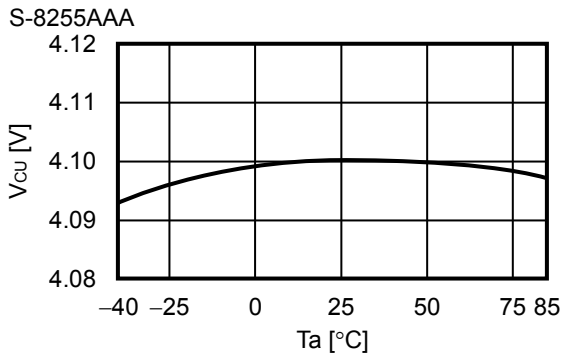

2.2 V_{CL} vs. T_a

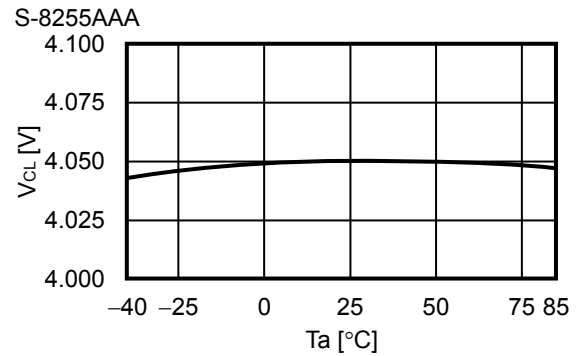

2.3 V_{DL} vs. T_a

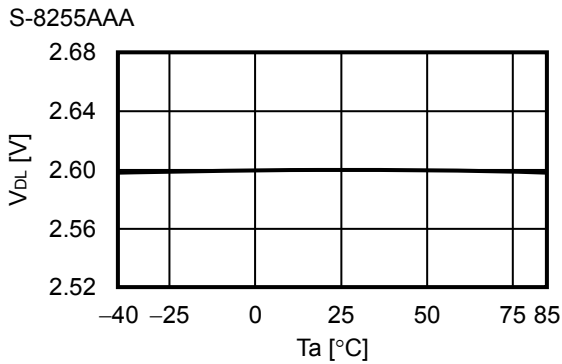

2.4 V_{DU} vs. T_a

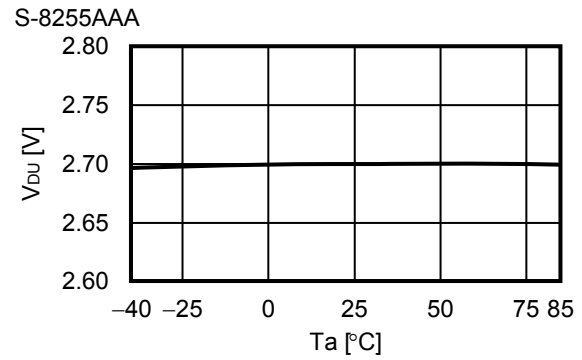

3. Delay time function

3.1 R_{CCT} vs. T_a

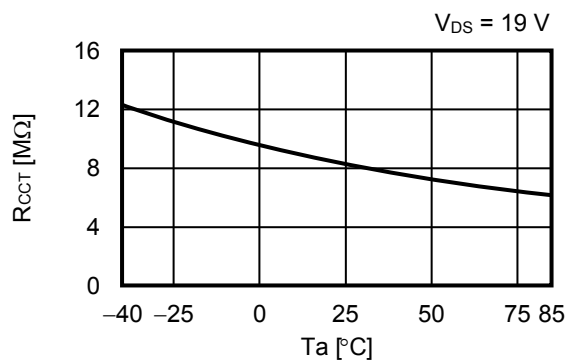

3.2 V_{CCT} vs. T_a

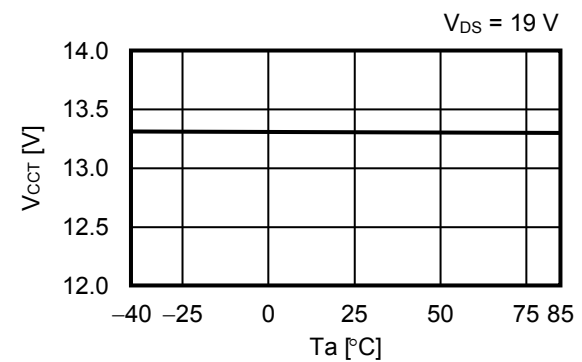

3.3 R_{CDT} vs. T_a

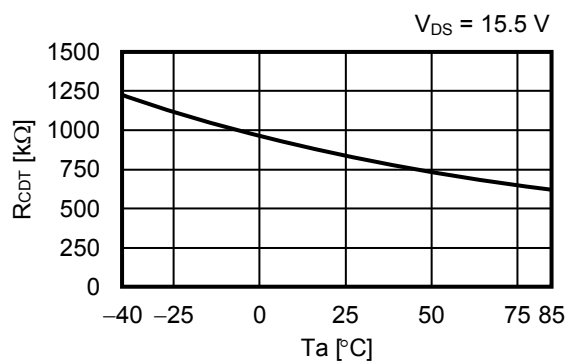

3.4 V_{CDT} vs. T_a

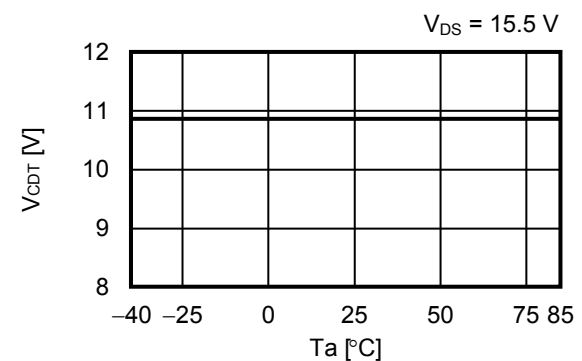

4. Output pin

4.1 I_{COH} vs. V_{DS}

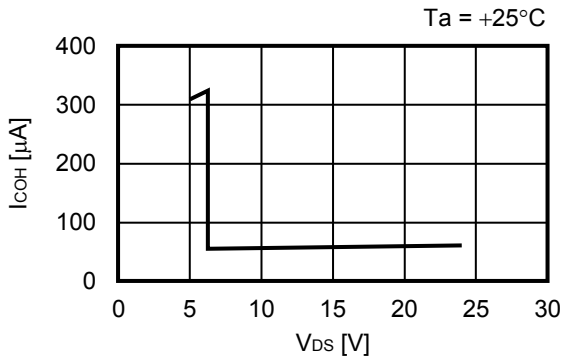

4.2 I_{COL} vs. V_{DS}

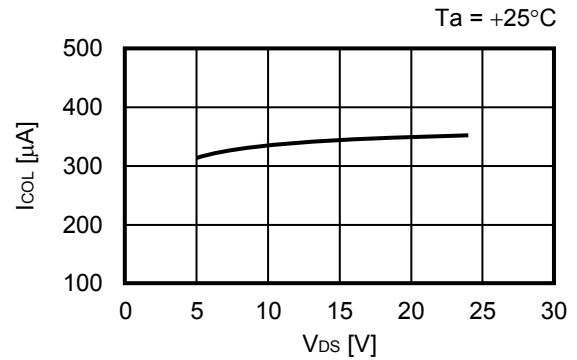

4.3 I_{DOH} vs. V_{DS}

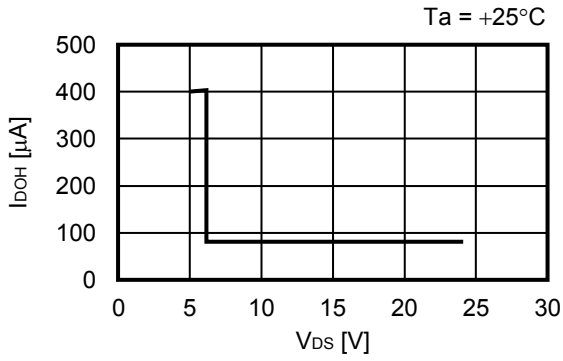

4.4 I_{DOL} vs. V_{DS}

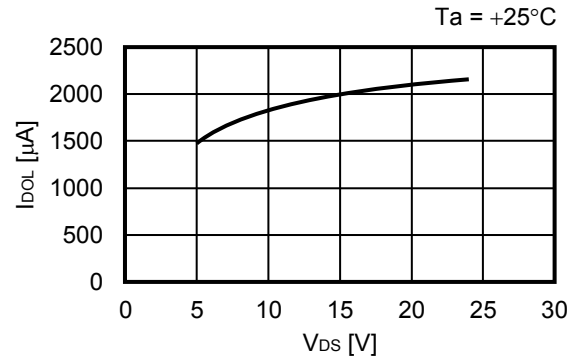

4.5 I_{PSOH} vs. V_{DS}

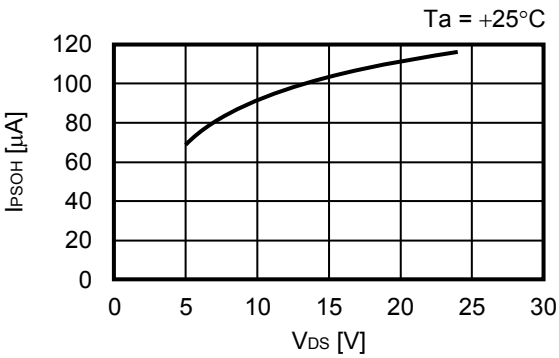

4.6 I_{PSOL} vs. V_{DS}

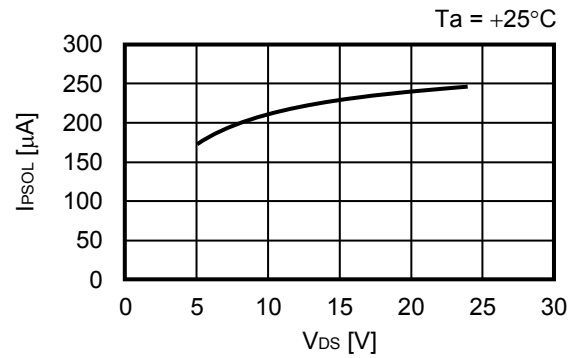

5. Temperature detection function

5.1 r_{THCH} vs. T_a

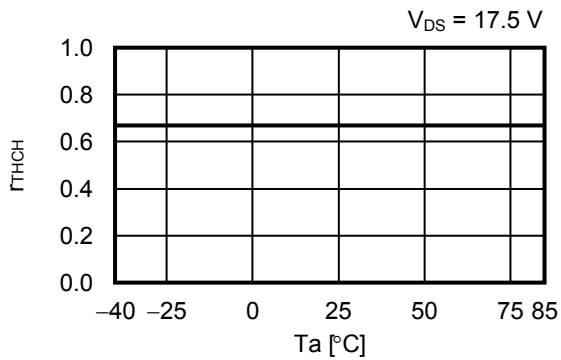

5.2 r_{THCL} vs. T_a

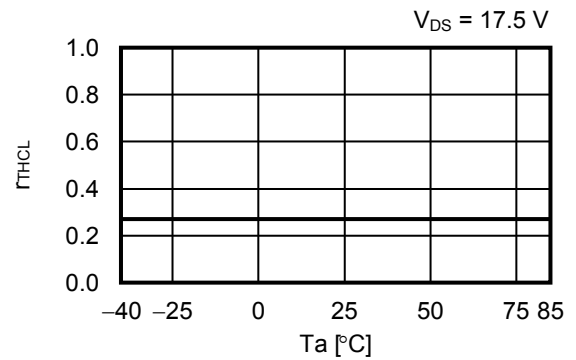

5.3 r_{THDH} vs. T_a

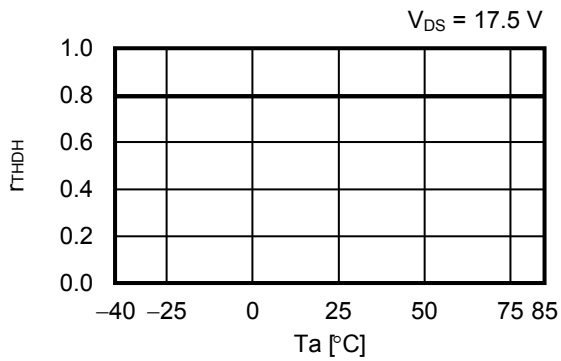

5.4 r_{THDL} vs. T_a

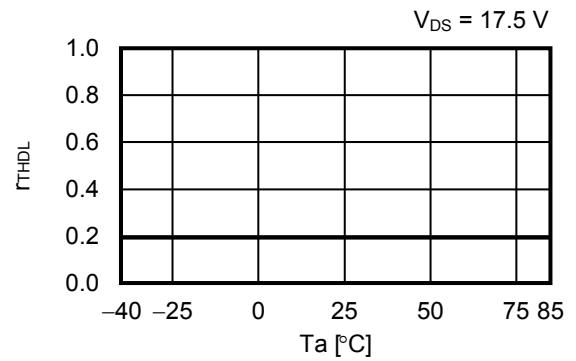

5.5 V_{REG} vs. T_a

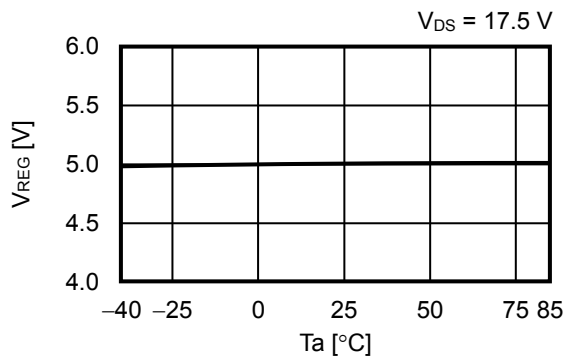

5.6 t_{TH} vs. T_a

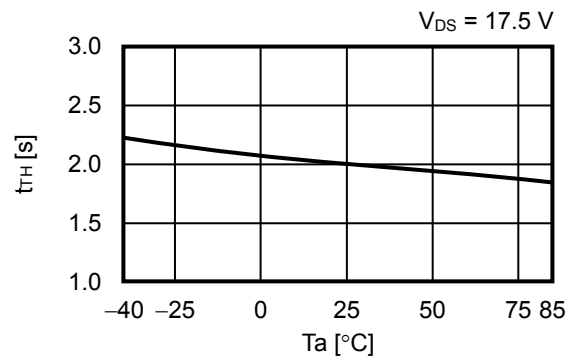

■ **Power Dissipation**

20-Pin TSSOP

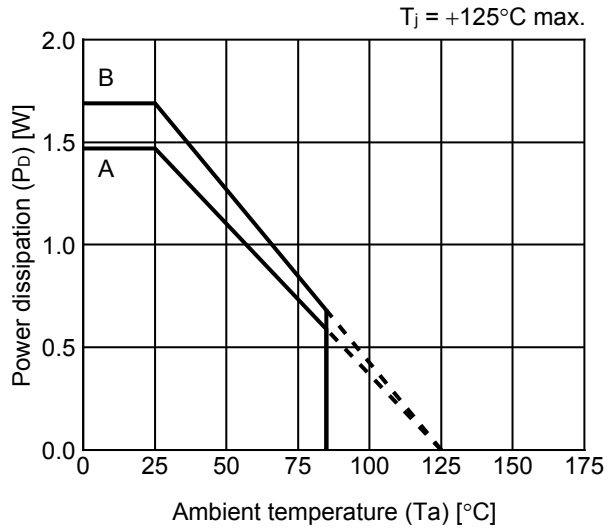

Board	Power Dissipation (P_D)
A	1.47 W
B	1.69 W
C	—
D	—
E	—

20-Pin TSSOP Test Board

 IC Mount Area

(1) Board A

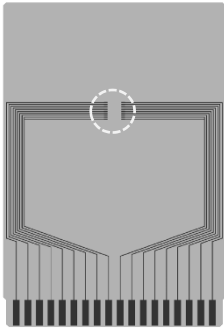

Item		Specification
Size [mm]		114.3 x 76.2 x t1.6
Material		FR-4
Number of copper foil layer		2
Copper foil layer [mm]	1	Land pattern and wiring for testing: t0.070
	2	-
	3	-
	4	74.2 x 74.2 x t0.070
Thermal via		-

(2) Board B

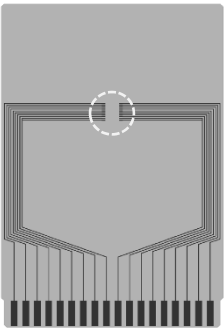

Item		Specification
Size [mm]		114.3 x 76.2 x t1.6
Material		FR-4
Number of copper foil layer		4
Copper foil layer [mm]	1	Land pattern and wiring for testing: t0.070
	2	74.2 x 74.2 x t0.035
	3	74.2 x 74.2 x t0.035
	4	74.2 x 74.2 x t0.070
Thermal via		-

No. TSSOP20-A-Board-SD-1.0

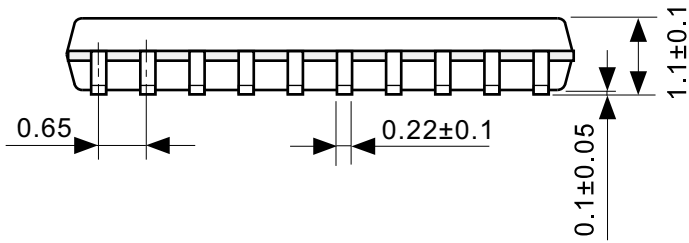
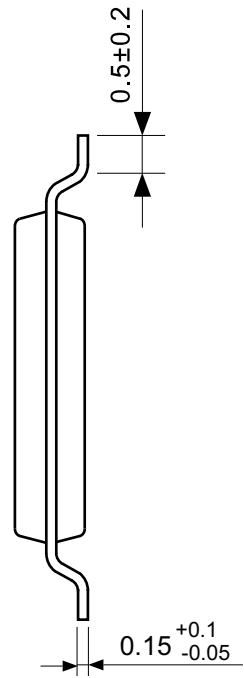
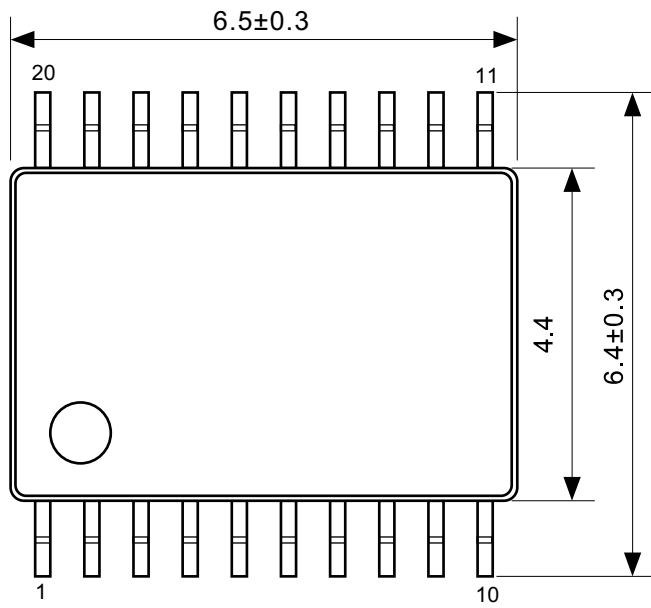

No. FT020-B-P-SD-1.0

TITLE	TSSOP20-B-PKG Dimensions
No.	FT020-B-P-SD-1.0
ANGLE	
UNIT	mm
ABLIC Inc.	

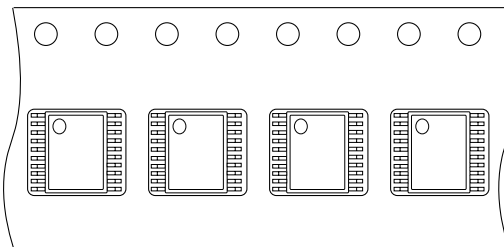
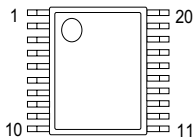
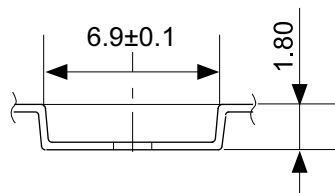
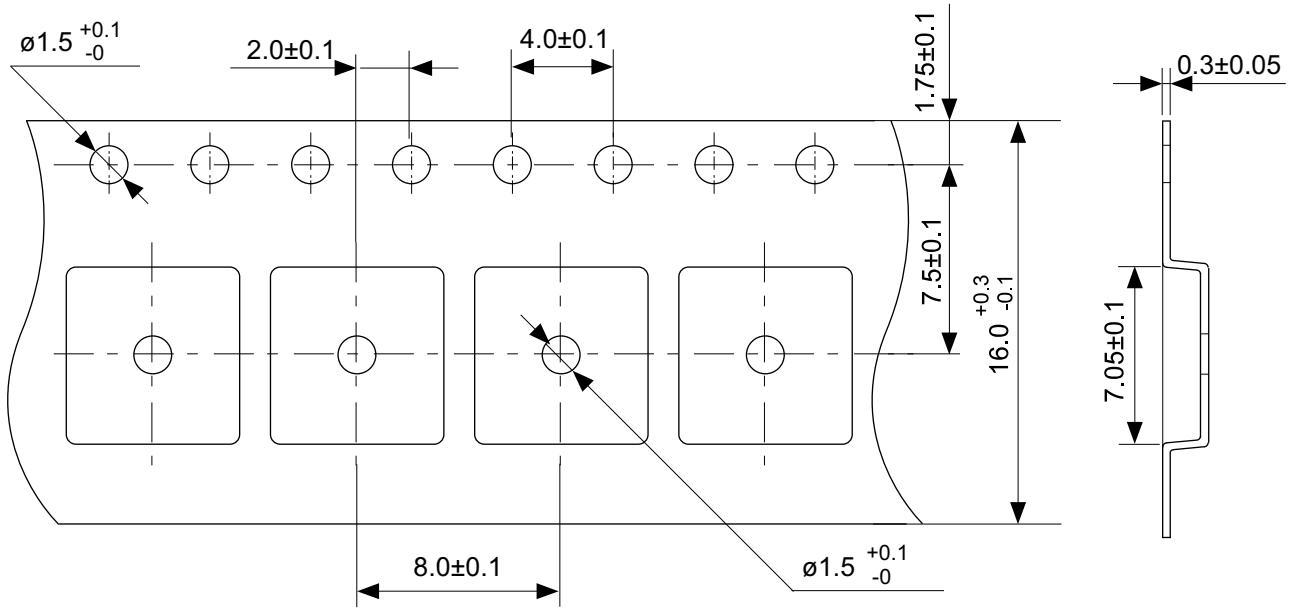

→
Feed direction

No. FT020-B-C-SD-1.0

TITLE	TSSOP20-B-Carrier Tape
No.	FT020-B-C-SD-1.0
ANGLE	
UNIT	mm
ABLIC Inc.	

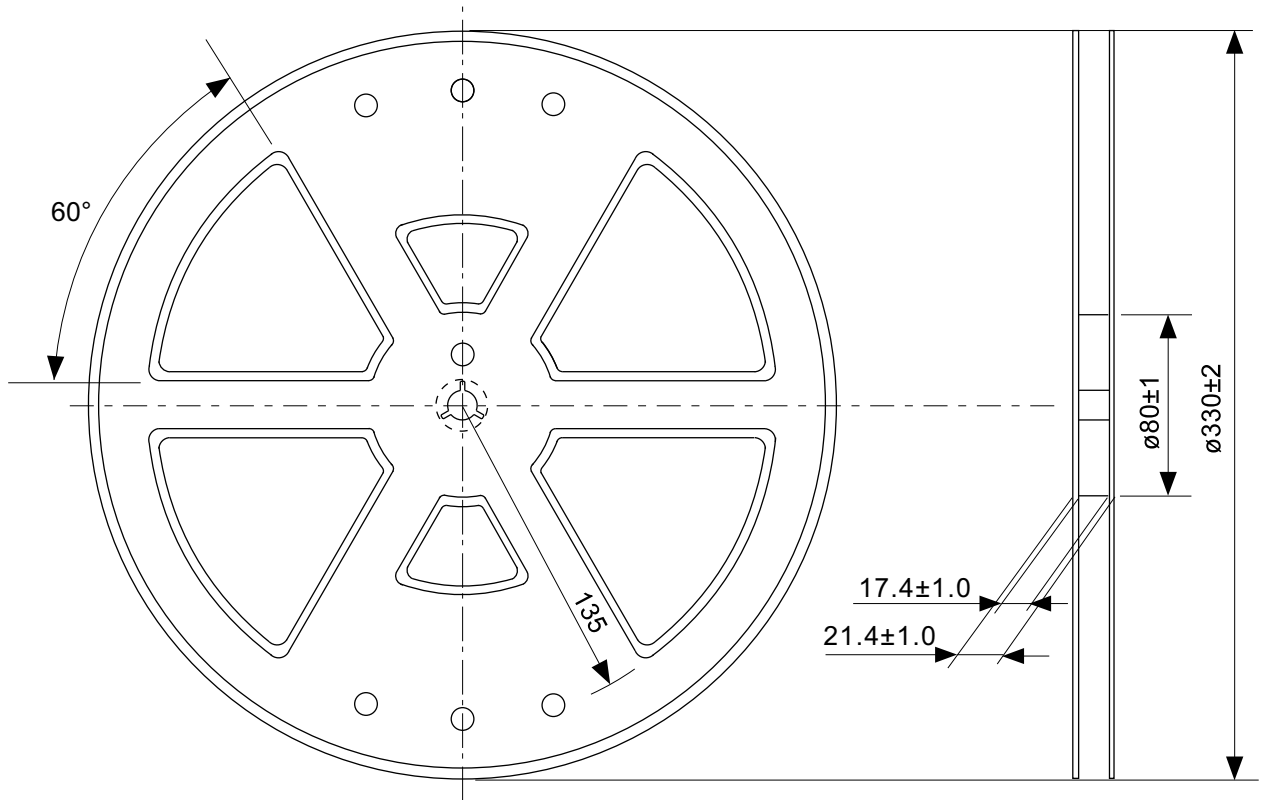

Enlarged drawing in the central part

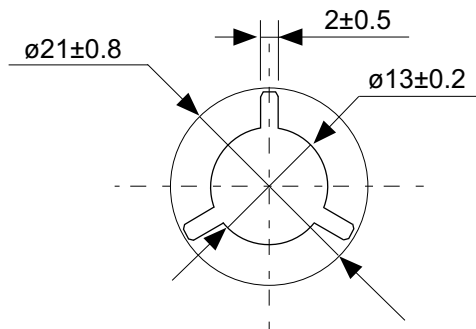

No. FT020-B-R-SD-1.0

TITLE	TSSOP20-B-Reel		
No.	FT020-B-R-SD-1.0		
ANGLE		QTY.	4.000
UNIT	mm		
ABLIC Inc.			

Disclaimers (Handling Precautions)

1. All the information described herein (product data, specifications, figures, tables, programs, algorithms and application circuit examples, etc.) is current as of publishing date of this document and is subject to change without notice.
2. The circuit examples and the usages described herein are for reference only, and do not guarantee the success of any specific mass-production design.
ABLIC Inc. is not responsible for damages caused by the reasons other than the products described herein (hereinafter "the products") or infringement of third-party intellectual property right and any other right due to the use of the information described herein.
3. ABLIC Inc. is not responsible for damages caused by the incorrect information described herein.
4. Be careful to use the products within their specified ranges. Pay special attention to the absolute maximum ratings, operation voltage range and electrical characteristics, etc.
ABLIC Inc. is not responsible for damages caused by failures and / or accidents, etc. that occur due to the use of the products outside their specified ranges.
5. When using the products, confirm their applications, and the laws and regulations of the region or country where they are used and verify suitability, safety and other factors for the intended use.
6. When exporting the products, comply with the Foreign Exchange and Foreign Trade Act and all other export-related laws, and follow the required procedures.
7. The products must not be used or provided (exported) for the purposes of the development of weapons of mass destruction or military use. ABLIC Inc. is not responsible for any provision (export) to those whose purpose is to develop, manufacture, use or store nuclear, biological or chemical weapons, missiles, or other military use.
8. The products are not designed to be used as part of any device or equipment that may affect the human body, human life, or assets (such as medical equipment, disaster prevention systems, security systems, combustion control systems, infrastructure control systems, vehicle equipment, traffic systems, in-vehicle equipment, aviation equipment, aerospace equipment, and nuclear-related equipment), excluding when specified for in-vehicle use or other uses. Do not apply the products to the above listed devices and equipments without prior written permission by ABLIC Inc. Especially, the products cannot be used for life support devices, devices implanted in the human body and devices that directly affect human life, etc.
Prior consultation with our sales office is required when considering the above uses.
ABLIC Inc. is not responsible for damages caused by unauthorized or unspecified use of our products.
9. Semiconductor products may fail or malfunction with some probability.
The user of the products should therefore take responsibility to give thorough consideration to safety design including redundancy, fire spread prevention measures, and malfunction prevention to prevent accidents causing injury or death, fires and social damage, etc. that may ensue from the products' failure or malfunction.
The entire system must be sufficiently evaluated and applied on customer's own responsibility.
10. The products are not designed to be radiation-proof. The necessary radiation measures should be taken in the product design by the customer depending on the intended use.
11. The products do not affect human health under normal use. However, they contain chemical substances and heavy metals and should therefore not be put in the mouth. The fracture surfaces of wafers and chips may be sharp. Be careful when handling these with the bare hands to prevent injuries, etc.
12. When disposing of the products, comply with the laws and ordinances of the country or region where they are used.
13. The information described herein contains copyright information and know-how of ABLIC Inc.
The information described herein does not convey any license under any intellectual property rights or any other rights belonging to ABLIC Inc. or a third party. Reproduction or copying of the information from this document or any part of this document described herein for the purpose of disclosing it to a third-party without the express permission of ABLIC Inc. is strictly prohibited.
14. For more details on the information described herein, contact our sales office.

2.2-2018.06