

**PWM STEP-UP SWITCHING REGULATOR
WITH VOLTAGE DETECTORS**

S-8310/8311 Series

The 8310/8311 Series includes a CMOS PWM step-up switching regulator that consists of a reference voltage source, a CR oscillation circuit, a power MOS FET and two voltage detectors. Output voltage is fixed internally and a shutdown function is available. Current consumption is drastically reduced because of the CMOS configuration. The 8310/8311 Series offers low voltage operation. The S-8310 Series easily forms a step-up switching regulator by attaching only a coil, a diode and capacitors externally. The S-8311 Series has a function of input voltage clamp. Both series are suitable for use as power sources for portable devices.

■ **Features**

- Low voltage operation: 0.9 V min.
- Low current consumption: 23 μ A typ. (S-8310AFE, ISS)
- High-precision output voltage: $\pm 2.4\%$
- Shutdown function
- Two voltage detectors
- Internal switching current limit circuit
- Adjustable voltage clamp circuit (S-8311)
- SOP-8, SSOP-16 package

■ **Applications**

- Power supplies for portable equipment such as pagers, handy calculators, and remote controllers
- Constant voltage power supplies for cameras, video equipment, and communications equipment
- Power supply for microcomputers

■ **Block Diagram**

(1) S-8310 Series

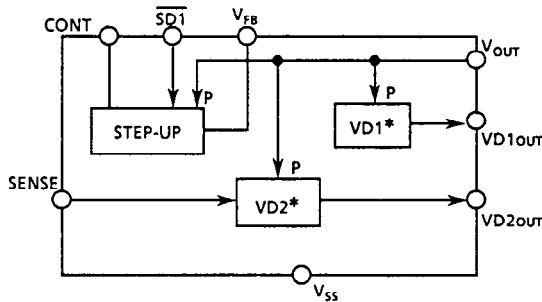

(2) S-8311 Series

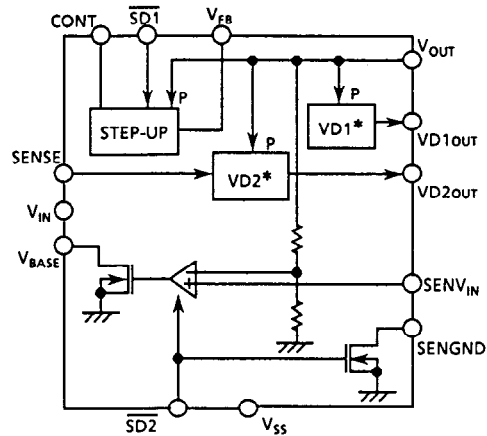

- * The two voltage detectors have Nch open-drain.
- * P means a power line.

Figure 1 Block Diagram

PWM STEP-UP SWITCHING REGULATOR WITH VOLTAGE DETECTORS

S-8310/8311 Series

■ Selection Guide

1. Name of the Product

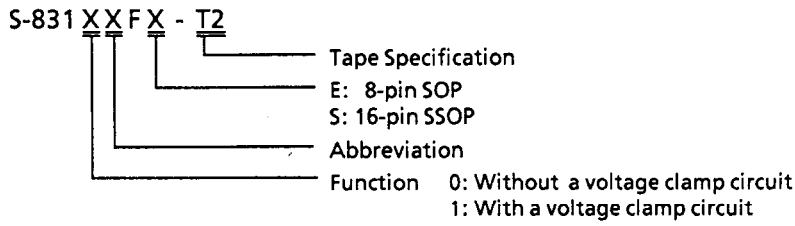

2. List of the Product

Name	Item	Output Voltage (V)	Detection Voltage VD1 (V)	Detection Voltage VD2 (V)
S-8310AFE		3.00	2.20	0.90
S-8310BFE		2.50	2.20	0.80
S-8310CFE		3.00	2.20	1.10
S-8310DFE		2.70	2.20	1.00
S-8311AF5		2.00	1.90	0.95

Note 1: Voltage values shown above are typical.

Note 2: For other values, contact SII's or SIU's IC Sales Dept.

■ Pin Assignment

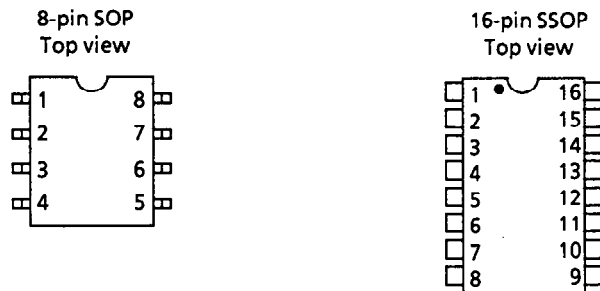

Figure 2

Pin name	S-8310	S-8311	Functions
CONT	8	16	External inductor connection terminal
V _{SS}	1	1	GND terminal
$\overline{SD1}$	2	3	Shutdown terminal for Step-up "H": Operation "L": Step-up stop
V _{FB}	6	13	Feedback voltage terminal for step-up
V _{OUT}	7	14	Positive power terminal for voltage detectors, step-up and clamp circuit
VD1 _{OUT}	5	9	Output terminal for VD1
SENSE	3	6	Sensing terminal for Voltage Detector 2 (VD2)
VD2 _{OUT}	4	7	Output terminal for VD2
V _{IN}	—	12	Sensing terminal for clamp circuit
V _{BASE}	—	10	External transistor connection terminal
SENV _{IN}	—	11	Sensing terminal for primary battery
$\overline{SD2}$	—	4	Shutdown terminal for voltage clamp "H": Clamp operation "L": Stop
SENGND	—	5	External resistors connection terminal

Note: In the S-8311 Series, pin Nos. 2, 8, and 15 are NC.

PWM STEP-UP SWITCHING REGULATOR WITH VOLTAGE DETECTORS
S-8310/8311 Series

■ **Absolute Maximum Ratings**

(Unless otherwise specified Ta = 25°C)

Parameter	Symbol	Ratings	Unit
Input voltage	SENSE, CONT, V_{OUT} , V_{BASE} SENV _{IN} , SENGND, SD1, SD2, V _{FB}	$V_{SS} - 0.3$ to 10	V
Output voltage of VD1 and VD2	VD1 _{OUT} , VD2 _{OUT}	$V_{SS} - 0.3$ to 10	V
Supply voltage	V _{IN}	$V_{SS} - 0.3$ to 10	V
Power dissipation	P _D	300	mW
Operating temperature	T _{opr}	- 40 to + 85	°C
Storage temperature	T _{stg}	- 40 to + 125	°C

■ **Electrical Characteristics**

1. S-8310AFE

(Unless otherwise specified Ta = 25°C)

Parameter	Symbol	Conditions	Min.	Typ.	Max.	Unit.	Test
Current consumption	I _{SS}	V _{OUT} = 2.85V, $\overline{SD1} = V_{OUT}$	—	23	35	μA	1
	I _{ST}	V _{OUT} = 2.85V, $\overline{SD1} = GND$	—	2.1	4		
Output voltage	V _{OUT}	V _{IN} = 1.5V, I _{OUT} = 10mA	2.928	3	3.072	V	2
Start-up voltage	V _{st}	R _L = V _{OUT} /1mA, V _{IN} voltage	—	—	0.9		
Retention voltage	V _{hld}	R _L = V _{OUT} /1mA, V _{IN} voltage	0.7	—	—		
Line regulation	$\Delta V_{OUT}(V_{IN})$	V _{IN} = 1.5~2.0V, I _{OUT} = 10mA	—	2	20		
Load regulation	$\Delta V_{OUT}(I_{OUT})$	V _{IN} = 1.5V, I _{OUT} = 10μA~15mA	—	2	25		
Output voltage temperature coefficient	$\Delta V_{OUT} / \Delta T_a$	Ta = -40 to + 85°C	—	± 0.31	± 1.31	mV/°C	
Oscillating frequency	f _{osc}	V _{OUT} = 3V, FB = GND	40	50	60	KHz	3
Maximum duty ratio	maxduty	V _{OUT} = 3V, FB = GND	65	75	85	%	
Shutdown terminal input voltage	V _{SH}	Operation	2.1	—	8	V	
	V _{SL}	Shut down	V _{SS} -0.3V	—	0.75		
Leakage current	I _{lek}	CONT = 8V, $\overline{SD1} = GND$	—	—	1.0	μA	4
Switch current	I _{sw}	CONT = 0.5V	120	170	—	mA	—
VD1 Detection voltage	-VDET1		2.147	2.2	2.253	V	5
Hysteresis width of VD1	hys1		3	4.5	6	%	
VD1 Detection voltage temperature coefficient	$\Delta -VDET1 / \Delta T_a$	Ta = -40 to + 85°C	—	± 0.23	± 0.96	mV/°C	
VD1 Output current (Nch)	I _{SINK1}	V _{OUT} = 1.3V, VD1 _{OUT} = 0.5V	900	—	—	μA	6
Operating voltage of VD1	V _{dd1}	$\overline{SD1} = GND$	0.7	—	8	V	5
VD2 Detection voltage	-VDET2	V _{OUT} = 3V	0.878	0.900	0.922		
Hysteresis width of VD2	hys2	V _{OUT} = 3V	2	—	10	%	7
VD2 Detection voltage temperature coefficient	$\Delta -VDET2 / \Delta T_a$	Ta = -40 to + 85°C	—	± 0.09	± 0.39	mV/°C	
VD2 Output current (Nch)	I _{SINK2}	V _{OUT} = 1.3V, VD2 _{OUT} = 0.5V SENSE = GND	900	—	—	μA	8
Operating voltage of VD2	V _{dd2}	$\overline{SD1} = GND$	1.3	—	8	V	7

Coil: CD54 (220 μH) by Sumida Electric Co., Ltd.

Diode: MA729 by Matsushita Electronic Components Co., Ltd., C_{in} = C_{OUT} = 10μF Tantalum

PWM STEP-UP SWITCHING REGULATOR WITH VOLTAGE DETECTORS

S-8310/8311 Series

2. S-8310BFE

(Unless otherwise specified Ta = 25°C)

Parameter	Symbol	Conditions	Min.	Typ.	Max.	Unit.	Test
Current consumption	ISS	V _{OUT} = 2.375V, $\overline{SD1} = V_{OUT}$	—	20	30	μA	1
	IST	V _{OUT} = 2.375V, $\overline{SD1} = GND$	—	2.1	4		
Output voltage	V _{OUT}	V _{IN} = 1.5V, I _{OUT} = 10mA	2.440	2.5	2.560	V	2
Start-up voltage	V _{st}	R _L = V _{OUT} /1mA, V _{IN} voltage	—	—	0.9		
Retention voltage	V _{hid}	R _L = V _{OUT} /1mA, V _{IN} voltage	0.7	—	—		
Line regulation	ΔV _{OUT} (V _{IN})	V _{IN} = 1.5~2.0V, I _{OUT} = 10mA	—	2	18	mV	2
Load regulation	ΔV _{OUT} (I _{OUT})	V _{IN} = 1.5V, I _{OUT} = 10μA~15mA	—	2	23		
Output voltage temperature coefficient	ΔV _{OUT} /ΔTa	Ta = -40 to +85°C	—	±0.26	±1.09	mV/°C	
Oscillating frequency	fosc	V _{OUT} = 2.5V, FB = GND	40	50	60	KHz	3
Maximum duty ratio	maxduty	V _{OUT} = 2.5V, FB = GND	65	75	85	%	
Shutdown terminal input voltage	V _{SH}	Operation	1.8	—	8	V	
	V _{SL}	Shut down	V _{SS} -0.3V	—	0.7		
Leakage current	I _{lek}	CONT = 8V, $\overline{SD1} = GND$	—	—	1.0	μA	4
Switch current	I _{sw}	CONT = 0.5V	97	140	—	mA	—
VD1 Detection voltage	-VDET1		2.147	2.2	2.253	V	5
Hysteresis width of VD1	hys1		3	4.5	6	%	
VD1 Detection voltage temperature coefficient	Δ-VDET1/ΔTa	Ta = -40 to +85°C	—	±0.23	±0.96	mV/°C	
VD1 Output current (Nch)	ISINK1	V _{OUT} = 1.3V, VD1 _{OUT} = 0.5V	900	—	—	μA	6
Operating voltage of VD1	vdd1	$\overline{SD1} = GND$	0.7	—	8	V	5
VD2 Detection voltage	-VDET2	V _{OUT} = 2.5V	0.780	0.800	0.820		
Hysteresis width of VD2	hys2	V _{OUT} = 2.5V	2	—	10	%	
VD2 Detection voltage temperature coefficient	Δ-VDET2/ΔTa	Ta = -40 to +85°C	—	±0.08	±0.35	mV/°C	
VD2 Output current (Nch)	ISINK2	V _{OUT} = 1.3V, VD2 _{OUT} = 0.5V SENSE = GND	900	—	—	μA	8
Operating voltage of VD2	vdd2	$\overline{SD1} = GND$	1.3	—	8	V	7

Coil: CD54 (220 μH) by Sumida Electric Co., Ltd.

Diode: MA729 by Matsushita Electronic Components Co., Ltd., C_{in} = C_{OUT} = 10μF Tantalum

PWM STEP-UP SWITCHING REGULATOR WITH VOLTAGE DETECTORS
S-8310/8311 Series

- 3. S-8310CFE

(Unless otherwise specified Ta = 25°C)

Parameter	Symbol	Conditions	Min.	Typ.	Max.	Unit.	Test
Current consumption	ISS	V _{OUT} = 2.85V, $\overline{SD1} = V_{OUT}$	—	23	35	μA	1
	IST	V _{OUT} = 2.85V, $\overline{SD1} = GND$	—	2.1	4		
Output voltage	V _{OUT}	V _{IN} = 1.5V, I _{OUT} = 10mA	2.928	3	3.072	V	2
Start-up voltage	V _{st}	R _L = V _{OUT} /1mA, V _{IN} voltage	—	—	0.9		
Retention voltage	V _{hld}	R _L = V _{OUT} /1mA, V _{IN} voltage	0.7	—	—		
Line regulation	ΔV _{OUT} (V _{IN})	V _{IN} = 1.5~2.0V, I _{OUT} = 10mA	—	2	20	mV	2
Load regulation	ΔV _{OUT} (I _{OUT})	V _{IN} = 1.5V, I _{OUT} = 10μA~15mA	—	2	25		
Output voltage temperature coefficient	ΔV _{OUT} /ΔTa	Ta = -40 to +85°C	—	± 0.31	± 1.31	mV/°C	
Oscillating frequency	f _{osc}	V _{OUT} = 3V, FB = GND	40	50	60	KHz	3
Maximum duty ratio	maxduty	V _{OUT} = 3V, FB = GND	65	75	85	%	
Shutdown terminal input voltage	V _{SH}	Operation	2.1	—	8	V	
	V _{SL}	Shut down	V _{SS} -0.3V	—	0.75		
Leakage current	I _{lek}	CONT = 8V, $\overline{SD1} = GND$	—	—	1.0	μA	4
Switch current	I _{sw}	CONT = 0.5V	120	170	—	mA	—
VD1 Detection voltage	-VDET1		2.147	2.2	2.253	V	5
Hysteresis width of VD1	hys1		3	4.5	6	%	
VD1 Detection voltage temperature coefficient	Δ-VDET1/ΔTa	Ta = -40 to +85°C	—	± 0.23	± 0.96	mV/°C	
VD1 Output current (Nch)	ISINK1	V _{OUT} = 1.3V, VD1 _{OUT} = 0.5V	900	—	—	μA	6
Operating voltage of VD1	v _{dd1}	$\overline{SD1} = GND$	0.7	—	8	V	5
VD2 Detection voltage	-VDET2	V _{OUT} = 3V	1.073	1.100	1.127		
Hysteresis width of VD2	hys2	V _{OUT} = 3V	2	—	10	%	
VD2 Detection voltage temperature coefficient	Δ-VDET2/ΔTa	Ta = -40 to +85°C	—	± 0.11	± 0.48	mV/°C	
VD2 Output current (Nch)	ISINK2	V _{OUT} = 1.3V, VD2 _{OUT} = 0.5V SENSE = GND	900	—	—	μA	8
Operating voltage of VD2	v _{dd2}	$\overline{SD1} = GND$	1.3	—	8	V	7

Coil: CD54 (220 μH) by Sumida Electric Co., Ltd.

Diode: MA729 by Matsushita Electronic Components Co., Ltd., C_{in} = C_{OUT} = 10μF Tantalum

PWM STEP-UP SWITCHING REGULATOR WITH VOLTAGE DETECTORS

S-8310/8311 Series

4. S-8310DFE

(Unless otherwise specified Ta = 25°C)

Parameter	Symbol	Conditions	Min.	Typ.	Max.	Unit.	Test
Current consumption	I _{SS}	V _{OUT} = 2.565V, $\overline{SD1} = V_{OUT}$	—	21	32	μA	1
	I _{ST}	V _{OUT} = 2.565V, $\overline{SD1} = GND$	—	2.1	4		
Output voltage	V _{OUT}	V _{IN} = 1.5V, I _{OUT} = 10mA	2.635	2.7	2.765	V	2
Start-up voltage	V _{st}	R _L = V _{OUT} /1mA, V _{IN} voltage	—	—	0.9		
Retention voltage	V _{hld}	R _L = V _{OUT} /1mA, V _{IN} voltage	0.7	—	—		
Line regulation	ΔV _{OUT} (V _{IN})	V _{IN} = 1.5~2.0V, I _{OUT} = 10mA	—	2	19	mV	2
Load regulation	ΔV _{OUT} (I _{OUT})	V _{IN} = 1.5V, I _{OUT} = 10μA~15mA	—	2	24		
Output voltage temperature coefficient	ΔV _{OUT} /ΔTa	Ta = -40 to +85°C	—	±0.28	±1.17	mV/°C	
Oscillating frequency	f _{osc}	V _{OUT} = 3V, FB = GND	40	50	60	KHz	3
Maximum duty ratio	maxduty	V _{OUT} = 3V, FB = GND	65	75	85	%	
Shutdown terminal input voltage	V _{SH}	Operation	2.0	—	8	V	
	V _{SL}	Shut down	V _{SS} -0.3V	—	0.7		
Leakage current	I _{lek}	CONT = 8V, $\overline{SD1} = GND$	—	—	1.0	μA	4
Switch current	I _{sw}	CONT = 0.5V	106	152	—	mA	—
VD1 Detection voltage	-VDET1		2.147	2.2	2.253	V	5
Hysteresis width of VD1	hys1		3	4.5	6	%	
VD1 Detection voltage temperature coefficient	Δ-VDET1/ΔTa	Ta = -40 to +85°C	—	±0.23	±0.96	mV/°C	
VD1 Output current (Nch)	I _{SINK1}	V _{OUT} = 1.3V, VD1 _{OUT} = 0.5V	900	—	—	μA	6
Operating voltage of VD1	v _{dd1}	$\overline{SD1} = GND$	0.7	—	8	V	5
VD2 Detection voltage	-VDET2	V _{OUT} = 2.7V	0.976	1.000	1.024		
Hysteresis width of VD2	hys2	V _{OUT} = 2.7V	2	—	10	%	
VD2 Detection voltage temperature coefficient	Δ-VDET2/ΔTa	Ta = -40 to +85°C	—	±0.10	±0.44	mV/°C	
VD2 Output current (Nch)	I _{SINK2}	V _{OUT} = 1.3V, VD2 _{OUT} = 0.5V SENSE = GND	900	—	—	μA	8
Operating voltage of VD2	v _{dd2}	$\overline{SD1} = GND$	1.3	—	8	V	7

Coil: CD54 (220 μH) by Sumida Electric Co., Ltd.

Diode: MA729 by Matsushita Electronic Components Co., Ltd., C_{in} = C_{OUT} = 10μF Tantalum

PWM STEP-UP SWITCHING REGULATOR WITH VOLTAGE DETECTORS
S-8310/8311 Series

- 5. S-8311AFS

(Unless otherwise Ta = 25°C)

Parameter	Symbol	Conditions	Min.	Typ.	Max.	Unit.	Test
Current consumption	ISS	$V_{OUT} = 1.9V$ $\overline{SD1} = V_{OUT}, \overline{SD2} = GND$	—	16	25	μA	1
	ISSC	$V_{OUT} = 1.9V$ $\overline{SD1} = V_{OUT}, \overline{SD2} = V_{OUT}$	—	60	85		
	IST	$V_{OUT} = 1.9V$ $\overline{SD1} = GND, \overline{SD2} = GND$	—	2.1	4		
Output voltage	V_{OUT}	$V_{IN} = 1.5V, I_{OUT} = 10mA$	1.952	2.000	2.048	V	2
Start-up voltage	V_{st}	$R_L = V_{OUT}/1mA, V_{IN}$ voltage	—	—	0.9		
Retention voltage	V_{hid}	$R_L = V_{OUT}/1mA, V_{IN}$ voltage	0.7	—	—		
Line regulation	$\Delta V_{OUT}(V_{IN})$	$V_{IN} = 1.5 \sim 2.0V, I_{OUT} = 10mA$	—	2	15	mV	2
Load regulation	$\Delta V_{OUT}(I_{OUT})$	$V_{IN} = 1.5V, I_{OUT} = 10\mu A \sim 15mA$	—	2	20		
Output voltage temperature coefficient	$\Delta V_{OUT} / \Delta Ta$	$Ta = -40 \sim +85^\circ C$	—	± 0.21	± 0.87	mV/°C	
Oscillating frequency	fosc	$V_{OUT} = 2V, FB = GND$	40	50	60	KHz	3
Maximum duty ratio	maxduty	$V_{OUT} = 2V, FB = GND$	65	75	85		
Shutdown terminal input voltage	V_{SH}	Operation	1.5	—	8	V	3
	V_{SL}	Shut down	$V_{SS}-0.3V$	—	0.55		
Leakage current	I_{lek}	$CONT = 8V, \overline{SD1} = GND$	—	—	1.0	μA	4
Switch current	I_{sw}	$CONT = 0.5V$	75	115	—	mA	—
VD1 Detection voltage	-VDET1	$\overline{SD1} = GND$	1.740	1.787	1.831	V	5
Hysteresis width of VD1	hys1	$\overline{SD1} = GND$	3	4.5	6		
VD1 Detection voltage temperature coefficient	$\Delta -VDET1 / \Delta Ta$	$Ta = -40 \sim +85^\circ C$	—	± 0.18	± 0.78	mV/°C	
VD1 Output current (Nch)	ISINK1	$V_{OUT} = 1.3V, VD1_{OUT} = 0.5V$	900	—	—	μA	6
Operating voltage of VD1	vdd1	$\overline{SD1} = GND$	0.7	—	8	V	5
VD2 Detection voltage	-VDET2	$\overline{SD1} = GND$	0.927	0.950	0.973		
Hysteresis width of VD2	hys2	$\overline{SD1} = GND$	2	—	10	%	7
VD2 Detection voltage temperature coefficient	$\Delta -VDET2 / \Delta Ta$	$Ta = -40 \sim +85^\circ C$	—	± 0.10	± 0.41		
VD2 Output current (Nch)	ISINK2	$V_{OUT} = 1.3V, VD2_{OUT} = 0.5V$ $V_{SENSE} = GND$	900	—	—	μA	8
Operating voltage of VD2	vdd2	$\overline{SD1} = GND$	1.3	—	8	V	7
Clamp reference voltage	V_{INREF}	$V_{IN} = 1.5V$ $\overline{SD1} = V_{OUT}, \overline{SD2} = V_{OUT}$	0.731	0.778	0.825		

Coil: CD54 (220 μH) by Sumida Electric Co., Ltd.

Diode: MA729 by Matsushita Electronic Components Co., Ltd., $C_{in} = C_{OUT} = 10\mu F$ Tantalum

PWM STEP-UP SWITCHING REGULATOR WITH VOLTAGE DETECTORS

S-8310/8311 Series

Test Circuits

1.

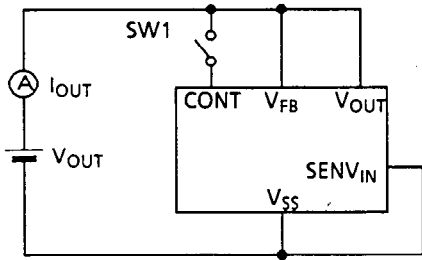

Turn ON SW1 at the IST test.

2.

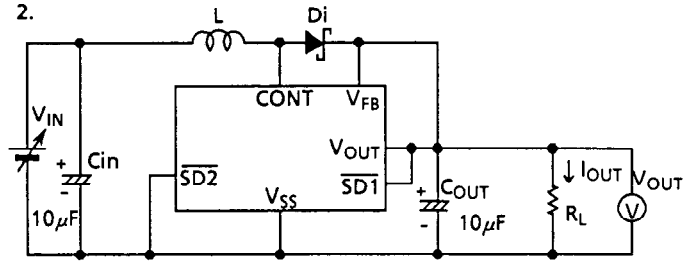

Vst: V_{IN} when 90% of V_{OUT} are output at the rising of V_{IN} .
Vhld: V_{IN} when 90% of V_{OUT} are output at the falling of V_{IN} .

3.

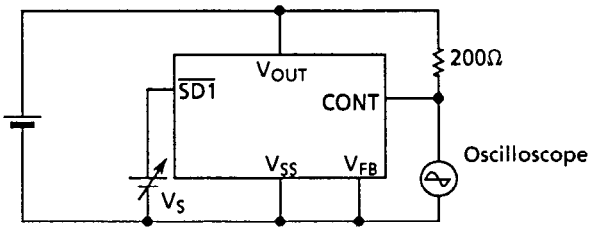

4.

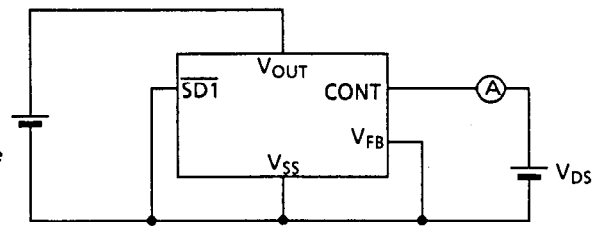

5.

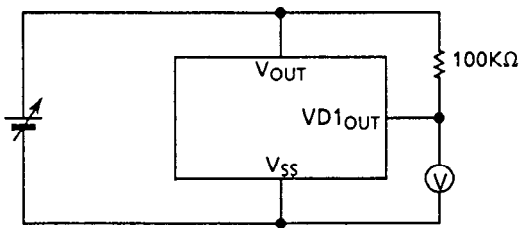

6.

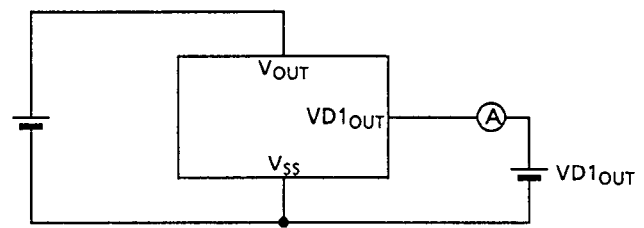

7.

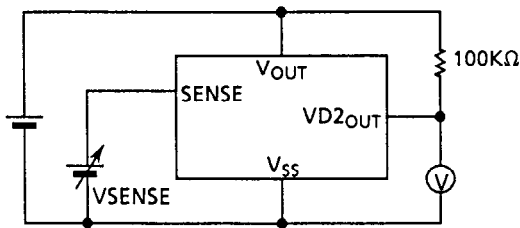

8.

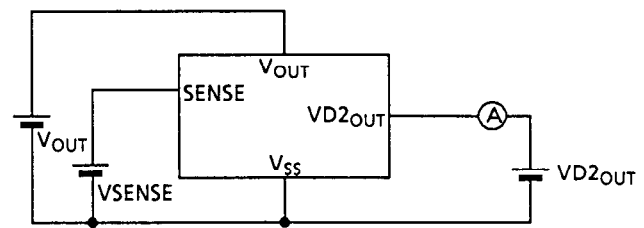

9.

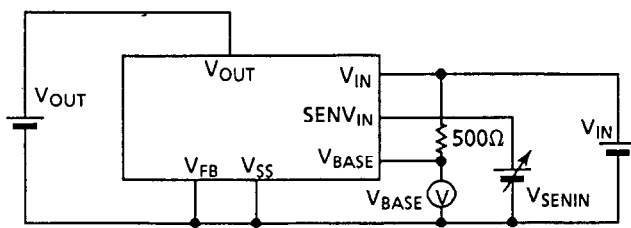

V_{INREF} : V_{SENIN} when V_{BASE} output changes.

Figure 3

■ **Operation**

1. Step-Up Regulator

The step-up regulator consists of a power MOS EFT, a CR oscillation circuit and an error amplifier.

M1 is turned ON or OFF by the CR oscillation circuit. When M1 is turned ON (t_{ON}), the energy is stored in the inductor (L); when M1 is turned OFF (t_{OFF}), the stored energy is supplied via the diode to the capacitor (C_{OUT}) of V_{OUT} (see Figure 4).

The V_{OUT} output voltage can be selected between 1.8V and 3.6V by 0.1V step.

$\overline{SD1}$ pin: Stops or starts step-up operation. M1 is turned OFF.

When turning $\overline{SD1}$ pin low, all of internal circuits stop their operation. This allows the current consumption to be reduced drastically. DO NOT use the $\overline{SD1}$ terminal in floating state because of no internal pulling-up and -down.

Shut-down pin	CR oscillation circuit	Output voltage
"H"	Operation	Fixed
"L"	Stop	$\approx V_{IN}^*$

* Voltage obtained by extracting the voltage drop due to DC resistance of the inductor, and the diode forward voltage from V_{IN}

The following are basic equations [(1) through (7)] of the step-up switching regulator (see Figure 4).

Current I_L flowing into L is zero the moment M1 is turned ON:

$$V_A = V_S \dots\dots\dots (1)$$

(V_S : Non-saturated voltage of M1)

The change in I_L over time:

$$\frac{dI_L}{dt} = \frac{V_L}{L} = \frac{V_{IN} - V_S}{L} \dots\dots\dots (2)$$

Integration of the above equation (I_L):

$$I_L = \left(\frac{V_{IN} - V_S}{L} \right) \cdot t \dots\dots\dots (3)$$

I_L flows when M1 is turned ON (t_{ON}). The time is determined by the oscillation frequency of the OSC.

The peak current (I_{PK}) after M1 is turned ON (t_{ON}):

$$I_{PK} = \left(\frac{V_{IN} - V_S}{L} \right) \cdot t_{ON} \dots\dots\dots (4)$$

The energy stored in L is represented with $\frac{1}{2}L(I_{PK})^2$.

When M1 is turned OFF (t_{OFF}), the energy stored in L is transmitted through a diode to the output capacitor. Then reverse voltage (V_L) is output.

$$V_L = (V_{OUT} + V_D) - V_{IN} \dots\dots\dots (5)$$

(V_D : Diode forward voltage)

The voltage at CONT pin rises only by the voltage corresponding to $V_{OUT} + V_D$.

When M1 is turned OFF (t_{OFF}), the current flowing through the diode into V_{OUT} changes as follows:

$$\frac{dI_L}{dt} = \frac{V_L}{L} = \frac{V_{OUT} + V_D - V_{IN}}{L} \dots\dots\dots (6)$$

PWM STEP-UP SWITCHING REGULATOR WITH VOLTAGE DETECTORS

S-8310/8311 Series

Integration of the above equation is as follows:

$$I_L = I_{PK} - \left(\frac{V_{OUT} + V_D - V_{IN}}{L} \right) \cdot t \dots\dots\dots (7)$$

When M1 is turned ON (t_{ON}), the energy is stored in L and is not transmitted to V_{OUT} . When receiving output current (I_{OUT}) from V_{OUT} , the energy of the capacitor (C_{OUT}) is consumed. As a result, the pin voltage of C_{OUT} is reduced, and goes to the lowest level after M1 is turned ON (t_{ON}). When M1 is turned OFF, the energy stored in L is transmitted through the diode to C_{OUT} , and the voltage of C_{OUT} rises drastically. V_{OUT} is a time function that indicates the maximum value (ripple voltage V_{P-P}) when the current flowing through the diode into V_{OUT} and load current (I_{OUT}) match.

Next, the ripple voltage is found out as follows:

I_{OUT} vs t_1 (time) from when M1 is turned ON (t_{ON}) to when V_{OUT} reaches the maximum level:

$$I_{OUT} = I_{PK} - \left(\frac{V_{OUT} + V_D - V_{IN}}{L} \right) \cdot t_1 \dots\dots\dots (8)$$

$$\therefore t_1 = (I_{PK} - I_{OUT}) \cdot \left(\frac{L}{V_{OUT} + V_D - V_{IN}} \right) \dots\dots\dots (9)$$

When M1 is turned OFF (t_{OFF}), $I_L = 0$ (when the energy of the inductor is completely consumed). Based on equation (7),

$$\left(\frac{L}{V_{OUT} + V_D - V_{IN}} \right) = \frac{t_{OFF}}{I_{PK}} \dots\dots\dots (10)$$

When substituting equation (10) for equation (9),

$$t_1 = t_{OFF} - \left(\frac{I_{OUT}}{I_{PK}} \right) \cdot t_{OFF} \dots\dots\dots (11)$$

Electric charge ΔQ_1 which is charged in C_{OUT} during t_1 :

$$\begin{aligned} \Delta Q_1 &= \int_0^{t_1} I_L dt = I_{PK} \cdot \int_0^{t_1} dt - \frac{V_{OUT} + V_D - V_{IN}}{L} \cdot \int_0^{t_1} t dt \\ &= I_{PK} \cdot t_1 - \frac{V_{OUT} + V_D - V_{IN}}{L} \cdot \frac{1}{2} t_1^2 \dots\dots\dots (12) \end{aligned}$$

When substituting equation (9) for equation (12):

$$\Delta Q_1 = I_{PK} - \frac{1}{2} (I_{PK} - I_{OUT}) \cdot t_1 = \frac{I_{PK} + I_{OUT}}{2} \cdot t_1 \dots\dots\dots (13)$$

A rise in voltage (V_{P-P}) due to ΔQ_1 :

$$V_{P-P} = \frac{\Delta Q_1}{C_{OUT}} = \frac{1}{C_{OUT}} \cdot \left(\frac{I_{PK} + I_{OUT}}{2} \right) \cdot t_1 \dots\dots\dots (14)$$

When taking into consideration I_{OUT} to be consumed during t_1 :

$$V_{P-P} = \frac{\Delta Q_1}{C_{OUT}} = \frac{1}{C_{OUT}} \cdot \left(\frac{I_{PK} + I_{OUT}}{2} \right) \cdot t_1 - \frac{I_{OUT} \cdot t_1}{C_{OUT}} \dots\dots\dots (15)$$

When substituting equation (15) for equation (11):

$$V_{P-P} = \frac{(I_{PK} - I_{OUT})^2}{2 I_{PK}} \cdot \frac{t_{OFF}}{C_{OUT}} \dots\dots\dots (16)$$

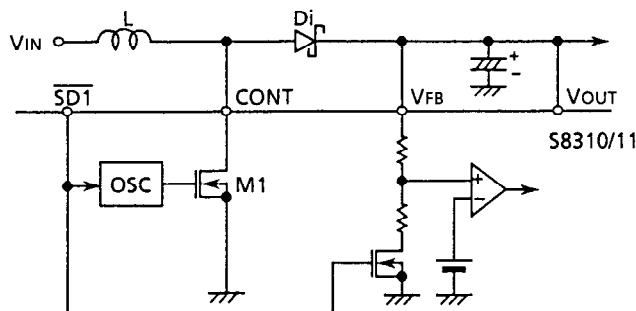

Figure 4

2. Voltage Detectors (VD1, VD2)

The S-8310/8311 Series has two voltage detectors.

The power of the voltage detectors is supplied from V_{OUT} . When V_{OUT} is below the operating voltage V_{dd1} and V_{dd2} , the voltage detector does not function normally. The detectors function regardless of $\overline{SD1}$ or $\overline{SD2}$.

Detector VD1 internally monitors the voltage of V_{OUT} . Detector VD2 can detect any voltage by connecting the SENSE terminal (see Figure 5). The VD1 detection voltage can be selected between 1.5V and 3.2V by 0.1V step. The VD2 detection voltage can be selected between 0.8V and 2.0V by 0.1V step.

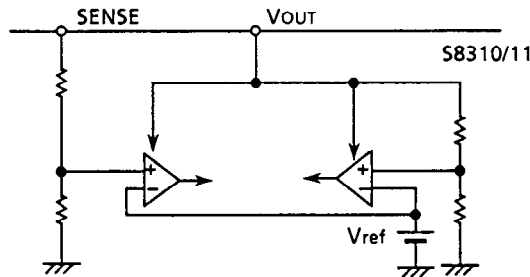

Figure 5

3. Voltage Clamp Circuit

The built-in voltage clamp circuit in the S-8311 Series prevents a drop in the battery voltage caused by large current and internal resistance of the battery (clamp voltage), and controls the current flowing into a load. This prevents the step-up switching regulator from stopping. This clamp voltage can be set to the following equation by using the resistance values $R1$ and $R2$. As shown in the circuit of Figure 6, V_{IN} does not drop below this clamp voltage. Always set $R1 + R2$ below 1 M Ω . V_{clamp} , however, cannot be set below 0.9 V.

$$V_{clamp} = \frac{R1 + R2}{R2} \times V_{INREF}$$

The power of the voltage clamp circuit (Amp1) is supplied from V_{OUT} . According to the signal of $\overline{SD2}$, M2 is turned ON, M3, M4, and M5 are turned OFF, and Amp1 is turned OFF. The current does not flow into the circuit and its clamp operation stops. The standard voltage to Amp1 is obtained by dividing V_{OUT} voltage with resistors $R3$ and $R4$. DO NOT use the $\overline{SD2}$ terminal in floating state because of no internal pulling-up and -down.

When using a motor as a load, connect in parallel a capacitor C_L of 10 μF or more to the load in order to ensure stable operation.

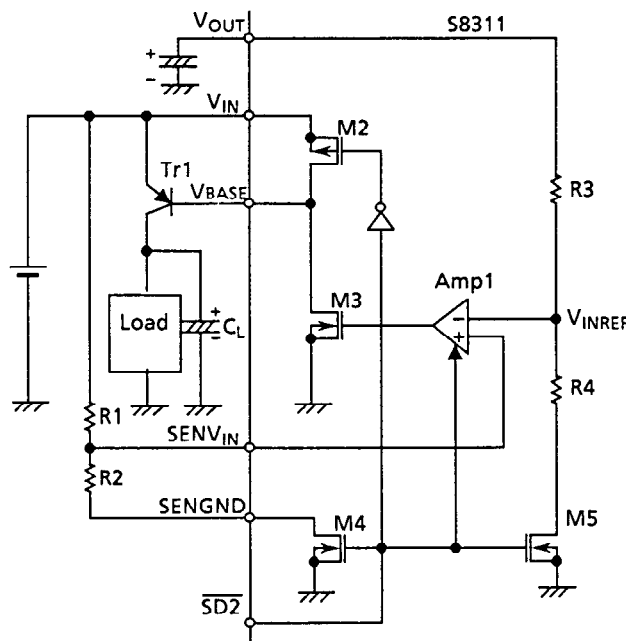

Figure 6

PWM STEP-UP SWITCHING REGULATOR WITH VOLTAGE DETECTORS

S-8310/8311 Series

Select a PNP transistor among transistors having the following characteristics:

- ① $h_{EF} < 100$ or more ($I_C = 100$ mA)
- ② $V_{sat} < 0.15$ V ($I_C = 100$ mA)

The 2SA1362GR or similar transistors are recommendable.

Figure 7 shows the characteristics of the M3 transistors's sink current.

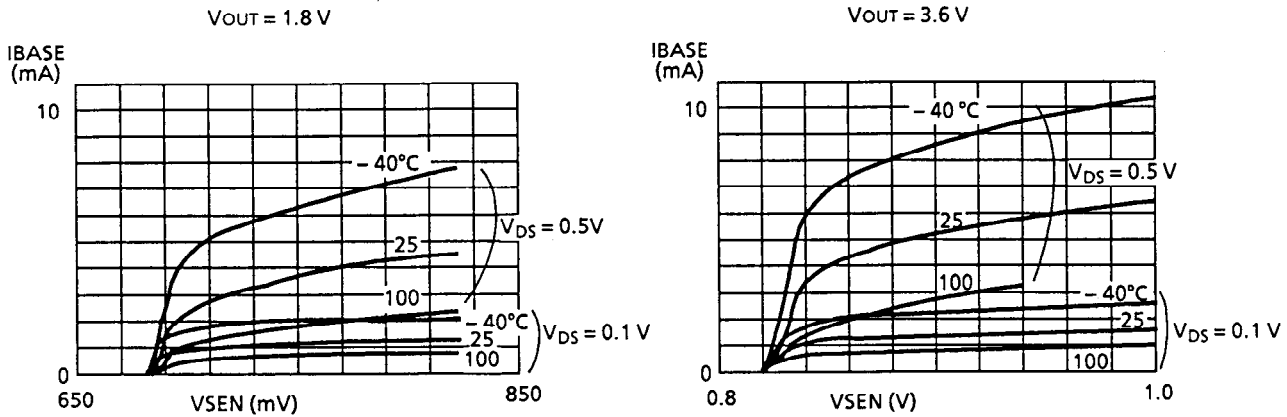

Figure 7

External Part Selection Guidelines

1. Inductor

To minimize a loss due to inductor DC resistance, select an inductor with a resistance of less than 1 Ω DC. Set the inductance value from 47 μ H to 220 μ H.

To stabilize the output voltage (V_{OUT}), it is necessary to supply the energy corresponding to the output current (I_{OUT}) from the inductor. The amount of charge required for I_{OUT} is $I_{OUT} \times (t_{ON} + t_{OFF})$. Because the inductor cannot supply the energy except when M1 is turned OFF (t_{OFF}), the charge is obtained by integrating equation (7) with $0 \rightarrow t_{OFF}$, namely,

$$\frac{I_{PK}}{2} \cdot t_{OFF}. \text{ Thus,}$$

$$\frac{I_{PK}}{2} \cdot t_{OFF} = I_{OUT} \times (t_{ON} + t_{OFF}) \dots\dots\dots (17)$$

$$\therefore I_{PK} = 2 \cdot \frac{t_{ON} + t_{OFF}}{t_{OFF}} \cdot I_{OUT} \dots\dots\dots (18)$$

When the duty ratio of the OSC is 75%, $I_{PK} = 8 \cdot I_{OUT}$. Therefore, an I_{PK} current 8 times as higher than I_{OUT} flows into transistor M1. The S-8310/11 Series, however, includes a switching circuit that controls the current flowing through CONT in order to prevent the IC from being broken due to the excess current. The current limit value is internally set to approximately 320 mA.

When selecting an inductor with a large value of L, both I_{PK} and I_{OUT} decrease. With the energy stored in the inductor is equal to $\frac{1}{2} L \cdot (I_{PK})^2$, even if L becomes large, the energy still decreases because I_{PK} is squared. As a result, step-up at low voltage becomes difficult and the start-up voltage becomes high. However, with DC resistance loss in L and the M1 transistor reduced by only the decrease in I_{PK} , inductance efficiency improves.

On the other hand, when selecting an inductor with a small value of L, both I_{PK} and I_{OUT} increase. The start-up voltage decreases. The inductance efficiency, however, worsens.

【 CAUTION 】 An excess increase in I_{PK} may decrease efficiency drastically due to magnetic saturation depending upon a core material. Use a core material that ensures $I_{sat} > I_{PK}$ (I_{sat} : current causing magnetic saturation).

2. Diode

Use an external diode that can meet the following requirements:

- Low forward voltage ($V_F < 0.3V$)
- High switching speed (500 ns max.)
- Reverse voltage: $V_{OUT} + V_F$ or more
- Rated current: I_{PK} or more

3. Capacitors (C_{IN} , C_{OUT})

Mounting a capacitor at the input side (C_{IN}) can improve the efficiency, reduce the power impedance and stabilize the input current. Select a value of C_{IN} according to the impedance of the power supply you use and set the value of the capacitor to approximately 10 μF .

The capacitor mounted at the output side (C_{OUT}) is used for smoothing the ripple voltage. Select a capacitor with small ESR (Electric Series Resistance) and large capacitance. Set the value of the capacitor to approximately 10 μF . We recommend you use a tantalum electrolytic capacitor or an organic semiconductor capacitor which is superior in temperature and leakage current characteristics.

PWM STEP-UP SWITCHING REGULATOR WITH VOLTAGE DETECTORS

S-8310/8311 Series

Standard Circuit

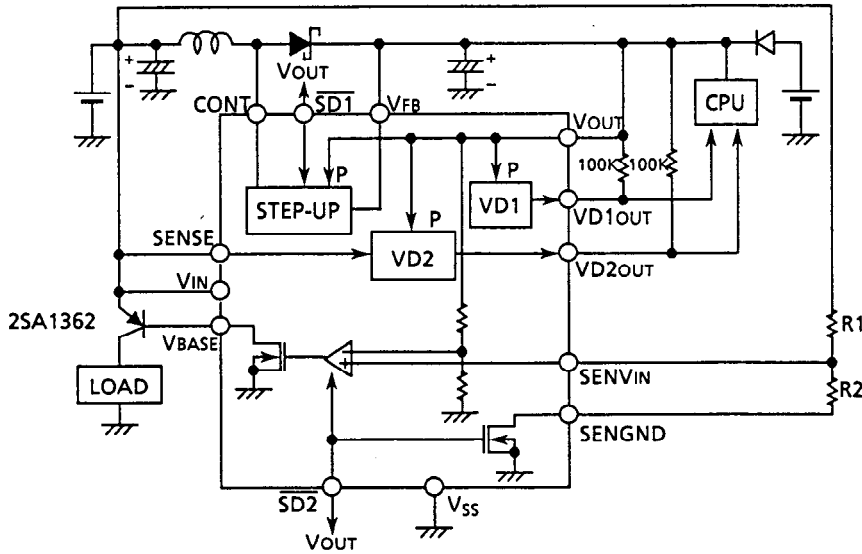

Figure 8

Note: To decrease the ripple voltage at V_{OUT} terminal, insert a π -type filter between V_{FB} and V_{OUT} . When V_{OUT} voltage approximates to detection voltage $VD1$, $VD1$ may be detected due to the ripple voltage. Be careful!!

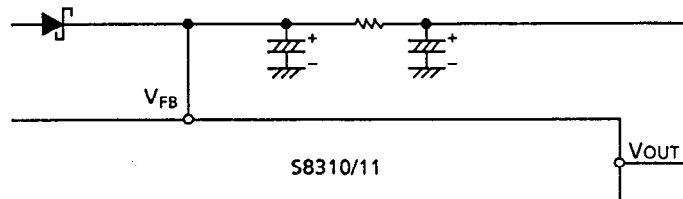

Figure 9

Precautions

- Mount external capacitors, a diode, and a coil nearest to the IC. Always set wiring resistance between the positive terminal of the capacitor (which is connected to V_{OUT} terminal) and V_{OUT} terminal of the IC to less than 0.2Ω . Also, ensure the wiring length of 2 cm or less. If impossible, set a $0.1 \mu F$ ceramic capacitor to V_{OUT} terminal as near as possible.
- Ripple voltage or spike noise may ordinarily occur in switching regulators. Check it using an actually mounted model.
- Seiko Instruments Inc. is not responsible for any problems caused by circuits or other diagrams described herein whose industrial properties, patents or other rights belong to third parties.
- Make sure a loss (especially at high temperatures) in the switching transistor does not exceed the package power dissipation.

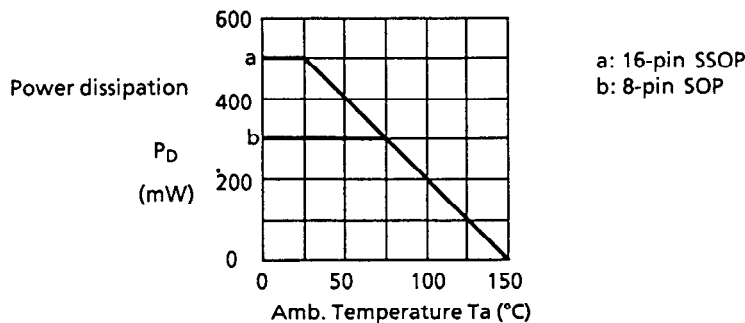

Figure 10 Package power dissipation (before mounting)

PWM STEP-UP SWITCHING REGULATOR WITH VOLTAGE DETECTORS S-8310/8311 Series

Physical Dimensions

8 - Pin SOP (S-8310)

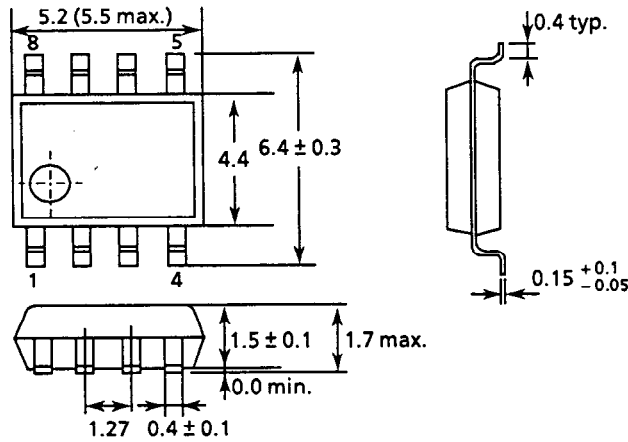

Figure 11

Unit: mm

16 - pin SSOP (S-8311)

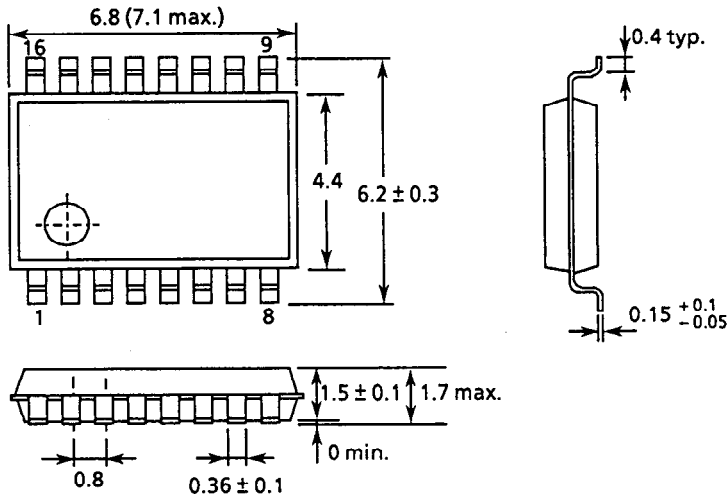
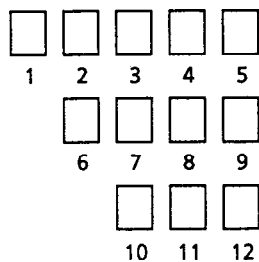

Figure 12

Unit: mm

Markings

1. S8310



- 1 to 6 : Product name
- 7 : Assembly code
- 8 : Year of assembly (last digit)
- 9 : Month of assembly; Jan. = 1, Feb. = 2, Mar. = 3, Apr. = 4, May = 5, Jun. = 6, Jul. = 7, Aug. = 8, Sept. = 9, Oct. = X, Nov. = Y, Dec. = Z
- 10 to 12: Lot No.

Figure 13

2. S8311

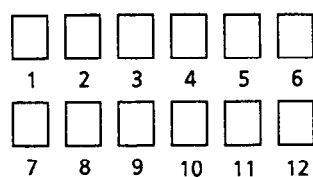

- 1 to 6 : Product name
- 7 : Assembly code
- 8 : Year of assembly (last digit)
- 9 : Month of assembly; Jan. = 1, Feb. = 2, Mar. = 3, Apr. = 4, May = 5, Jun. = 6, Jul. = 7, Aug. = 8, Sept. = 9, Oct. = X, Nov. = Y, Dec. = Z
- 10 to 12: Lot No.

Figure 14

PWM STEP-UP SWITCHING REGULATOR WITH VOLTAGE DETECTORS
S-8310/8311 Series

■ Taping

1. Tape specifications (S8310)

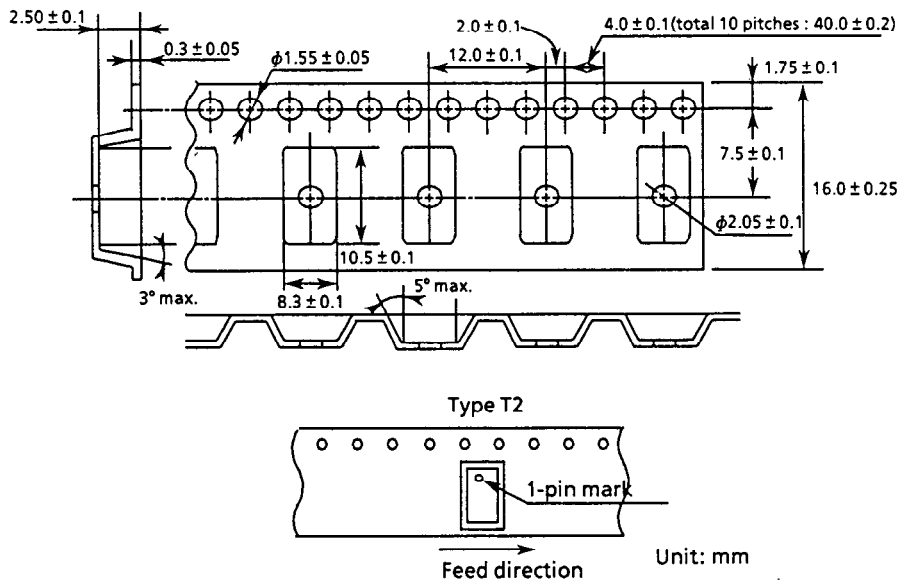

Figure 15

2. Reel specifications

1 reel holds 2000 ICs.

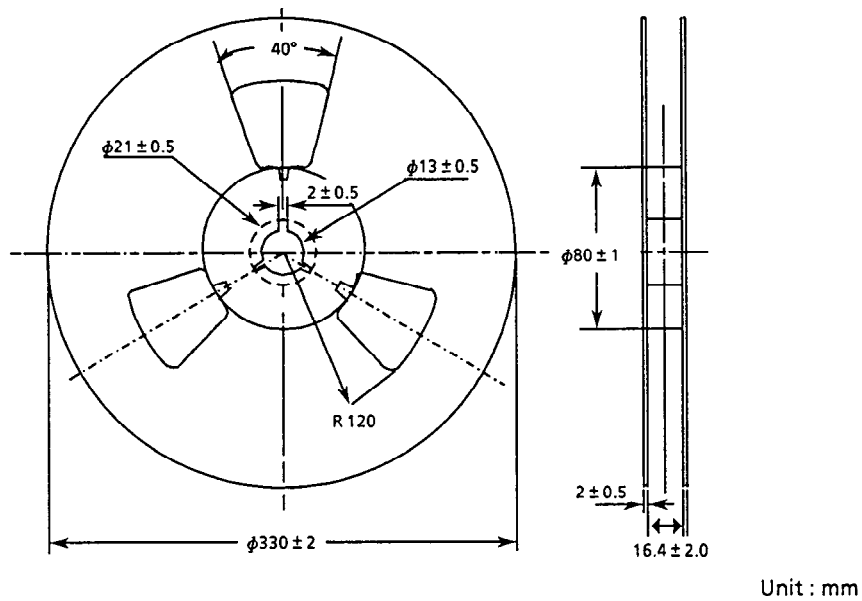

Figure 16

PWM STEP-UP SWITCHING REGULATOR WITH VOLTAGE DETECTORS
S-8310/8311 Series

■ Taping

1. Tape specifications (S8311)

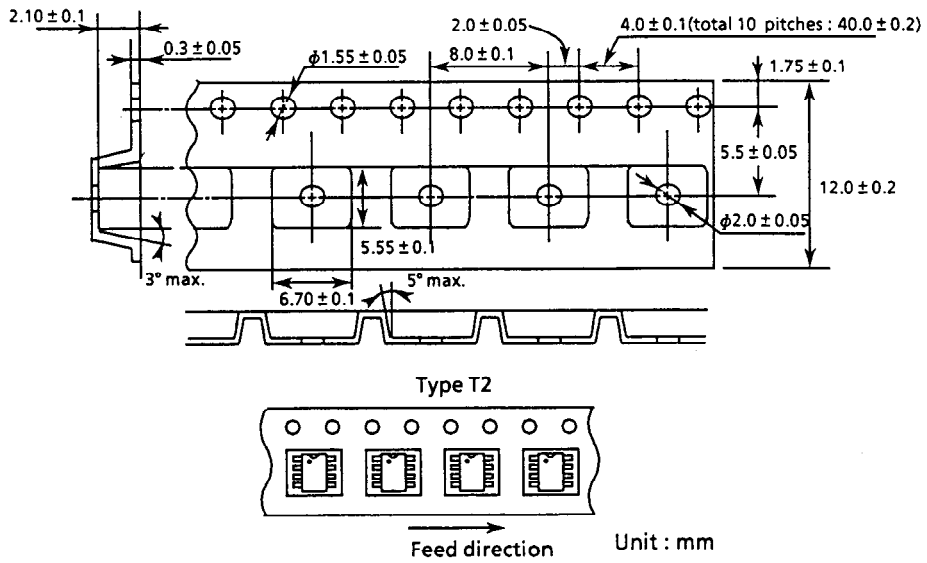

Figure 17

2. Reel specifications

1 reel holds 2000 ICs.

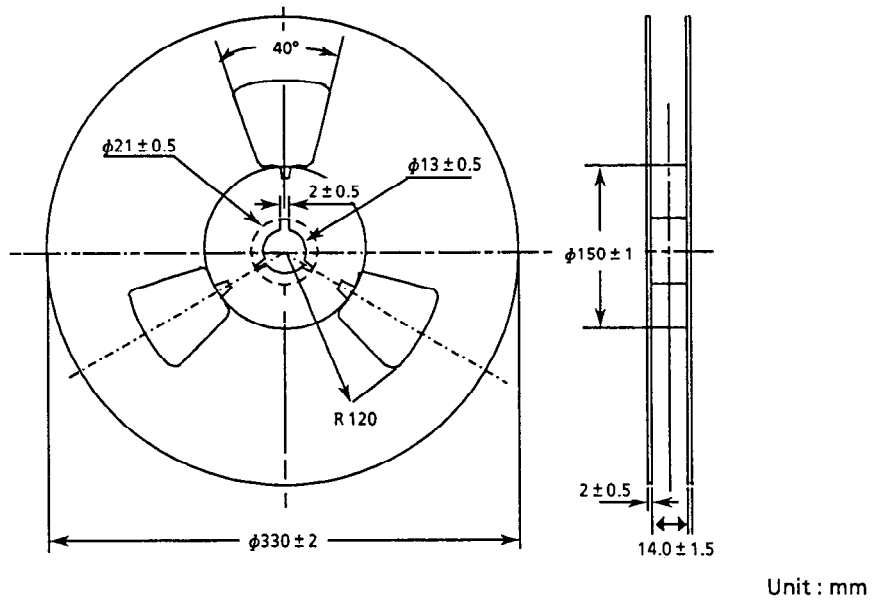

Figure 18

PWM STEP-UP SWITCHING REGULATOR WITH VOLTAGE DETECTORS

S-8310/8311 Series

■ Characteristics (typical data)

1. Current consumption – Power voltage

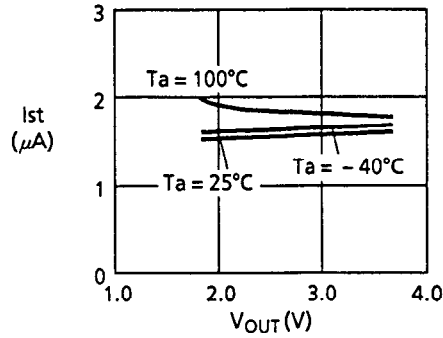
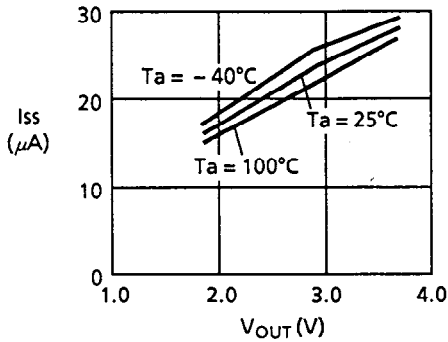

2. Oscillation frequency, maximum duty ratio – Temperature

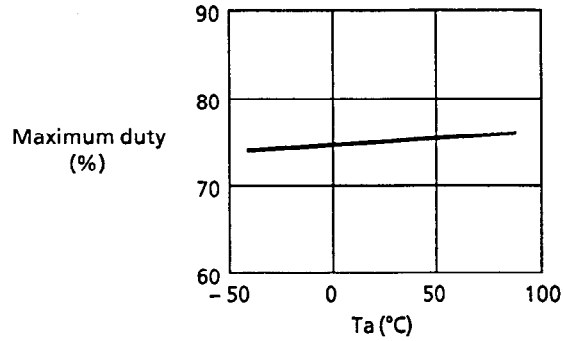
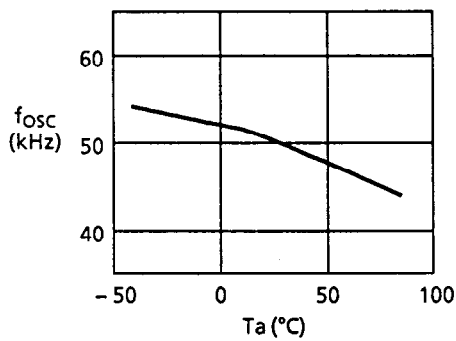

3. Shutdown terminal input voltage – Output voltage

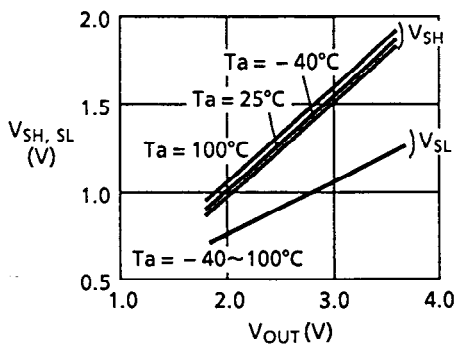

4. CONT switching current – Output voltage

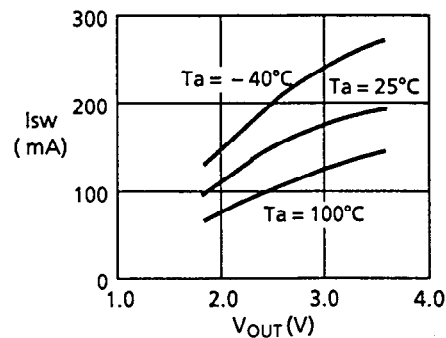

5. Operation start, retention voltage – Temperature

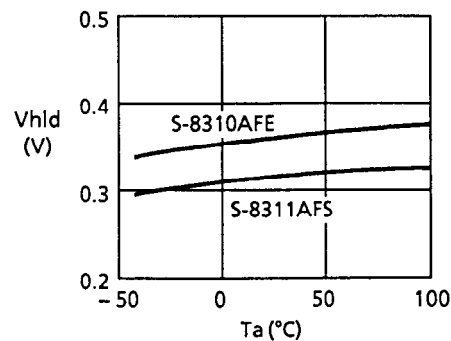
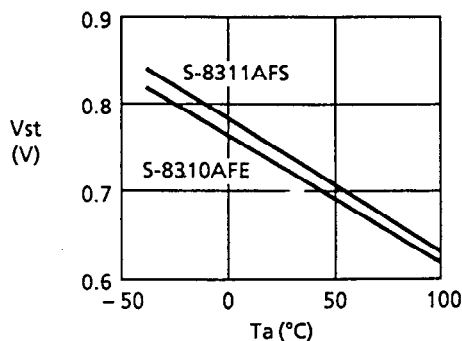

Use only parts which meet specified electrical characteristics.

PWM STEP-UP SWITCHING REGULATOR WITH VOLTAGE DETECTORS S-8310/8311 Series

6. Ripple voltage – Output current

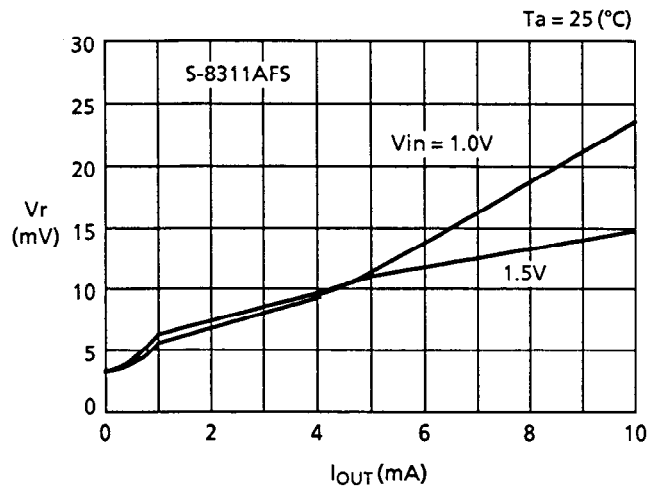
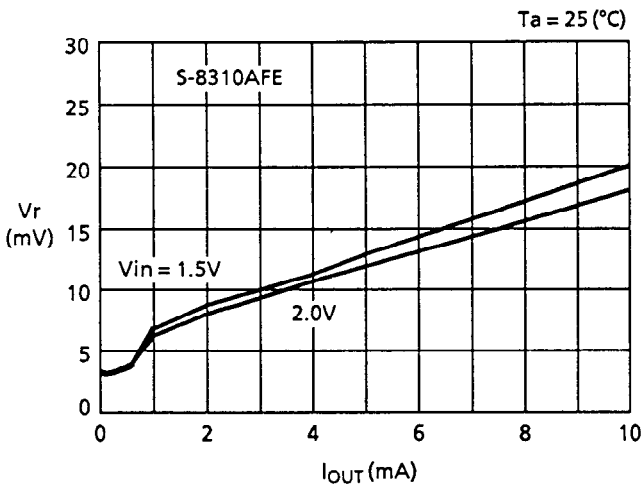

Use only parts which meet specified electrical characteristics.

Reference Data

1. Transit response characteristics

Use only parts which meet specified electrical characteristics.

1.1 Powering on (Ta = 25°C)

- V_{IN} = 0 V → 1.5 V, I_{OUT} = 5 mA

Sample S-8310AFE

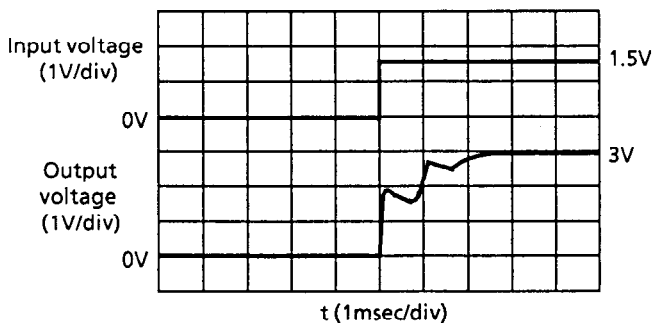

Sample S-8311AFS

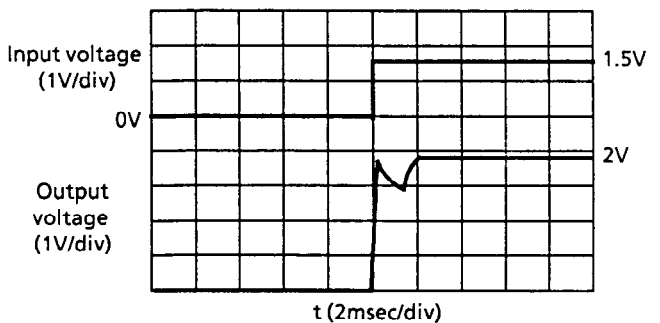

1.2 Shut down response (Ta = 25°C)

- SD1 = 0 V → V_{OUT}, V_{IN} = 1.5 V, I_{OUT} = 5 mA

Sample S-8310AFE

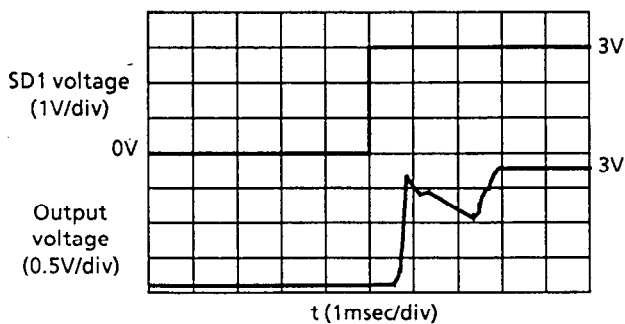

Sample S-8311AFS

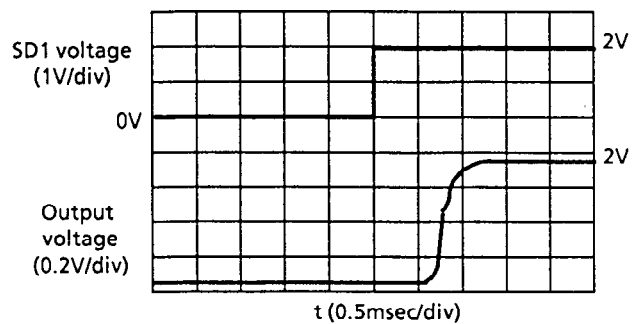

PWM STEP-UP SWITCHING REGULATOR WITH VOLTAGE DETECTORS

S-8310/8311 Series

1.3 Power voltage variation ($T_a = 25^\circ\text{C}$)

- $V_{IN} = 1.3\text{V} \leftrightarrow V_{OUT}, I_{out} = 5\text{ mA}$

Sample S-8310AFE

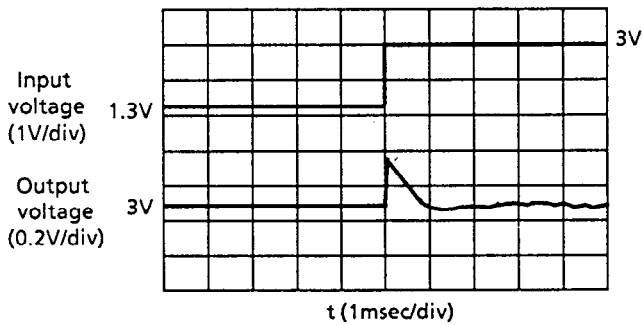

Sample S-8310AFE

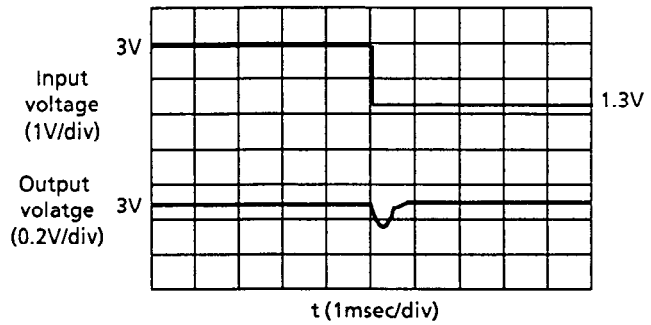

Sample S-8311AF5

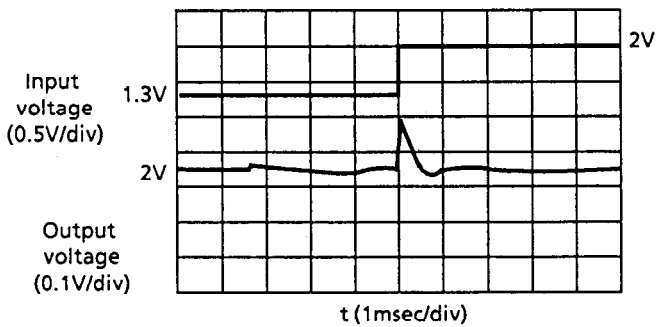

Sample S-8311AF5

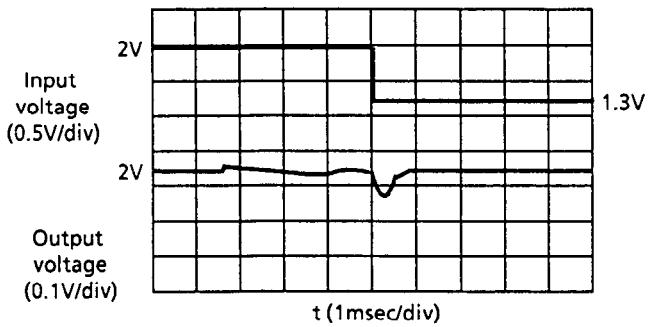

1.4 Load current variation ($T_a = 25^\circ\text{C}$)

- $I_{out} = 10\mu\text{A} \leftrightarrow 5\text{ mA}, V_{IN} = 1.5\text{V}$

Sample S-8310AFE

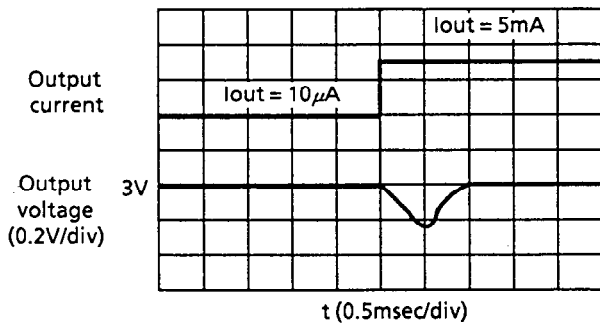

Sample S-8310AFE

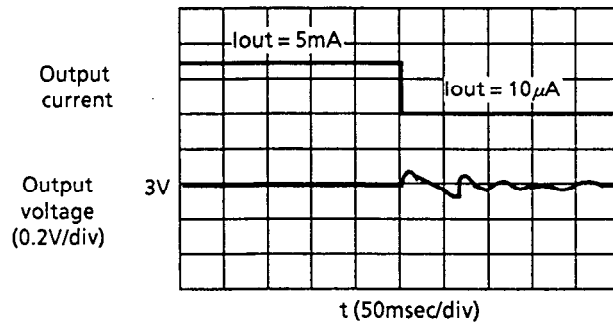

Sample S-8311AF5

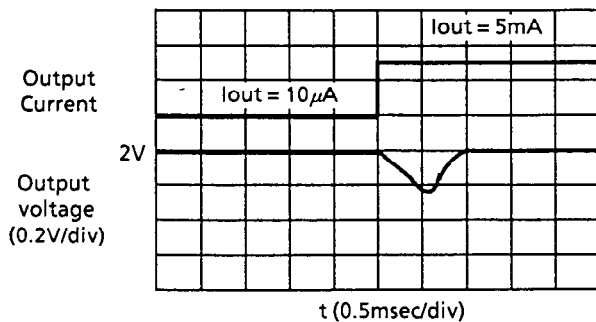

Sample S-8311AF5

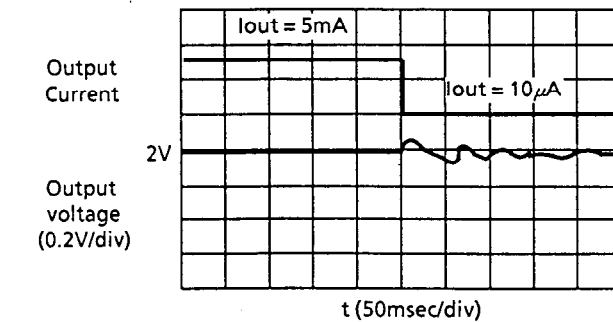

PWM STEP-UP SWITCHING REGULATOR WITH VOLTAGE DETECTORS

S-8310/8311 Series

Reference Data

The following are step-up characteristics when using the coils shown in the following list:

Evaluated coils

Model	Manufacturer	Value L (μ H)	Max. DC resistance (Ω)	Permissible current (mA)
CD54	Sumida Electric	47	0.37	720
↑	↑	100	0.7	520
↑	↑	220	1.57	350
LQH3C	Murata Mnaufacturing	47	1.7	170
↑	↑	100	4.6	100
CP4LBM	Sumida Electric	47	2.2	220
↑	↑	220	10.5	100

For parts other than coils, use parts which meet specified electrical characteristics.

[I] S-8310AFE

1.1 CD54 (47 μ H), Ta = 25°C

(a) Input voltage – Output voltage characteristics

(rise in input voltage)

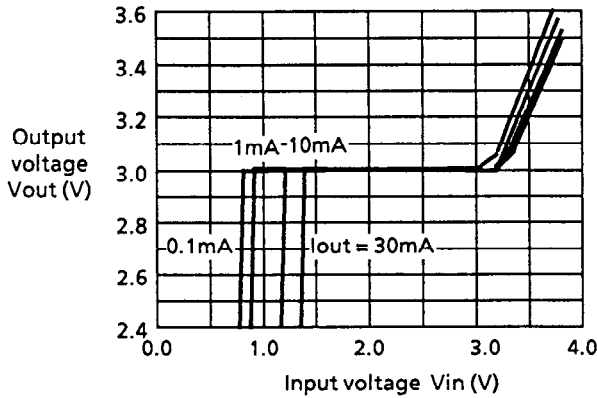

(b) Input voltage – Output voltage characteristics

(fall in input voltage)

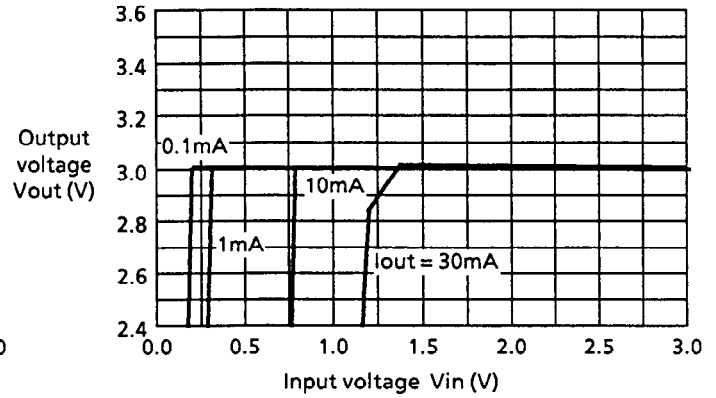

(c) Output current – Output voltage characteristics

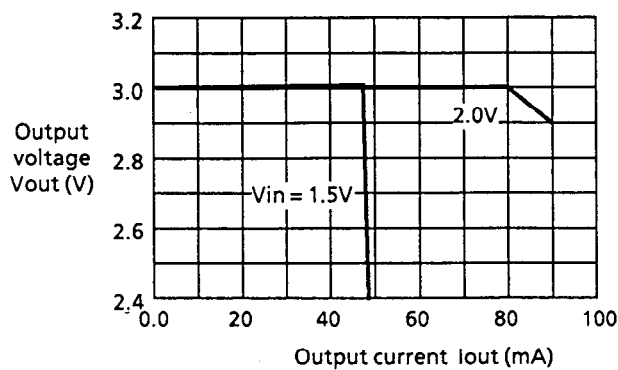

(d) Efficiency – Input voltage characteristics

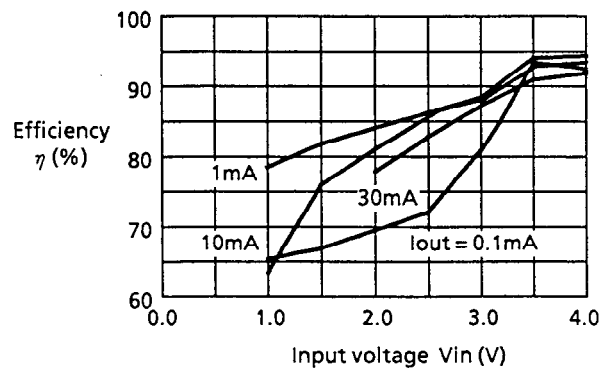

PWM STEP-UP SWITCHING REGULATOR WITH VOLTAGE DETECTORS

S-8310/8311 Series

1.2 CD54 (100 μ H), Ta = 25°C

(a) Input voltage – Output voltage characteristics

(rise in input voltage)

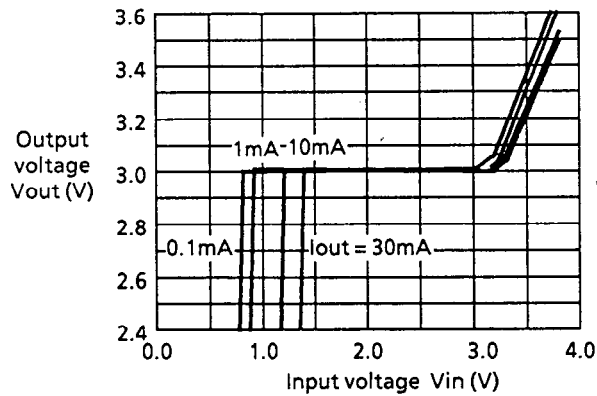

(b) Input voltage – Output voltage characteristics

(fall in input voltage)

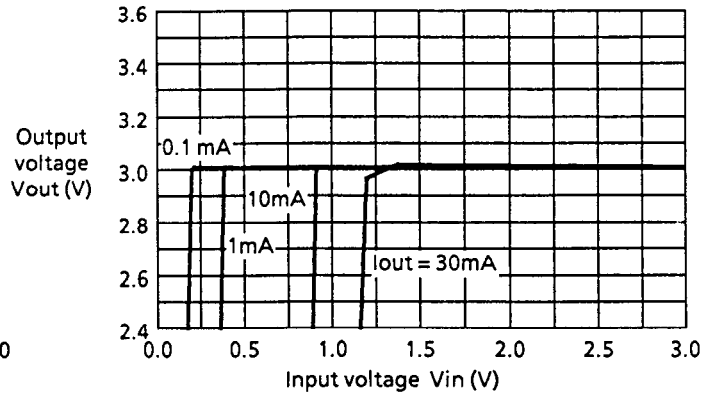

(c) Output current – Output voltage characteristics

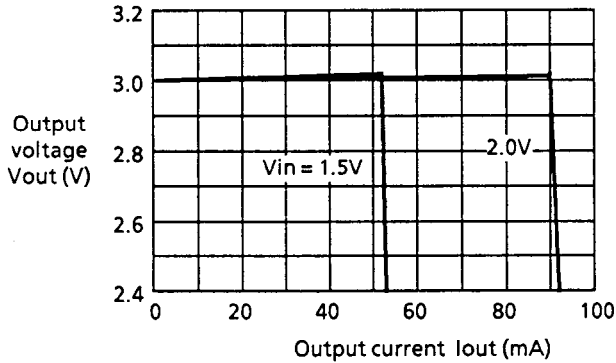

(d) Efficiency – Input voltage characteristics

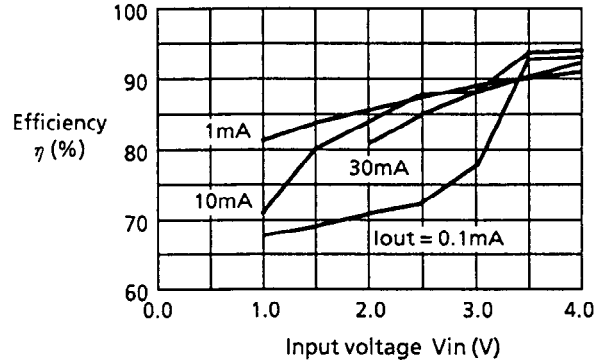

1.3 CD54 (220 μ H), Ta = 25°C

(a) Input voltage – Output voltage characteristics

(rise in input voltage)

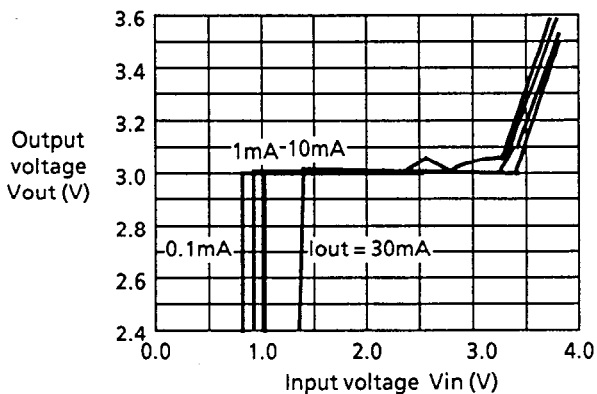

(b) Input voltage – Output voltage characteristics

(fall in input voltage)

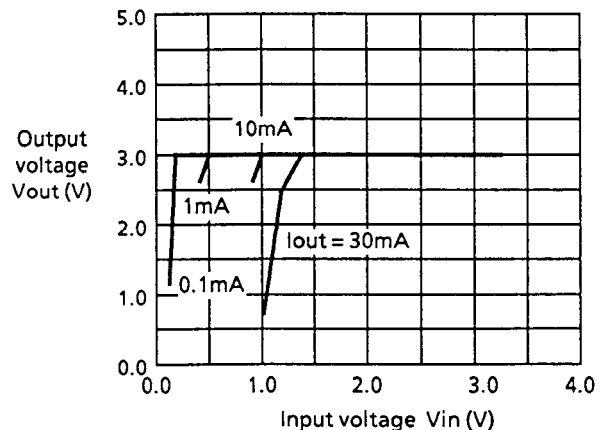

PWM STEP-UP SWITCHING REGULATOR WITH VOLTAGE DETECTORS
S-8310/8311 Series

(c) Output current – Output voltage characteristics

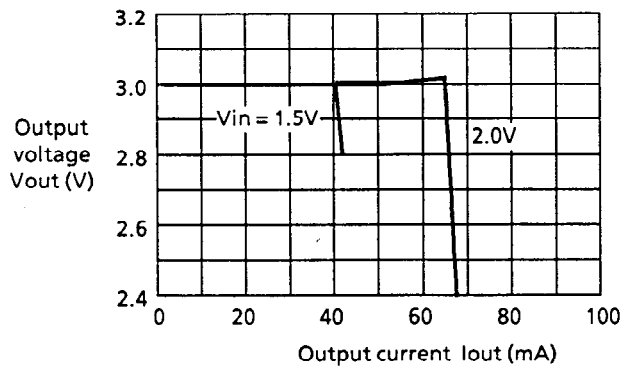

(d) Efficiency – Input voltage characteristics

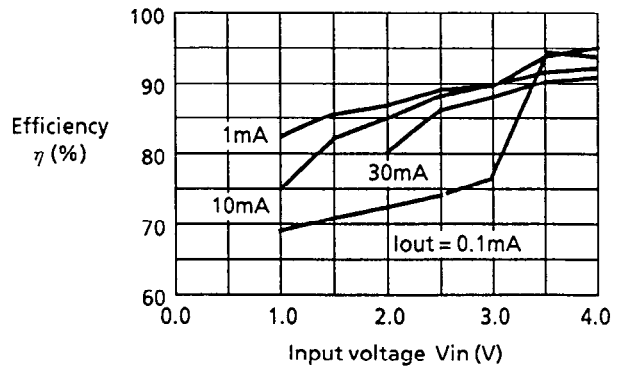

2.1 LQH3C (47 μ H), Ta = 25°C

(a) Input voltage – Output voltage characteristics

(rise in input voltage)

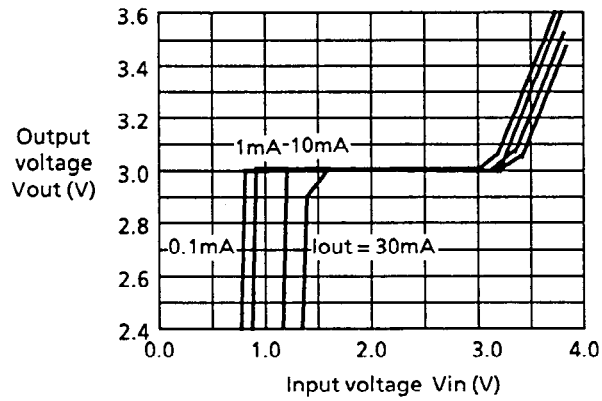

(b) Input voltage – Output voltage characteristics

(fall in input voltage)

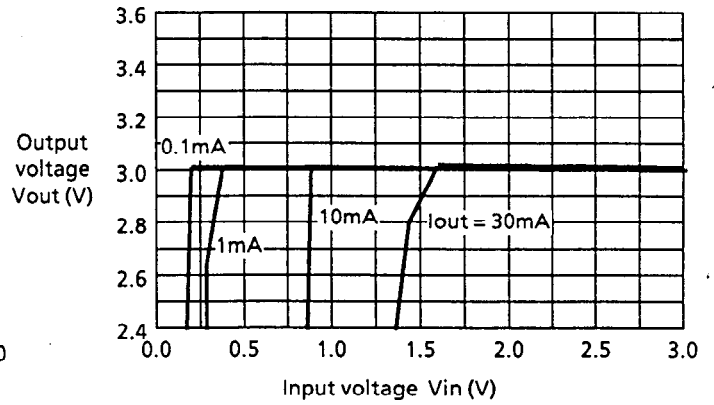

PWM STEP-UP SWITCHING REGULATOR WITH VOLTAGE DETECTORS
S-8310/8311 Series

(c) Output current – Output voltage characteristics

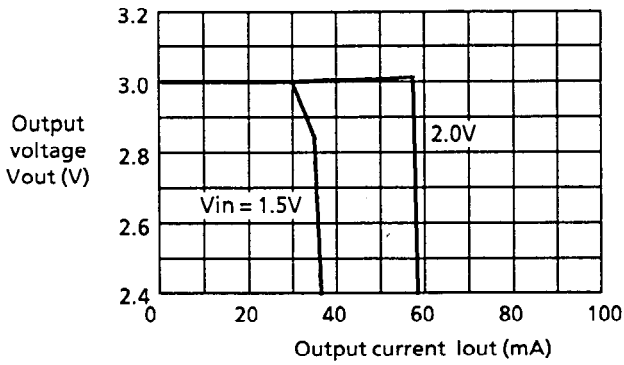

(d) Efficiency – Input voltage characteristics

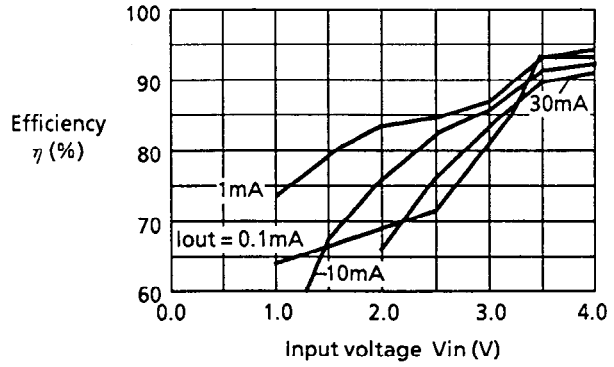

2.2 LQH3C (100 μ H), $T_a = 25^\circ C$

(a) Input voltage – Output voltage characteristics

(rise in input voltage)

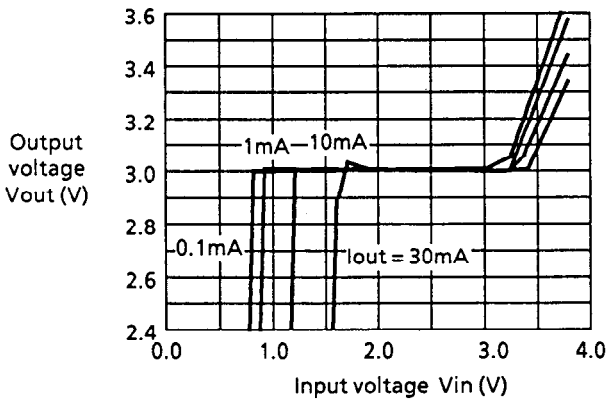

(b) Input voltage – Output voltage characteristics

(fall in input voltage)

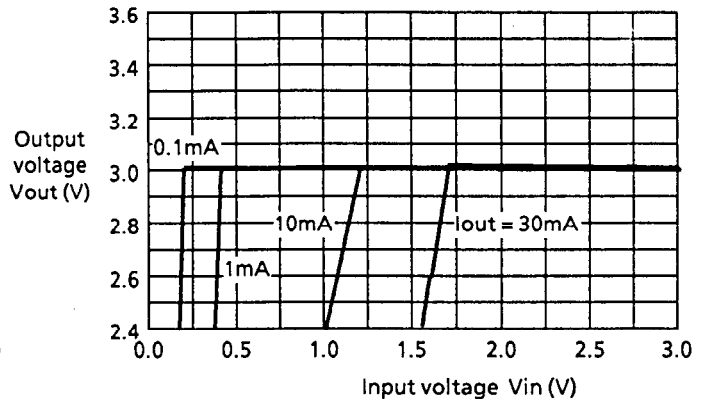

(c) Output current – Output voltage characteristics

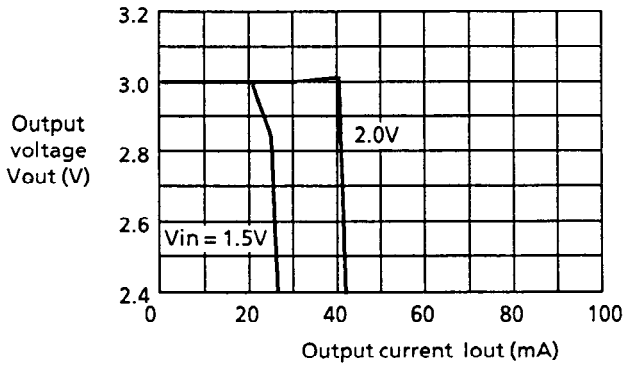

(d) Efficiency – Input voltage characteristics

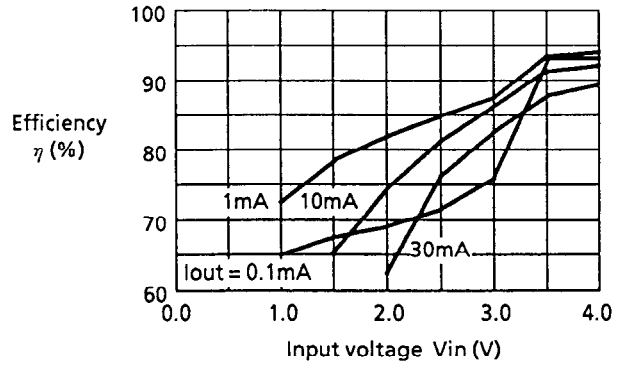

PWM STEP-UP SWITCHING REGULATOR WITH VOLTAGE DETECTORS S-8310/8311 Series

3.1 CP4LBM (47 μ H), Ta = 25°C

(a) Input voltage – Output voltage characteristics

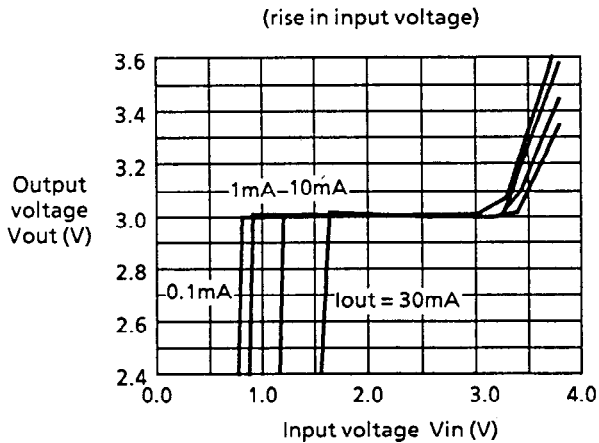

(b) Input voltage – Output voltage characteristics

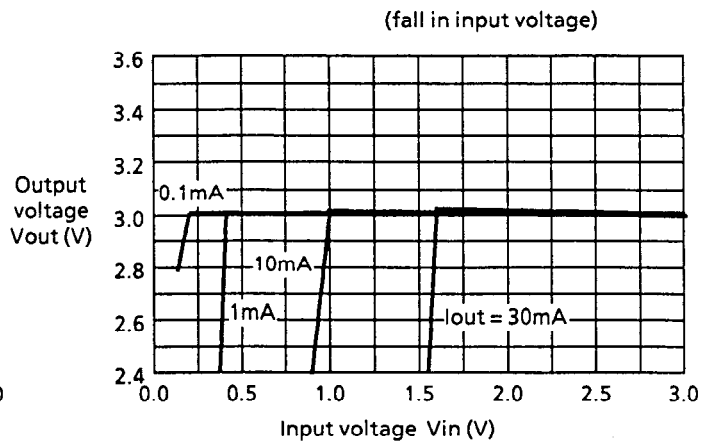

(c) Output current – Output voltage characteristics

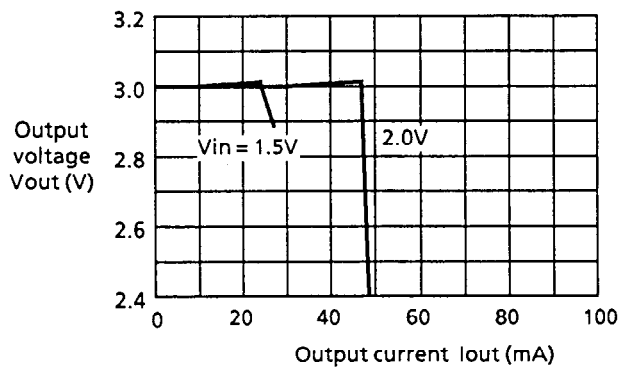

(d) Efficiency – Input voltage characteristics

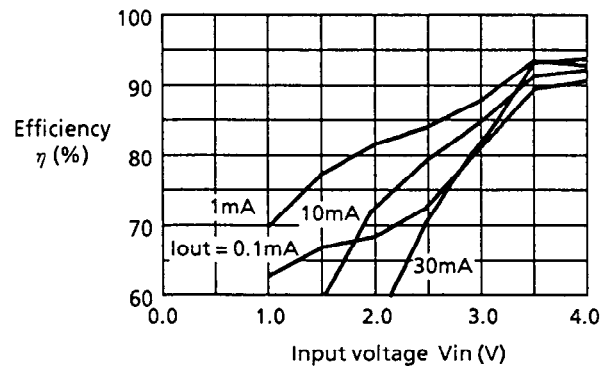

3.2 CP4LBM (220 μ H), Ta = 25°C

(a) Input voltage – Output voltage characteristics

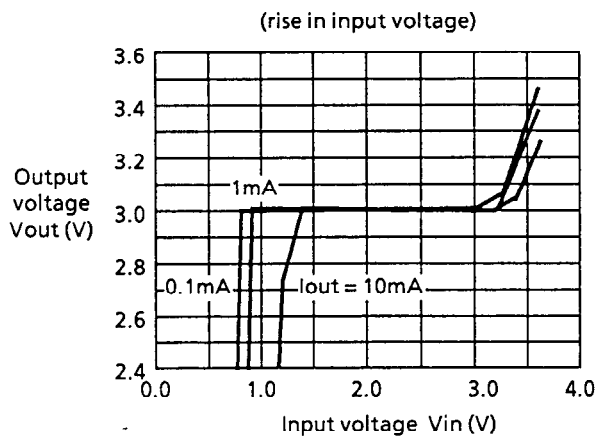

(b) Input voltage – Output voltage characteristics

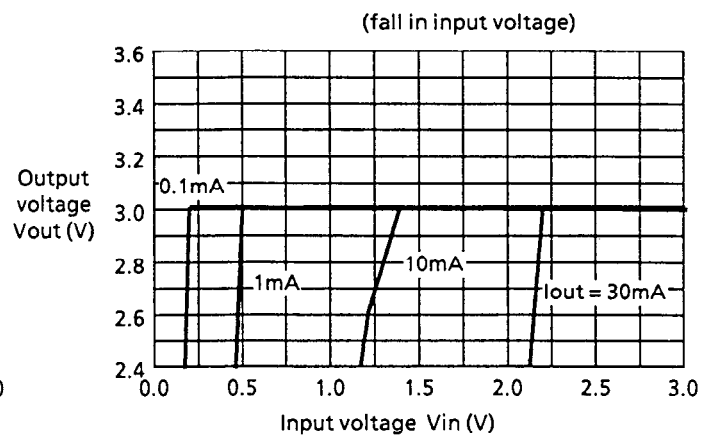

PWM STEP-UP SWITCHING REGULATOR WITH VOLTAGE DETECTORS
S-8310/8311 Series

(c) Output current – Output voltage characteristics

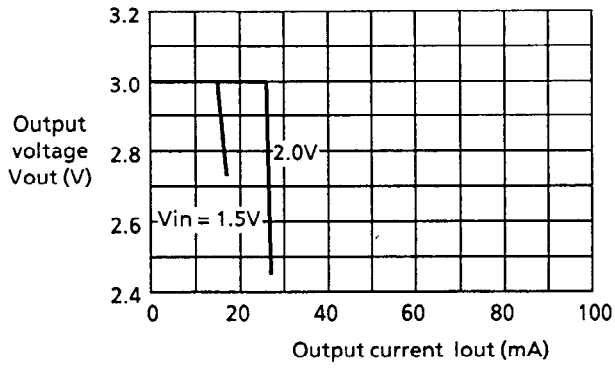

(d) Efficiency – Input voltage characteristics

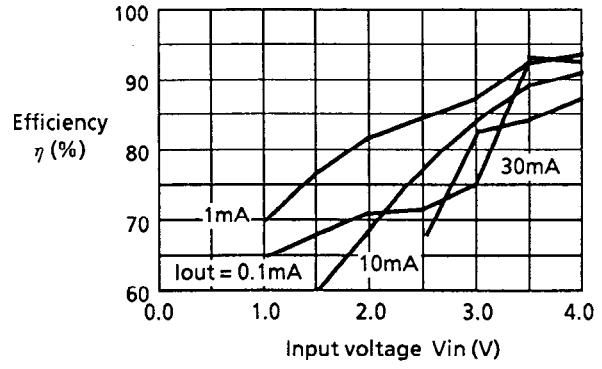

[II] S-8311AFS

1.1 CD54 (47 μ H), Ta = 25°C

(a) Input voltage – Output voltage characteristics

(rise in input voltage)

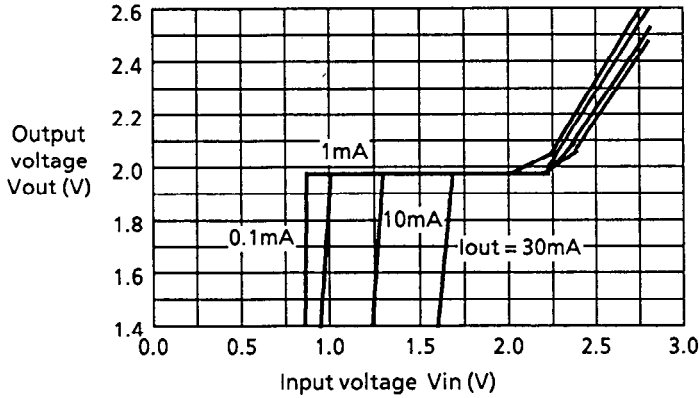

(b) Input voltage – Output voltage characteristics

(fall in input voltage)

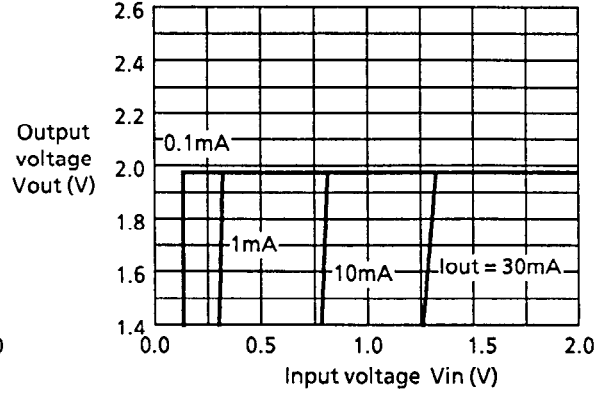

(c) Output current – Output voltage characteristics

(rise in input voltage)

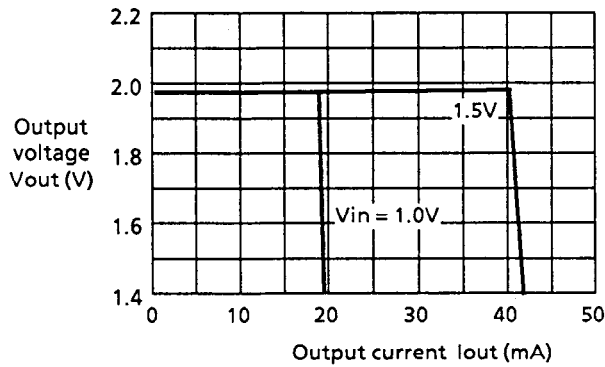

(d) Efficiency – Input voltage characteristics

(fall in input voltage)

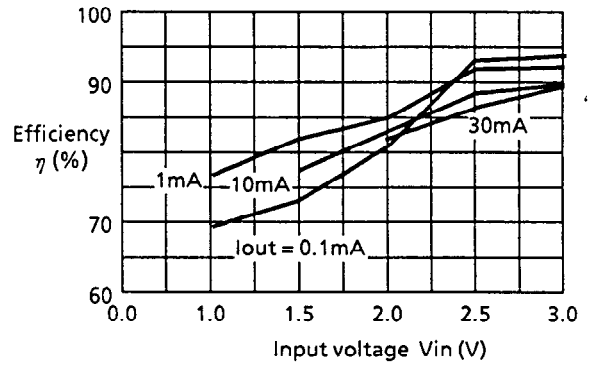

1.2 CD54 (100 μ H), Ta = 25°C

(a) Input voltage – Output voltage characteristics

(rise in input voltage)

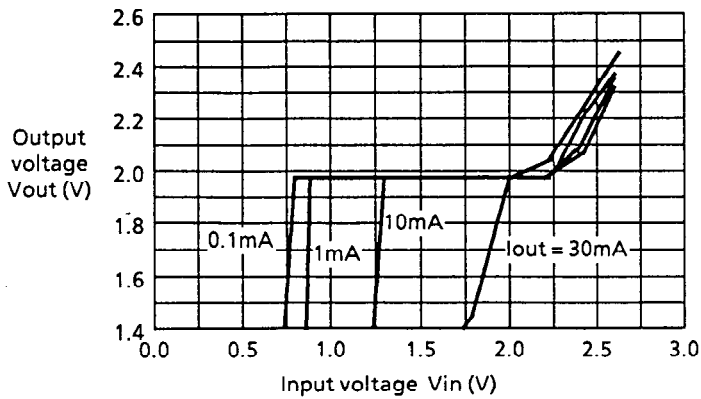

(b) Input voltage – Output voltage characteristics

(fall in input voltage)

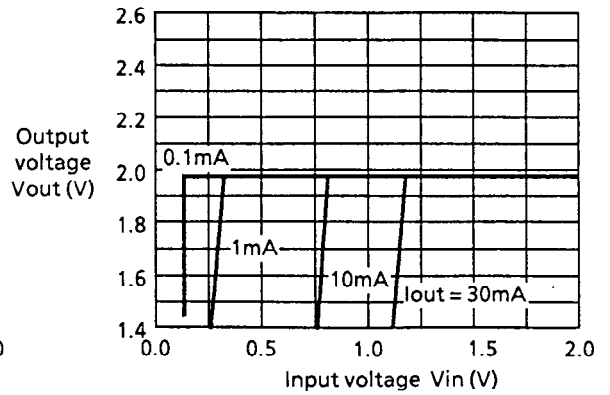

PWM STEP-UP SWITCHING REGULATOR WITH VOLTAGE DETECTORS
S-8310/8311 Series

(c) Output current – Output voltage characteristics

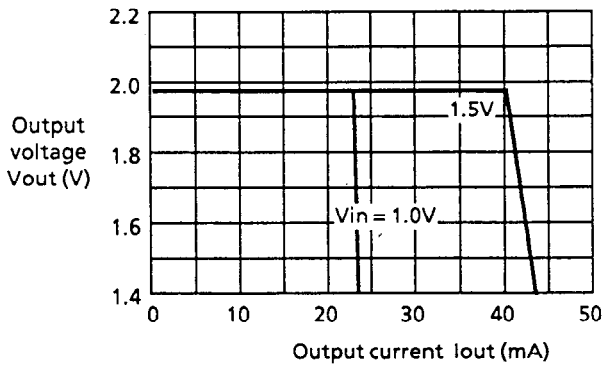

(d) Efficiency – Input voltage characteristics

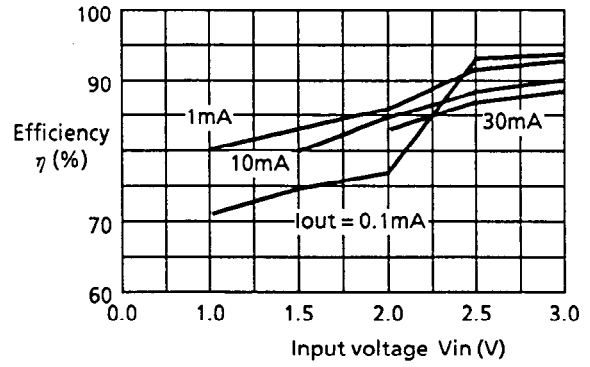

1.3 CD54 (220 μ H), $T_a = 25^\circ\text{C}$

(a) Input voltage – Output voltage characteristics

(rise in input voltage)

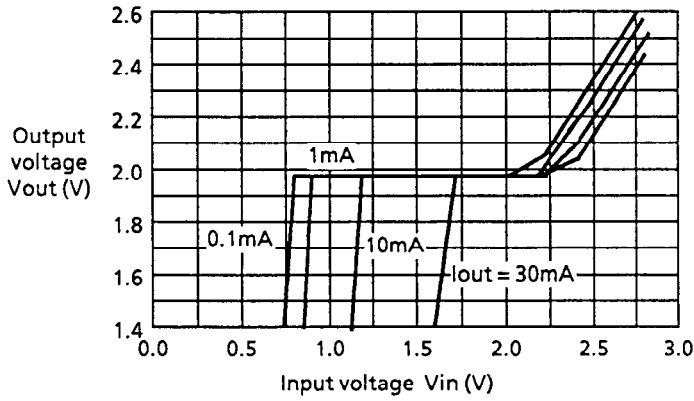

(b) Input voltage – Output voltage characteristics

(fall in input voltage)

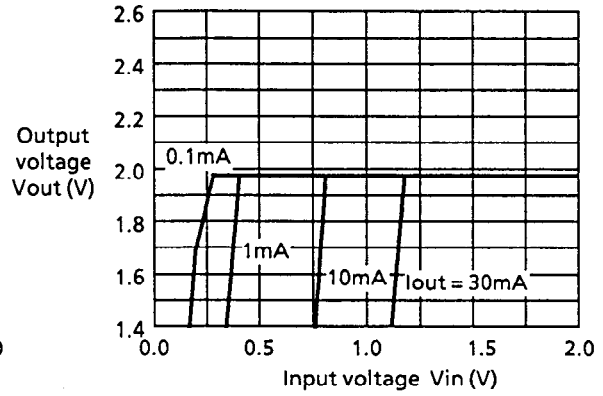

(c) Output current – Output voltage characteristics

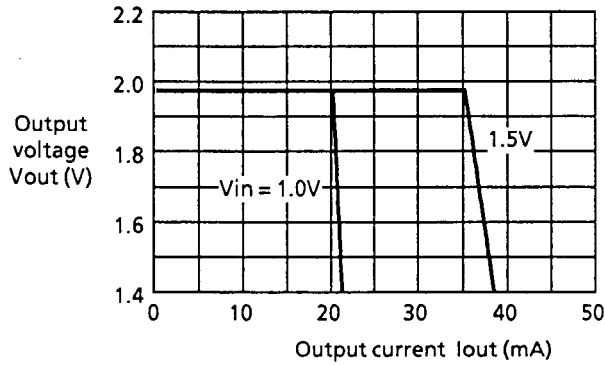

(d) Efficiency – Input voltage characteristics

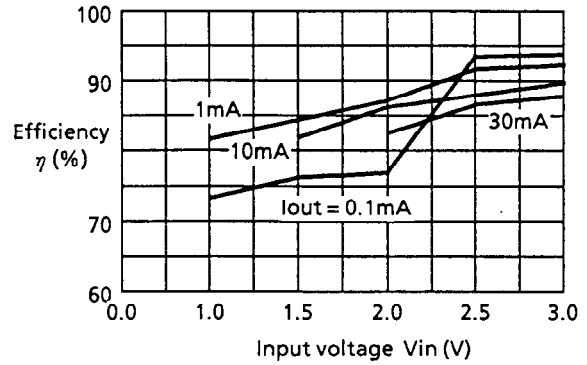

PWM STEP-UP SWITCHING REGULATOR WITH VOLTAGE DETECTORS

S-8310/8311 Series

2.1 LQH3C (47 μ H), Ta = 25°C

(a) Input voltage – Output voltage characteristics
(rise in input voltage)

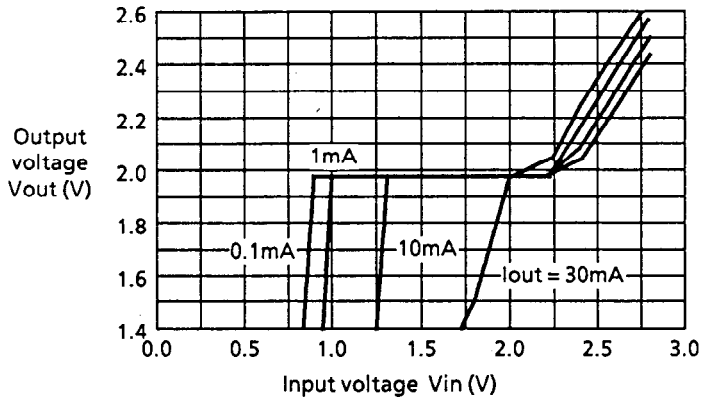

(b) Input voltage – Output voltage characteristics
(fall in input voltage)

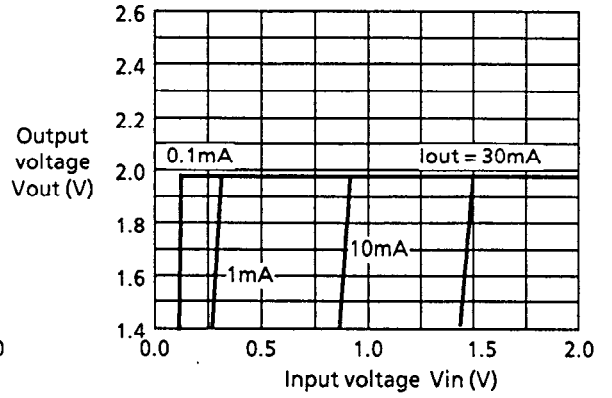

(c) Output current – Output voltage characteristics

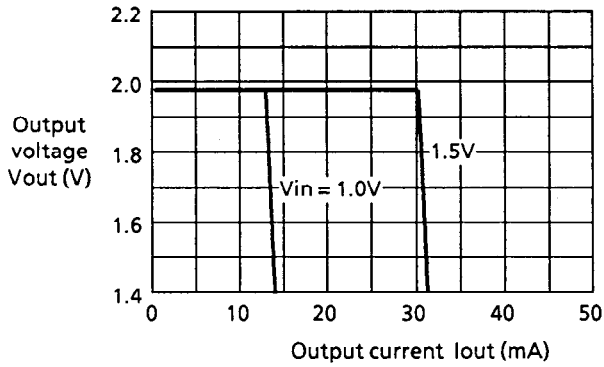

(d) Efficiency – Input voltage characteristics

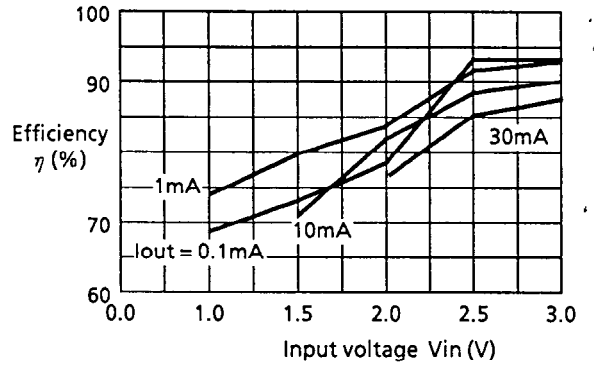

2.2 LQH3C (100 μ H), Ta = 25°C

(a) Input voltage – Output voltage characteristics
(rise in input voltage)

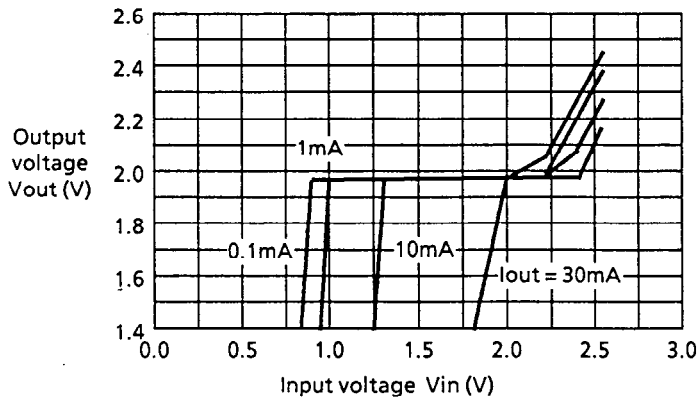

(b) Input voltage – Output voltage characteristics
(fall in input voltage)

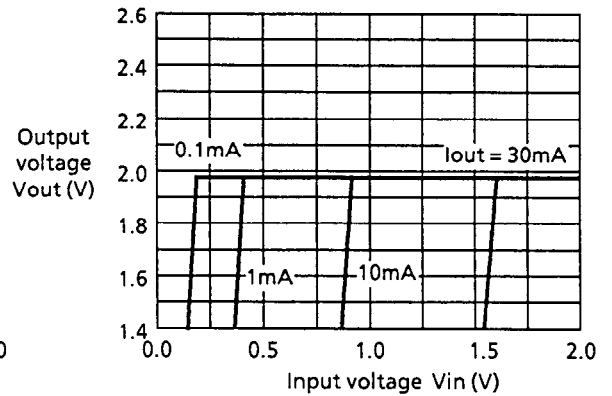

PWM STEP-UP SWITCHING REGULATOR WITH VOLTAGE DETECTORS
S-8310/8311 Series

(c) Output current – Output voltage characteristics

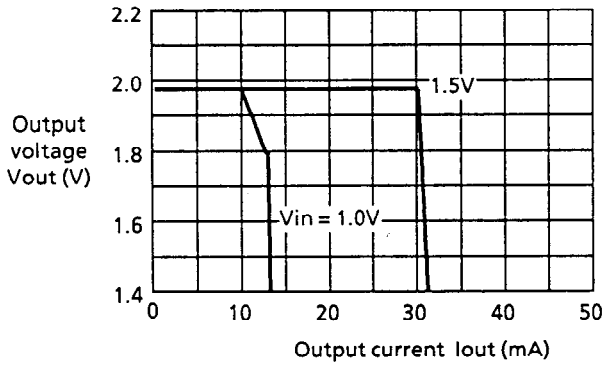

(d) Efficiency – Input voltage characteristics

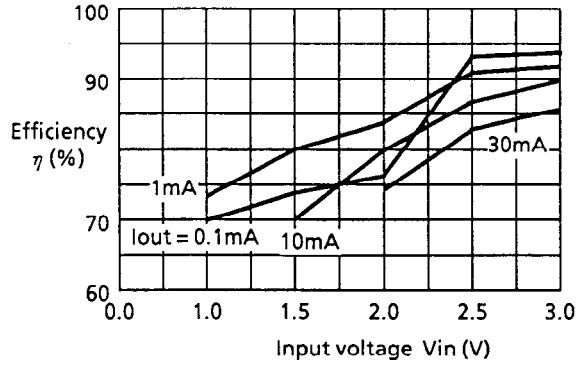

3.1 CP4LBM (47 μ H), $T_a = 25^\circ C$

(a) Input voltage – Output voltage characteristics

(rise in input voltage)

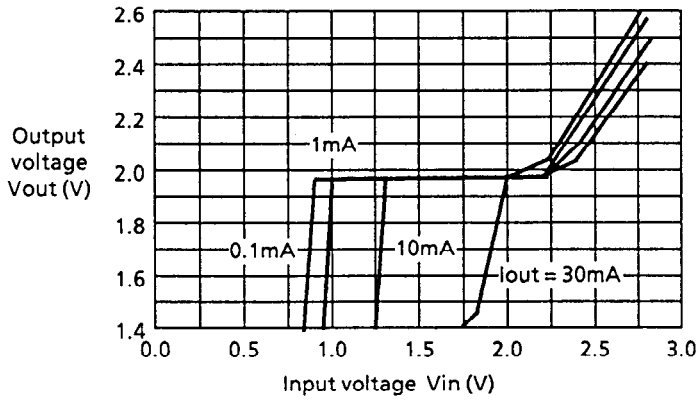

(b) Input voltage – Output voltage characteristics

(fall in input voltage)

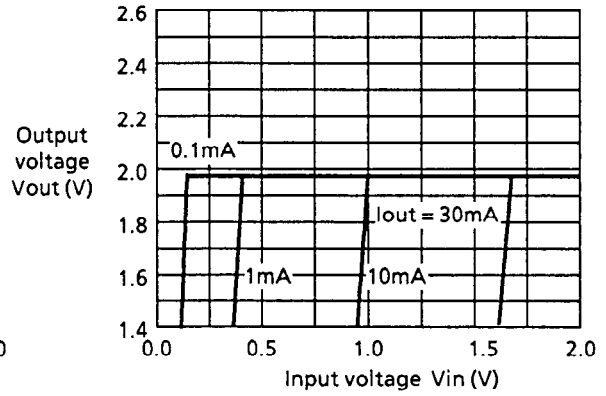

(c) Output current – Output voltage characteristics

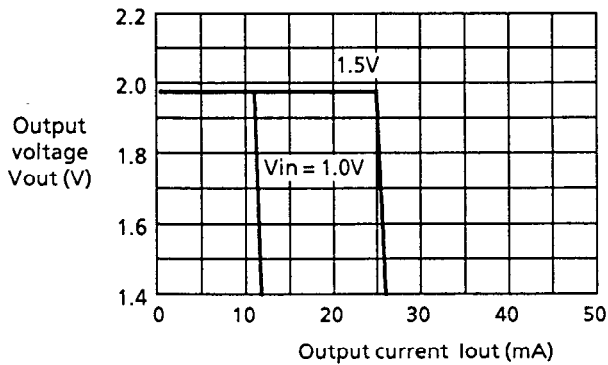

(d) Efficiency – Input voltage characteristics

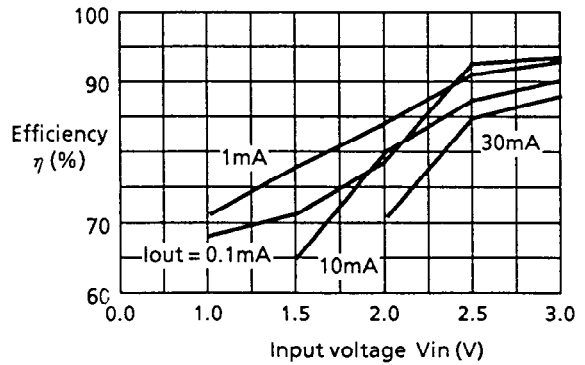

PWM STEP-UP SWITCHING REGULATOR WITH VOLTAGE DETECTORS
S-8310/8311 Series

- 3.2 CP4LBM (220 μ H), Ta = 25°C

(a) Input voltage – Output voltage characteristics

(rise in input voltage)

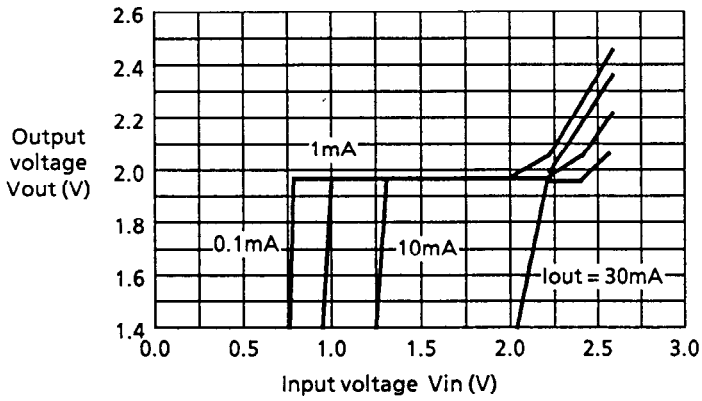

(b) Input voltage – Output voltage characteristics

(fall in input voltage)

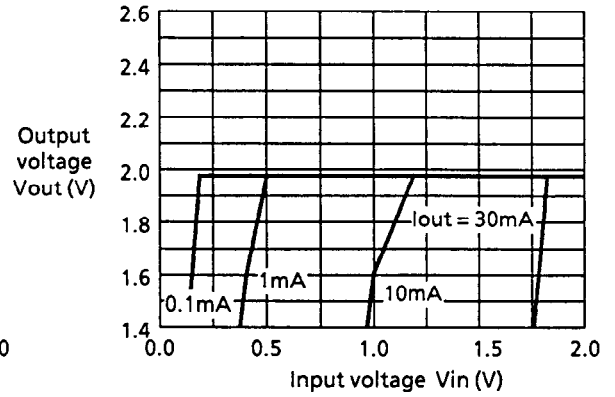

(c) Output current – Output voltage characteristics

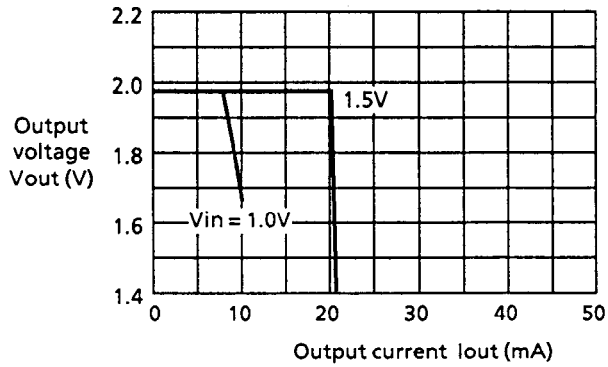

(d) Efficiency – Input voltage characteristics

