Synchronous PWM control Step-Down Switching Regulator-Controllers

S-8532 Series

The S-8532 series is a family of CMOS synchronous PWM control step-down switching regulator-controllers consisting of a reference voltage source, oscillation circuit, an error amplifier, phase compensation circuit, PWM control circuit.

A high efficiency and large current step-down switching regulator is realized by only adding a P-channel and an N-channel power MOSFETs, a coil, and 3 capacitors. Small external components can be used due to the high frequency oscillation at 300kHz. The efficiency of the switching regulator should be 3 to 10% higher than that of the conventional step-down switching regulator.

Small and thin 8-pin TSSOP and 8-pin SON package together with the high oscillation frequency make the S-8532 series serve as an ideal power source for portable devices.

■ Features

- High efficiency (typ. 94%)
- Using an external P channel and an N channel MOS transistors a battery can be fully utilized with the help of maximum duty ratio of 100%.
- Current limiting circuit Current is set by an external resistor RSENSE.
- Oscillation frequency: 300 kHz
- Input voltage: 2.7 to 16.0V
- Output voltage: 1.5 to 6.0V, 0.1V step
- Output voltage accuracy: ±2.0%
- Soft start Time is set by an external capacity CSS.
- Power-off function
- Small packages 8-pin TSSOP, 8-pin SON(B)

■ Package

- 8-pin TSSOP (Package drawing code: FT008-A)
- 8-pin SON(B) (Package drawing code: PA008-B)

■ Applications

- Power supplies for portable devices, such as PDAs, electronic organizers, and cellular phones
- Main or sub power source for notebook computers and peripherals

■ **Block Diagram**

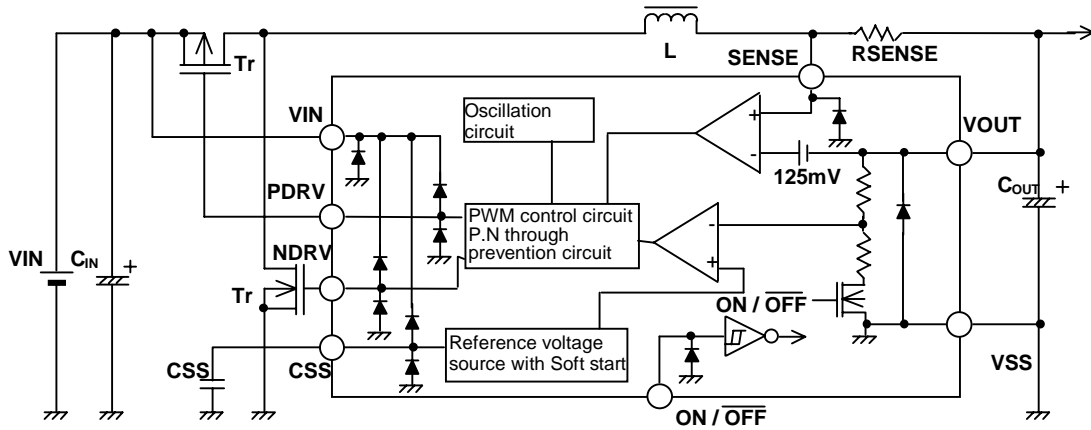

Note: The diode inside the IC is a parasitic diode.

Figure 1 Block diagram

■ **Selection Guide**

1. Product Name

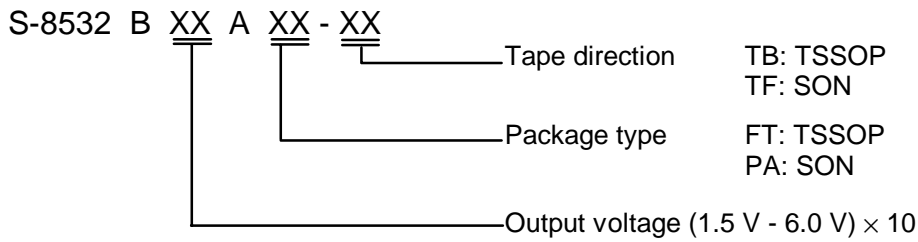

2. Product List (as of November 1, 2000)

Output voltage	Product name	
	Package : 8-pin TSSOP	Package : 8-pin SON-B
1.5V	S-8532B15AFT-TB	S-8532B15APA-TF
2.5V	S-8532B25AFT-TB	S-8532B25APA-TF
3.0V	S-8532B30AFT-TB	S-8532B30APA-TF
3.3V	S-8532B33AFT-TB	S-8532B33APA-TF
5.0V	S-8532B50AFT-TB	S-8532B50APA-TF

Pin Assignment

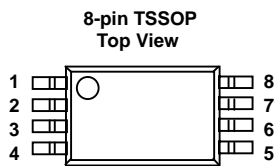

Figure 2

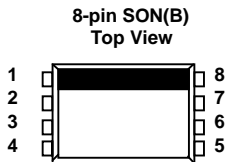

Figure 3

Pin No.	Pin Name	Function
1	SENSE	Current limiting detection pin
2	VOUT	Output voltage pin
3	ON/ $\overline{\text{OFF}}$	Power-off pin H: Normal operation (Step-down operation) L: Halts step-down operation (All circuits deactivated)
4	CSS	Soft start capacitor connection pin
5	VSS	GND pin
6	NDRV	N channel MOS connection pin
7	PDRV	P channel MOS connection pin
8	VIN	IC power supply pin

Absolute Maximum Ratings

(Ta = 25 °C unless otherwise specified)

Item	Symbol	Ratings	Unit	
VIN pin voltage	V _{IN}	V _{SS} -0.3 to V _{SS} +18	V	
VOUT pin voltage	V _{OUT}	V _{SS} -0.3 to V _{SS} +18	V	
SENSE pin voltage	V _{SENSE}	V _{SS} -0.3 to V _{SS} +18	V	
ON/ $\overline{\text{OFF}}$ pin voltage	V _{ON/$\overline{\text{OFF}}$}	V _{SS} -0.3 to V _{SS} +18	V	
CSS pin voltage	V _{CSS}	V _{SS} -0.3 to V _{IN} +0.3	V	
VNDRV pin voltage	V _{NDRV}	V _{SS} -0.3 to V _{IN} +0.3	V	
VPDRV pin voltage	V _{PDRV}	V _{SS} -0.3 to V _{IN} +0.3	V	
P,NDRV pin current	I _{PDRV} I _{NDRV}	±100	mA	
Power dissipation	P _D	8-pin TSSOP	300	mW
		8-pin SON(B)		
Operating temperature range	T _{opr}	-40 to +85	°C	
Storage temperature range	T _{stg}	-40 to +125	°C	

Note: Although the IC contains protection circuit against static electricity, excessive static electricity or voltage which exceeds the limit of the protection circuit should not be applied to.

■ Electrical Characteristics

$V_{IN} = V_{OUT} \times 1.5$ [V], $I_{OUT} = V_{OUT} / 50$ [A] (In case $V_{OUT} \leq 1.8$ [V], $V_{IN} = 2.7$ [V]) ($T_a = 25$ °C, unless otherwise specified)

Parameter	Symbol	Conditions	Min.	Typ.	Max.	Units	Measurement Circuit
Output voltage *1	$V_{OUT(E)}$		$V_{OUT(S)} \times 0.98$	$V_{OUT(S)}$	$V_{OUT(S)} \times 1.02$	V	2
Input voltage	V_{IN}		2.7	–	16.0	V	1
Current consumption 1	I_{SS1}	No external components, $V_{OUT} = V_{OUT(S)} \times 0.95$ (Duty ratio 100%)	–	50	140	μA	1
Current consumption during power-off	I_{SSS}	ON/OFF pin = 0V	–	–	1.0	μA	1
PDRV pin output current	I_{PDRVH}	No external components, $V_{OUT} = V_{OUT(S)} \times 1.5$, $V_{IN} = 9.0V$, $V_{PDRV} = V_{IN} - 0.2V$	-12	-18	–	mA	1
	I_{PDRVL}	No external components, $V_{OUT} = V_{OUT(S)} \times 0.95$, $V_{IN} = 9.0V$, $V_{PDRV} = V_{IN} - 0.2V$	19	27	–	mA	1
NDRV pin output current	I_{NDRVH}	No external components, $V_{OUT} = V_{OUT(S)} \times 1.5$, $V_{IN} = 9.0V$, $V_{NDRV} = V_{IN} - 0.2V$	-10	-14	–	mA	1
	I_{NDRVL}	No external components, $V_{OUT} = V_{OUT(S)} \times 0.95$, $V_{IN} = 9.0V$, $V_{NDRV} = V_{IN} - 0.2V$	15	21	–	mA	1
Line regulation	ΔV_{OUT1}	$V_{IN} = V_{OUT(S)}$ S-8532B15A to 29A	–	$V_{OUT(E)} \times 1.0 \%$	$V_{OUT(E)} \times 2.5 \%$	V	2
		$\times 1.2$ to 16V S-8532B30A to 60A	–	$V_{OUT(E)} \times 1.0 \%$	$V_{OUT(E)} \times 2.0 \%$	V	2
Load regulation	ΔV_{OUT2}	$I_{OUT} = 10\mu A$ to I_{OUT} (see above) $\times 1.25$	–	$V_{OUT(E)} \times 0.5 \%$	$V_{OUT(E)} \times 1.0 \%$	V	2
Output voltage temperature coefficient	$\frac{\Delta V_{OUT}}{\Delta T_a \bullet V_{OUT}}$	$T_a = 40^\circ C$ to $85^\circ C$	–	± 100	–	ppm/ °C	–
Oscillation frequency	fosc	Measure waveform at the PDRV pin.	255	300	345	kHz	2
Maximum duty ratio	MaxDuty	See I_{SS1} . Measure waveform at the PDRV pin.	100	–	–	%	1
Current limiting detection current	V_{SENSE}	See I_{SS1} .	100	125	150	mV	1
SENSE pin input current	I_{SENSE}	See I_{SS1} . $V_{SENSE} = V_{IN} - 0.1V$	5.0	13.0	20.0	μA	1
V_{OUT} pin input current	I_{VOUT}	See I_{SS1} .	5.0	13.0	20.0	μA	1
ON/OFF pin input voltage	V_{SH}	See I_{SS1} . $V_{IN} = 2.7V$ and check that $V_{PDRV} = "L"$.	1.8	–	–	V	1
	V_{SL}	See I_{SS1} . $V_{IN} = 16.0V$ and check that $V_{PDRV} = "H"$.	–	–	0.3	V	1
ON/OFF pin input leakage current	I_{SH}	See I_{SS1} . $V_{ON/OFF} = V_{IN}$.	–	–	0.1	μA	1
	I_{SL}	See I_{SS1} . $V_{ON/OFF} = 0V$.	–	–	-0.1	μA	1
Soft-Start time	T_{SS}	See I_{SS1} . Measure time until PDRV pin oscillates.	5.0	8.0	16.0	ms	1
Efficiency	EFFI	*2, $I_{OUT} = 400mA$ to $600mA$, S-8532B33A	–	90	–	%	3

External components:

Coil:	Sumida	CD105 (22 μH)
Diode:	Panasonic	MA2Q737 (Schottky diode)
Capacitor:	Nichicon	F93 (16 V, 47 μF, tantalum) $\times 2$
Transistor:	Toshiba	2SA1213-Y
Base resistor:		1 kΩ
Base capacitor:		2200 pF
CSS:		4700 pF
CNDRV:		1000 pF

*1: $V_{OUT(S)}$: Nominal output voltage value

$V_{OUT(E)}$: Actual output voltage value: $V_{IN} = V_{OUT} \times 1.5$ [V], $I_{OUT} = V_{OUT}/50$ [A] (If $V_{OUT} \leq 1.8$ [V], $V_{IN} = 2.7$ [V].)

*2: External components

Coil:	Sumida	CDRH124 (22 μH)
Capacitor:	Nichicon	F93 (16 V, 47 μF, tantalum) $\times 2$
Pch POWER MOSFET:	Sanyo	CPH6302
Nch POWER MOSFET:	Sanyo	CPH6402
CSS:		4700 pF

■ Measurement Circuits

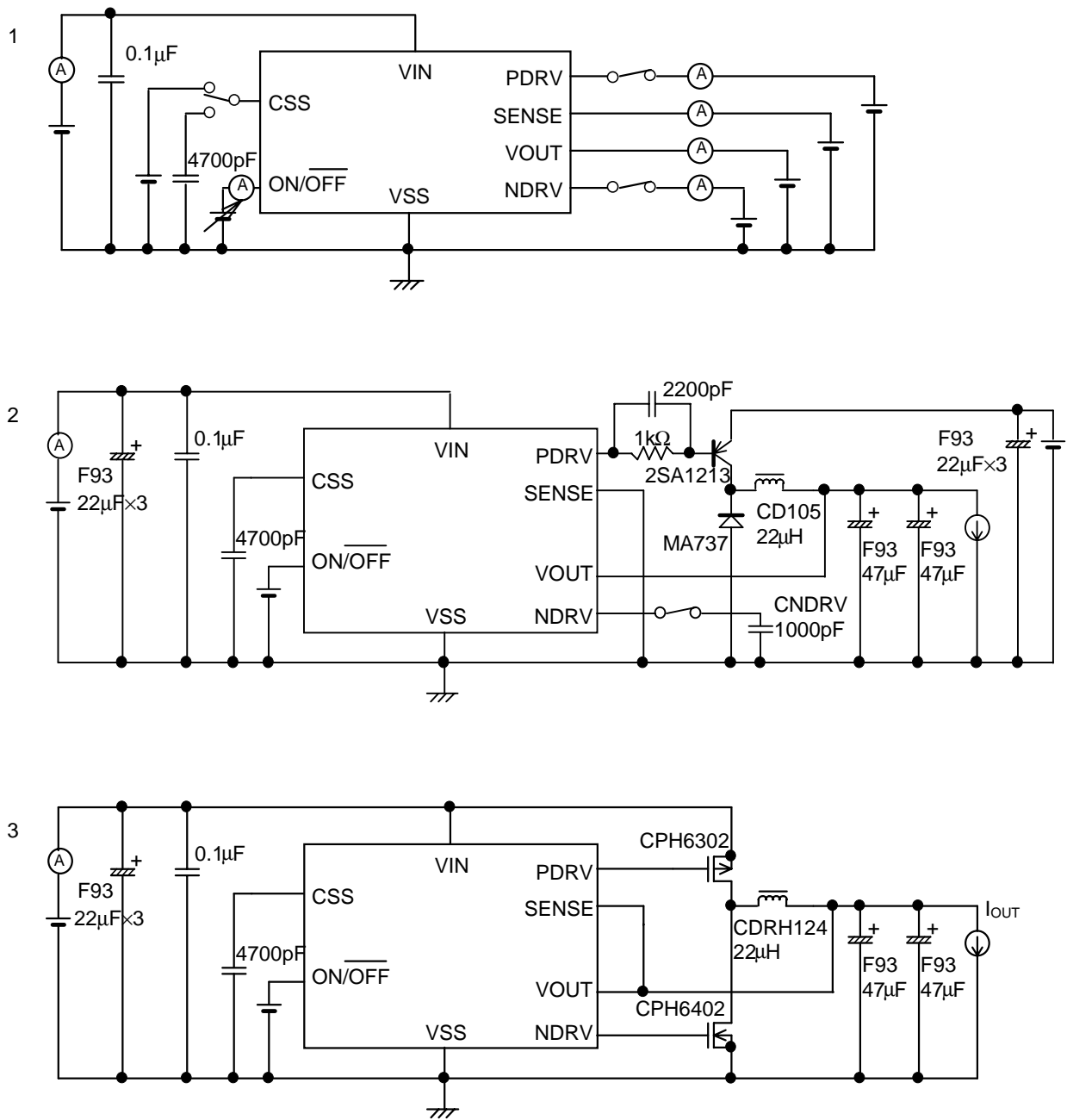

Figure 4

■ Operation

1. Synchronous step-down DC-DC converter

1.1 Synchronous rectification

A synchronous DC-DC converter can reduce power consumption which consumed by an external rectifying element compared to conventional (non-synchronous) DC-DC converters. The S-8532 series contains a circuit which prevents both the external MOSFETs from being turned on at the same time to reduce power consumption.

1.2 PWM Control

In pulse frequency modulation (PFM) DC/DC converters, pulses are skipped when they operate at low output current, causing variations in the ripple frequency of the output voltage and increase in the ripple voltage both of which constitute inherent drawbacks to these converters.

The S-8532 series uses pulse width modulation (PWM) and is characterized by its low current consumption.

In the S-8532 series, the pulse width varies in the range from 0% to 100% according to the load current, yet the ripple voltage produced by the switching can easily be removed by a filter since the switching frequency is always constant. These converters thus provide low-ripple output voltage over wide range of input voltage and load current.

2. Power-off Function

This function activates and deactivates the step-down operation and is controlled by the power-off pin (ON/ $\overline{\text{OFF}}$ pin). When the power-off pin is set "L", the voltage of the PDRV pin goes to V_{IN} level and voltage of the NDRV pin goes to V_{SS} level to shut off both the MOSFETs. All the internal circuits stop working, and substantial saving in current consumption is thus achieved.

The power-off pin has configuration shown in Figure 5. Since pull-up or pull-down is not performed internally, operation where the power-off pin is in a floating state should be avoided. Application of a voltage of 0.3V to 1.8V to the pin should also be avoided lest the current consumption increases. When the power-off pin is not used, it should be connected to the VIN pin.

Power-off Pin	CR Oscillation Circuit	Output Voltage
"H"	Active	Set value
"L"	Non-active	OPEN

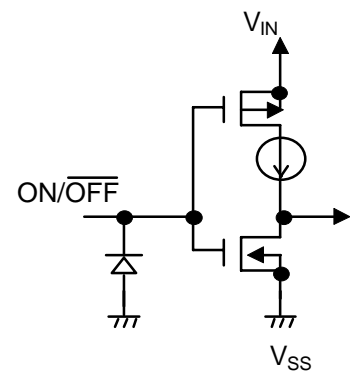

Figure 5

3. Soft-Start Function

The S-8532 series has a built-in soft-start circuit. This circuit enables the output voltage to ramp gradually over the specified soft-start time to suppress the overshooting of the output voltage, when the power is switched on or the ON/ $\overline{\text{OFF}}$ pin is set "H".

The soft-start time can be set with an external capacitor (CSS). The capacitance value of the CSS should be selected so as to make enough soft-start time for the power rising time. If the CSS value is not enough, output voltage overshooting, input current rushing or IC malfunction may occur. The time needed for output voltage (V_{OUT}) to reach 95% of the set value is calculated by the following formula.

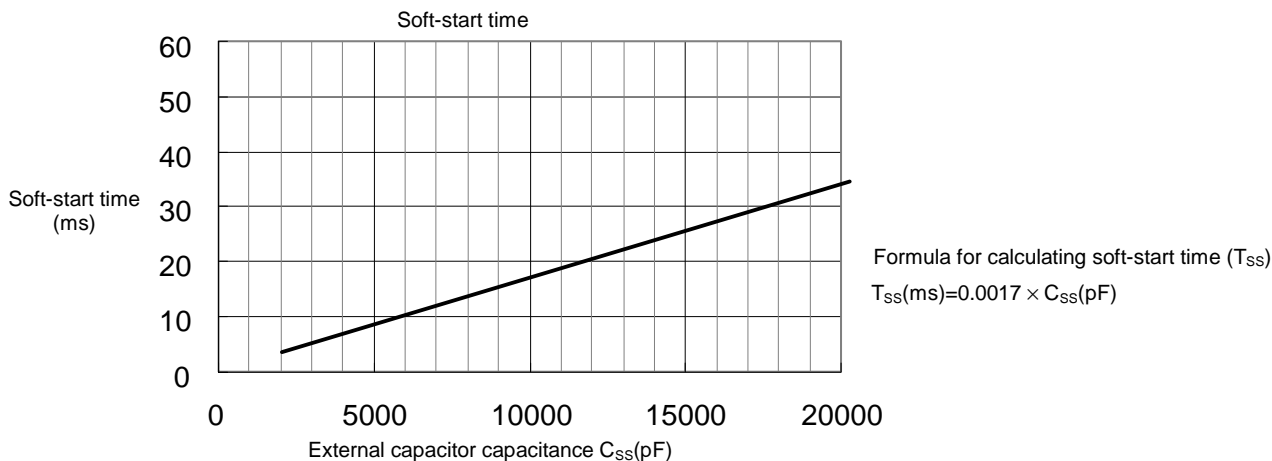

Figure 6 Soft-start time vs. external capacitor

4. Current limit circuit

The S-8532 series contains current limit circuit. The purpose of the current limit circuit is to prevent the external MOSFETs from thermal destruction due to overload or magnetic saturation of the coil.

The current limit circuit can be enabled by inserting a sense resistor (R_{SENSE}) between the coil and the output pin V_{OUT} and connecting the node for the sense resistor and the coil to the SENSE pin. (See the standard circuit shown in Fig. 10.)

A current limit comparator in the IC is used to check whether the voltage between the SENSE pin and V_{OUT} pin reaches the current limit detection voltage ($V_{\text{SENSE}} = 125\text{mV}(\text{typ.})$). The current flowing through the external transistor is limited by turning it off during the left time of the oscillation period after detection. The transistor is turned on again at the next clock and current limit detection resumes. If the overcurrent state still persists, the current limit circuit operates again, and the process is repeated. If the overcurrent state is eliminated, the normal operation resumes. Slight overshoot occurs in the output voltage when the overcurrent state is eliminated.

I_{Limit} (current limit setting value) is calculated by the following formula :

$$I_{\text{Limit}} (\text{current limit setting value}) = \frac{V_{\text{sense}} (= 125\text{mV})}{R_{\text{sense}}}$$

If the change with time of the current flowing through the sense resistor is higher than the response speed of the current limit comparator in the IC, the actual current limit value becomes higher than the I_{Limit} (current limit setting value) calculated by the above formula. When the voltage difference between V_{IN} and V_{OUT} is large, the actual current limit value increases since the change with time of the current flowing through the sense resistor becomes large.

An example of a 1.5V product is given below.

Input voltage vs. coil peak current
 (Measure I_{peak} when the current limiting circuit activates (V_{OUT} begins to fall))
 CDRH22μH Load resistance = 1.0 Ω R_{sense} = 100 mΩ

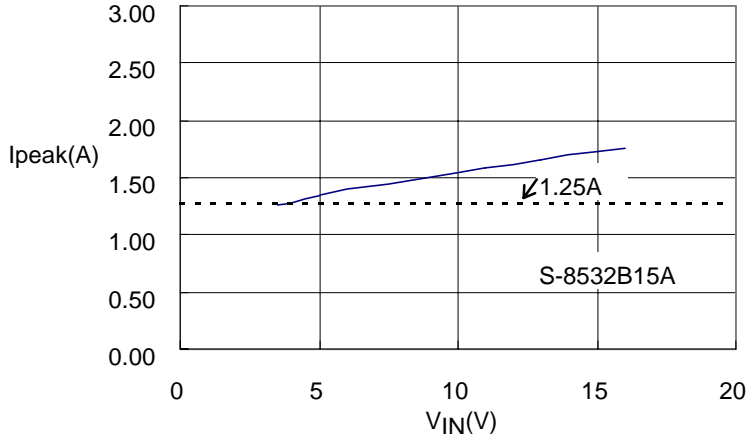

Figure 7 I_{peak} change by input voltage (1.5V model)

When the output voltage is approximate 1.0 V or less, load short-circuit protection cannot be carried out since the current limit circuit does not operate.

When the current limit circuit is not used, remove the sensor resistor and connect the SENSE pin to the VSS or VOUT pin.

5. 100% Duty Cycle

The S-8532 series operates up to the maximum duty cycle of 100%. The switching transistor is kept on continuously to supply current to the load, when the input voltage falls below the preset output voltage value. The output voltage in this case is equal to the subtraction of the lowering due to the DC resistance of the coil and the on resistance of the switching FET from the input voltage.

6. Back-flow current

Since the S-8532 series performs PWM synchronous rectification under a light load, current flows back to the VIN direction. And the back-flow current is the biggest when there is no load (see Fig. 8.). Since the maximum back-flow current value is calculated by the following equation, attention should be paid to.

$$\text{Duty}(I_{\text{OUT}}=0) = V_{\text{OUT}} / V_{\text{IN}}$$

Example: $V_{\text{IN}}=5\text{V}, V_{\text{OUT}}=3\text{V}, \text{Duty}=60\%$

$$\Delta I_L = \Delta V / L \times \text{ton} = (V_{\text{IN}} - V_{\text{OUT}}) \times \text{Duty} / (L \times f_{\text{osc}}) \times 1.2$$

Example: $V_{\text{IN}}=5\text{V}, V_{\text{OUT}}=3\text{V}, f_{\text{osc}}=300\text{kHz}, L=22\mu\text{H}, \Delta I_L=218\text{mA}$

$$I_{L\text{max}} = \Delta I_L / 2 = 109\text{mA}, I_{L\text{min}} = -\Delta I_L / 2 = -109\text{mA}$$

When there is no load, the coil current becomes triangular wave with I_{Lmax} the maximum and I_{Lmin} the minimum which is negative. The negative current, hatched parts in Fig. 9, flows backward.

When the output current (I_{OUT}) is approximately 109mA under the above conditions, the current does not flow backward since the minimum value (I_{Lmin}) of the triangular wave becomes 0mA. When an input capacitor (C_{IN}) is installed, back-flow current to the power source is negligible since the back-flow current is absorbed by the input capacitor. The input capacitor is indispensable to reduce back-flow current to the power source.

Though the fore mentioned conditions are required to prevent back-flow current, they are guidelines. Please check the validity by measuring the prototype or the actual device.

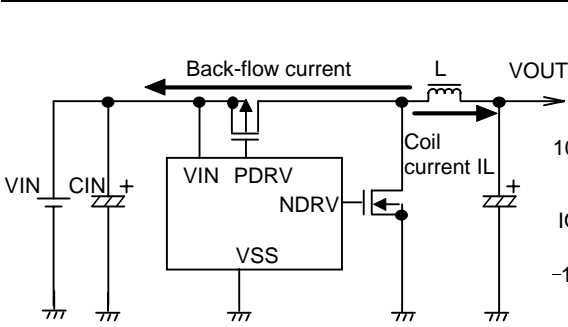

Figure 8 Back-flow current

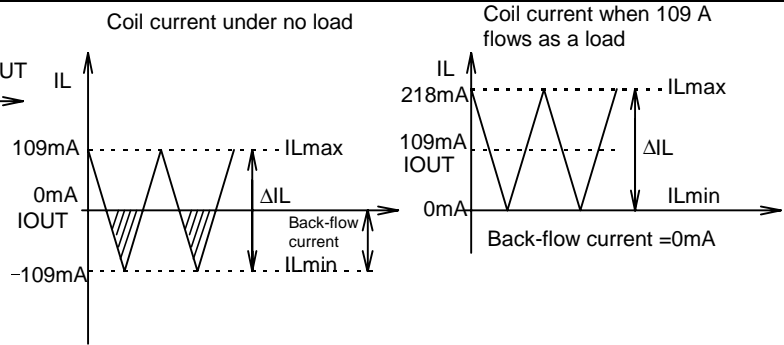

Figure 9 Example for no back-flow current

■ Selection of External Components

1. Inductor

The inductance value L greatly affects the maximum output current I_{OUT} and the efficiency η.

As the Inductance is reduced gradually, the peak current I_{pk} increases, and the output current I_{OUT} reaches the maximum at a certain Inductance value. As the Inductance is made even smaller, I_{OUT} begins to decrease since the current drivability of the switching transistor becomes insufficient.

Conversely, as the Inductance is increased, the loss in the switching transistor due to I_{PK} decreases, and the efficiency reaches the maximum at a certain Inductance value. As the Inductance is made even larger, the efficiency degrades since the loss due to the series resistance of the inductor increases.

In many applications an inductance of 22μH will yield the best characteristics of the S-8532 series in a well balanced manner.

When choosing an inductor, attention to its allowable current should be paid since the current applied over the allowable value will cause magnetic saturation in the inductor, leading to a marked decline in efficiency.

An inductor should therefore be selected so as not the peak current I_{PK} to surpass its allowable current. The peak current I_{PK} is expressed by the following equation:

$$I_{PK} = I_{OUT} + \frac{V_{OUT} \times (V_{IN} - V_{OUT})}{2 \times f_{osc} \times L \times V_{IN}}$$

where f_{osc} (=300 kHz) is the oscillation frequency and L is the inductance value of the inductor.

2. Capacitors (C_{IN}, C_{OUT})

The capacitor (C_{IN}) inserted on the input side serves to reduce power impedance, average input current and suppress back-flow current to the power source. Choose the C_{IN} value according to the impedance of the power source used, and choose a capacitor with a large capacitance and a low ESR (Equivalent Series Resistance). It should be 47 to 100 μF, although the actual value depends on the impedance of the power source used and load current value. When the input voltage is low and the load is large, the output voltage may become unstable. In this case increase the input capacitance.

For the output side capacitor (C_{OUT}), select a large capacitance with low ESR (Equivalent Series Resistance) to smoothen the ripple voltage. When the input voltage is extremely high or the load current is extremely large, the output voltage may become unstable. In this case the unstable area will become narrow by selecting a large capacitance for an output side capacitor. A tantalum electrolytic capacitor is recommended since the unstable area widens when a capacitor with a large ESR, such as an aluminum electrolytic capacitor, or a capacitor with a small ESR, such as a ceramic capacitor, is chosen. The range of the capacitance should generally be 47μF to 100μF.

When selecting an input capacitor and an output capacitor, evaluate them by testing under the actual conditions.

3. External Switching Transistor

Enhancement (Pch, Nch) MOSFETs are recommended as external switching transistors for the S-8532 series.

3.1 Enhancement MOSFET

The PDRV/NDRV pin of the S-8532 series is capable of directly driving a Pch or Nch power MOSFET with a gate capacity around 1000pF.

When a Pch/Nch power MOSFETs are chosen, efficiency will be 2 to 3% higher than that achieved by bipolar transistor since MOSFET switching speeds are higher than PNP/NPN bipolar transistors and power losses due to the base current are avoided.

The important parameters in selecting Pch/Nch power MOSFETs are the threshold voltage, breakdown voltage between gate and source, breakdown voltage between drain and source, total gate capacity, on-resistance, and the current ratings.

The PDRV/NDRV pin swings from voltage V_{IN} over to voltage V_{SS} . If the input voltage is low, a MOSFET with a low threshold voltage has to be used so that the MOSFET will turn on as required. If, conversely, the input voltage is high, select a MOSFET whose gate-source breakdown voltage is higher than the input voltage by at least several volts.

Immediately after the power is turned on, or when the power is turned off (that is, when the step-down operation is terminated), the input voltage will be applied across the drain and the source of the MOSFET. The transistor therefore needs to have drain-source breakdown voltage that is also several volts higher than the input voltage.

The total gate capacity and the on-resistance affect the efficiency.

The power loss for charging and discharging the gate capacity by switching operation will affect the efficiency especially at low load current region when the total gate capacity becomes larger and the input voltage becomes higher. If the efficiency at low load is a matter of concern, select a MOSFET with a small total gate capacity.

In regions where the load current is high, the efficiency is affected by power losses caused by the on-resistance of the MOSFET. If the efficiency under heavy load is particularly important in the application, choose a MOSFET having on-resistance as low as possible.

As for the current rating, select a MOSFET whose maximum continuous drain current rating is higher than the peak current I_{PK} .

If an external Pch MOSFET has much different characteristics (input capacitance, V_{th} , etc.) from an external Nch MOSFET, they turn ON at the same time, flowing a through current and reducing efficiency. If a MOSFET with a large input capacitance is used, switching loss increases and efficiency decreases. If it is used at several hundreds of mA or more, the loss at the MOSFET increases and may exceed the permissible loss of the MOSFET. To select Pch and Nch MOSFETs, evaluate the performance by testing under the actual condition. If the load current is large, the Pch MOSFET loss increases and heat is generated. Pay attention to dissipate heat from the Pch MOSFET.

For reference, some efficiency data is included in this document. For applications with an input voltage range of 6 to 8 V or less, data was obtained by using Sanyo CPH6303, CPH6403, and Siliconix Si3441DV, Si3442DV, and for applications with an input voltage range of 6 to 8 V or more, data was obtained by using Sanyo CPH6302, CHP6402, and Siliconix Si3454DV, Si3455DV. See "Reference Data".

Current flow in the parasitic diode is not allowed in some MOSFETs. In this case, a schottky diode must be connected in parallel to the MOSFET. The schottky diode must have a low forward voltage, a high switching speed, a reverse-direction withstand voltage of V_{IN} or higher, and a current rating of I_{PK} or higher.

■ Standard Circuits

- Using MOSFET transistors

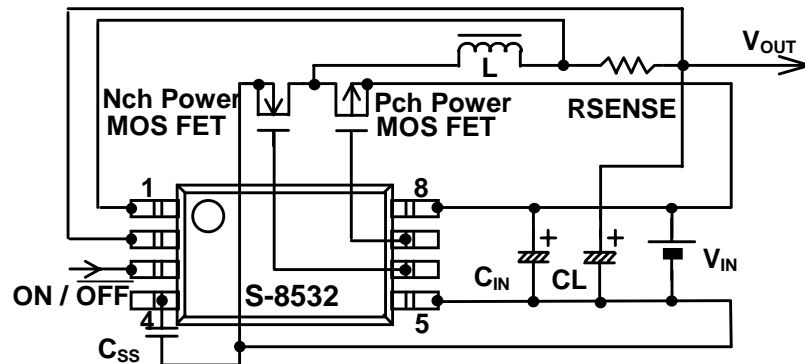

Figure 10

■ Precautions

- Install the external capacitors, diode, coil, and other peripheral components as close to the IC as possible, and make a one-point grounding.
- Normally, the Pch and Nch MOSFETs do not turn ON at the same time. However, if the external Pch MOSFET has much different characteristics (input capacitance, V_{th} , etc.) from the external Nch MOSFET, they may turn ON at the same time, flowing a through current. Select Pch and Nch transistors with similar characteristics.
- Any switching regulator intrinsically produces ripple voltage and spike noise, which are largely dictated by the coil and capacitors in use. When designing a circuit, first test them under actual condition.
- If the input voltage is high and output current is low, pulses with a low duty ratio may be output, and then the duty ratio may be 0% for several clocks. In this case, it changes to the pseudo pulse frequency modulation (PFM) mode, but the ripple voltage hardly increases.
- The PDRV and NDRV oscillation frequencies may be an integer fraction of 300 kHz at some input voltage and load condition.
- The through current prevention circuit reduces through current by shifting the Pch and Nch transistor on timing. It does not suppress the through current in the external transistors completely.
- The current limit circuit of this IC limits current by detecting the voltage difference of the external resistor RSENSE. In choosing the components, make sure that the overcurrent will not surpass the allowable dissipation of the switching transistor and inductor.
- Since PWM synchronous rectification is performed even when the load is light, current flows back to V_{IN} . Check whether the back-flow occurs and whether it affects the performance. (See 6. Back-flow current.)
- The PDRV or NDRV oscillation frequency may vary in a voltage range, depending on input voltage.
- Make sure that dissipation of the switching transistor will not surpass the allowable power dissipation of the package. (especially at high temperature)

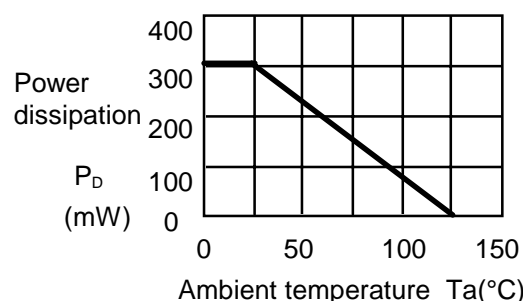
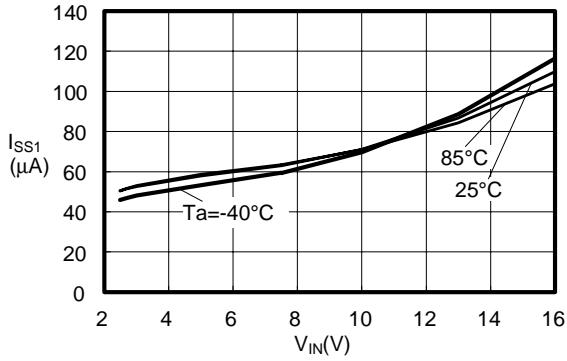

Figure 11 8-pin TSSOP, 8-pin SON(B) Package Power Dissipation in Free Air

- Seiko Instruments Inc. shall bear no responsibility for any patent infringement by a product that includes an IC manufactured by Seiko Instruments Inc. in relation to the method of using the IC in that product, the product specifications, or the destination country.

■ Characteristics of Major Parameters (Typical values)

(1) $I_{SS1}-V_{IN}$



(2) $F_{OSC}-V_{IN}$

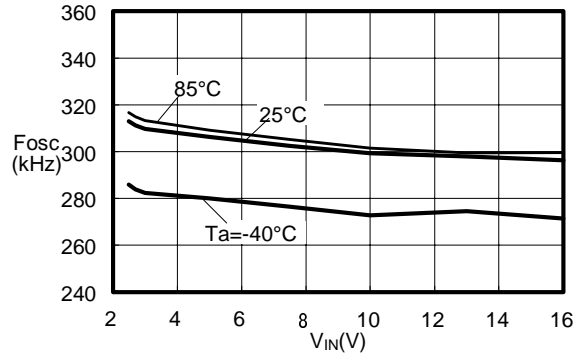

(3) $I_{PDRVH}-V_{IN}$

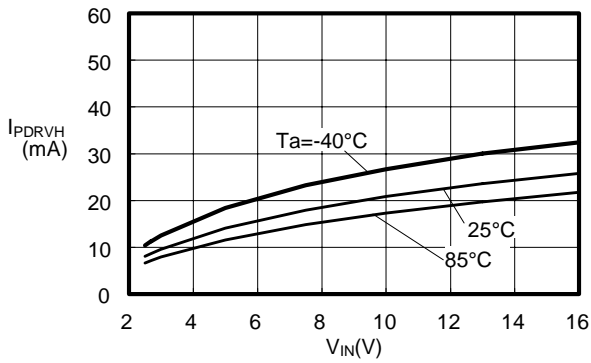

(4) $I_{PDRVL}-V_{IN}$

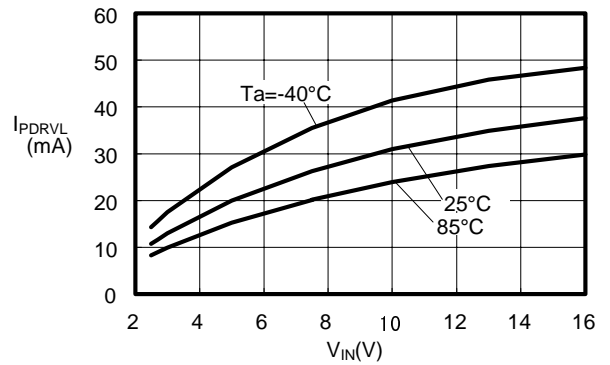

(5) $I_{NDRVH}-V_{IN}$

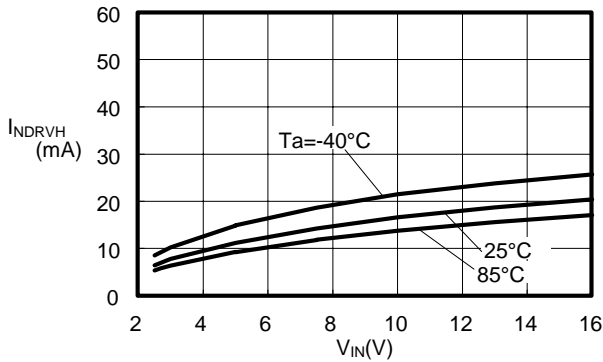

(6) $I_{NDRVL}-V_{IN}$

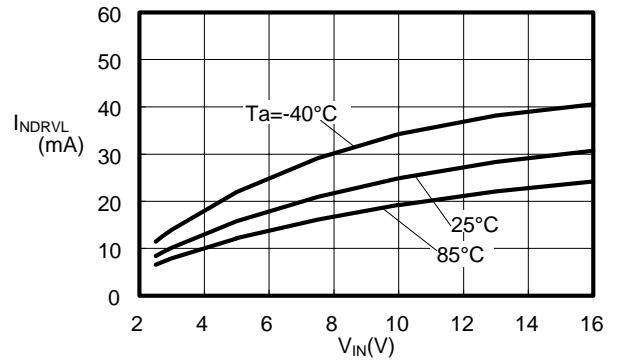

(7) $V_{SH}-V_{IN}$

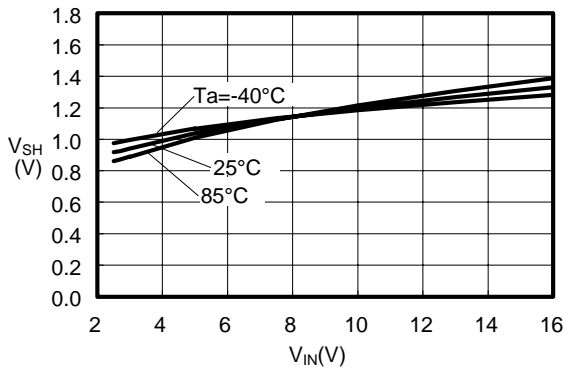

(8) $V_{SL}-V_{IN}$

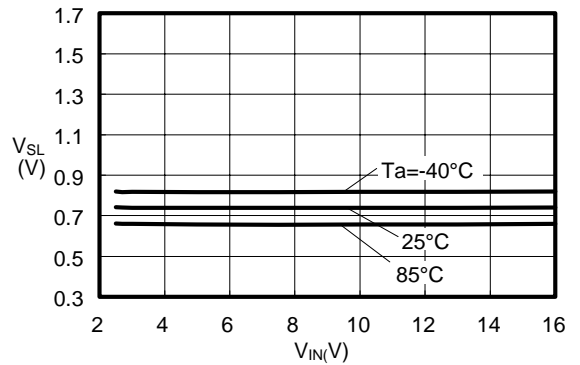

(9) $T_{SS}-V_{IN}$

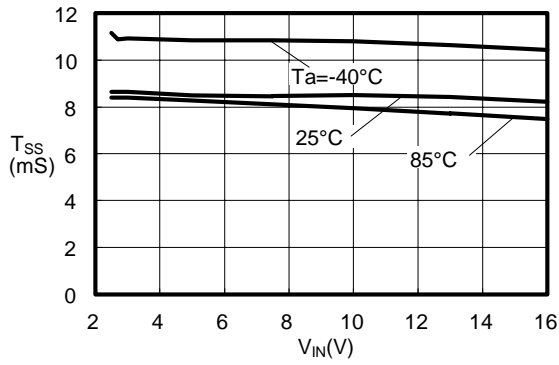

(10) $V_{OUT}-V_{IN}$

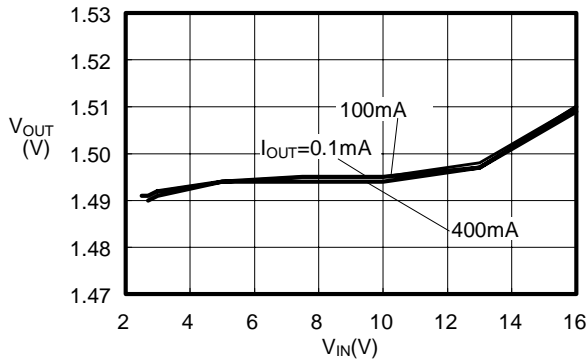

(11) $V_{OUT}-V_{IN}$

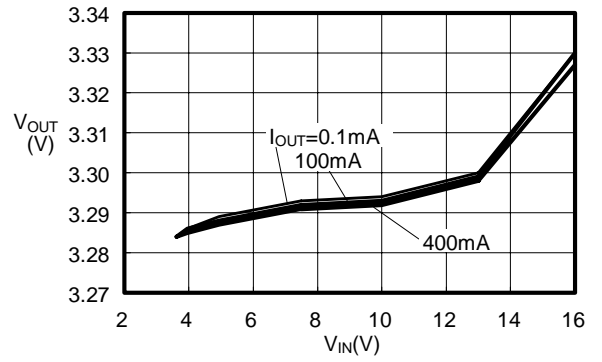

(12) $V_{OUT}-V_{IN}$

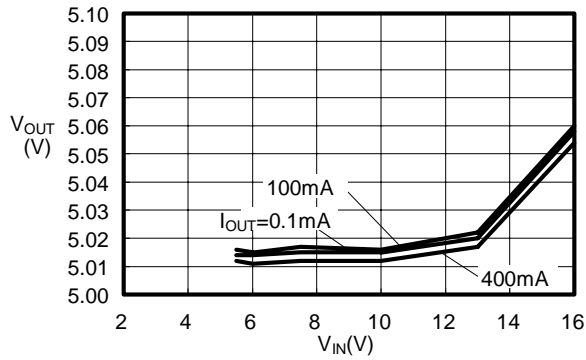

■ **Transient Response Characteristics**

1. V_{IN} (V_{IN} : 0V→2.7V or 5.0V or 7.5V, 0V→9.0V I_{OUT} : No LOad)

(1) S-8532B15AFT (V_{IN} : 0→2.7V)

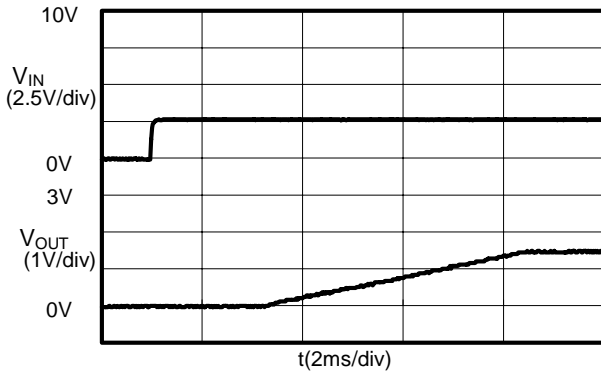

(2) S-8532B15AFT (V_{IN} : 0→9.0V)

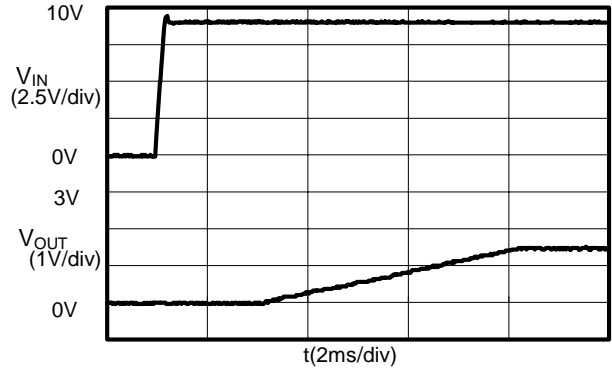

(3) S-8532B33AFT (V_{IN} : 0→5.0V)

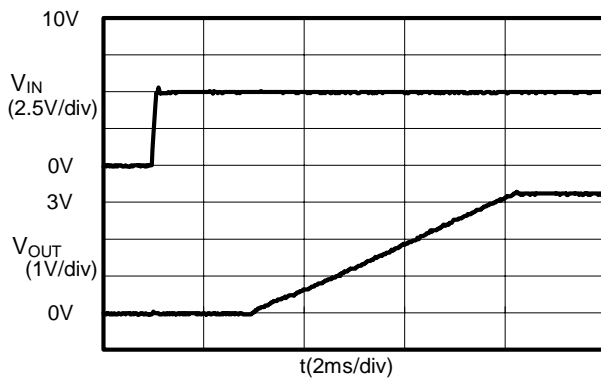

(4) S-8532B33AFT (V_{IN} : 0→9.0V)

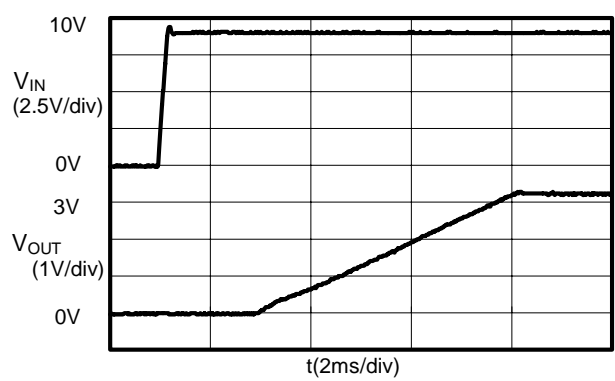

(5) S-8532B50AFT (V_{IN} : 0→7.5V)

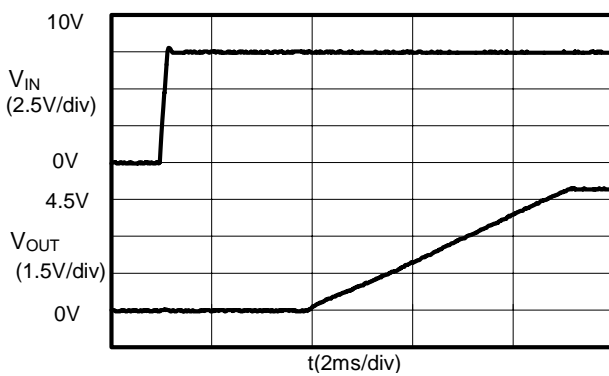

(6) S-8532B50AFT (V_{IN} : 0→9.0V)

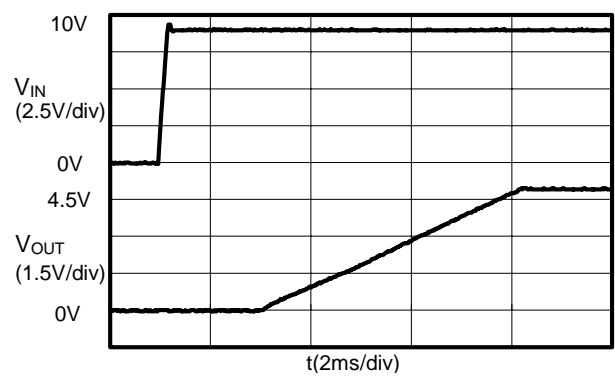

2. ON/OFF Terminal Response (ON/OFF:0V→1.8V I_{OUT}:No Load)

(1) S-8532B15AFT(V_{IN}:2.7V)

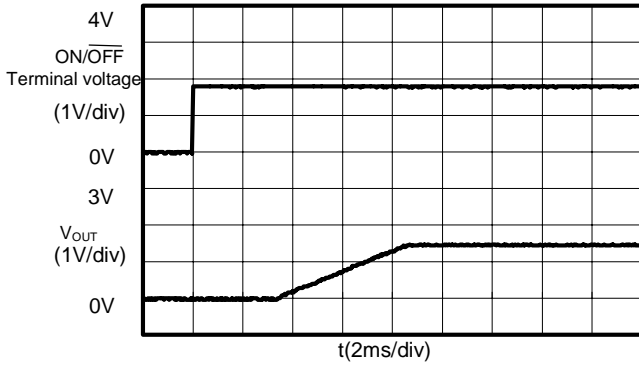

(2) S-8532B15AFT(V_{IN}:9.0V)

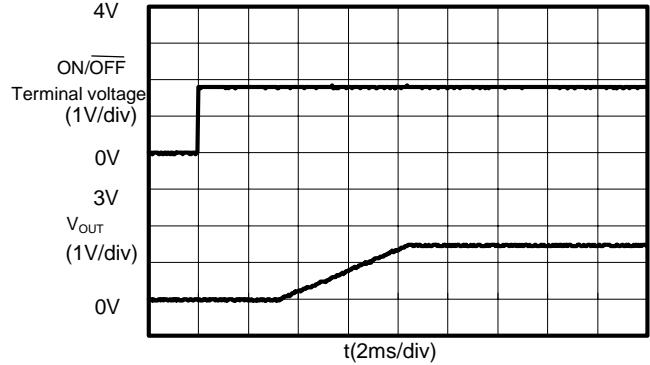

(3) S-8532B33AFT(V_{IN}:5.0V)

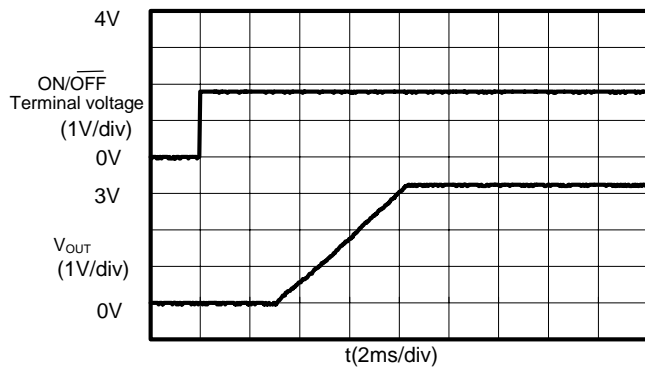

(4) S-8532B33AFT(V_{IN}: 9.0V)

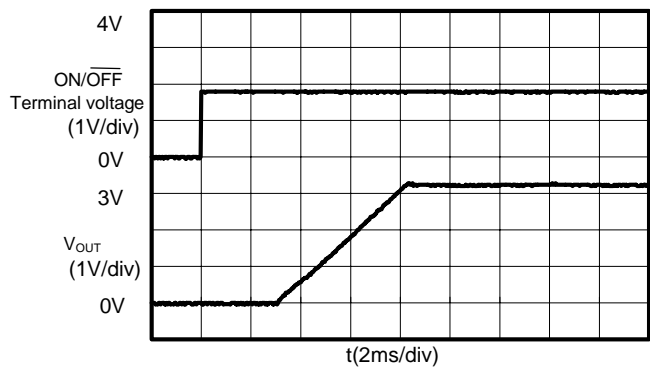

(5) S-8532B50AFT(V_{IN}: 7.5V)

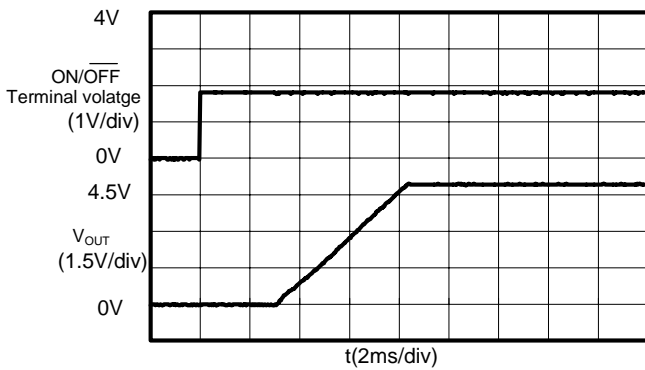

(6) S-8532B50AFT(V_{IN}: 9.0V)

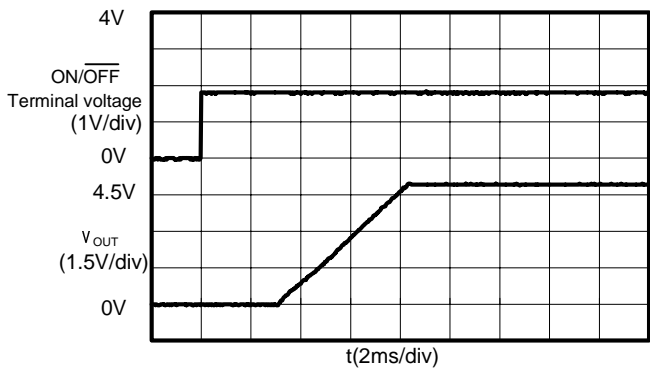

3. Supply Voltage Variation (V_{IN} : 2.7V→9.0V→2.7V, 5.0V→9.0V→5.0V, 7.5V→9.0V→7.5V)

(1) S-8532B15AFT (I_{OUT} : 10mA)

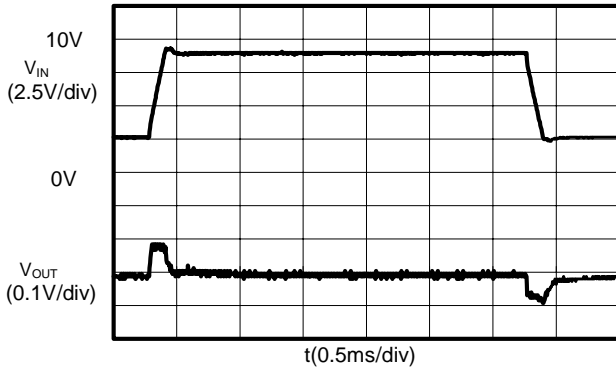

(2) S-8532B15AFT (I_{OUT} : 500mA)

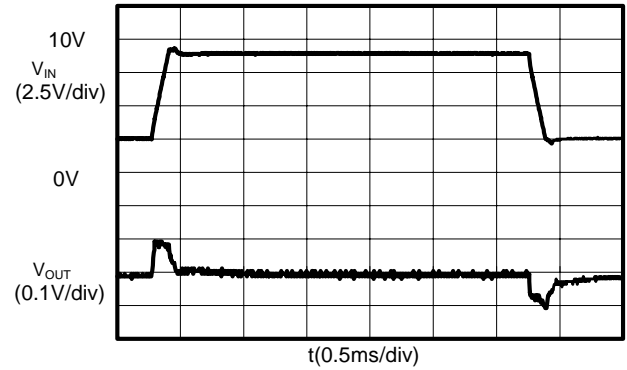

(3) S-8532B33AFT (I_{OUT} : 10mA)

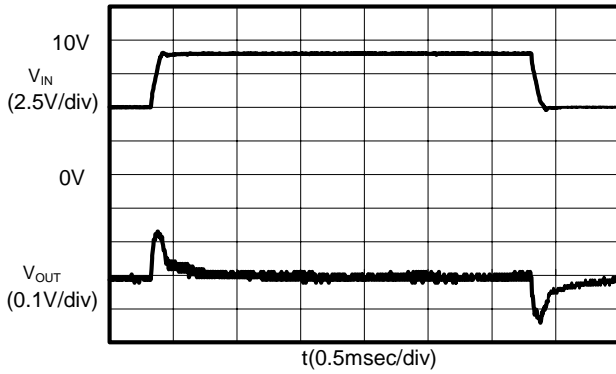

(4) S-8532B33AFT (I_{OUT} : 500mA)

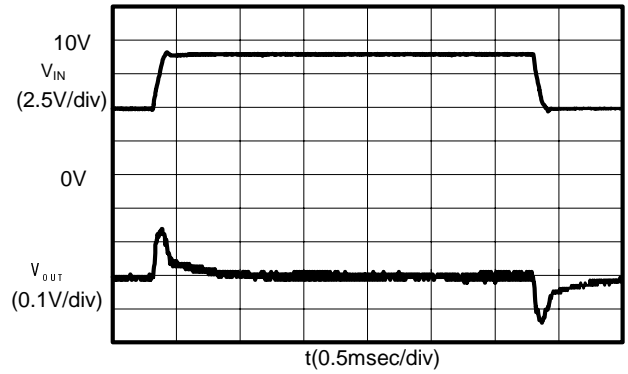

(5) S-8532B50AFT (I_{OUT} : 10mA)

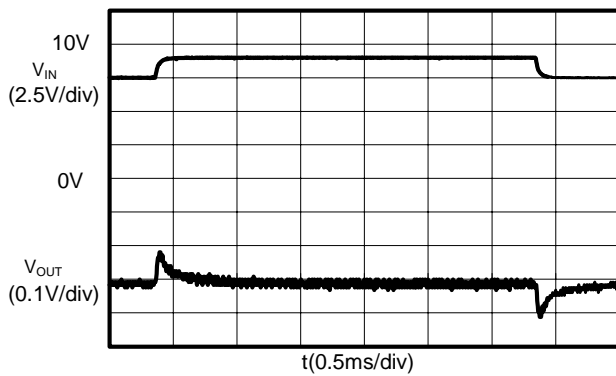

(6) S-8532B50AFT (I_{OUT} : 500mA)

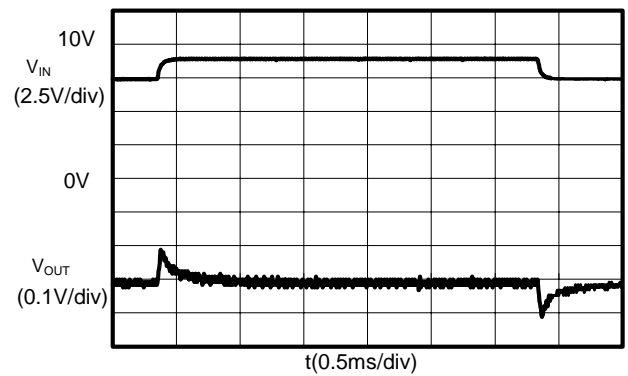

4. Load Variation (V_{IN} : 2.7V or 5.0V or 7.5V I_{OUT} : 0.1mA \rightarrow 500mA, 500mA \rightarrow 0.1mA)

(1) S-8532B15AFT (V_{IN} : 2.7V)

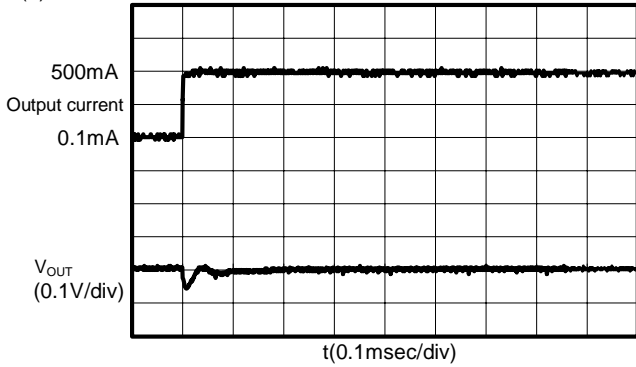

(2) S-8532B15AFT (V_{IN} : 2.7V)

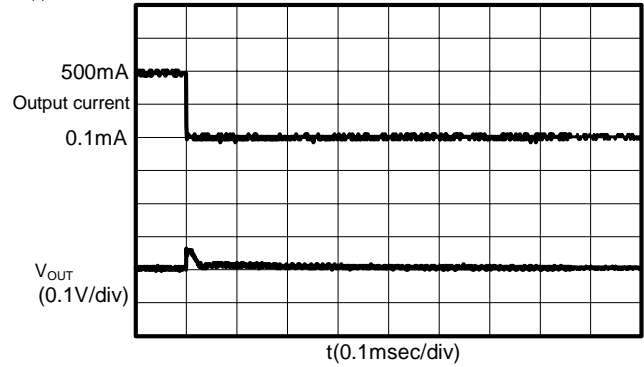

(3) S-8532B33AFT (V_{IN} : 5.0V)

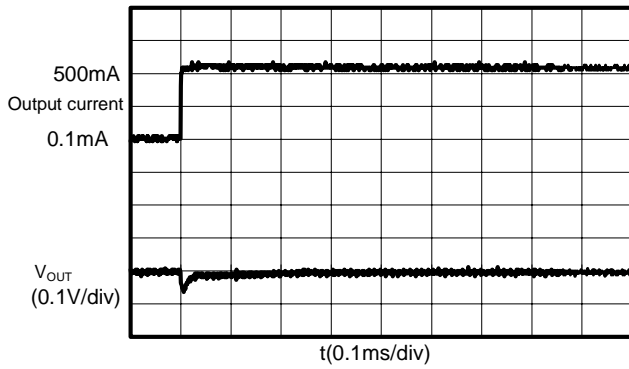

(4) S-8532B33AFT (V_{IN} : 5.0V)

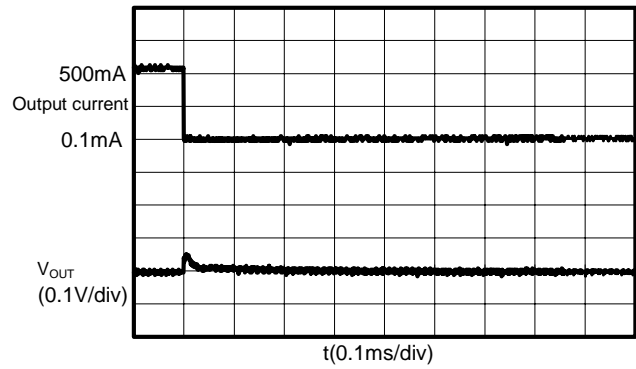

(5) S-8532B50AFT (V_{IN} : 7.5V)

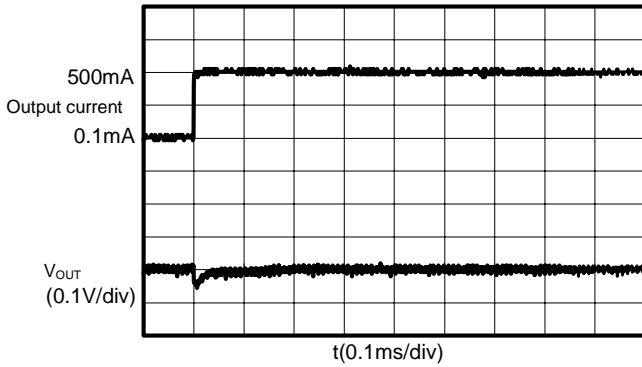

(6) S-8532B50AFT (V_{IN} : 7.5V)

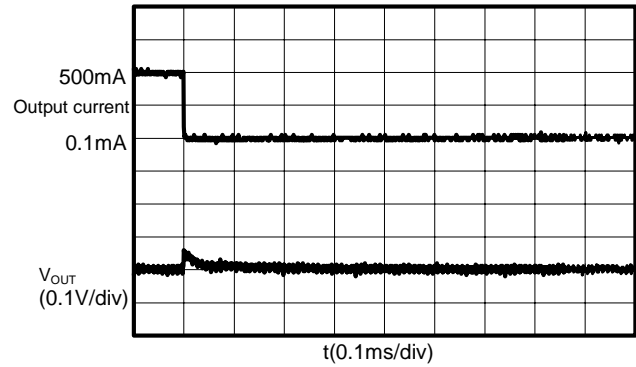

■ Reference Data

Reference data are intended for use in selecting peripheral components to the IC. The information therefore provides characteristic data in which external components are selected with a view of wide variety of IC applications. All data show typical values

External components list for efficiency vs output current characteristics

Table 1

No.	Product Name	V _{OUT}	Pch MOSFET	Nch MOSFET	Inductor	C _{OUT}	C _{IN}	R _{SENSE}	Application Condition
(1)	S-8532B15AFT	1.5V	CPH6303	CPH6403	CDRH124/22μH	47μF×2	47μF×2, 0.1μF	0Ω	I _{OUT} ≤2A, V _{IN} ≤8V
(2)	S-8532B15AFT	1.5V	Si3441	Si3442	CDRH124/22μH	47μF×2	47μF×2, 0.1μF	0Ω	I _{OUT} ≤1.6A, V _{IN} ≤6V
(3)	S-8532B33AFT	3.3V	CPH6303	CPH6403	CDRH124/22μH	47μF×2	47μF, 0.1μF	0Ω	I _{OUT} ≤2A, V _{IN} ≤8V
(4)	S-8532B33AFT	3.3V	Si3441	Si3442	CDRH124/22μH	47μF×2	47μF, 0.1μF	0Ω	I _{OUT} ≤1.6A, V _{IN} ≤6V
(5)	S-8532B33AFT	3.3V	CPH6302	CPH6402	CDRH124/22μH	47μF×2	47μF, 0.1μF	0Ω	I _{OUT} ≤2A, V _{IN} ≤16V
(6)	S-8532B33AFT	3.3V	Si3455	Si3454	CDRH124/22μH	47μF×2	47μF, 0.1μF	0Ω	I _{OUT} ≤1.6A, V _{IN} ≤16V
(7)	S-8532B50AFT	5.0V	CPH6302	CPH6402	CDRH124/22μH	47μF×2	47μF, 0.1μF	0Ω	I _{OUT} ≤2A, V _{IN} ≤16V
(8)	S-8532B50AFT	5.0V	Si3455	Si3454	CDRH124/22μH	47μF×2	47μF, 0.1μF	0Ω	I _{OUT} ≤1.6A, V _{IN} ≤16V
(9)	S-8532B15AFT	1.5V	CPH6303	CPH6403	CDRH124/47μH	47μF×2	47μF×2, 0.1μF	0Ω	I _{OUT} ≤2A, V _{IN} ≤8V
(10)	S-8532B15AFT	1.5V	Si3441	Si3442	CDRH124/47μH	47μF×2	47μF×2, 0.1μF	0Ω	I _{OUT} ≤1.6A, V _{IN} ≤6V
(11)	S-8532B33AFT	3.3V	CPH6303	CPH6403	CDRH124/47μH	47μF×2	47μF, 0.1μF	0Ω	I _{OUT} ≤2A, V _{IN} ≤8V
(12)	S-8532B33AFT	3.3V	Si3441	Si3442	CDRH124/47μH	47μF×2	47μF, 0.1μF	0Ω	I _{OUT} ≤1.6A, V _{IN} ≤6V
(13)	S-8532B33AFT	3.3V	CPH6302	CPH6402	CDRH124/47μH	47μF×2	47μF, 0.1μF	0Ω	I _{OUT} ≤2A, V _{IN} ≤16V
(14)	S-8532B33AFT	3.3V	Si3455	Si3454	CDRH124/47μH	47μF×2	47μF, 0.1μF	0Ω	I _{OUT} ≤1.6A, V _{IN} ≤16V
(15)	S-8532B50AFT	5.0V	CPH6302	CPH6402	CDRH124/47μH	47μF×2	47μF, 0.1μF	0Ω	I _{OUT} ≤2A, V _{IN} ≤16V
(16)	S-8532B50AFT	5.0V	Si3455	Si3454	CDRH124/47μH	47μF×2	47μF, 0.1μF	0Ω	I _{OUT} ≤1.6A, V _{IN} ≤16V
(17)	S-8532B15AFT	1.5V	CPH6303	CPH6403	CDRH124/10μH	47μF×2	47μF×2, 0.1μF	0Ω	I _{OUT} ≤2A, V _{IN} ≤8V
(18)	S-8532B15AFT	1.5V	Si3441	Si3442	CDRH124/10μH	47μF×2	47μF×2, 0.1μF	0Ω	I _{OUT} ≤1.6A, V _{IN} ≤6V
(19)	S-8532B33AFT	3.3V	CPH6303	CPH6403	CDRH124/10μH	47μF×2	47μF, 0.1μF	0Ω	I _{OUT} ≤2A, V _{IN} ≤8V
(20)	S-8532B33AFT	3.3V	Si3441	Si3442	CDRH124/10μH	47μF×2	47μF, 0.1μF	0Ω	I _{OUT} ≤1.6A, V _{IN} ≤6V
(21)	S-8532B33AFT	3.3V	CPH6302	CPH6402	CDRH124/10μH	47μF×2	47μF, 0.1μF	0Ω	I _{OUT} ≤2A, V _{IN} ≤16V
(22)	S-8532B33AFT	3.3V	Si3455	Si3454	CDRH124/10μH	47μF×2	47μF, 0.1μF	0Ω	I _{OUT} ≤1.6A, V _{IN} ≤16V
(23)	S-8532B50AFT	5.0V	CPH6302	CPH6402	CDRH124/10μH	47μF×2	47μF, 0.1μF	0Ω	I _{OUT} ≤2A, V _{IN} ≤16V
(24)	S-8532B50AFT	5.0V	Si3455	Si3454	CDRH124/10μH	47μF×2	47μF, 0.1μF	0Ω	I _{OUT} ≤1.6A, V _{IN} ≤16V
(25)	S-8532B33AFT	3.3V	CPH6303	CPH6403	CDRH124/10μH	47μF×2	47μF×2, 0.1μF	0Ω	I _{OUT} ≤3A, V _{IN} ≤8V*
(26)	S-8532B33AFT	3.3V	CPH6302	CPH6402	CDRH124/10μH	47μF×2	47μF×2, 0.1μF	0Ω	I _{OUT} ≤3A, V _{IN} ≤16V*

Note*: Inserting a 10Ω resistor between the VIN pin and the input voltage V_{IN}, measurement was done. Refer fig.12.

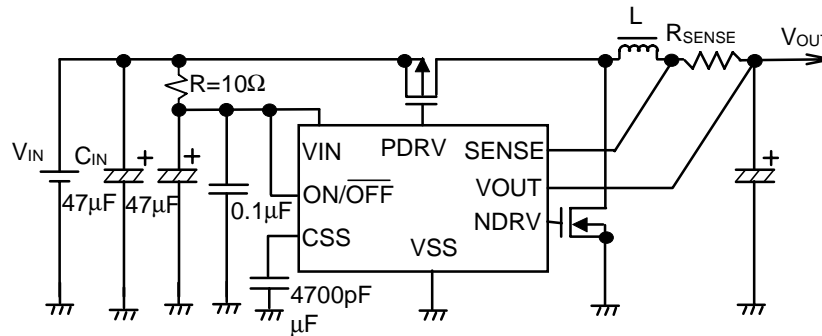

Fig.12

External components list for efficiency vs output current characteristics

Table 2

No.	Product Name	V _{OUT}	Pch MOSFET	Nch MOSFET	Inductor	C _{OUT}	C _{IN}	R _{SENSE}	Application Condition
(25)	S-8532B15AFT	1.5V	CPH6303	CPH6403	CDRH124/22µH	47µF×2	47µF×2, 0.1µF	0Ω	I _{OUT} ≤2A, V _{IN} ≤8V
(26)	S-8532B15AFT	1.5V	Si3441	Si3442	CDRH124/22µH	47µF×2	47µF×2, 0.1µF	0Ω	I _{OUT} ≤1.6A, V _{IN} ≤6V
(27)	S-8532B33AFT	3.3V	CPH6303	CPH6403	CDRH124/22µH	47µF×2	47µF, 0.1µF	0Ω	I _{OUT} ≤2A, V _{IN} ≤8V
(28)	S-8532B33AFT	3.3V	Si3441	Si3442	CDRH124/22µH	47µF×2	47µF, 0.1µF	0Ω	I _{OUT} ≤1.6A, V _{IN} ≤6V
(29)	S-8532B33AFT	3.3V	CPH6302	CPH6402	CDRH124/22µH	47µF×2	47µF, 0.1µF	0Ω	I _{OUT} ≤2A, V _{IN} ≤16V
(30)	S-8532B33AFT	3.3V	Si3455	Si3454	CDRH124/22µH	47µF×2	47µF, 0.1µF	0Ω	I _{OUT} ≤1.6A, V _{IN} ≤16V
(31)	S-8532B50AFT	5.0V	CPH6302	CPH6402	CDRH124/22µH	47µF×2	47µF, 0.1µF	0Ω	I _{OUT} ≤2A, V _{IN} ≤16V
(32)	S-8532B50AFT	5.0V	Si3455	Si3454	CDRH124/22µH	47µF×2	47µF, 0.1µF	0Ω	I _{OUT} ≤1.6A, V _{IN} ≤16V

Table 3 Performance Data

Parts	Product Name	Manufacturer	Inductance (µH)	DC Resistance(Ω)	Maximum Current (A)	Diameter (mm)	Height (mm)
Inductor	CDRH127	Sumida	47	0.10	2.5	12.0 typ. 12.2.max.	8.0 max.
	CDRH124	↑	22	0.066	2.9	12.0 typ.	4.5 max.
			10	0.028	4.5	12.3.max.	
Diode	MA737	Matsushita Electronics	Forward current 1.5A (@VF = 0.5V)				
Output Capacity	F93	Nichicon					
External Transistor (Pch MOSFET)	CPH6303	Sanyo Electric	VGS 10V max. , ID -4A max., Vth -0.4V min., C _{ISS} 820pF typ. Ron 0.090Ω max. (Vgs=-4V), SOT-23-6				
	CPH6302	↑	VGS 20V max. , ID -3A max., Vth -1.0V min., C _{ISS} 300pF typ. Ron 0.145Ω max. (Vgs=-10V), SOT-23-6				
	Si3441DV	Vishay Siliconix	VGS 8V max. , ID -3.3A max., Vth -0.45V min., Ron 0.10Ω max. (Vgs=-4.5V), TSOP-6				
	Si3455DV	↑	VGS 20V max. , ID -3.5A max., Vth -1.0V min., Ron 0.10Ω max. (Vgs=-10V), TSOP-6				
External Transistor (Nch MOSFET)	CPH6403	Sanyo Electric	VGS 10V max. , ID 6A max. , Vth 0.4 V min., C _{ISS} 700pF typ. Ron 0.038Ω max. (Vgs=4V), TSOP-6				
	CPH6402	↑	VGS 24V max. , ID 4A max. , Vth 1.0V min., C _{ISS} 240pF typ. Ron 0.075Ω max. (Vgs=10V), TSOP-6				
	Si3442DV	Vishay Siliconix	VGS 8V max. , ID 4.0A max. , Vth 0.6V min., Ron 0.070Ω max. (Vgs=4.5V), TSOP-6				
	Si3454DV	↑	VGS 20V max. , ID 4.2A max. , Vth 1.0V min., Ron 0.065Ω max. (Vgs=10V), TSOP-6				

1. Efficiency Characteristics

(1) S-8532B15AFT

Output current— Efficiency(CPH6303/CPH6403)

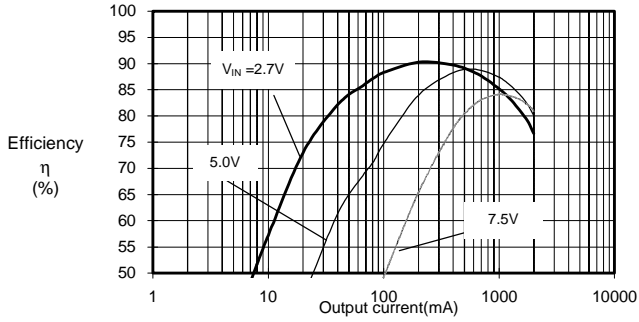

(2) S-8532B15AFT

Output current— Efficiency(Si3441DV/Si3442DV)

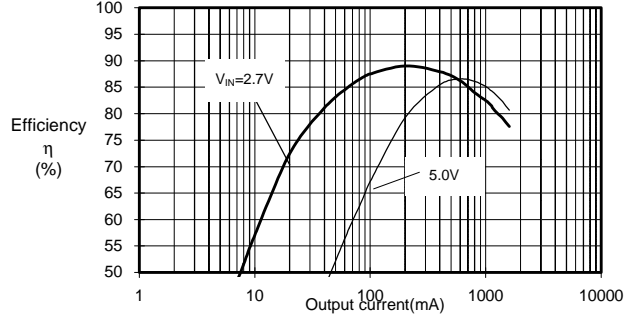

(3) S-8532B33AFT

Output current— Efficiency(CPH6303/CPH6403)

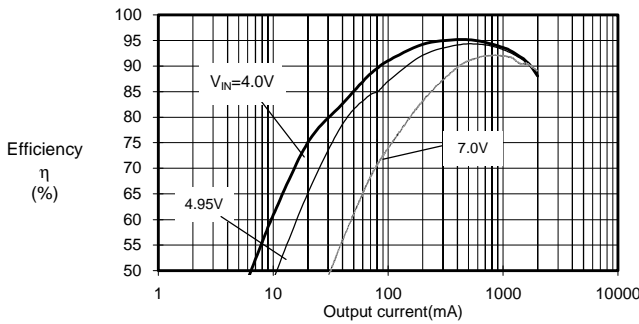

(4) S-8532B33AFT

Output current— Efficiency(Si3441DV/Si3442DV)

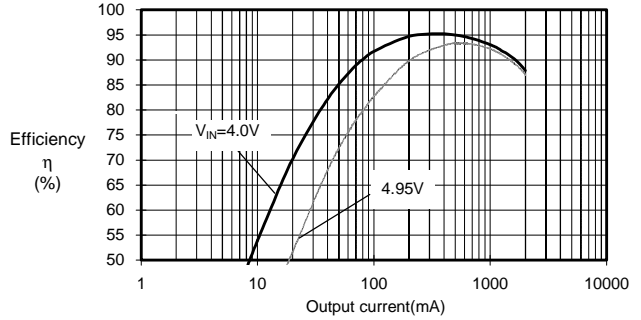

(5) S-8532B33AFT

Output current— Efficiency(CPH6302/CPH6402)

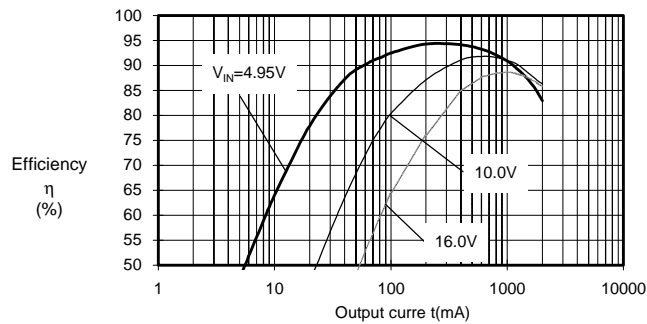

(6) S-8532B33AFT

Output current— Efficiency(Si3454DV/Si3455DV)

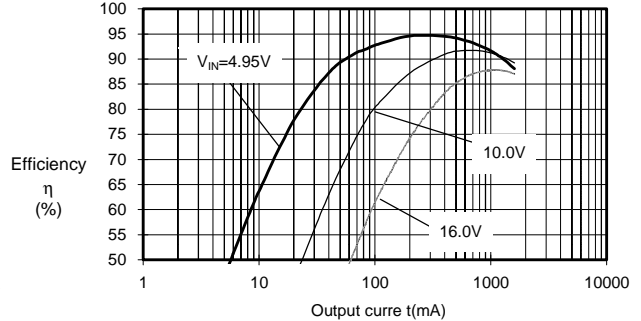

(7) S-8532B50AFT

Output current— Efficiency(CPH6302/CPH6402)

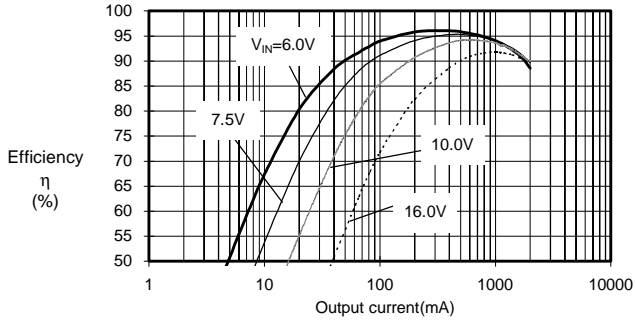

(8) S-8532B50AFT

Output current— Efficiency(Si3454DV/Si3455DV)

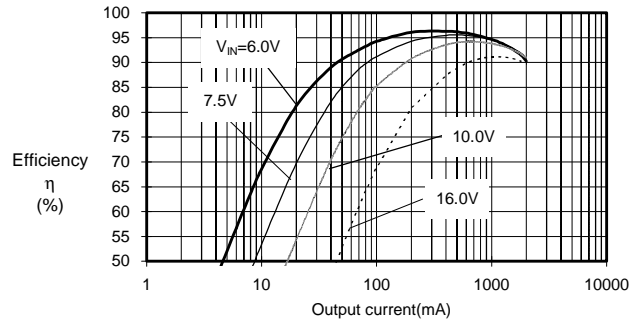

(9) S-8532B15AFT

Output current—Efficiency(CPH6303/CPH6403)

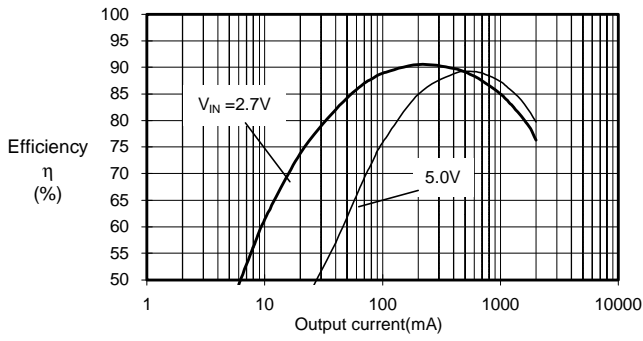

(10) S-8532B15AFT

Output current—Efficiency(Si3441DV/Si3442DV)

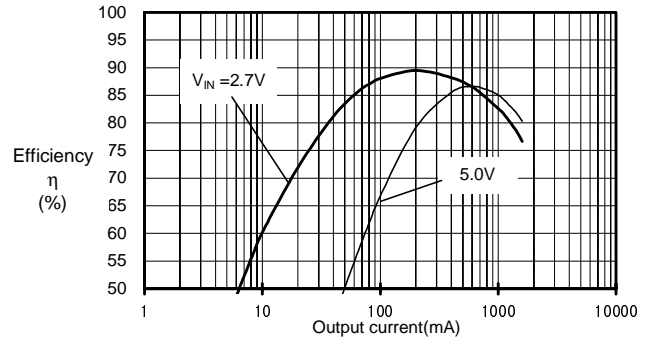

(11) S-8532B33AFT

Output current—Efficiency(CPH6303/CPH6403)

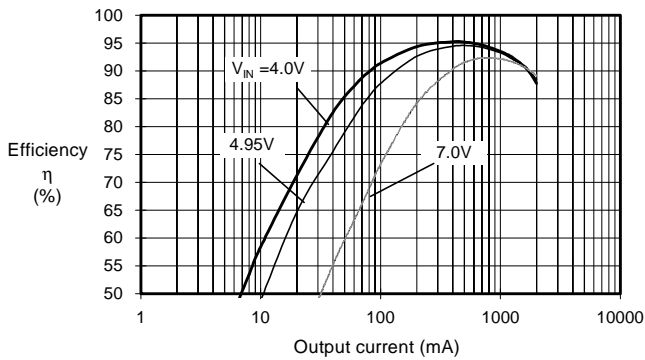

(12) S-8532B33AFT

Output current—Efficiency(Si3441DV/Si3442DV)

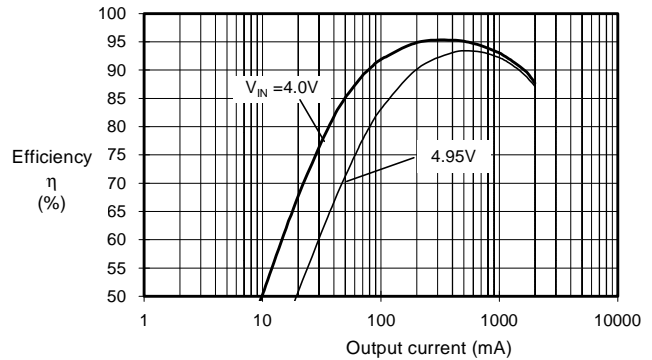

(13) S-8532B33AFT

Output current—Efficiency(CPH6302/CPH6402)

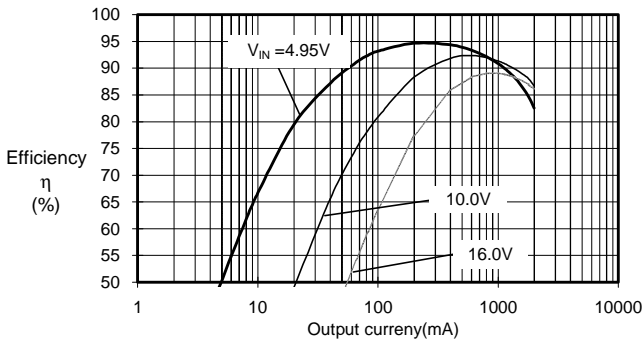

(14) S-8532B33AFT

Output current—Efficiency(Si3454DV/Si3455DV)

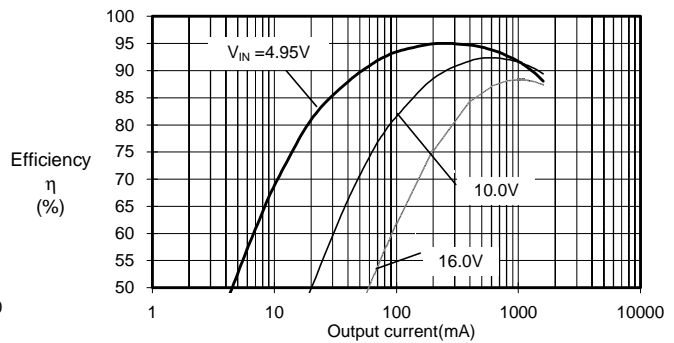

(15) S-8532B50AFT

Output current—Efficiency(CPH6302/CPH6402)

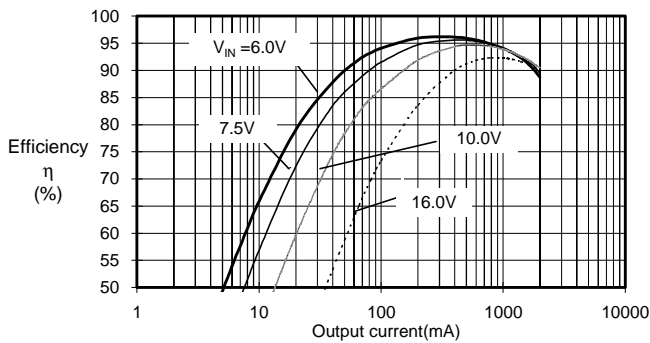

(16) S-8532B50AFT

Output current—Efficiency(Si3454DV/Si3455DV)

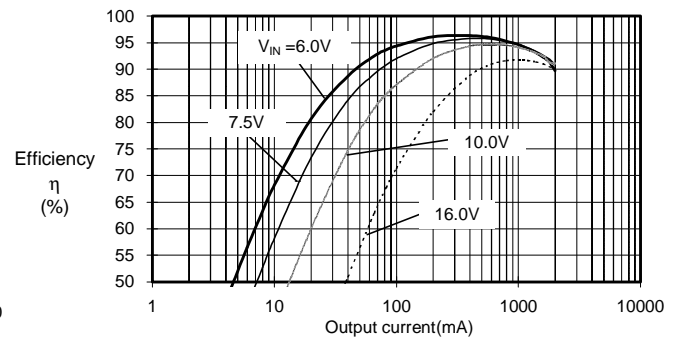

(17)S-8532B15AFT

Output current—Efficiency(CPH6303/CPH6403)

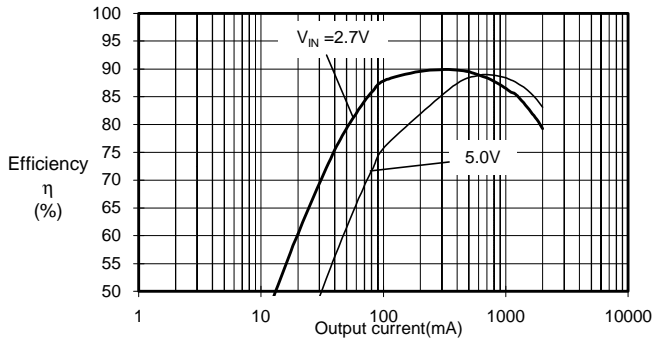

(18)S-8532B15AFT

Output current—Efficiency(Si3441DV/Si3442DV)

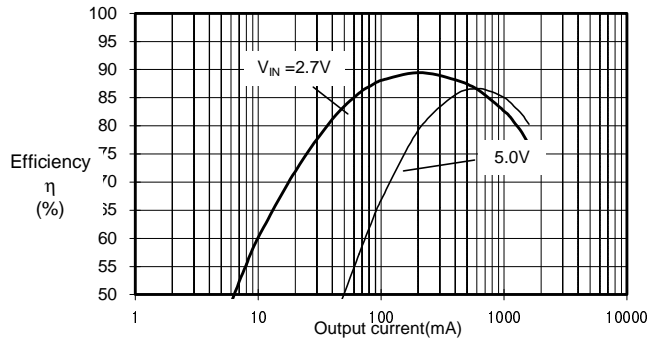

(19)S-8532B33AFT

Output current—Efficiency(CPH6303/CPH6403)

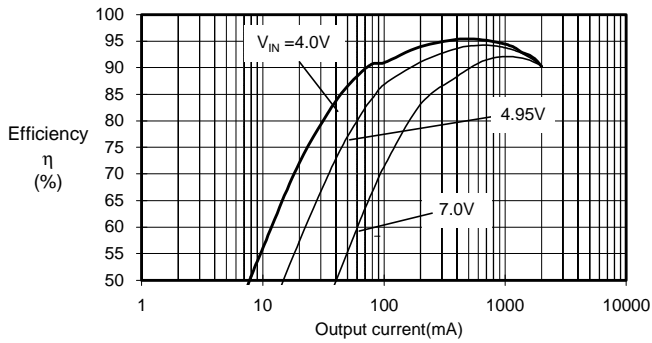

(20)S-8532B33AFT

Output current—Efficiency(Si3441DV/Si3442DV)

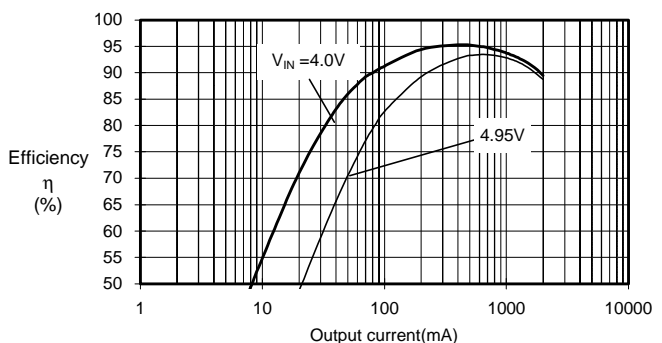

(21)S-8532B33AFT

Output current—Efficiency(CPH6302/CPH6402)

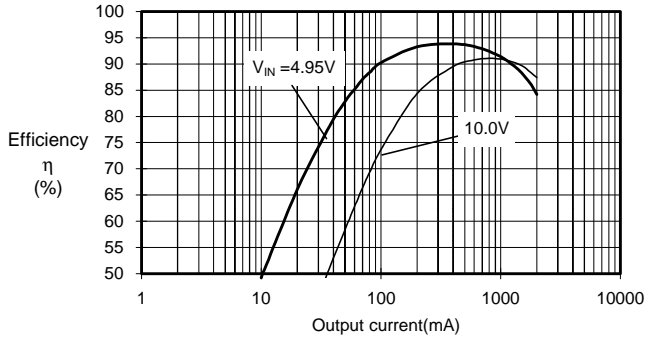

(22)S-8532B33AFT

Output current—Efficiency(Si3454DV/Si3455DV)

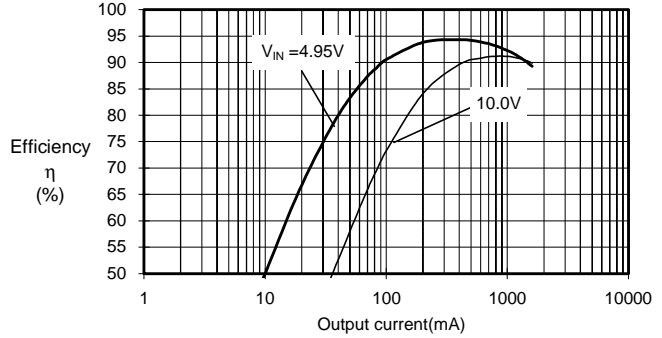

(23)S-8532B33AFT

Output current—Efficiency(CPH6302/CPH6402)

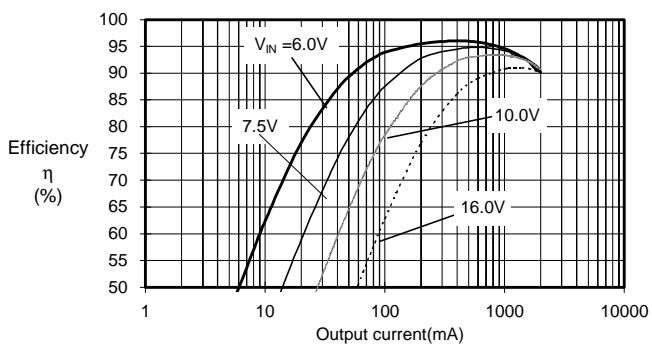

(24)S-8532B33AFT

Output current—Efficiency(Si3454DV/Si3455DV)

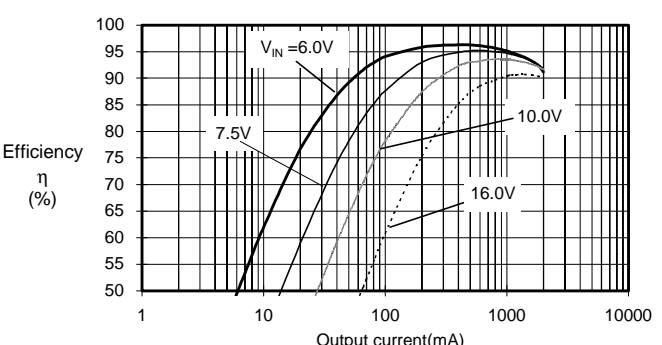

(25)S-8532B33AFT

Output current—Efficiency(CPH6303/CPH6403)

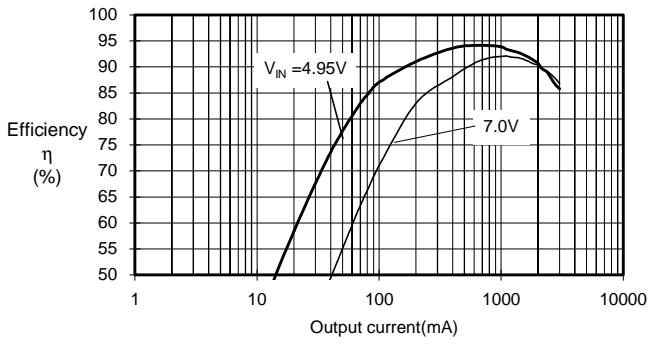

(26)S-8532B33AFT

Output current—Efficiency(CPH6302/CPH6402)

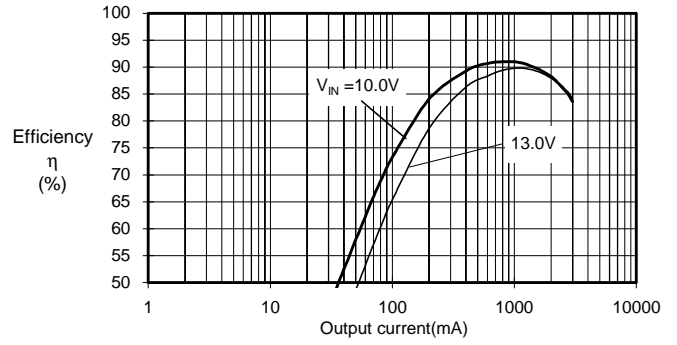

2.Ripple Voltage Characteristics

(27)S-8532B15AFT

Output current—Ripple voltage(CPH6303/CPH6403)

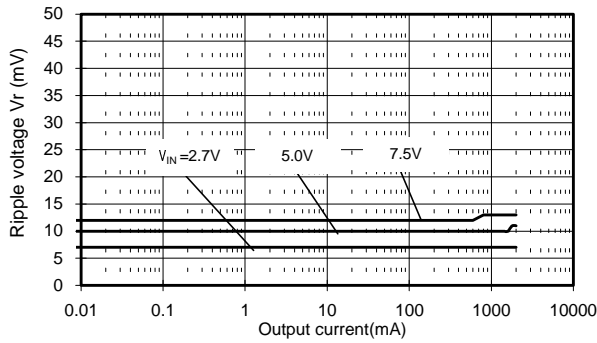

(28)S-8532B15AFT

Output current—Ripple voltage(Si3441DV/Si3442DV)

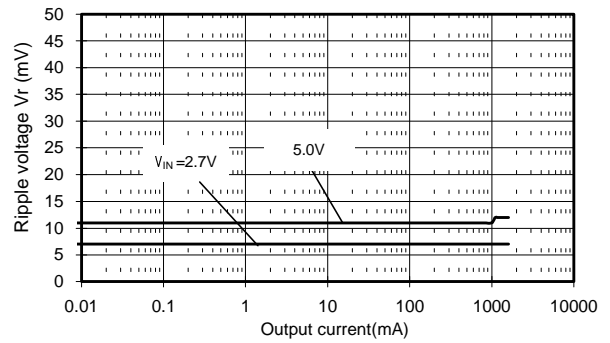

(29)S-8532B15AFT

Output current—Ripple voltage(CPH6303/CPH6403)

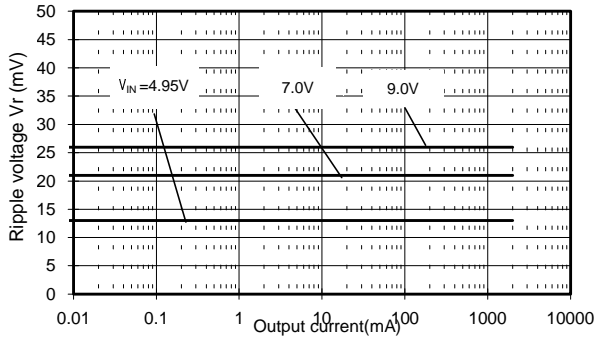

(30)S-8532B15AFT

Output current—Ripple voltage(Si3441DV/Si3442DV)

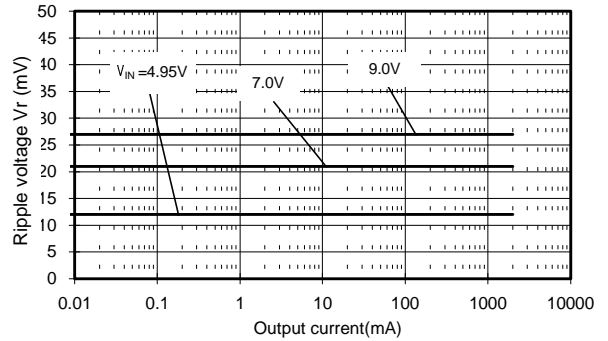

(31)S-8532B15AFT

Output current—Ripple voltage(CPH6302/CPH6402)

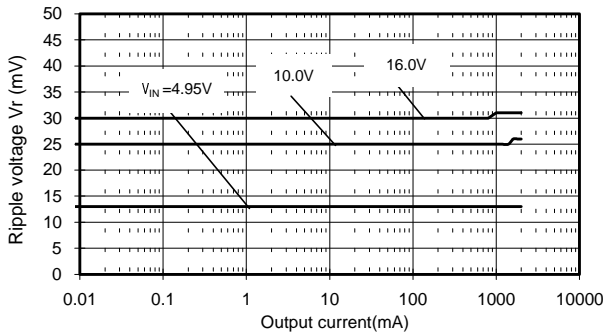

(32)S-8532B15AFT

Output current—Ripple voltage(Si3454DV/Si3455DV)

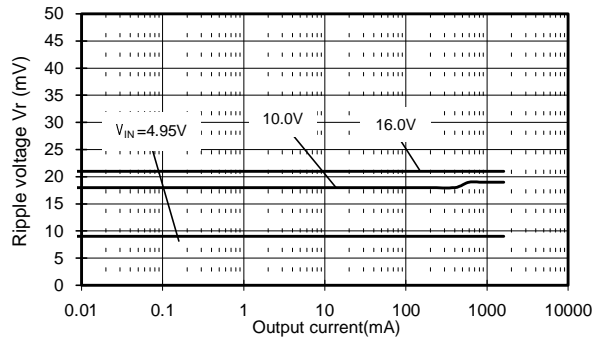

(33)S-8532B15AFT

Output current—Ripple voltage(CPH6302/CPH6402)

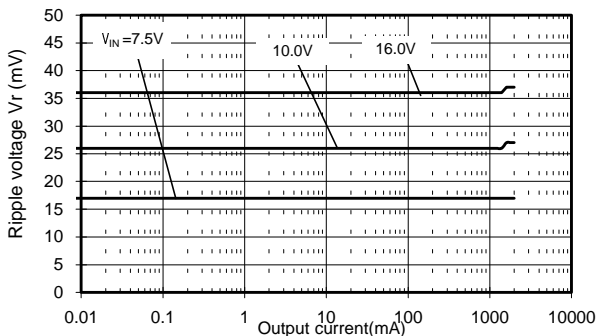

(34)S-8532B15AFT

Output current—Ripple voltage(Si3454DV/Si3455DV)

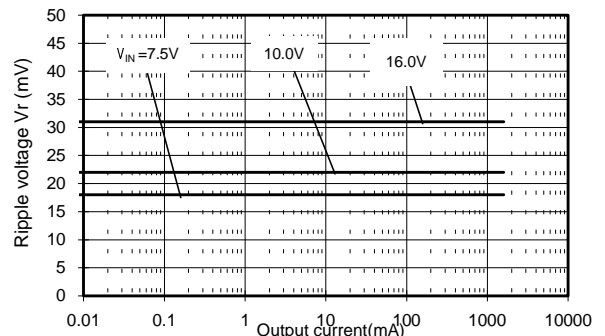

8-pin TSSOP

FT008-A 990531

Dimensions

Unit:mm

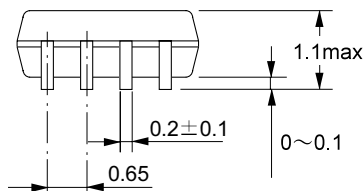
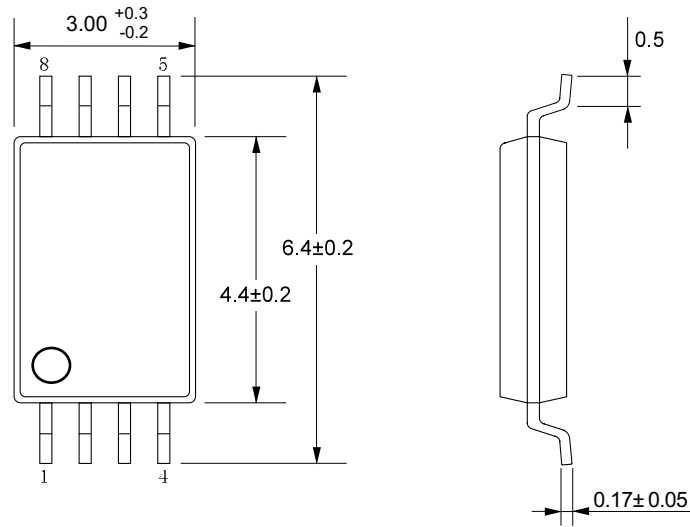

No. : FT008-A-P-SD-1.0

Taping Specifications

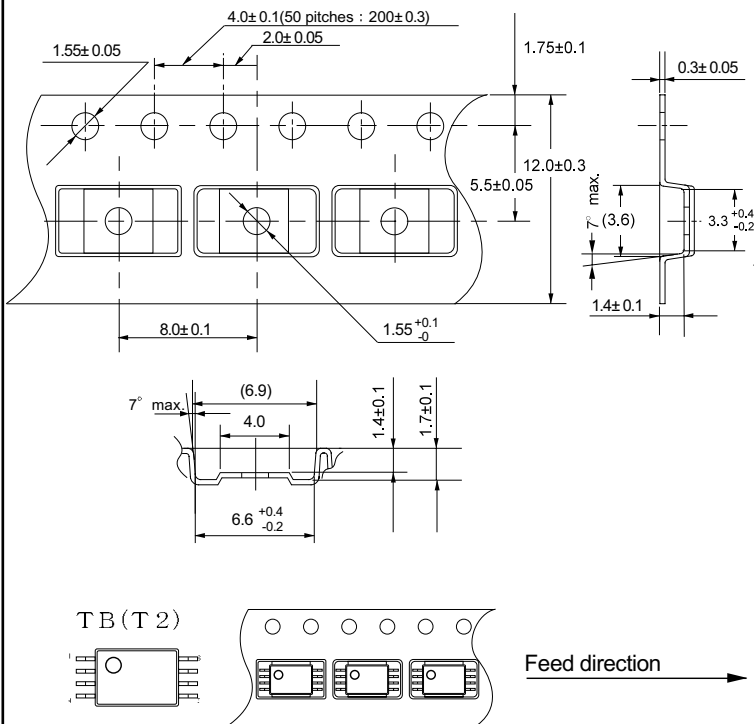

TB(T2)

Feed direction →

No. : FT008-A-C-SD-1.0

Reel Specifications

1 reel holds 3000 ICs.

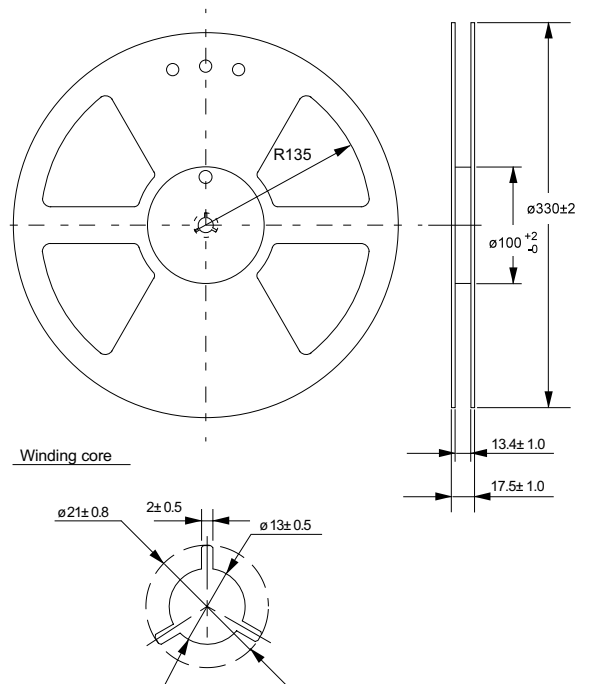

Winding core

No. : FT008-A-R-SD-1.0

● Dimensions

Unit : mm

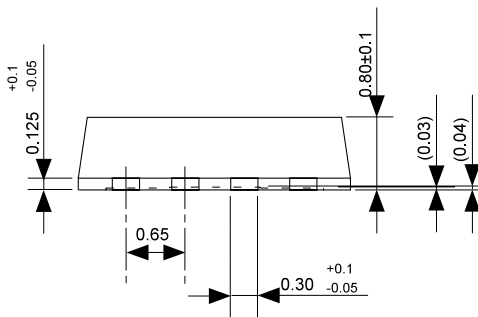
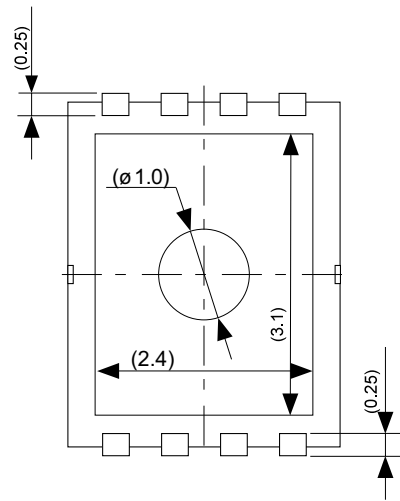
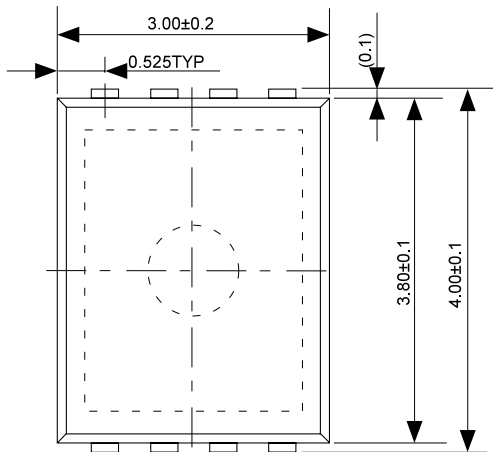

No. : PA008-B-P-SD-1.0

● Taping Specifications

● Reel Specifications

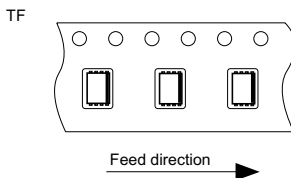
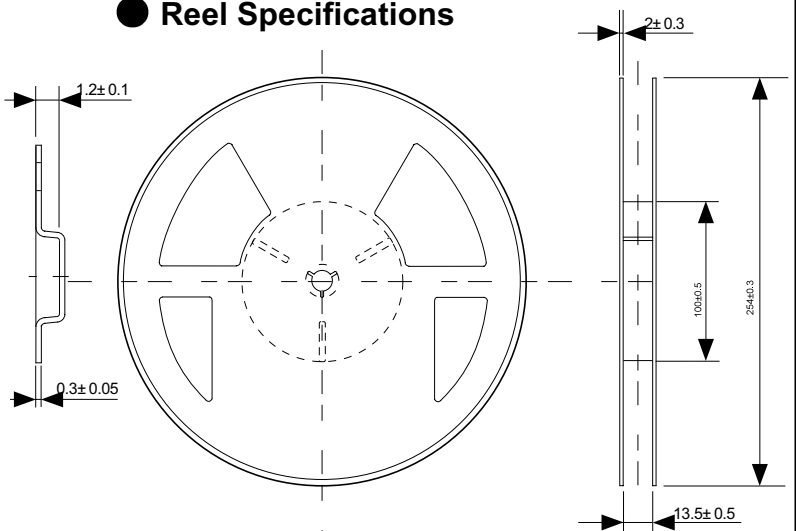
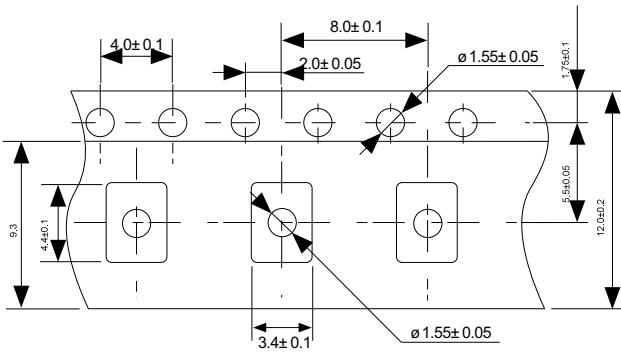

Winding core

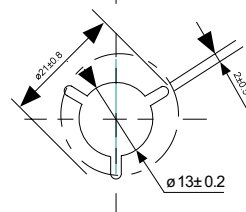

No. : PA008-B-C-SD-1.0

No. : PA008-B-R-SD-1.0

- The information described herein is subject to change without notice.
- Seiko Instruments Inc. is not responsible for any problems caused by circuits or diagrams described herein whose related industrial properties, patents, or other rights belong to third parties. The application circuit examples explain typical applications of the products, and do not guarantee the success of any specific mass-production design.
- When the products described herein are regulated products subject to the Wassenaar Arrangement or other agreements, they may not be exported without authorization from the appropriate governmental authority.
- Use of the information described herein for other purposes and/or reproduction or copying without the express permission of Seiko Instruments Inc. is strictly prohibited.
- The products described herein cannot be used as part of any device or equipment affecting the human body, such as exercise equipment, medical equipment, security systems, gas equipment, or any apparatus installed in airplanes and other vehicles, without prior written permission of Seiko Instruments Inc.
- Although Seiko Instruments Inc. exerts the greatest possible effort to ensure high quality and reliability, the failure or malfunction of semiconductor products may occur. The user of these products should therefore give thorough consideration to safety design, including redundancy, fire-prevention measures, and malfunction prevention, to prevent any accidents, fires, or community damage that may ensue.