

The S-8823A Series is a boost charge pump which enables operation with ultra-low power and ultra-low voltage. An original circuit system and SOI technology allow this product to boost the industry's lowest level^{*1} 0.35 V ultra-low input voltage as a boost charge pump, and achieve operation with an extremely weak power of 26 μ W. This makes the S-8823A Series most suitable for use in applications where low-voltage energy harvesting devices such as 1-cell to 2-cell solar cells and biofuels, etc. are boosted.

The boosted electric power is stored in an external capacitor, and the discharge operation is started to intermittently drive LED or other minute loads of several mW if the capacitor reaches the discharge start voltage (V_{CPOUT1}).

It also includes boost flying capacitors, which allows for formation of a circuit by adding a minimum of just one external capacitor, thus realizing miniaturization of devices.

*1. Based on available information as of October 2016

■ Features

- Ultra-low power and ultra-low voltage operation: Input power at startup ($P_{IN(START-UP)}$) = 26 μ W typ.
($V_{CPOUT1(S)} = 1.8$ V, $V_{IN} = 0.35$ V) ($T_a = +25^\circ\text{C}$)
- Minimum operation input voltage: 0.35 V ($V_{CPOUT1(S)} = 1.8$ V) ($T_a = +25^\circ\text{C}$)
0.39 V ($V_{CPOUT1(S)} = 1.8$ V to 2.4 V) ($T_a = -40^\circ\text{C}$ to $+85^\circ\text{C}$)
- Current consumption during operation: 74 μ A typ. ($V_{IN} = 0.35$ V)
- Discharge start voltage: $V_{CPOUT1(S)} = 1.8$ V to 2.4 V (Selectable in 0.2 V step)
- Power-off voltage: $V_{CPOUT1} + 0.1$ V (Fixed internally)
- External component: External capacitor (C_{CPOUT}) \times 1 unit^{*1}
- Operation temperature range: $T_a = -40^\circ\text{C}$ to $+85^\circ\text{C}$
- Lead-free (Sn 100%), halogen-free

*1. Adjust the output capacitance based on the load. The capacitance should be fully confirmed using an actually mounted model since it affects the startup time. Refer to "■ Characteristics (Typical Data)" for details.

■ Applications

- Biofuel, fuel cell, thermoelectric generator, solar cell and other energy harvesting
- Boosting from low-voltage power supply
- Intermittently power supplying to intermittent operation system
- Intermittently minute load driving

■ Packages

- SOT-23-5
(2.8 mm \times 2.9 mm \times t1.3 mm max.)
- SNT-8A
(2.46 mm \times 1.97 mm \times t0.5 mm max.)

■ Typical Application Circuit

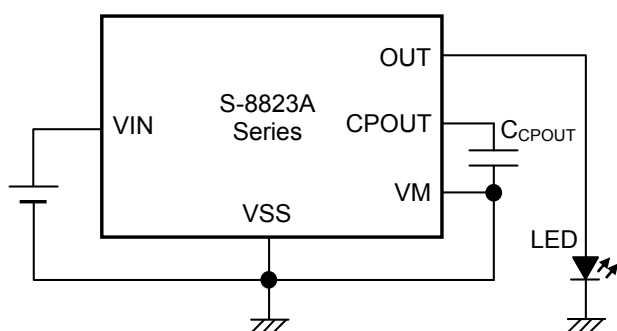

■ Basic Operation Waveform

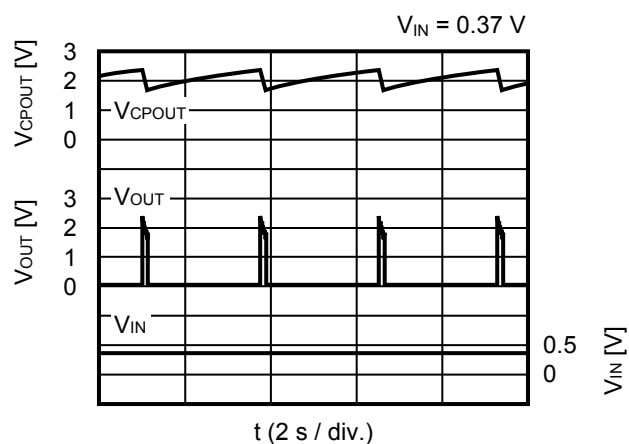

■ Product Name Structure

Users can select the discharge start voltage and the package type for the S-8823A Series. Refer to "1. Product name" regarding the contents of product name, "2. Packages" regarding the package drawings and "3. Product name list" regarding the product name.

1. Product name

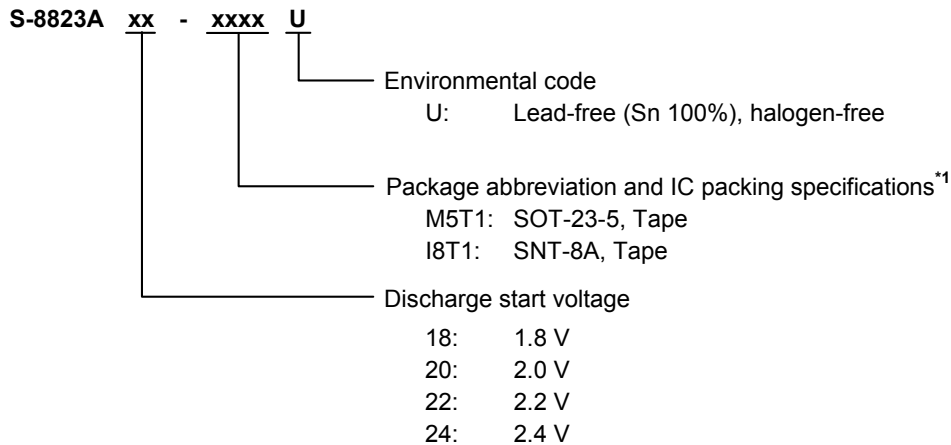

*1. Refer to the tape drawing.

2. Packages

Table 1 Package Drawing Codes

Package Name	Dimension	Tape	Reel	Land
SOT-23-5	MP005-A-P-SD	MP005-A-C-SD	MP005-A-R-SD	–
SNT-8A	PH008-A-P-SD	PH008-A-C-SD	PH008-A-R-SD	PH008-A-L-SD

3. Product name list

Table 2

Set Discharge Start Voltage ($V_{CPOUT1(S)}$)	Set Power-off Voltage ($V_{OFF(S)}$)	SOT-23-5	SNT-8A
1.8 V	1.9 V	S-8823A18-M5T1U	S-8823A18-I8T1U
2.0 V	2.1 V	S-8823A20-M5T1U	S-8823A20-I8T1U
2.2 V	2.3 V	S-8823A22-M5T1U	S-8823A22-I8T1U
2.4 V	2.5 V	S-8823A24-M5T1U	S-8823A24-I8T1U

Remark Please contact our sales office for products with set discharge start voltage other than the above.

■ Pin Configurations

1. SOT-23-5

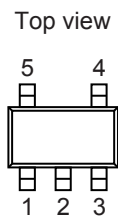

Figure 1

Table 3

Pin No.	Symbol	Description
1	OUT	Output pin
2	VSS	GND pin
3	VM	Power-on / power-off setting pin "L": Power-on (Normal operation) "H": Power-off (Standby)
4	VIN	Power supply input pin
5	CPOUT	External capacitor connection pin

2. SNT-8A

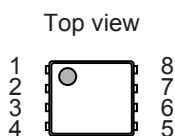

Figure 2

Table 4

Pin No.	Symbol	Description
1	NC ^{*1}	No connection
2	VIN	Power supply input pin
3	VM	Power-on / power-off setting pin "L": Power-on (Normal operation) "H": Power-off (Standby)
4	NC ^{*1}	No connection
5	OUT	Output pin
6	VSS	GND pin
7	CPOUT	External capacitor connection pin
8	NC ^{*1}	No connection

*1. The NC pin is electrically open.
 The NC pin can be connected to the VIN pin or the VSS pin.

■ **Absolute Maximum Ratings**

Table 5

(Ta = +25°C unless otherwise specified)

Item	Symbol	Absolute Maximum Rating	Unit
VIN pin voltage	V _{IN}	V _{SS} - 0.3 to V _{SS} + 3.3	V
CPOUT pin voltage	V _{CPOUT}	V _{SS} - 0.3 to V _{SS} + 3.3	V
OUT pin voltage	V _{OUT}	V _{SS} - 0.3 to V _{SS} + 3.3	V
VM pin voltage	V _{VM}	V _{SS} - 0.3 to V _{SS} + 3.3	V
Operation ambient temperature	T _{opr}	-40 to +85	°C
Storage temperature	T _{stg}	-40 to +125	°C

Caution The absolute maximum ratings are rated values exceeding which the product could suffer physical damage. These values must therefore not be exceeded under any conditions.

■ **Thermal Resistance Value**

Table 6

Item	Symbol	Condition	Min.	Typ.	Max.	Unit	
Junction-to-ambient thermal resistance*1	θ _{JA}	SOT-23-5	Board A	-	192	-	°C/W
			Board B	-	160	-	°C/W
			Board C	-	-	-	°C/W
			Board D	-	-	-	°C/W
			Board E	-	-	-	°C/W
		SNT-8A	Board A	-	211	-	°C/W
			Board B	-	173	-	°C/W
			Board C	-	-	-	°C/W
			Board D	-	-	-	°C/W
			Board E	-	-	-	°C/W

*1. Test environment: compliance with JEDEC STANDARD JESD51-2A

Remark Refer to "■ Power Dissipation" and "Test Board" for details.

■ Electrical Characteristics

Table 7

(Ta = +25°C unless otherwise specified)

Item	Symbol	Condition	Min.	Typ.	Max.	Unit
Discharge start voltage ^{*1}	V _{CPOUT1}	V _{IN} = 0.35 V	V _{CPOUT1(S)} - 0.1	V _{CPOUT1(S)}	V _{CPOUT1(S)} + 0.1	V
Discharge start voltage temperature coefficient	$\frac{\Delta V_{CPOUT1}}{\Delta Ta \bullet V_{CPOUT1}}$	Ta = -40°C to +85°C	-	±150	-	ppm/°C
Discharge stop voltage ^{*2}	V _{CPOUT2}	V _{CPOUT1(S)} = 1.8 V	V _{CPOUT1} - 0.60	-	V _{CPOUT1} - 0.33	V
		V _{CPOUT1(S)} = 2.0 V	V _{CPOUT1} - 0.67	-	V _{CPOUT1} - 0.33	V
		V _{CPOUT1(S)} = 2.2 V	V _{CPOUT1} - 0.74	-	V _{CPOUT1} - 0.33	V
		V _{CPOUT1(S)} = 2.4 V	V _{CPOUT1} - 0.80	-	V _{CPOUT1} - 0.33	V
Operation input voltage range 1 ^{*3}	V _{IN1}	V _{CPOUT1(S)} = 1.8 V	0.35	-	3.0	V
		V _{CPOUT1(S)} = 2.0 V	0.36	-	3.0	V
		V _{CPOUT1(S)} = 2.2 V, 2.4 V	0.37	-	3.0	V
Operation input voltage range 2 ^{*3}	V _{IN2}	V _{CPOUT1(S)} = 1.8 V, 2.0 V, Ta = -30°C to +60°C	0.37	-	3.0	V
		V _{CPOUT1(S)} = 1.8 V to 2.4 V, Ta = -40°C to +85°C	0.39	-	3.0	V
Discharge start delay time ^{*4}	t _{OUT}	V _{CPOUT1(S)} = 1.8 V, V _{IN} = 0.35 V, C _{CPOUT} = 10 μF	-	4.6	-	s
		V _{CPOUT1(S)} = 2.4 V, V _{IN} = 0.37 V, C _{CPOUT} = 10 μF	-	5.8	-	s
Discharge control switch resistance	R _{M1}	V _{CPOUT} = 1.8 V to 2.4 V, I _{OUT} = 3 mA	-	30	100	Ω
Input power at start-up	P _{IN(START-UP)}	V _{IN} = 0.35 V, V _{CPOUT} = 0 V	-	26	-	μW
Current consumption during operation	I _{SS}	V _{IN} = 0.35 V, V _{CPOUT} = 0 V	-	0.074	0.35	mA
		V _{IN} = 0.6 V, V _{CPOUT} = 0 V	-	0.38	1.1	mA
		V _{IN} = 1.0 V, V _{CPOUT} = 0 V	-	1.1	2.3	mA
Current consumption during power-off	I _{SSS}	V _{IN} = 0.35 V, V _{CPOUT} = 0 V, V _{VM} = 3.0 V	-	0.1	0.6	μA
		V _{IN} = 1.0 V, V _{CPOUT} = 0 V, V _{VM} = 3.0 V	-	0.1	0.7	μA
		V _{IN} = 2.0 V, V _{CPOUT} = 0 V, V _{VM} = 3.0 V	-	0.1	0.8	μA
Power-off voltage ^{*5}	V _{OFF}	V _{IN} = 0.35 V, V _{CPOUT} = 0 V	V _{OFF(S)} - 0.1	V _{OFF(S)}	V _{OFF(S)} + 0.1	V
Power-off voltage temperature coefficient	$\frac{\Delta V_{OFF}}{\Delta Ta \bullet V_{OFF}}$	Ta = -40°C to +85°C	-	±150	-	ppm/°C
Discharge control switch leakage current ^{*6}	I _{LEAK}	V _{IN} = V _{CPOUT} = 0 V, V _{OUT} = V _{VM} = 3.0 V	-	-	0.1	μA
VM pin input current	I _{VM}	V _{VM} = 3.0 V	-	0.7	1.8	μA

- *1. V_{CPOUT1}: Actual discharge start voltage
 V_{CPOUT1(S)}: Set discharge start voltage
- *2. Voltage at which discharge to the OUT pin stops
- *3. Input voltage required to start discharge to the OUT pin from the external capacitor
- *4. Delay time from when power is input to the VIN pin until the electric charge of the external capacitor is discharged to the OUT pin
- *5. V_{OFF}: Actual power-off voltage (VM pin voltage value at which power-off actually occurs)
 V_{OFF(S)}: Set power-off voltage (Set VM pin voltage at which power-off occurs)
 V_{OFF(S)} is automatically set to V_{CPOUT1(S)} + 0.1 V.
- *6. Current that flows into the IC from the OUT pin due to the off-leak current of the discharge control switch

Caution Set the discharge start voltage based on thorough evaluation including the temperature characteristics under the actual usage conditions.

■ Operation

1. Basic operation

Figure 3 shows an internal block diagram to describe the basic operation.

- (1) In the S-8823A Series, when a voltage is input to the VIN pin, the oscillation circuit starts operation, and the CLK signal is output.
- (2) The charge pump circuit is driven by the CLK signal to boost the voltage input to the VIN pin.
- (3) The voltage boosted in the charge pump circuit is output from the CPOUT pin and is gradually charged to the external capacitor (C_{CPOUT}) connected to the CPOUT pin. Consequently, the voltage of the CPOUT pin gradually rises.
- (4) When the CPOUT pin voltage (V_{CPOUT}) reaches or exceeds the discharge start voltage (V_{CPOUT1}), the output signal of the comparator (COMP1) changes from "H" to "L". As a result, the discharge control switch (M1), which was off, turns on.
- (5) When M1 turns on, the boosted voltage charged to C_{CPOUT} is discharged from the OUT pin.
- (6) When V_{CPOUT} decreases to the level of the discharge stop voltage (V_{CPOUT2}) as the result of the discharge, M1 turns off, and the discharge is stopped.
- (7) When the VM pin voltage (V_{VM}) reaches or exceeds the power-off voltage (V_{OFF}), the output signal (EN-) of the comparator (COMP2) changes from "L" to "H". As a result, the oscillation circuit stops operation and the power-off status is entered.
- (8) When V_{VM} does not reach or exceed V_{OFF} , the voltage input to the VIN pin is boosted in the charge pump circuit and is recharged to C_{CPOUT} (Return to the operation specified in (3)).

Caution When stopping the discharge to the OUT pin and recharging the external capacitor (C_{CPOUT}), C_{CPOUT} needs to be discharged until CPOUT pin voltage (V_{CPOUT}) decreases to discharge stop voltage (V_{CPOUT2}) or lower. In this case, set the condition as follows:

Condition: OUT pin voltage (V_{OUT}) < V_{CPOUT2}

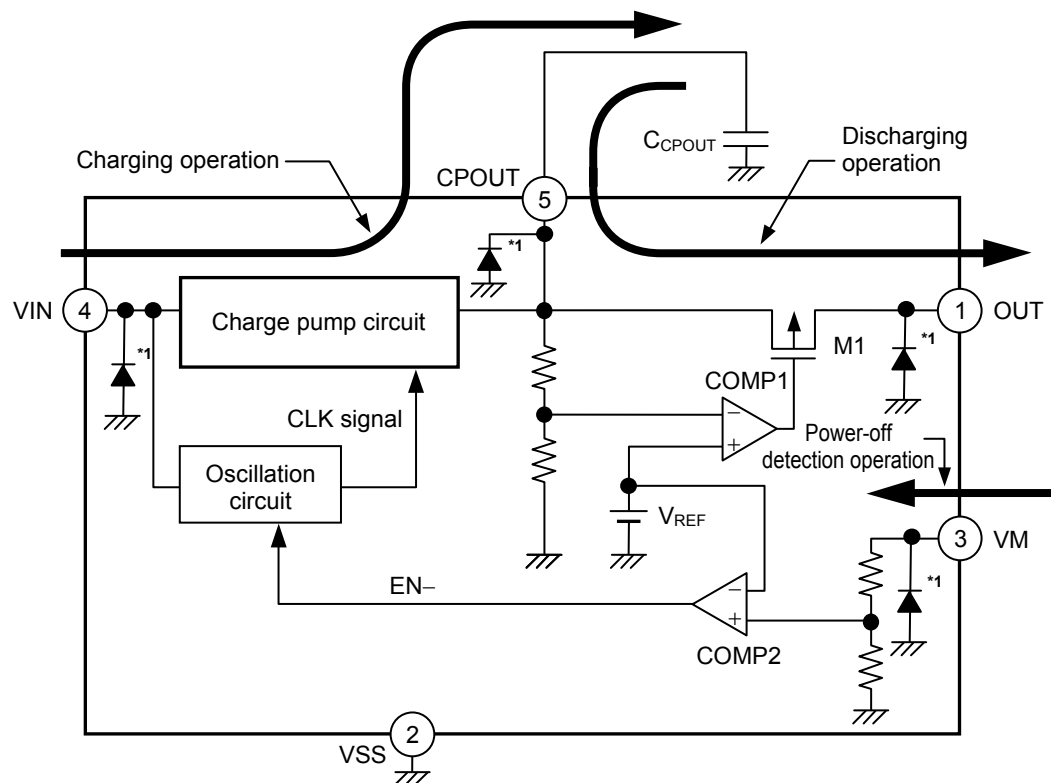

*1. Parasitic diode

Figure 3

2. Power-on / power-off setting pin (VM pin)

When the power-off voltage (V_{OFF}) or higher is applied to the VM pin voltage (V_{VM}), the power-off status is entered. When this happens, the internal oscillation circuit stops its operation, so that the charge pump circuit operation stops, and greatly reduces the current consumption. **Figure 4** shows the configuration of the VM pin.

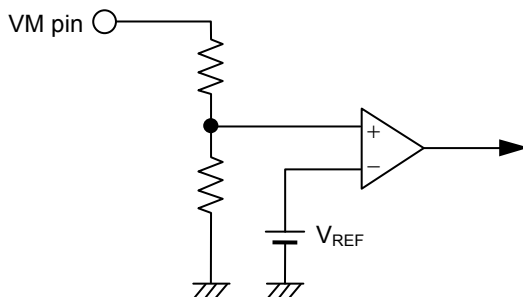

Figure 4 VM Pin Configuration

Table 8

VM Pin	Internal Circuit
$V_{VM} < V_{OFF}$	Operate
$V_{VM} \geq V_{OFF}$	Stop

Set V_{VM} during power-off as follows.

$$3.0 \text{ V} \geq V_{VM} \geq V_{IN} + 1.0 \text{ V}$$

$$3.0 \text{ V} \geq V_{VM} \geq V_{OUT}$$

When $V_{VM} < V_{IN} + 1.0 \text{ V}$ occurs, the current consumption during power-off increases.

When $V_{VM} < V_{OUT}$ occurs, the discharge control switch leak current increases.

- Caution**
1. When not using the VM pin in actual use, be sure to connect it to the VSS pin. If the VM pin is left open, it may cause malfunctions.
 2. Note that the operation to recharge the external capacitor (C_{CPOUT}) does not restart when CPOUT pin voltage (V_{CPOUT}) exceeds the discharge stop voltage (V_{CPOUT2}) even if the power-off status is released. This operation restarts if V_{CPOUT} decreases to V_{CPOUT2} or lower by discharge of C_{CPOUT} .
 3. Do not connect a high resistance to the VM pin. Note that the VM pin input current (I_{VM}) max. may not flow if a high resistance is connected.

■ **Typical Application**

Figure 5 shows the circuit diagram of the typical application in the S-8823A Series where the electric power is supplied intermittently to the resistance (R_{OUT}) connected to the OUT pin, and **Figure 6** shows the timing chart.

The voltage input to the VIN pin is boosted and is stored in the external capacitor (C_{CPOUT}) connected to the CPOUT pin. When the CPOUT pin voltage (V_{CPOUT}) reaches discharge start voltage (V_{CPOUT1}), the discharge control switch turns on, supplying R_{OUT} with the power stored in C_{CPOUT} . C_{CPOUT} is discharged by R_{OUT} , and when V_{CPOUT} becomes discharge stop voltage (V_{CPOUT2}) or lower, the discharge control switch turns off and stops supplying power to the OUT pin, and performs the operation to recharge C_{CPOUT} . In this case, when $V_{CPOUT} > 0$ V, the current consumption for operation is reduced more than when $V_{CPOUT} = 0$ V, making it easier to continue the operation.

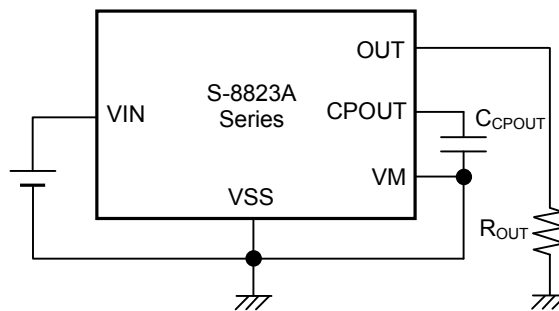

Figure 5

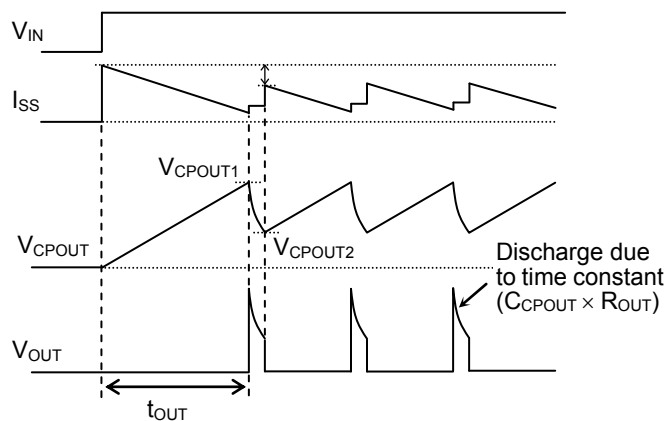

Figure 6

■ Selection of External Capacitor (C_{CPOUT})

The S-8823A Series boosts the low input voltage and stores it in an external capacitor (C_{CPOUT}), and intermittently drives minute load connected to the OUT pin by using the stored power (Refer to **Figure 7**).

Moreover, the S-8823A Series can also intermittently supply power to a capacitor with a large capacitance via a Schottky-barrier diode (SBD) connected to the OUT pin (Refer to **Figure 10**). In this case, set the capacitance of C_{CPOUT} smaller when setting the ripple voltage of the V_{VOUT} lower.

Select the discharge start voltage (V_{CPOUT1}) and the capacitance of C_{CPOUT} according to the load connected.

- Caution**
1. The S-8823A Series can supply more energy to the OUT pin as the discharge start voltage (V_{CPOUT1}) is higher and the capacitance of the external capacitor (C_{CPOUT}) is larger. However, note that the time from when the power is input until the the discharge operation starts becomes longer in this case.
 2. Note that if the discharge start voltage (V_{CPOUT1}) > 2.0 V, the minimum operation input voltage (V_{IN} min.) (the minimum input voltage value required for power to be output from the OUT pin of the S-8823A Series) rises from 0.37 V to 0.39 V (Refer to Table 9).
 3. When the capacitance of the external capacitor (C_{CPOUT}) is lower, the discharge operation may start if the ripple voltage of the CPOUT pin reaches the discharge start voltage (V_{CPOUT1}). The influence of the ripple voltage can be reduced by setting C_{CPOUT} larger in this case.
 4. Do not connect a load other than a capacitance to the CPOUT pin. Note that the discharge operation may not be performed if a resistance, etc. is connected.

Table 9

Discharge Start Voltage (V_{CPOUT1})	Operation Input Voltage (V_{IN})	Operation Temperature Range
1.8 V, 2.0 V	0.37 V min.	$T_a = -30^{\circ}\text{C}$ to $+60^{\circ}\text{C}$
1.8 V to 2.4 V	0.39 V min.	$T_a = -40^{\circ}\text{C}$ to $+85^{\circ}\text{C}$

Caution The above connection diagram and constant will not guarantee successful operation. Perform thorough evaluation using the actual application to set the constant.

■ **Standard Circuits**

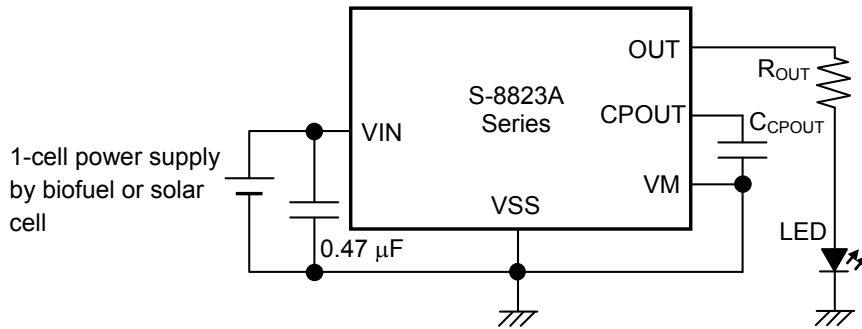

Figure 7 Intermittently LED Driving Circuit

$V_{IN} = 0.37\text{ V}$, $V_{CPOUT1(S)} = 2.4\text{ V}$, $C_{CPOUT} = 10\ \mu\text{F}$, $T_a = +25^\circ\text{C}$

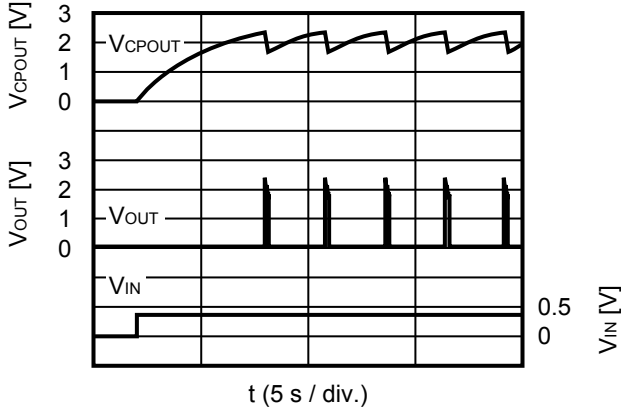

Figure 8 Startup Waveform for Intermittently LED Driving

$V_{IN} = 0.37\text{ V}$, $V_{CPOUT1(S)} = 2.4\text{ V}$, $C_{CPOUT} = 10\ \mu\text{F}$, $T_a = +25^\circ\text{C}$

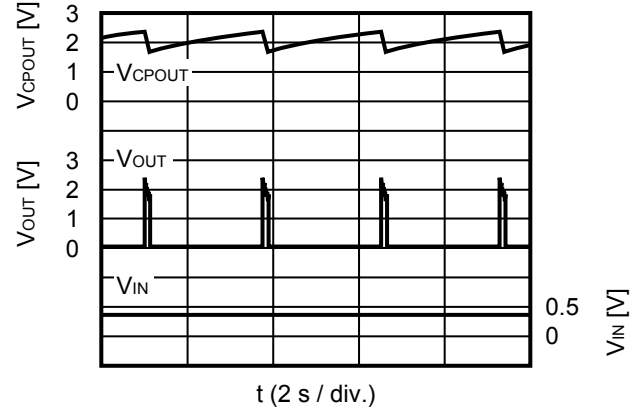

Figure 9 Steady-state Operation Waveform for Intermittently LED Driving

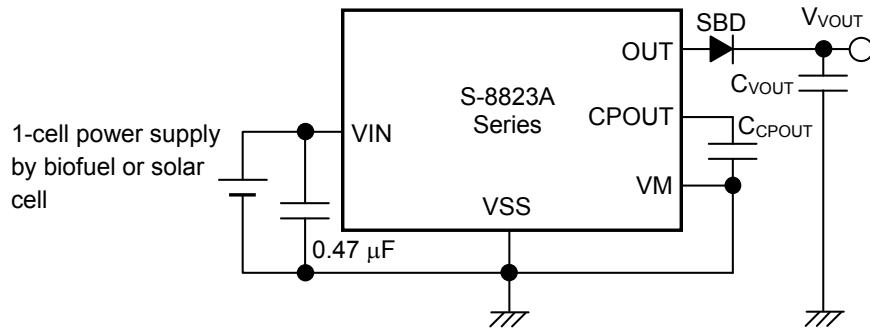
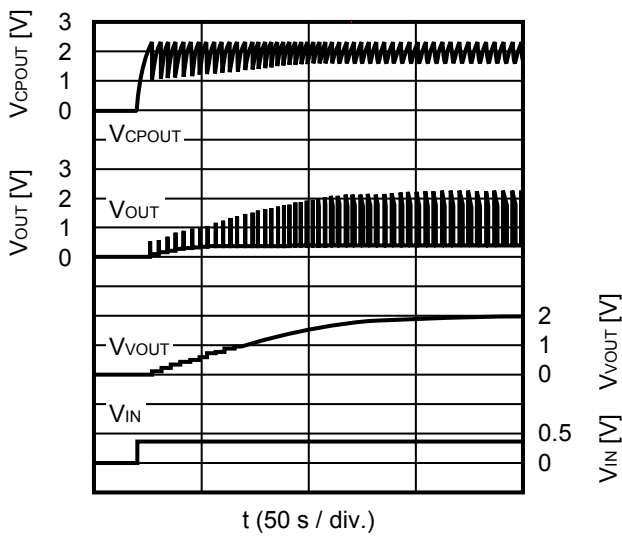

Figure 10 Circuit of Intermittently Power Supplying to Capacitor

$V_{IN} = 0.37\text{ V}$, $V_{CPOUT1(S)} = 2.4\text{ V}$, $C_{CPOUT} = 10\ \mu\text{F}$, $C_{VOUT} = 100\ \mu\text{F}$, $T_a = +25^\circ\text{C}$



$V_{IN} = 0.37\text{ V}$, $V_{CPOUT1(S)} = 2.4\text{ V}$, $C_{CPOUT} = 10\ \mu\text{F}$, $C_{VOUT} = 100\ \mu\text{F}$, $T_a = +25^\circ\text{C}$

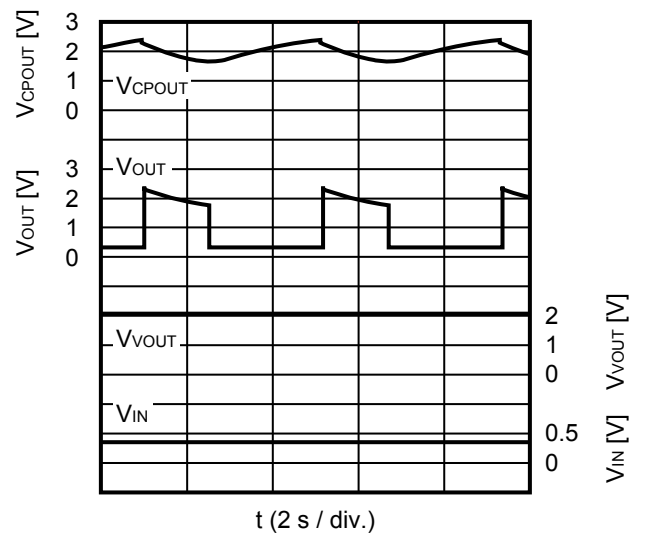

Figure 11 Startup Waveform for Intermittently Power Supplying to Capacitor

Figure 12 Steady-state Operation Waveform for Intermittently Power Supplying to Capacitor

Caution The above connection diagram and constant will not guarantee successful operation. Perform thorough evaluation using the actual application to set the constant.

■ Precautions

- If the consumption current during power-off (I_{SSS}) needs to be kept at 0.1 μ A or lower, set the VM pin voltage (V_{VM}) so that conditions (1) and (2) below are satisfied.
 - (1) $V_{VM} \geq$ Power-off voltage (V_{OFF})
 - (2) Operation input voltage (V_{IN}) + 1.0 V $\leq V_{VM} \leq$ 3.0 V
- When selecting products, fully check them using an actually mounted model. Refer to "■ Selection of External Capacitor (C_{CPOUT})" for details.
- The discharge start delay time (t_{OUT}) will be longer according to conditions (1), (2), and (3) below. Also note it will be further longer when these conditions are combined.
 - (1) The operation input voltage (V_{IN}) is low.
 - (2) The discharge start voltage (V_{CPOUT1}) is high.
 - (3) The capacitance of external capacitor (C_{CPOUT}) is large.
- When stopping the discharge to the OUT pin and recharging the external capacitor (C_{CPOUT}), C_{CPOUT} needs to be discharged until CPOUT pin voltage (V_{CPOUT}) decreases to the discharge stop voltage (V_{CPOUT2}) or lower. In this case, set the condition as follows:

Condition: OUT pin voltage (V_{OUT}) < V_{CPOUT2}
- When not using the VM pin in actual use, be sure to connect it to the VSS pin. If the VM pin is left open, it may cause malfunctions.
- Note that the operation to recharge the external capacitor (C_{CPOUT}) does not restart when CPOUT pin voltage (V_{CPOUT}) exceeds the discharge stop voltage (V_{CPOUT2}) even if the power-off status is released. This operation restarts if V_{CPOUT} decreases to V_{CPOUT2} or lower by discharge of C_{CPOUT} .
- Do not connect a high resistance to the VM pin. Note that the VM pin input current (I_{VM}) max. may not flow if a high resistance is connected.
- The S-8823A Series can supply more energy to the OUT pin as the discharge start voltage (V_{CPOUT1}) is higher and the capacitance of the external capacitor (C_{CPOUT}) is larger. However, note that the time from when the power is input until the discharge operation starts becomes longer in this case.
- Note that if the discharge start voltage (V_{CPOUT1}) > 2.0 V, the minimum operation input voltage (V_{IN} min.) (the minimum input voltage value required for power to be output from the OUT pin of the S-8823A Series) rises from 0.37 V to 0.39 V (Refer to **Table 9**).
- When the capacitance of the external capacitor (C_{CPOUT}) is lower, the discharge operation may start if the ripple voltage of the CPOUT pin reaches the discharge start voltage (V_{CPOUT1}). The influence of the ripple voltage can be reduced by setting C_{CPOUT} larger in this case.
- Do not connect a load other than a capacitance to the CPOUT pin. Note that the discharge operation may not be performed if a resistance, etc. is connected.
- When the operation input voltage (V_{IN}) is higher or the OUT pin current is extremely low, the CPOUT pin voltage (V_{CPOUT}) equal to or more than the discharge start voltage (V_{CPOUT1}) may be output.
- When designing for mass production using the application circuit described herein, the product deviation and temperature characteristics should be taken into consideration. ABLIC Inc. shall not bear any responsibility for the products on the circuits described herein.
- Do not apply an electrostatic discharge to this IC that exceeds the performance ratings of the built-in electrostatic protection circuit.
- ABLIC Inc. claims no responsibility for any disputes arising out of or in connection with any infringement by products including this IC of patents owned by a third party.

■ Characteristics (Typical Data)

1. Example of major voltage characteristics (Ta = +25°C)

1.1 Discharge start voltage (V_{CP_{OUT1}}), discharge stop voltage (V_{CP_{OUT2}}) vs. Input voltage (V_{IN})

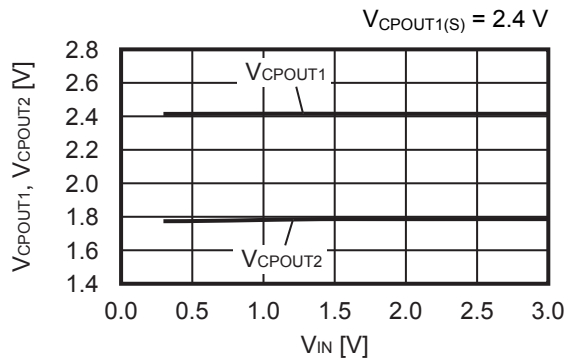
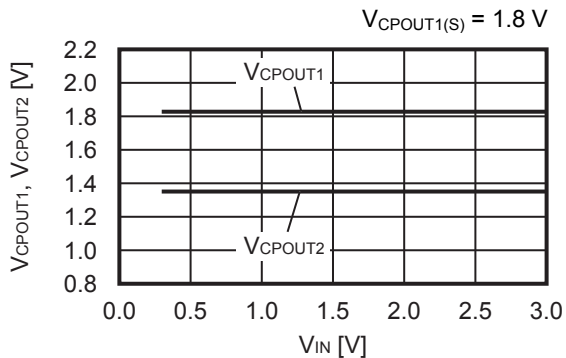

1.2 Discharge start delay time (t_{OUT}) vs. Input voltage (V_{IN})

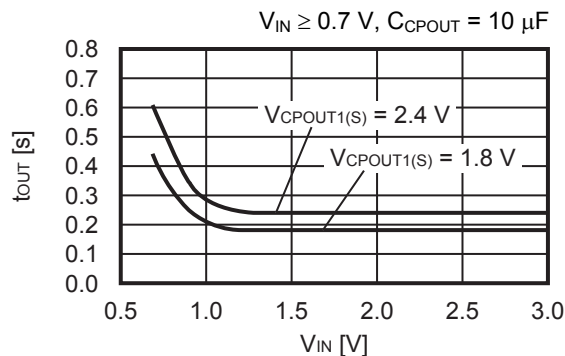
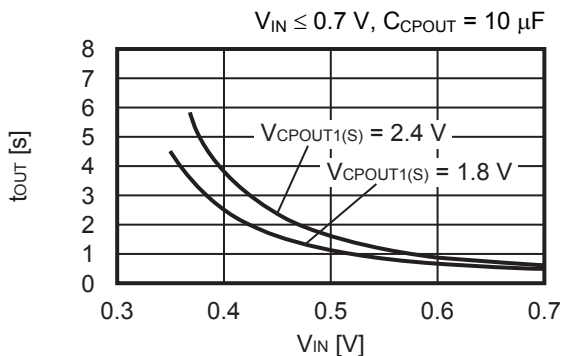

1.3 Discharge start delay time (t_{OUT}) vs. Capacitance of external capacitor (C_{CP_{OUT}})

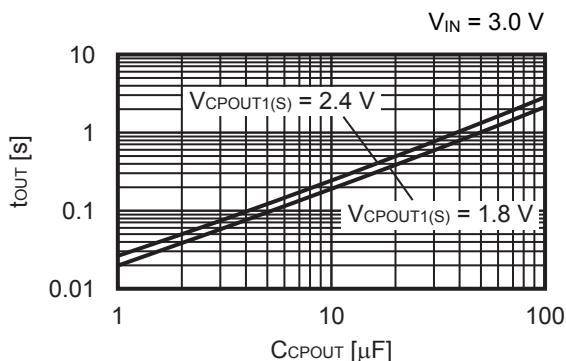
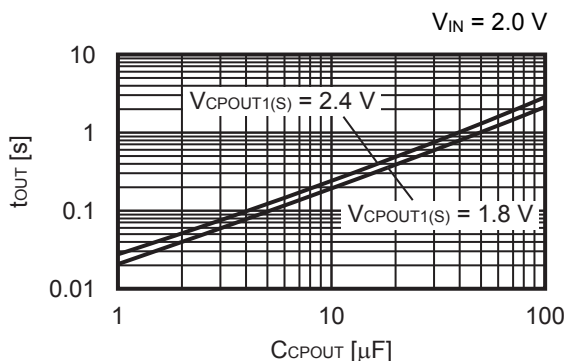
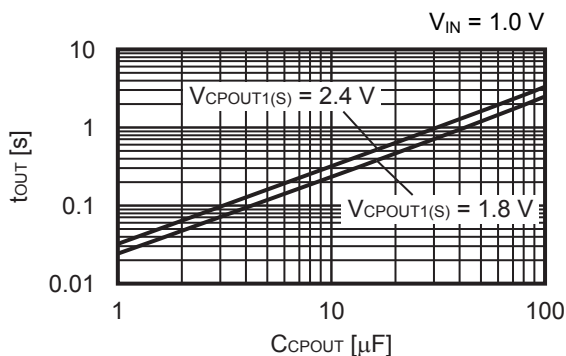
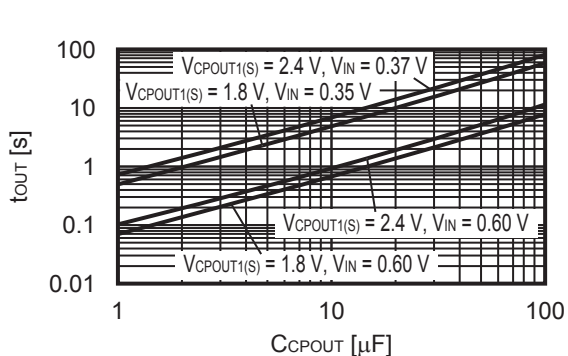

1.4 Current consumption during operation (I_{SS}) vs. Input voltage (V_{IN})

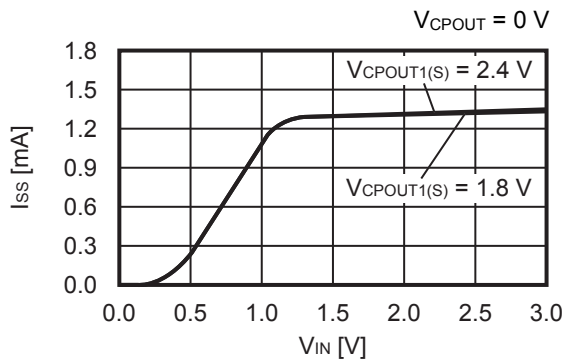

1.5 Current consumption during operation (I_{SS}) vs. CPOUT pin voltage (V_{CPOUT})

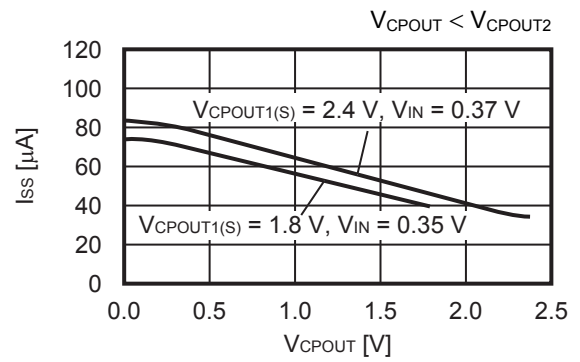

1.6 Current consumption during power-off (I_{SSS}) vs. Input voltage (V_{IN})

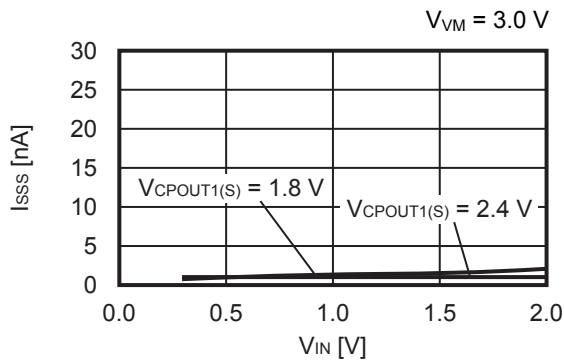

1.7 Power-off voltage (V_{OFF}) vs. Input voltage (V_{IN})

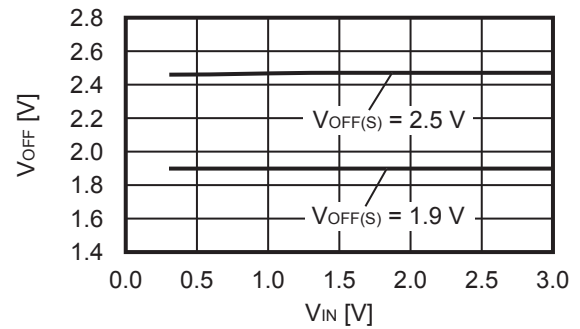

1.8 VM pin input current (I_{VM}) vs. VM pin voltage (V_{VM})

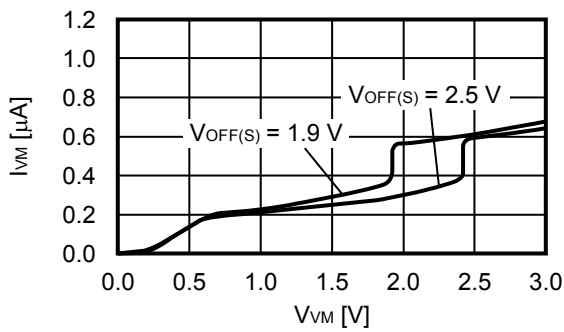

2. Example of major temperature characteristics (Ta = -40°C to +85°C)

2.1 Discharge start voltage (V_{CP_{OUT1}}), discharge stop voltage (V_{CP_{OUT2}}) vs. Temperature (Ta)

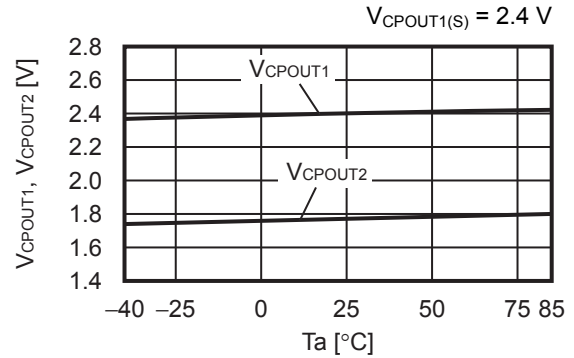
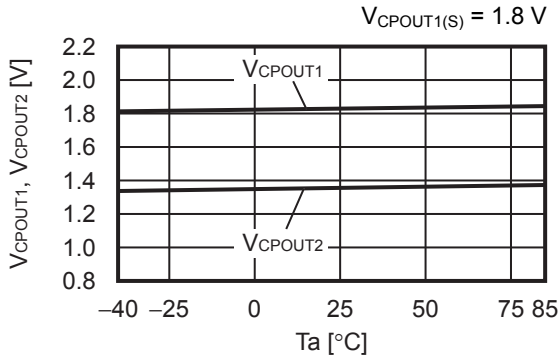

2.2 Discharge start delay time (t_{OUT}) vs. Temperature (Ta)

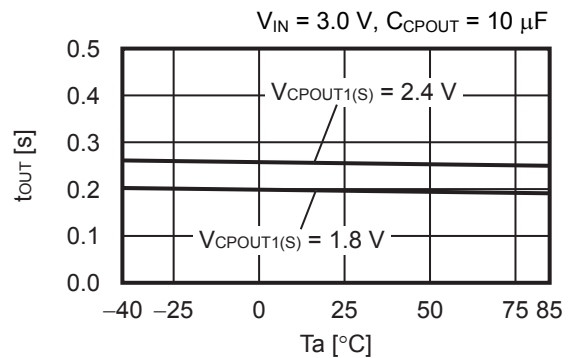
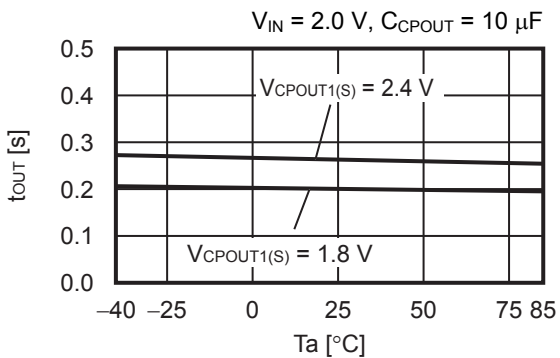
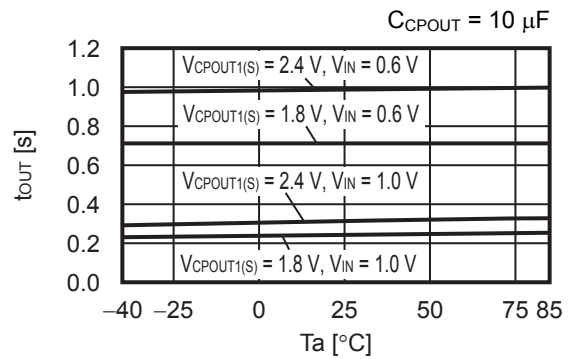
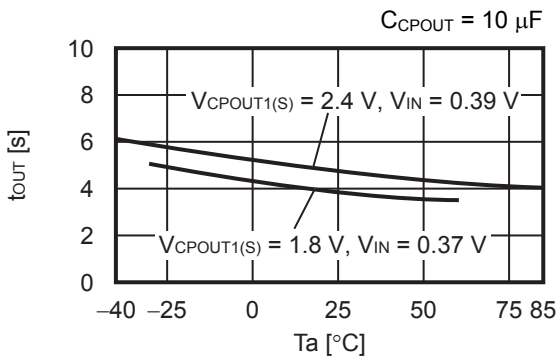

2.3 Current consumption during operation (I_{SS}) vs. Temperature (Ta)

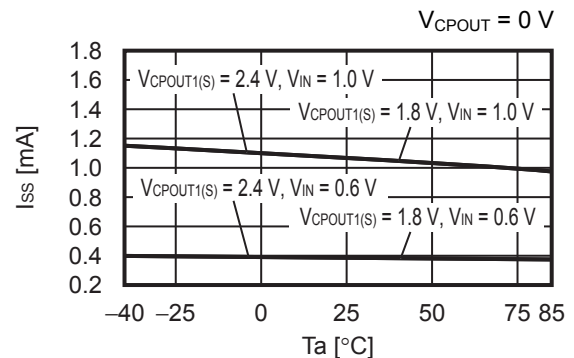
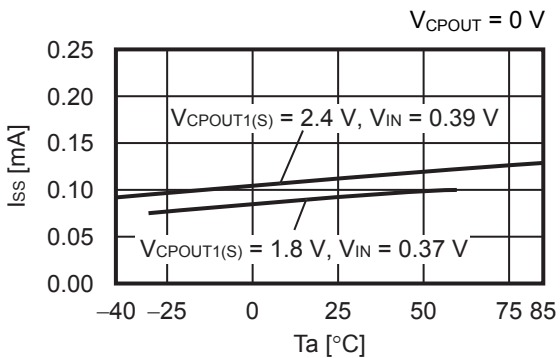

2. 4 Current consumption during power-off (I_{SSS}) vs. Temperature (T_a)

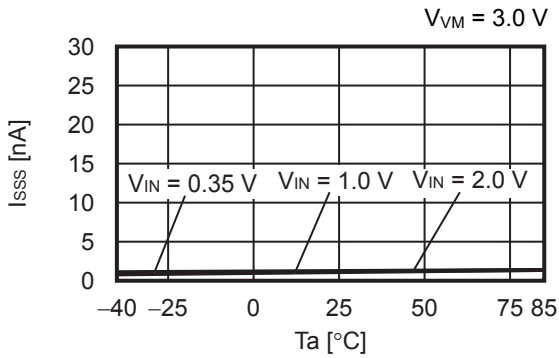

2. 5 Power-off voltage (V_{OFF}) vs. Temperature (T_a)

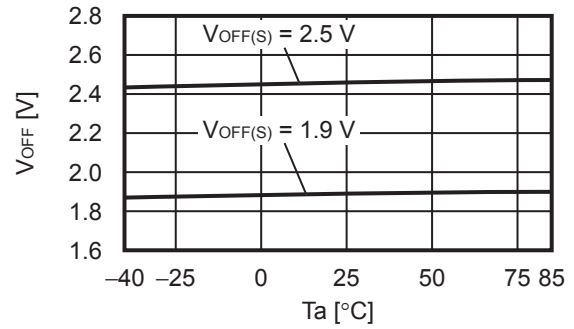

2. 6 Discharge control switch resistance (R_{M1}) vs. Temperature (T_a)

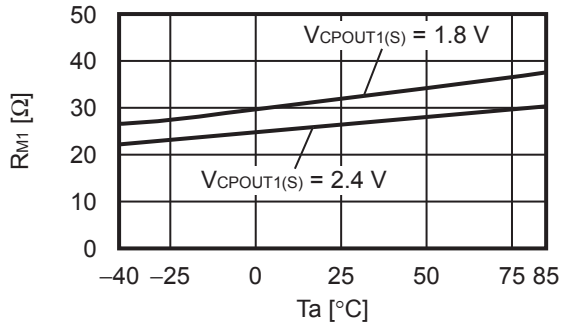

2. 7 Discharge control switch leakage current (I_{LEAK}) vs. Temperature (T_a)

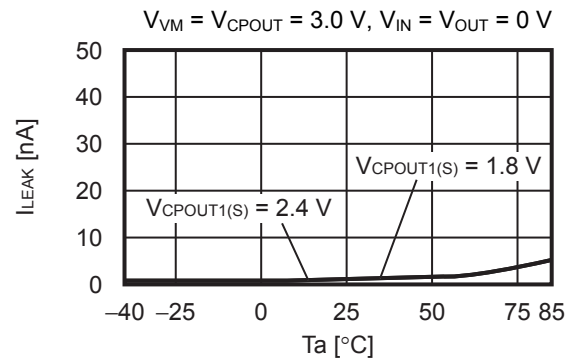

2. 8 VM pin input current (I_{VM}) vs. Temperature (T_a)

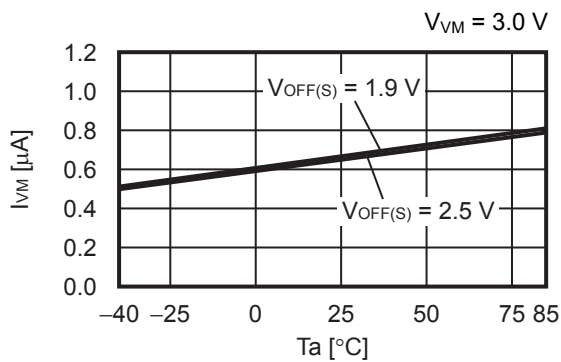

■ Marking Specifications

1. SOT-23-5

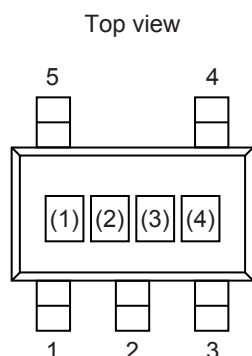

(1) to (3): Product code (Refer to **Product name vs. Product code**)
 (4): Lot number

Product Name vs. Product Code

Product Name	Product Code		
	(1)	(2)	(3)
S-8823A18-M5T1U	Q	Y	U
S-8823A20-M5T1U	Q	Y	V
S-8823A22-M5T1U	Q	Y	W
S-8823A24-M5T1U	Q	Y	X

2. SNT-8A

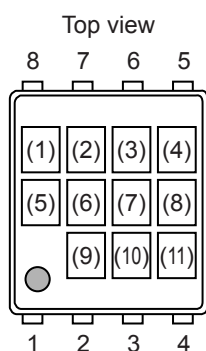

(1): Blank
 (2) to (4): Product code (Refer to **Product name vs. Product code**)
 (5), (6): Blank
 (7) to (11): Lot number

Product Name vs. Product Code

Product Name	Product Code		
	(2)	(3)	(4)
S-8823A18-I8T1U	Q	Y	U
S-8823A20-I8T1U	Q	Y	V
S-8823A22-I8T1U	Q	Y	W
S-8823A24-I8T1U	Q	Y	X

■ Power Dissipation

SOT-23-5

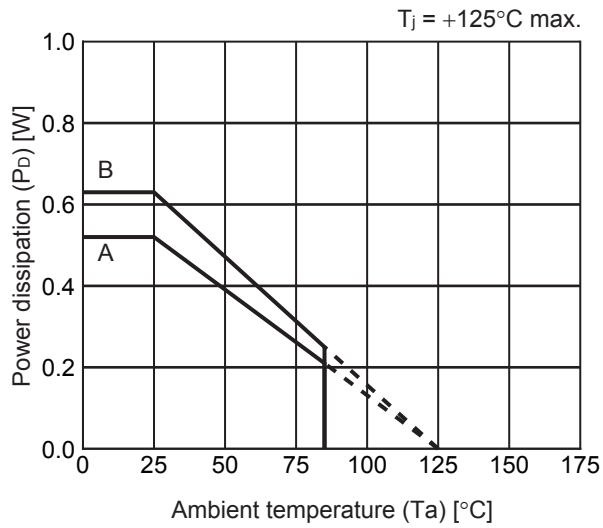

Board	Power Dissipation (P_D)
A	0.52 W
B	0.63 W
C	-
D	-
E	-

SNT-8A

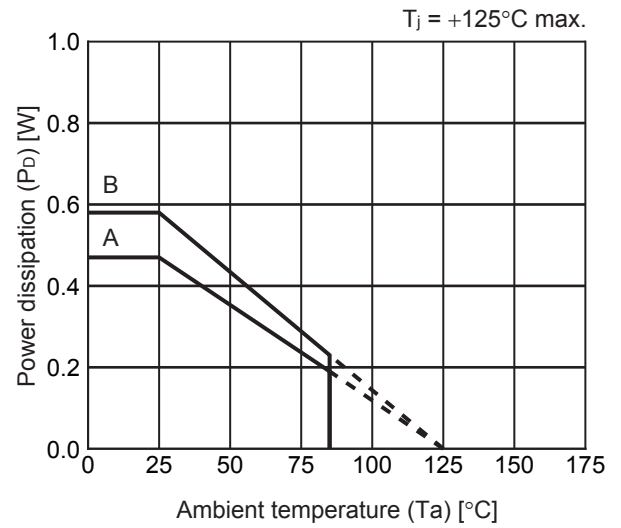

Board	Power Dissipation (P_D)
A	0.47 W
B	0.58 W
C	-
D	-
E	-

SOT-23-3/3S/5/6 Test Board

 IC Mount Area

(1) Board A



Item		Specification
Size [mm]		114.3 x 76.2 x t1.6
Material		FR-4
Number of copper foil layer		2
Copper foil layer [mm]	1	Land pattern and wiring for testing: t0.070
	2	-
	3	-
	4	74.2 x 74.2 x t0.070
Thermal via		-

(2) Board B



Item		Specification
Size [mm]		114.3 x 76.2 x t1.6
Material		FR-4
Number of copper foil layer		4
Copper foil layer [mm]	1	Land pattern and wiring for testing: t0.070
	2	74.2 x 74.2 x t0.035
	3	74.2 x 74.2 x t0.035
	4	74.2 x 74.2 x t0.070
Thermal via		-

No. SOT23x-A-Board-SD-2.0

SNT-8A Test Board

(1) Board A

 IC Mount Area

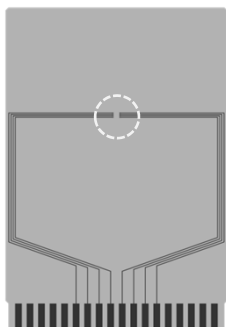

Item	Specification	
Size [mm]	114.3 x 76.2 x t1.6	
Material	FR-4	
Number of copper foil layer	2	
Copper foil layer [mm]	1	Land pattern and wiring for testing: t0.070
	2	-
	3	-
	4	74.2 x 74.2 x t0.070
Thermal via	-	

(2) Board B

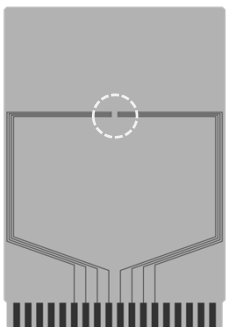

Item	Specification	
Size [mm]	114.3 x 76.2 x t1.6	
Material	FR-4	
Number of copper foil layer	4	
Copper foil layer [mm]	1	Land pattern and wiring for testing: t0.070
	2	74.2 x 74.2 x t0.035
	3	74.2 x 74.2 x t0.035
	4	74.2 x 74.2 x t0.070
Thermal via	-	

No. SNT8A-A-Board-SD-1.0



No. MP005-A-P-SD-1.3

TITLE	SOT235-A-PKG Dimensions
No.	MP005-A-P-SD-1.3
ANGLE	
UNIT	mm
ABLIC Inc.	



Feed direction →

No. MP005-A-C-SD-2.1

TITLE	SOT235-A-Carrier Tape
No.	MP005-A-C-SD-2.1
ANGLE	
UNIT	mm
ABLIC Inc.	



Enlarged drawing in the central part



No. MP005-A-R-SD-1.1

TITLE	SOT235-A-Reel		
No.	MP005-A-R-SD-1.1		
ANGLE		QTY.	3,000
UNIT	mm		
ABLIC Inc.			

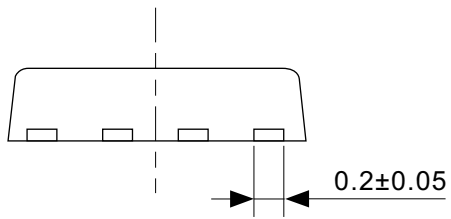
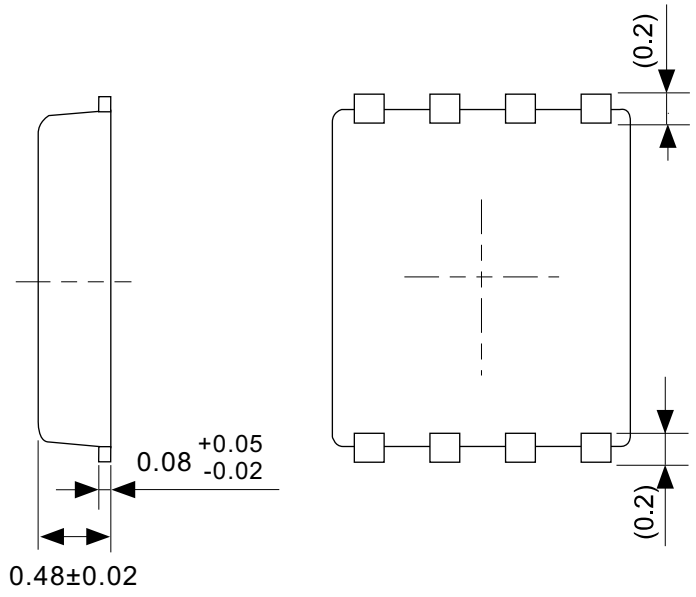
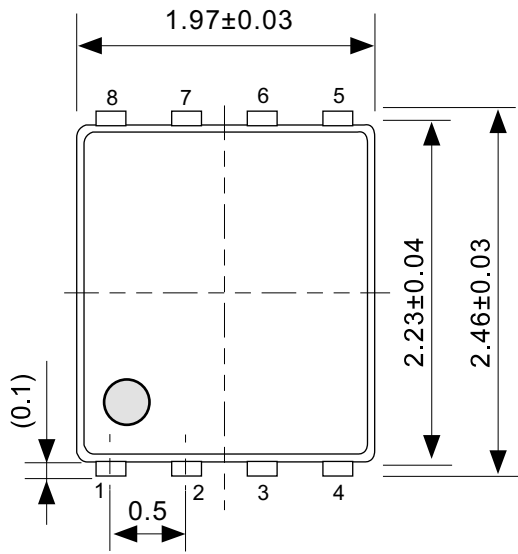

No. PH008-A-P-SD-2.1

TITLE	SNT-8A-A-PKG Dimensions
No.	PH008-A-P-SD-2.1
ANGLE	
UNIT	mm
ABLIC Inc.	

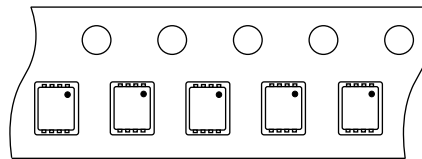
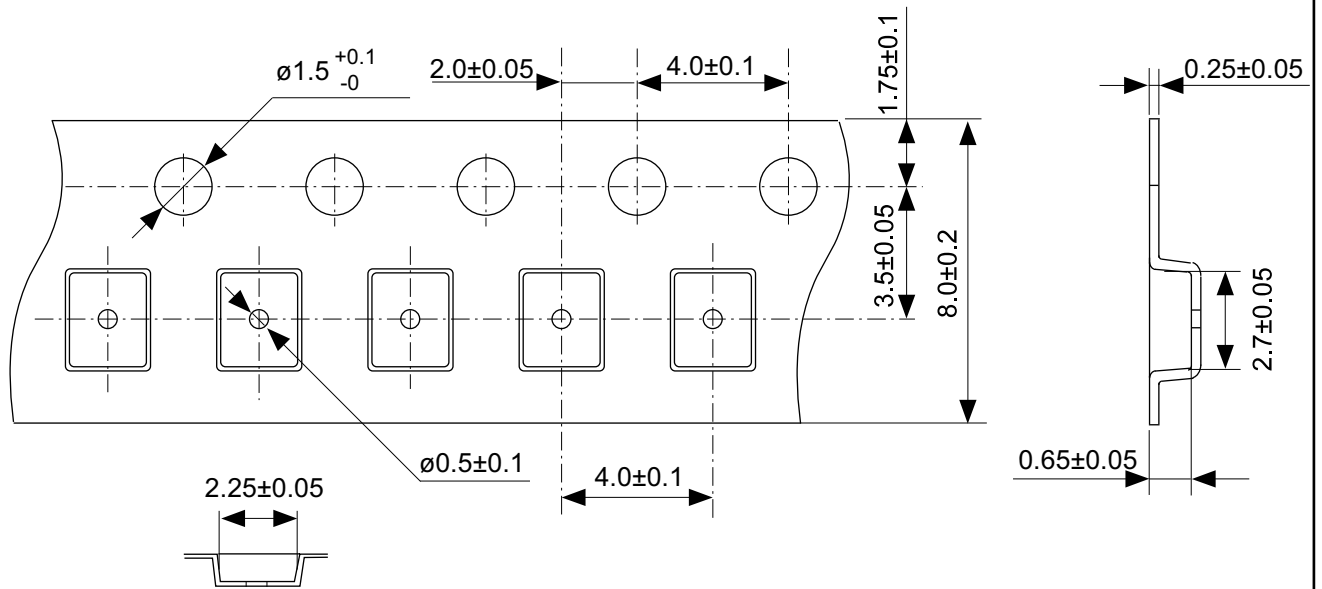

Feed direction

No. PH008-A-C-SD-2.0

TITLE	SNT-8A-A-Carrier Tape
No.	PH008-A-C-SD-2.0
ANGLE	
UNIT	mm
ABLIC Inc.	

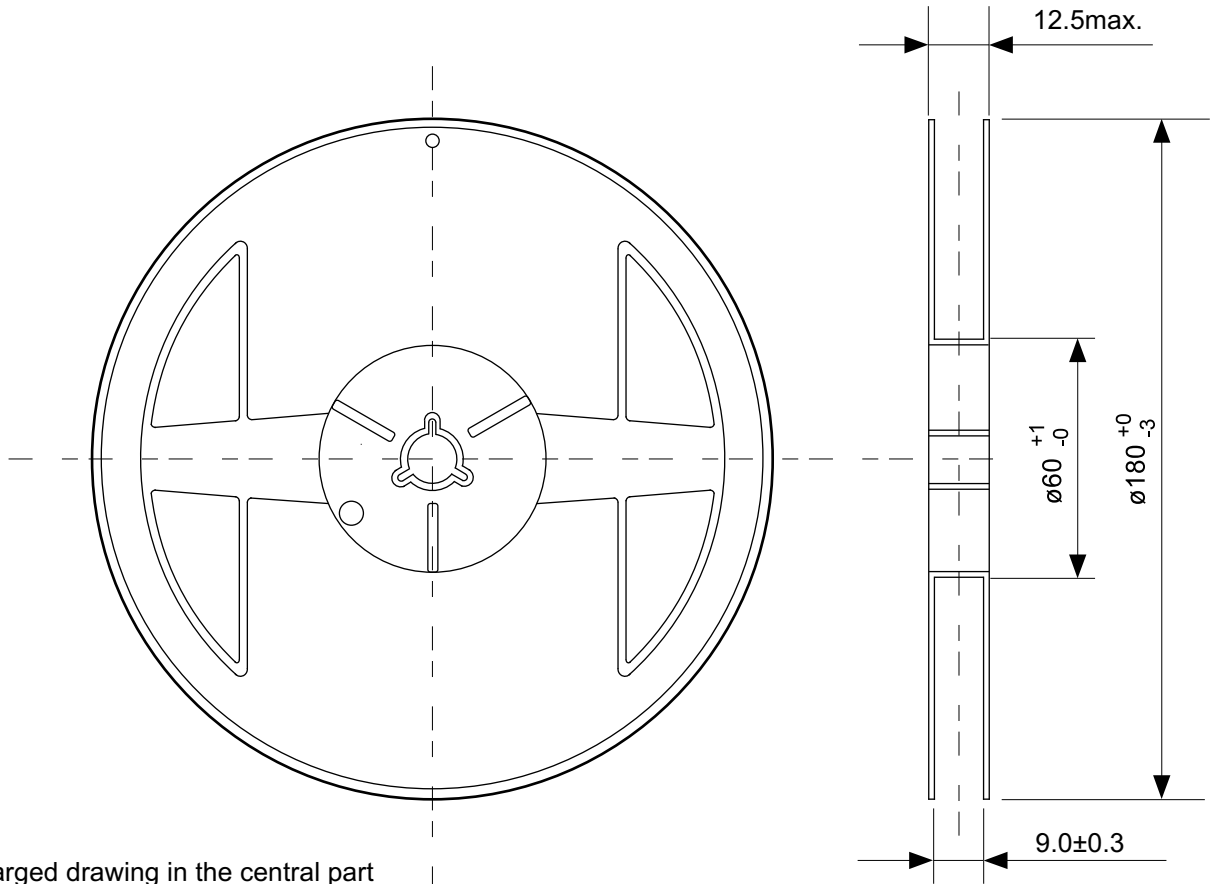

Enlarged drawing in the central part

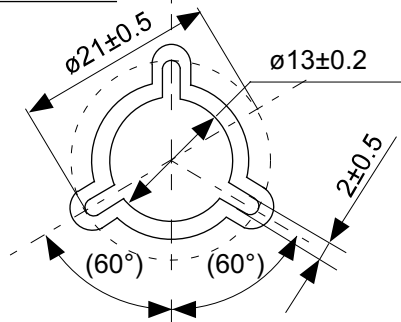

No. PH008-A-R-SD-1.0

TITLE	SNT-8A-A-Reel		
No.	PH008-A-R-SD-1.0		
ANGLE		QTY.	5,000
UNIT	mm		
ABLIC Inc.			



※1. ランドパターンの幅に注意してください (0.25 mm min. / 0.30 mm typ.).
 ※2. パッケージ中央にランドパターンを広げないでください (1.96 mm ~ 2.06 mm)。

- 注意
1. パッケージのモールド樹脂下にシルク印刷やハンダ印刷などしないでください。
 2. パッケージ下の配線上のソルダーレジストなどの厚みをランドパターン表面から0.03 mm以下にしてください。
 3. マスク開口サイズと開口位置はランドパターンと合わせてください。
 4. 詳細は“SNTパッケージ活用の手引き”を参照してください。

※1. Pay attention to the land pattern width (0.25 mm min. / 0.30 mm typ.).
 ※2. Do not widen the land pattern to the center of the package (1.96 mm to 2.06mm).

- Caution**
1. Do not do silkscreen printing and solder printing under the mold resin of the package.
 2. The thickness of the solder resist on the wire pattern under the package should be 0.03 mm or less from the land pattern surface.
 3. Match the mask aperture size and aperture position with the land pattern.
 4. Refer to "SNT Package User's Guide" for details.

※1. 请注意焊盘模式的宽度 (0.25 mm min. / 0.30 mm typ.).
 ※2. 请勿向封装中间扩展焊盘模式 (1.96 mm ~ 2.06 mm)。

- 注意
1. 请勿在树脂型封装的下面印刷丝网、焊锡。
 2. 在封装下、布线上的阻焊膜厚度 (从焊盘模式表面起) 请控制在 0.03 mm 以下。
 3. 钢网的开口尺寸和开口位置请与焊盘模式对齐。
 4. 详细内容请参阅 "SNT 封装的应用指南"。

No. PH008-A-L-SD-4.1

TITLE	SNT-8A-A -Land Recommendation
No.	PH008-A-L-SD-4.1
ANGLE	
UNIT	mm
ABLIC Inc.	

Disclaimers (Handling Precautions)

1. All the information described herein (product data, specifications, figures, tables, programs, algorithms and application circuit examples, etc.) is current as of publishing date of this document and is subject to change without notice.
2. The circuit examples and the usages described herein are for reference only, and do not guarantee the success of any specific mass-production design.
ABLIC Inc. is not responsible for damages caused by the reasons other than the products described herein (hereinafter "the products") or infringement of third-party intellectual property right and any other right due to the use of the information described herein.
3. ABLIC Inc. is not responsible for damages caused by the incorrect information described herein.
4. Be careful to use the products within their specified ranges. Pay special attention to the absolute maximum ratings, operation voltage range and electrical characteristics, etc.
ABLIC Inc. is not responsible for damages caused by failures and / or accidents, etc. that occur due to the use of the products outside their specified ranges.
5. When using the products, confirm their applications, and the laws and regulations of the region or country where they are used and verify suitability, safety and other factors for the intended use.
6. When exporting the products, comply with the Foreign Exchange and Foreign Trade Act and all other export-related laws, and follow the required procedures.
7. The products must not be used or provided (exported) for the purposes of the development of weapons of mass destruction or military use. ABLIC Inc. is not responsible for any provision (export) to those whose purpose is to develop, manufacture, use or store nuclear, biological or chemical weapons, missiles, or other military use.
8. The products are not designed to be used as part of any device or equipment that may affect the human body, human life, or assets (such as medical equipment, disaster prevention systems, security systems, combustion control systems, infrastructure control systems, vehicle equipment, traffic systems, in-vehicle equipment, aviation equipment, aerospace equipment, and nuclear-related equipment), excluding when specified for in-vehicle use or other uses. Do not apply the products to the above listed devices and equipments without prior written permission by ABLIC Inc. Especially, the products cannot be used for life support devices, devices implanted in the human body and devices that directly affect human life, etc.
Prior consultation with our sales office is required when considering the above uses.
ABLIC Inc. is not responsible for damages caused by unauthorized or unspecified use of our products.
9. Semiconductor products may fail or malfunction with some probability.
The user of the products should therefore take responsibility to give thorough consideration to safety design including redundancy, fire spread prevention measures, and malfunction prevention to prevent accidents causing injury or death, fires and social damage, etc. that may ensue from the products' failure or malfunction.
The entire system must be sufficiently evaluated and applied on customer's own responsibility.
10. The products are not designed to be radiation-proof. The necessary radiation measures should be taken in the product design by the customer depending on the intended use.
11. The products do not affect human health under normal use. However, they contain chemical substances and heavy metals and should therefore not be put in the mouth. The fracture surfaces of wafers and chips may be sharp. Be careful when handling these with the bare hands to prevent injuries, etc.
12. When disposing of the products, comply with the laws and ordinances of the country or region where they are used.
13. The information described herein contains copyright information and know-how of ABLIC Inc.
The information described herein does not convey any license under any intellectual property rights or any other rights belonging to ABLIC Inc. or a third party. Reproduction or copying of the information from this document or any part of this document described herein for the purpose of disclosing it to a third-party without the express permission of ABLIC Inc. is strictly prohibited.
14. For more details on the information described herein, contact our sales office.

2.0-2018.01