

TOSHIBA RF POWER AMPLIFIER MODULE

**S-AV7**

VHF HAM FM RF POWER AMPLIFIER MODULE

Unit in mm

- High Gain :  $P_o \geq 28W$ ,  $G_p \geq 21.4dB$ ,  $\eta_T \geq 45\%$

**MAXIMUM RATINGS (Tc = 25°C)**

CHARACTERISTIC	SYMBOL	RATING	UNIT
DC Supply Voltage	V <sub>CC</sub>	16	V
DC Supply Voltage	V <sub>CON</sub>	16	V
Input Power	P <sub>i</sub>	300	mW
Operating Case Temperature Range	T <sub>c (opr)</sub>	-30~100	°C
Storage Temperature Range	T <sub>stg</sub>	-40~110	°C

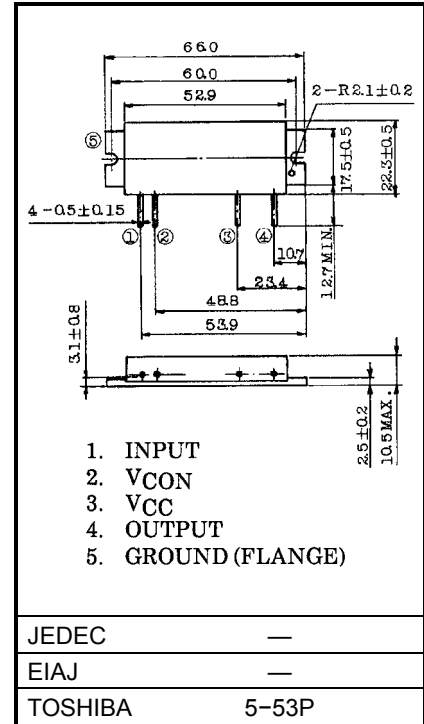

**ELECTRICAL CHARACTERISTICS (Tc = 25°C)**

Weight: 35g

CHARACTERISTIC	SYMBOL	TEST CONDITION	MIN.	TYP.	MAX.	UNIT
Frequency Range	f <sub>range</sub>	—	144	—	148	MHz
Output Power	P <sub>o</sub>	P <sub>i</sub> = 200mW V <sub>CC</sub> = 12.5V, V <sub>CON</sub> = 12.5V Z <sub>G</sub> = Z <sub>L</sub> = 50Ω	28	33	—	W
Power Gain	G <sub>p</sub>		21.4	22.2	—	dB
Total Efficiency	η <sub>T</sub>		45	52	—	%
Input VSWR	VSWR <sub>in</sub>		—	1.5	2	—
Harmonics	HRM		—	-30	-25	dB
Load Mismatch	—	V <sub>CC</sub> = 15V, V <sub>CON</sub> = 12.5V P <sub>o</sub> = 30W (P <sub>i</sub> = adjust) VSWR load 20: 1 all phase	No Degradation			—
Power Slump	—	T <sub>c</sub> = -30~80°C, V <sub>CC</sub> = 12.5V P <sub>i</sub> = 200mW, P <sub>o</sub> = 28W (@T <sub>c</sub> = 25°C)	—	0.8	—	dB
Stability	—	V <sub>CC</sub> = 12.5V, P <sub>i</sub> = 200mW V <sub>CON</sub> = 0~12.5V VSWR load 3: 1 all phase	All spurious output than 60dB below desired signal			—

000707EAA2

• TOSHIBA is continually working to improve the quality and reliability of its products. Nevertheless, semiconductor devices in general can malfunction or fail due to their inherent electrical sensitivity and vulnerability to physical stress. It is the responsibility of the buyer, when utilizing TOSHIBA products, to comply with the standards of safety in making a safe design for the entire system, and to avoid situations in which a malfunction or failure of such TOSHIBA products could cause loss of human life, bodily injury or damage to property. In developing your designs, please ensure that TOSHIBA products are used within specified operating ranges as set forth in the most recent TOSHIBA products specifications. Also, please keep in mind the precautions and conditions set forth in the "Handling Guide for Semiconductor Devices," or "TOSHIBA Semiconductor Reliability Handbook" etc..

## CAUTION

- This product has intersetting cap. Please pay attention for exceeding stress and foreign matter in your application. And not to take away the cap.
- Beryllia Ceramics is used in this product. The dust or vapor can be dangerous to humans. Do not break, cut, crush or dissolve chemically. Dispose of this product properly according to law. Do not intermingle with normal industrial or domestic waste.

## SCHEMATIC

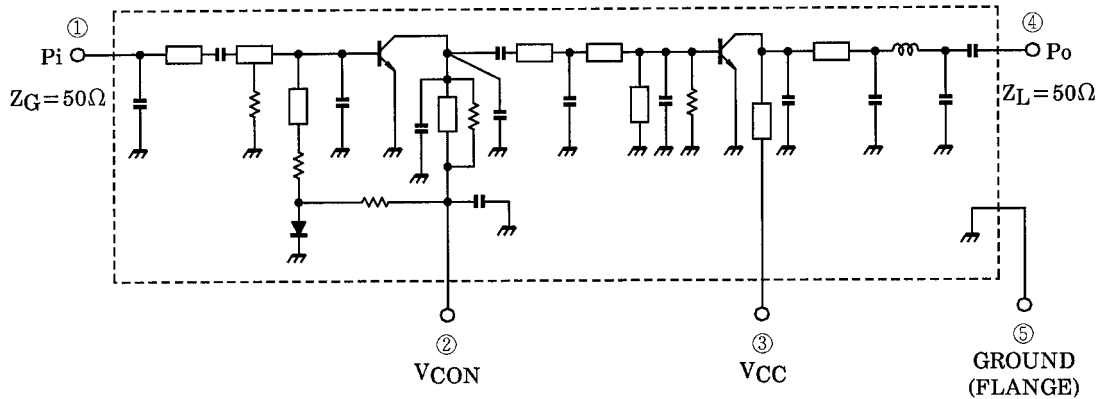

## TEST FIXTURE

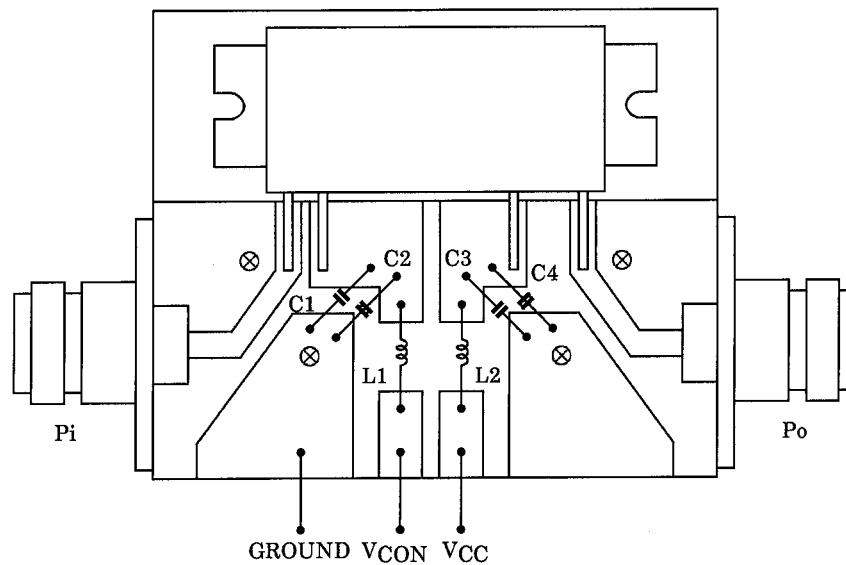

C1, C3 : 15000pF  
 C2, C4 : 10 $\mu$ F  
 L1, L2 :  $\phi$ 0.8 ENAMEL WIRE, 8T, 5ID

000707EAA2

- The TOSHIBA products listed in this document are intended for usage in general electronics applications (computer, personal equipment, office equipment, measuring equipment, industrial robotics, domestic appliances, etc.). These TOSHIBA products are neither intended nor warranted for usage in equipment that requires extraordinarily high quality and/or reliability or a malfunction or failure of which may cause loss of human life or bodily injury ("Unintended Usage"). Unintended Usage include atomic energy control instruments, airplane or spaceship instruments, transportation instruments, traffic signal instruments, combustion control instruments, medical instruments, all types of safety devices, etc.. Unintended Usage of TOSHIBA products listed in this document shall be made at the customer's own risk.
- The information contained herein is presented only as a guide for the applications of our products. No responsibility is assumed by TOSHIBA CORPORATION for any infringements of intellectual property or other rights of the third parties which may result from its use. No license is granted by implication or otherwise under any intellectual property or other rights of TOSHIBA CORPORATION or others.
- The information contained herein is subject to change without notice.

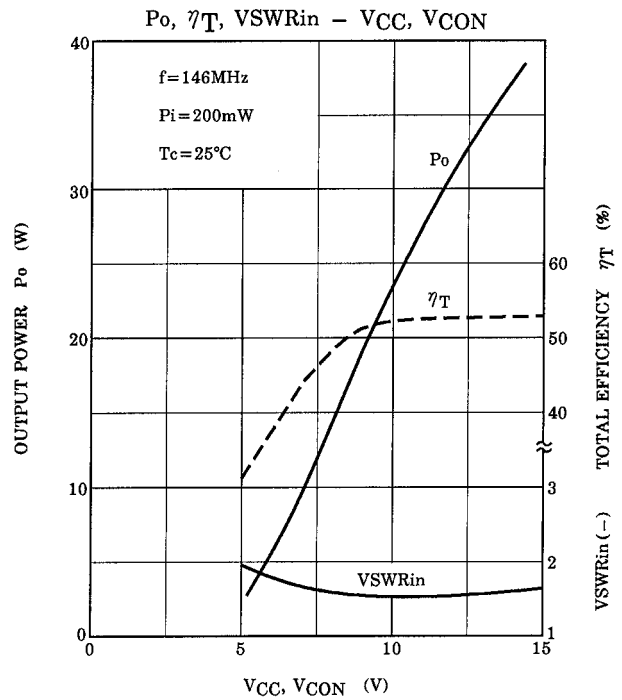
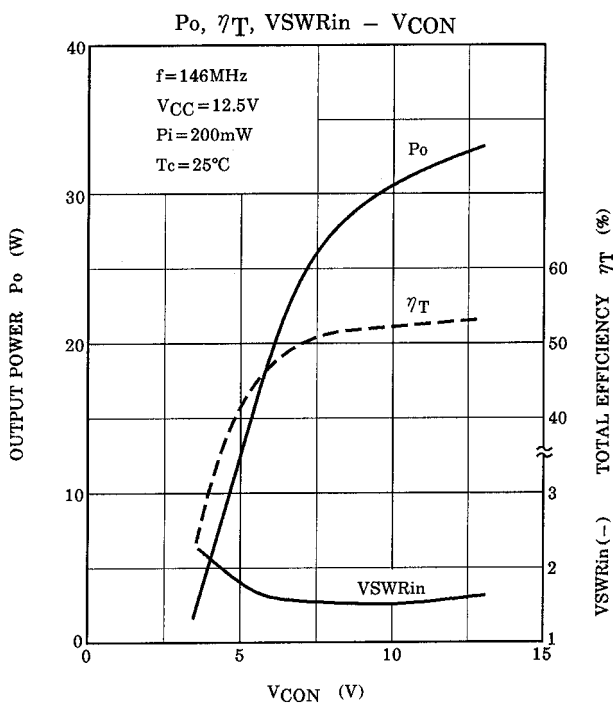
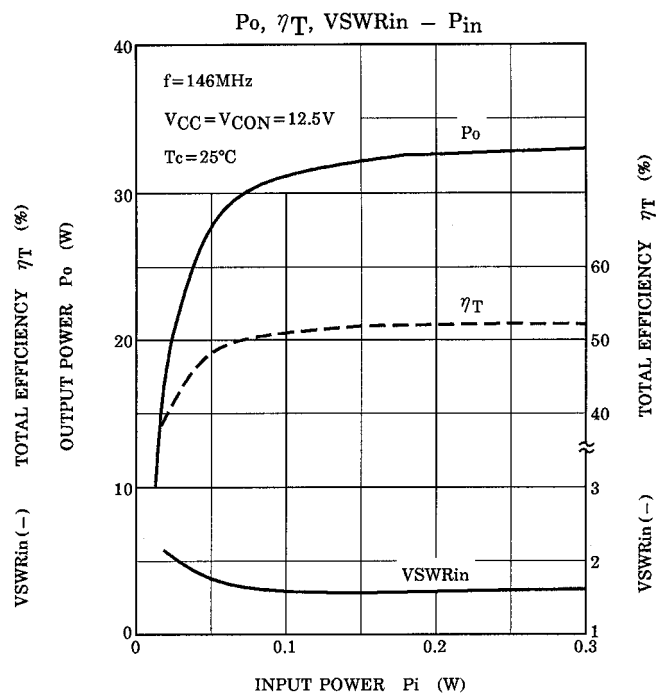
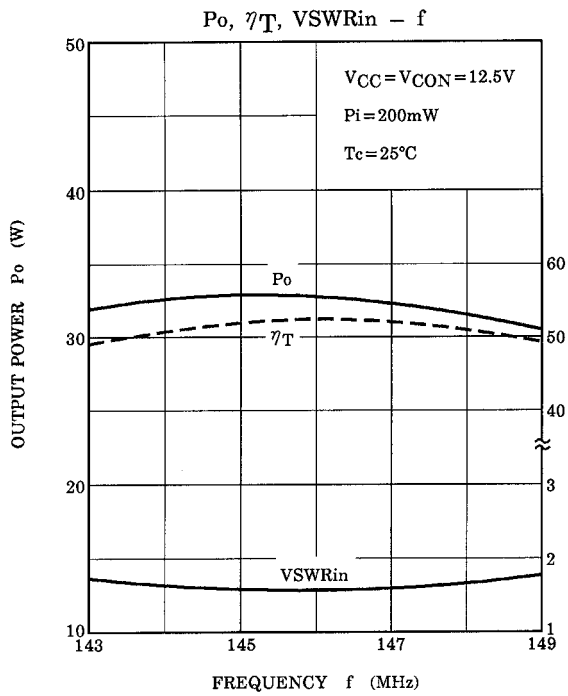

## CAUTION

These are only typical curves and devices are not necessarily guaranteed at these curves.