

30V P-Channel Enhancement-Mode MOSFET

V_{DS}	-30V
I_D ($V_{GS} = -10V$)	-4.1A
$R_{DS(ON)}$ ($V_{GS} = -10V$)	< 70m Ω
$R_{DS(ON)}$ ($V_{GS} = -4.5V$)	< 100m Ω

FEATURES

The LP3407LT1G uses advanced trench technology to provide excellent $R_{DS(ON)}$ with low gate charge. This device is suitable for use as a load switch or in PWM applications.

S- Prefix for Automotive and Other Applications Requiring Unique Site and Control Change Requirements; AEC-Q101 Qualified and PPAP Capable.

ORDERING INFORMATION

Device	Marking	Shipping
LP3407LT1G S-LP3407LT1G	A07	3000/Tape&Reel
LP3407LT3G S-LP3407LT3G	A07	10000/Tape&Reel

LP3407LT1G
S-LP3407LT1G

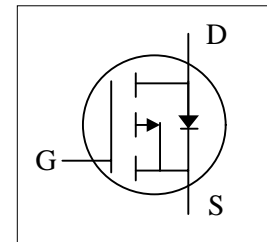
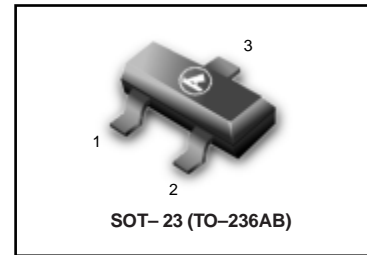

MAXIMUM RATINGS ($T_A = 25^\circ\text{C}$ unless otherwise noted)

Parameter	Symbol	Maximum	Units
Drain-Source Voltage	V_{DS}	-30	V
Gate-Source Voltage	V_{GS}	± 20	V
Continuous Drain Current	I_D	$T_A = 25^\circ\text{C}$	-4.1
		$T_A = 70^\circ\text{C}$	-3.5
Pulsed Drain Current ^C	I_{DM}	-25	A
Power Dissipation ^B	P_D	$T_A = 25^\circ\text{C}$	1.4
		$T_A = 70^\circ\text{C}$	0.9
Junction and Storage Temperature Range	T_J, T_{STG}	-55 to 150	$^\circ\text{C}$

THERMAL CHARACTERISTICS ($T_A = 25^\circ\text{C}$ unless otherwise noted)

Thermal Characteristics					
Parameter		Symbol	Typ	Max	Units
Maximum Junction-to-Ambient ^A	$t \leq 10\text{s}$	$R_{\theta JA}$	70	90	$^\circ\text{C/W}$
	Steady-State		100	125	$^\circ\text{C/W}$
Maximum Junction-to-Lead	Steady-State	$R_{\theta JL}$	63	80	$^\circ\text{C/W}$

A: The value of $R_{\theta JA}$ is measured with the device mounted on 1in² FR-4 board with 2oz. Copper, in a still air environment with $T_A = 25^\circ\text{C}$. The value in any given application depends on the user's specific board design. The current rating is based on the $t \leq 10\text{s}$ thermal resistance rating.

B: Repetitive rating, pulse width limited by junction temperature.

C: The $R_{\theta JA}$ is the sum of the thermal impedance from junction to lead $R_{\theta JL}$ and lead to ambient.

ELECTRICAL CHARACTERISTICS ($T_A = 25^\circ\text{C}$ unless otherwise noted)

Symbol	Parameter	Conditions	Min	Typ	Max	Units
STATIC PARAMETERS						
BV_{DSS}	Drain-Source Breakdown Voltage	$I_D = -250\mu\text{A}, V_{GS} = 0\text{V}$	-30			V
I_{DSS}	Zero Gate Voltage Drain Current	$V_{DS} = -24\text{V}, V_{GS} = 0\text{V}$ $T_J = 55^\circ\text{C}$			-1	μA
					-5	
I_{GSS}	Gate-Body leakage current	$V_{DS} = 0\text{V}, V_{GS} = \pm 20\text{V}$			± 100	nA
$V_{GS(th)}$	Gate Threshold Voltage	$V_{DS} = V_{GS}, I_D = -250\mu\text{A}$	-1	-2	-3	V
$I_{D(ON)}$	On state drain current	$V_{GS} = -10\text{V}, V_{DS} = -5\text{V}$	-25			A
$R_{DS(ON)}$	Static Drain-Source On-Resistance	$V_{GS} = -10\text{V}, I_D = -4.1\text{A}$ $T_J = 125^\circ\text{C}$			70	m Ω
					95	
		$V_{GS} = -4.5\text{V}, I_D = -3\text{A}$			100	m Ω
g_{FS}	Forward Transconductance	$V_{DS} = -5\text{V}, I_D = -4\text{A}$		10		S
V_{SD}	Diode Forward Voltage	$I_S = -1\text{A}, V_{GS} = 0\text{V}$		-0.7	-1	V
I_S	Maximum Body-Diode Continuous Current				-2	A
DYNAMIC PARAMETERS						
C_{iss}	Input Capacitance	$V_{GS} = 0\text{V}, V_{DS} = -15\text{V}, f = 1\text{MHz}$	415	520	625	pF
C_{oss}	Output Capacitance		70	100	130	pF
C_{rss}	Reverse Transfer Capacitance		40	65	90	pF
R_g	Gate resistance	$V_{GS} = 0\text{V}, V_{DS} = 0\text{V}, f = 1\text{MHz}$	3.5	7.5	11.5	Ω
SWITCHING PARAMETERS						
$Q_g(10\text{V})$	Total Gate Charge	$V_{GS} = -10\text{V}, V_{DS} = -15\text{V}, I_D = -4\text{A}$	7.4	9.2	11	nC
$Q_g(4.5\text{V})$	Total Gate Charge		3.7	4.6	6	nC
Q_{gs}	Gate Source Charge		1.3	1.6	1.9	nC
Q_{gd}	Gate Drain Charge		1.3	2.2	3.1	nC
$t_{D(on)}$	Turn-On DelayTime	$V_{GS} = -10\text{V}, V_{DS} = -15\text{V}, R_L = 3.6\Omega,$ $R_{GEN} = 3\Omega$		7.5		ns
t_r	Turn-On Rise Time			5.5		ns
$t_{D(off)}$	Turn-Off DelayTime			19		ns
t_f	Turn-Off Fall Time			7		ns
t_{rr}	Body Diode Reverse Recovery Time	$I_F = -4\text{A}, dI/dt = 100\text{A}/\mu\text{s}$	8.8	11	13	ns
Q_{rr}	Body Diode Reverse Recovery Charge	$I_F = -4\text{A}, dI/dt = 100\text{A}/\mu\text{s}$	4	5.3	6.4	nC

LP3407LT1G , S-LP3407LT1G

TYPICAL ELECTRICAL CHARACTERISTICS

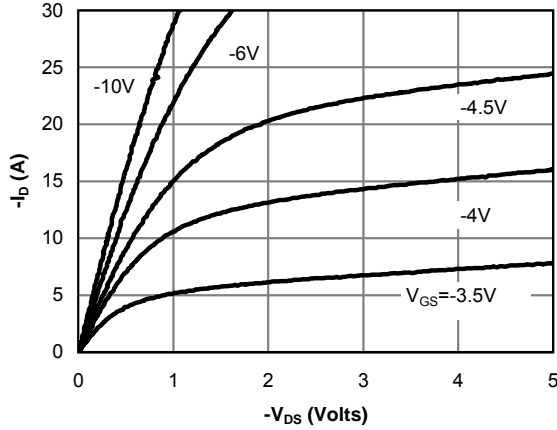

Figure 1: On-Region Characteristics (Note E)

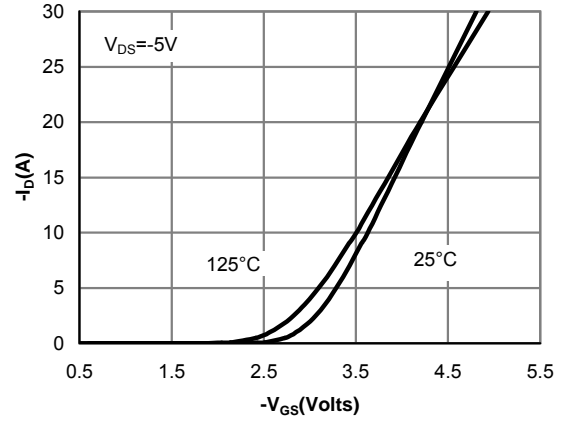

Figure 2: Transfer Characteristics (Note E)

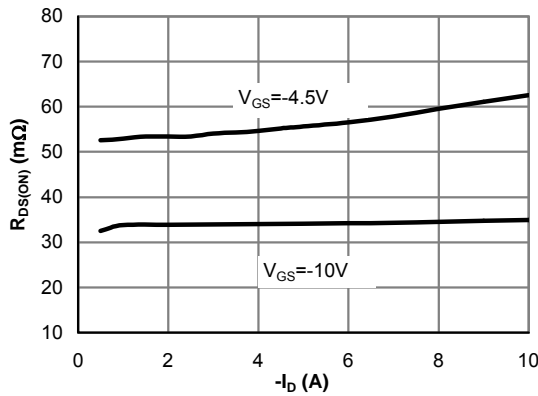

Figure 3: On-Resistance vs. Drain Current and Gate Voltage (Note E)

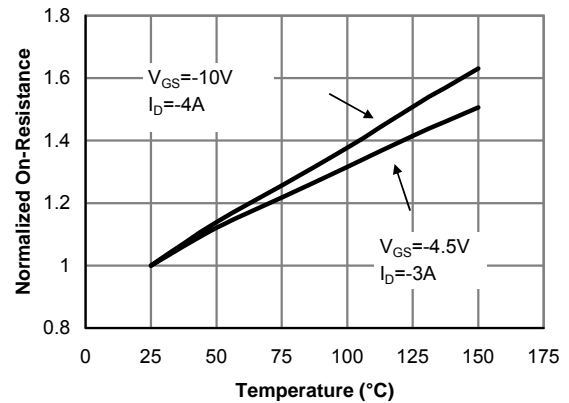

Figure 4: On-Resistance vs. Junction Temperature (Note E)

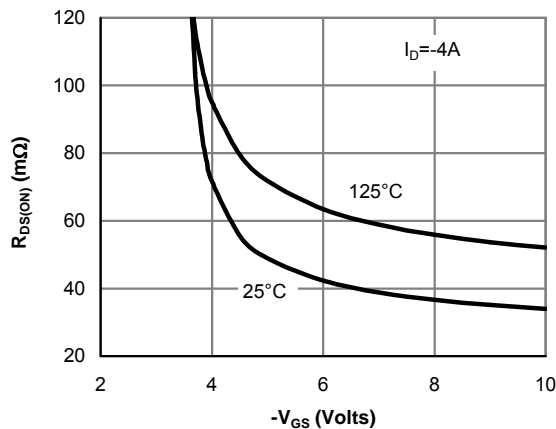

Figure 5: On-Resistance vs. Gate-Source Voltage (Note E)

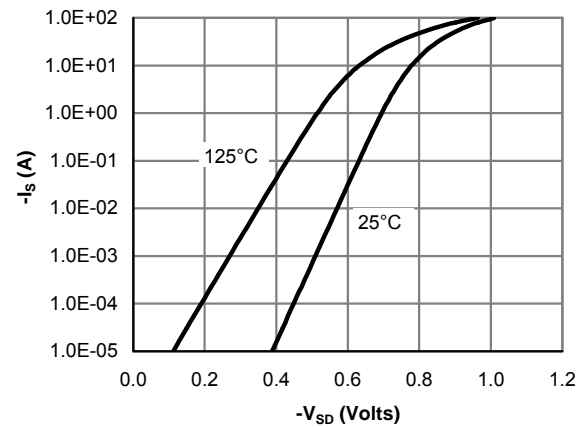

Figure 6: Body-Diode Characteristics (Note E)

TYPICAL ELECTRICAL CHARACTERISTICS

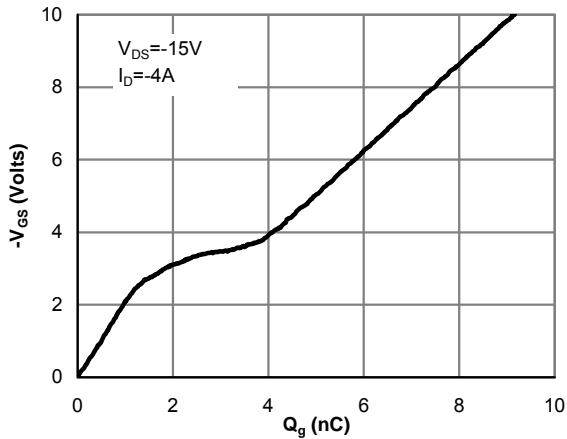

Figure 7: Gate-Charge Characteristics

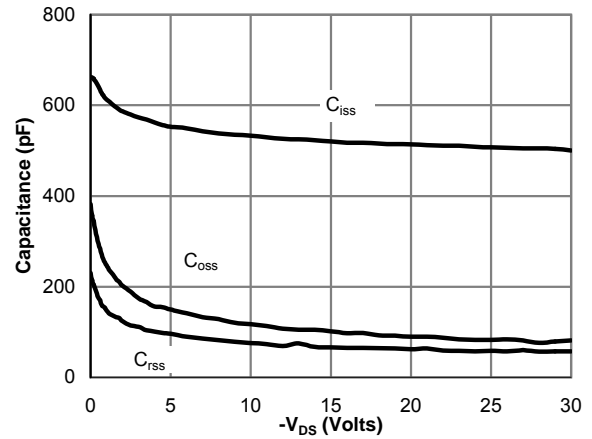

Figure 8: Capacitance Characteristics

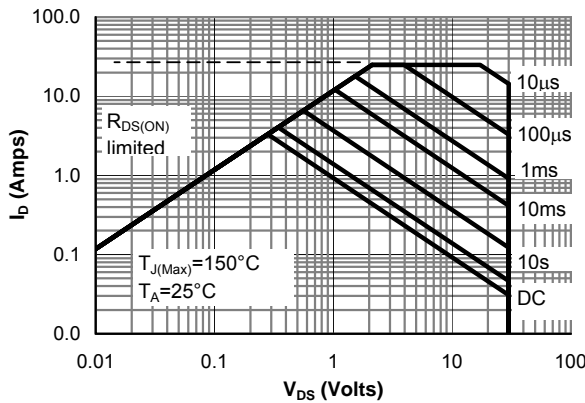

Figure 9: Maximum Forward Biased Safe Operating Area (Note F)

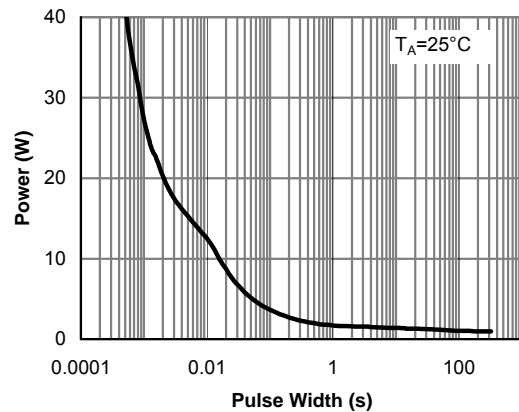

Figure 10: Single Pulse Power Rating Junction-to-Ambient (Note F)

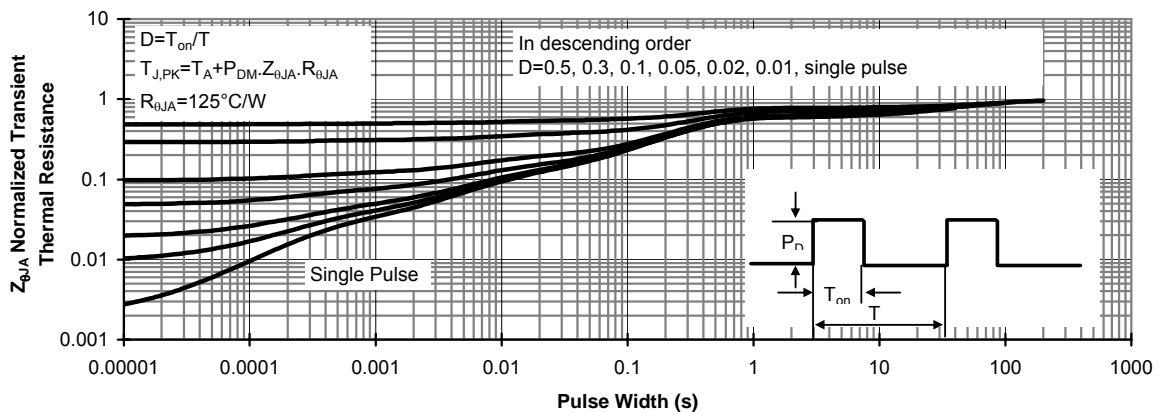
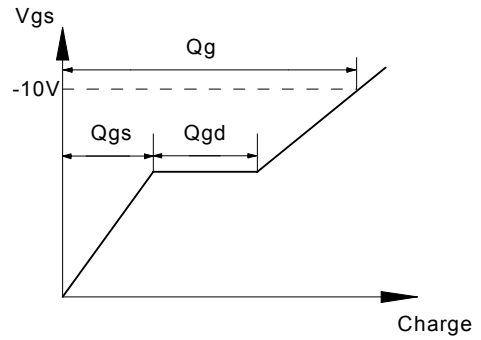
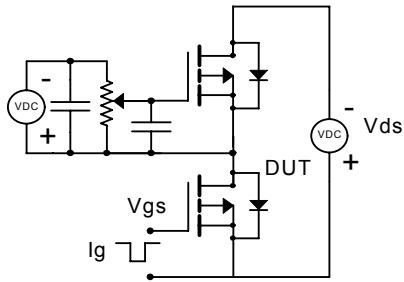

Figure 11: Normalized Maximum Transient Thermal Impedance (Note F)

LP3407LT1G , S-LP3407LT1G

Gate Charge Test Circuit & Waveform



Resistive Switching Test Circuit & Waveforms

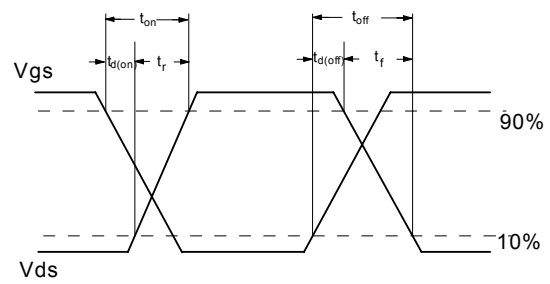
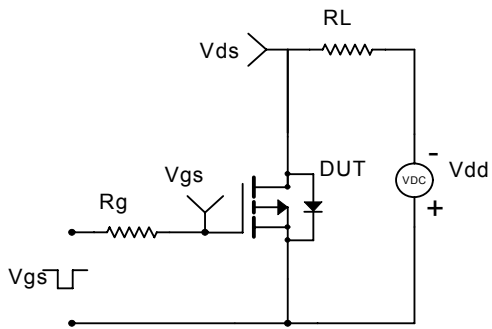

Diode Recovery Test Circuit & Waveforms

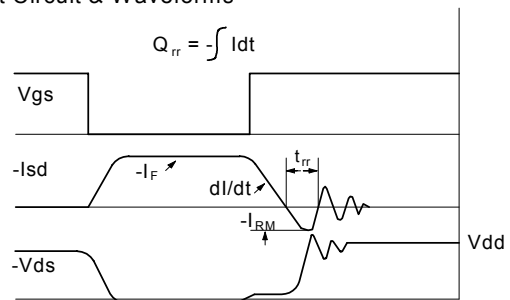
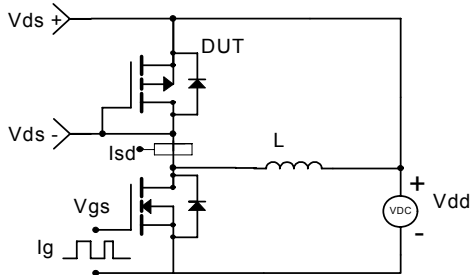

LP3407LT1G , S-LP3407LT1G

SOT-23

NOTES:

1. DIMENSIONING AND TOLERANCING PER ANSI Y14.5M,1982
2. CONTROLLING DIMENSION: INCH.

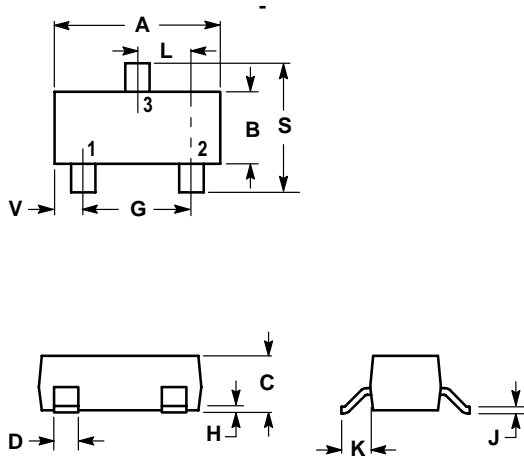

DIM	INCHES		MILLIMETERS	
	MIN	MAX	MIN	MAX
A	0.1102	0.1197	2.80	3.04
B	0.0472	0.0551	1.20	1.40
C	0.0350	0.0440	0.89	1.11
D	0.0150	0.0200	0.37	0.50
G	0.0701	0.0807	1.78	2.04
H	0.0005	0.0040	0.013	0.100
J	0.0034	0.0070	0.085	0.177
K	0.0140	0.0285	0.35	0.69
L	0.0350	0.0401	0.89	1.02
S	0.0830	0.1039	2.10	2.64
V	0.0177	0.0236	0.45	0.60

