

N-Channel 1.8-V (G-S) MOSFET

LSI1012LT1G
S-LSI1012LT1G

FEATURES

- TrenchFET® Power MOSFET: 1.8-V Rated
- Gate-Source ESD Protected: 2000 V
- High-Side Switching
- Low On-Resistance: 0.7 Ω
- Low Threshold: 0.8 V (typ)
- Fast Switching Speed: 10 ns
- S- Prefix for Automotive and Other Applications Requiring Unique Site and Control Change Requirements; AEC-Q101 Qualified and PPAP Capable.

BENEFITS

- Ease in Driving Switches
- Low Offset (Error) Voltage
- Low-Voltage Operation
- High-Speed Circuits
- Low Battery Voltage Operation

APPLICATIONS

- Drivers: Relays, Solenoids, Lamps, Hammers, Displays, Memories
- Battery Operated Systems
- Power Supply Converter Circuits
- Load/Power Switching Cell Phones, Pagers

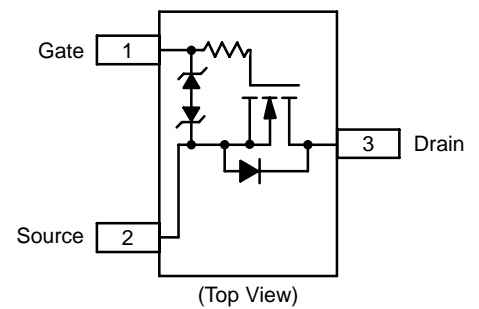
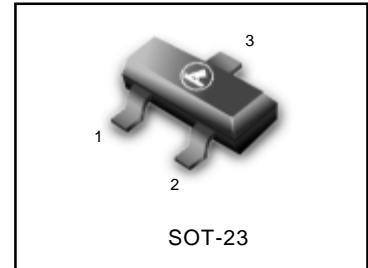

MARKING DIAGRAM

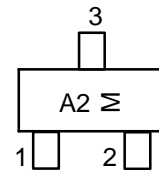

A2 = Specific Device Code
M = Month Code

ORDERING INFORMATION

Device	Marking	Shipping
LSI1012LT1G S-LSI1012LT1G	A2	3000/Tape&Reel
LSI1012LT3G S-LSI1012LT3G	A2	10000/Tape&Reel

ABSOLUTE MAXIMUM RATINGS ($T_A = 25^\circ\text{C}$ UNLESS OTHERWISE NOTED)					
Parameter	Symbol	5 secs	Steady State	Unit	
Drain-Source Voltage	V_{DS}	20		V	
Gate-Source Voltage	V_{GS}	± 6			
Continuous Drain Current ($T_J = 150^\circ\text{C}$) ^b	I_D	$T_A = 25^\circ\text{C}$	600	500	mA
		$T_A = 85^\circ\text{C}$	400	350	
Pulsed Drain Current ^a	I_{DM}	1000			
Continuous Source Current (diode conduction) ^b	I_S	275	250		
Maximum Power Dissipation	P_D	225		mW	
Operating Junction and Storage Temperature Range	T_J, T_{stg}	-55 to 150		$^\circ\text{C}$	
Gate-Source ESD Rating (HBM, Method 3015)	ESD	2000		V	

Notes

- d. Pulse width limited by maximum junction temperature.
e. Surface Mounted on FR4 Board.

LSI1012LT1G , S-LSI1012LT1G

SPECIFICATIONS (T _A = 25 °C UNLESS OTHERWISE NOTED)						
Parameter	Symbol	Test Condition	Min	Typ	Max	Unit
Static						
Gate Threshold Voltage	V _{GS(th)}	V _{DS} = V _{GS} , I _D = 250 μA	0.45		0.9	V
Gate-Body Leakage	I _{GSS}	V _{DS} = 0 V, V _{GS} = ±4.5 V		±0.5	±1.0	μA
Zero Gate Voltage Drain Current	I _{DSS}	V _{DS} = 20 V, V _{GS} = 0 V		0.3	100	nA
		V _{DS} = 20 V, V _{GS} = 0 V, T _J = 85 °C			5	μA
On-State Drain Current ^a	I _{D(on)}	V _{DS} = 5 V, V _{GS} = 4.5 V	700			mA
Drain-Source On-State Resistance ^a	r _{DS(on)}	V _{GS} = 4.5 V, I _D = 600 mA		0.41	0.70	Ω
		V _{GS} = 2.5 V, I _D = 500 mA		0.53	0.85	
		V _{GS} = 1.8 V, I _D = 350 mA		0.70	1.25	
Forward Transconductance ^a	g _{fs}	V _{DS} = 10 V, I _D = 400 mA		1.0		S
Diode Forward Voltage ^a	V _{SD}	I _S = 150 mA, V _{GS} = 0 V		0.8	1.2	V
Dynamic^b						
Total Gate Charge	Q _g	V _{DS} = 10 V, V _{GS} = 4.5 V, I _D = 250 mA		750		pC
Gate-Source Charge	Q _{gs}			75		
Gate-Drain Charge	Q _{gd}			225		
Turn-On Delay Time	t _{d(on)}	V _{DD} = 10 V, R _L = 47 Ω I _D ≅ 200 mA, V _{GEN} = 4.5 V, R _G = 10 Ω		5		ns
Rise Time	t _r			5		
Turn-Off Delay Time	t _{d(off)}			25		
Fall Time	t _f			11		

Notes

- a. Pulse test; pulse width ≤ 300 μs, duty cycle ≤ 2%.
- b. Guaranteed by design, not subject to production testing.

Stresses beyond those listed under "Absolute Maximum Ratings" may cause permanent damage to the device. These are stress ratings only, and functional operation of the device at these or any other conditions beyond those indicated in the operational sections of the specifications is not implied. Exposure to absolute maximum rating conditions for extended periods may affect device reliability.

LSI1012LT1G , S-LSI1012LT1G

TYPICAL CHARACTERISTICS (T_A = 25 °C UNLESS NOTED)

Output Characteristics

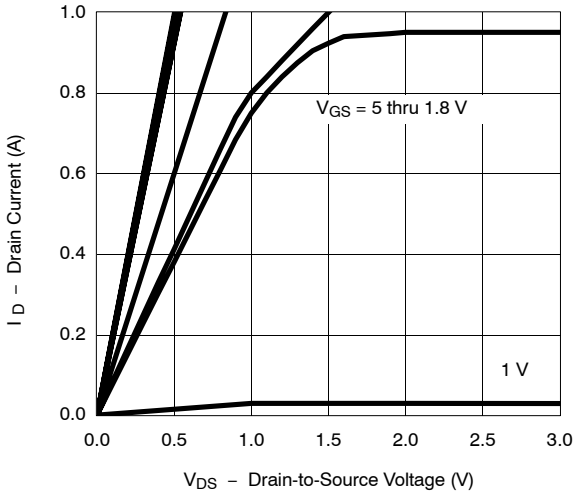

Transfer Characteristics

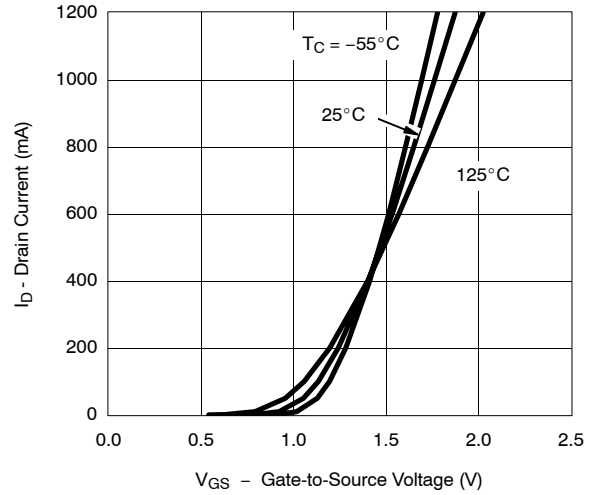

On-Resistance vs. Drain Current

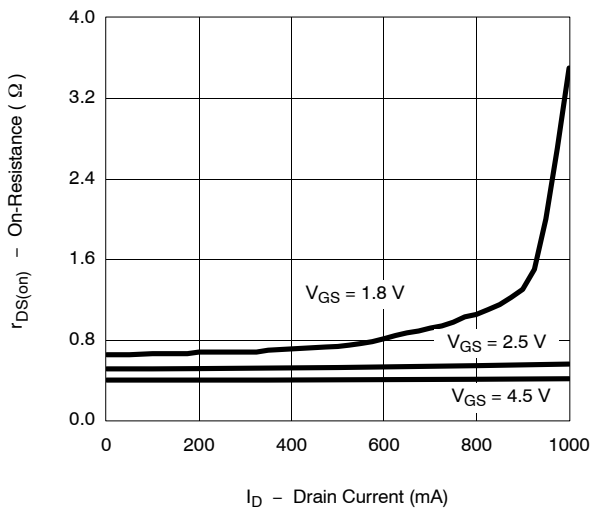

Capacitance

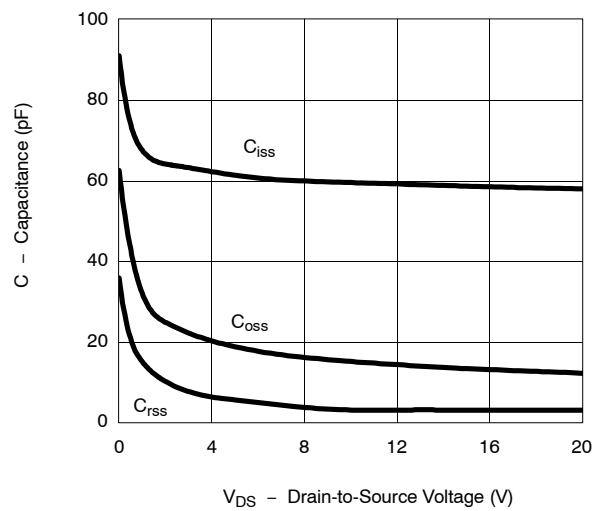

Gate Charge

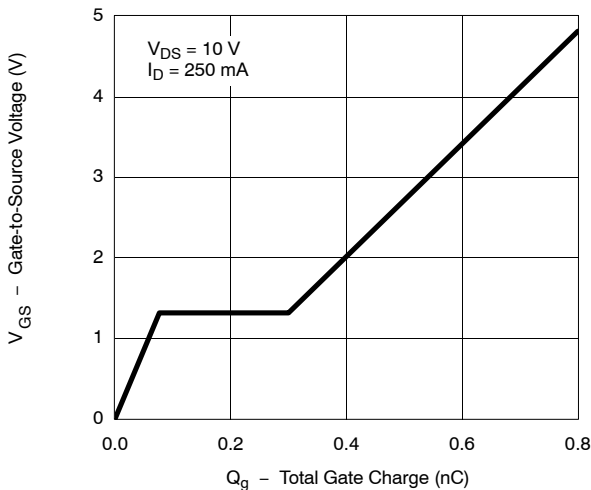

On-Resistance vs. Junction Temperature

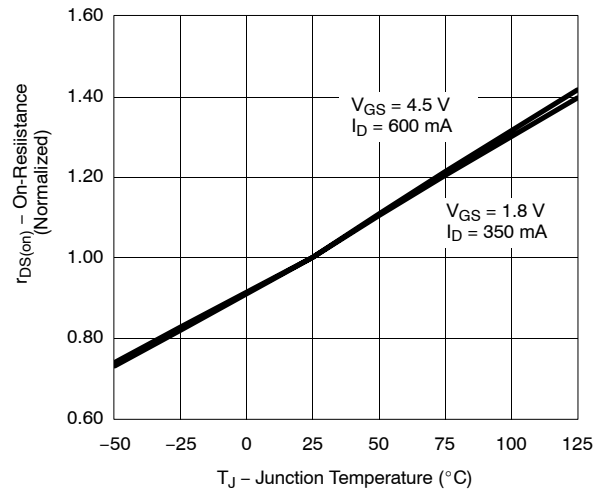

LSI1012LT1G , S-LSI1012LT1G

TYPICAL CHARACTERISTICS (T_A = 25 °C UNLESS NOTED)

Source-Drain Diode Forward Voltage

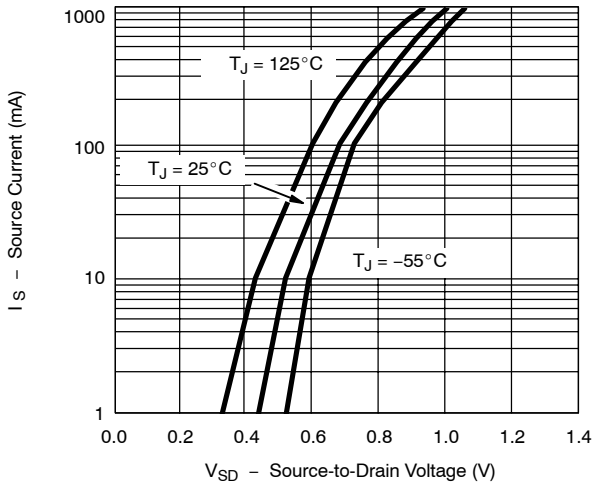

On-Resistance vs. Gate-to-Source Voltage

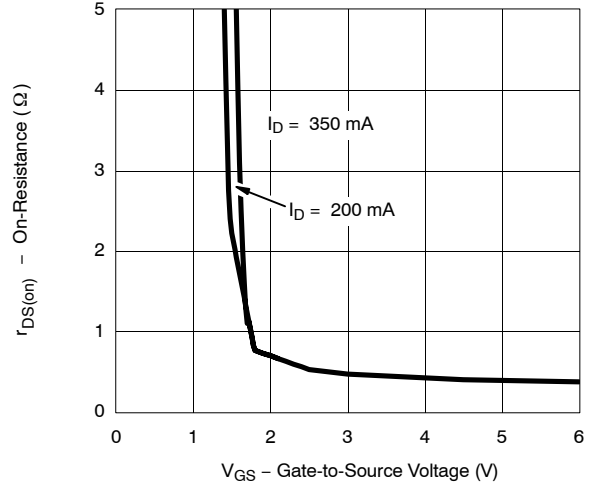

Threshold Voltage Variance vs. Temperature

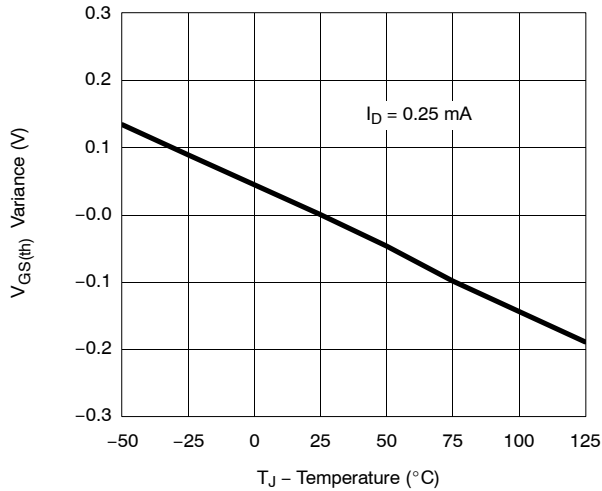

I_{GSS} vs. Temperature

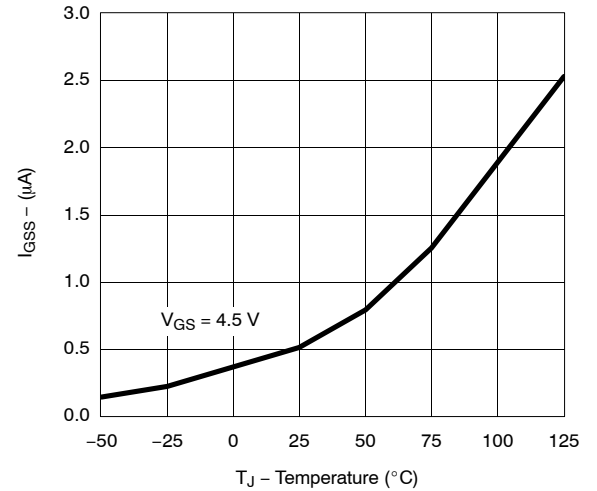

BV_{GSS} vs. Temperature

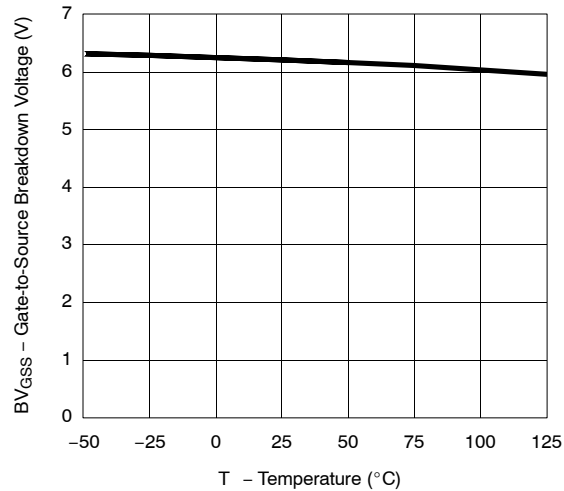

LSI1012LT1G , S-LSI1012LT1G

TYPICAL CHARACTERISTICS (T_A = 25 °C UNLESS NOTED)

Normalized Thermal Transient Impedance, Junction-to-Ambient (SC-75A)

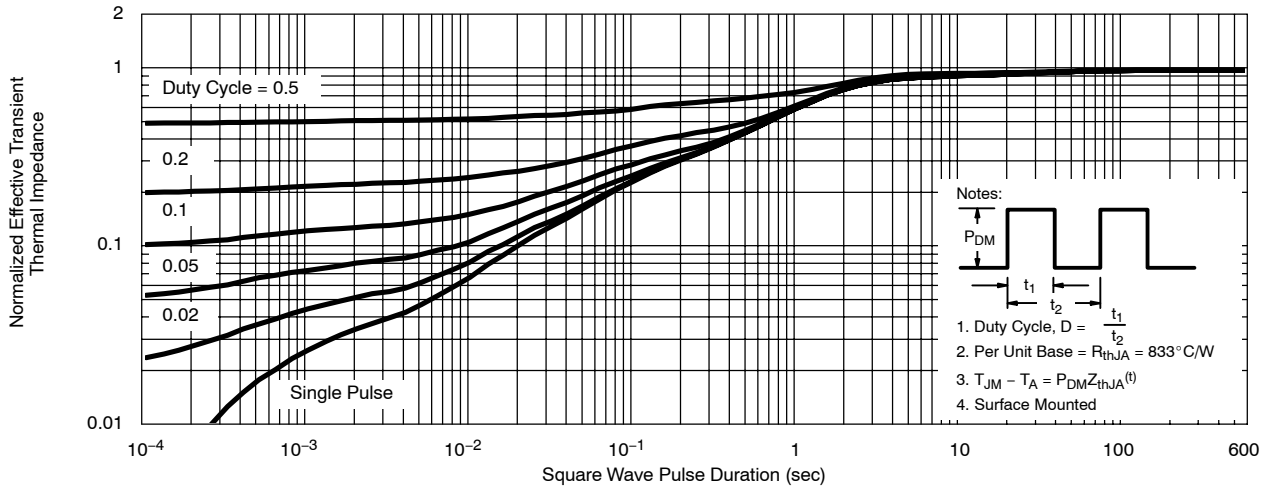

Normalized Thermal Transient Impedance, Junction-to-Foot

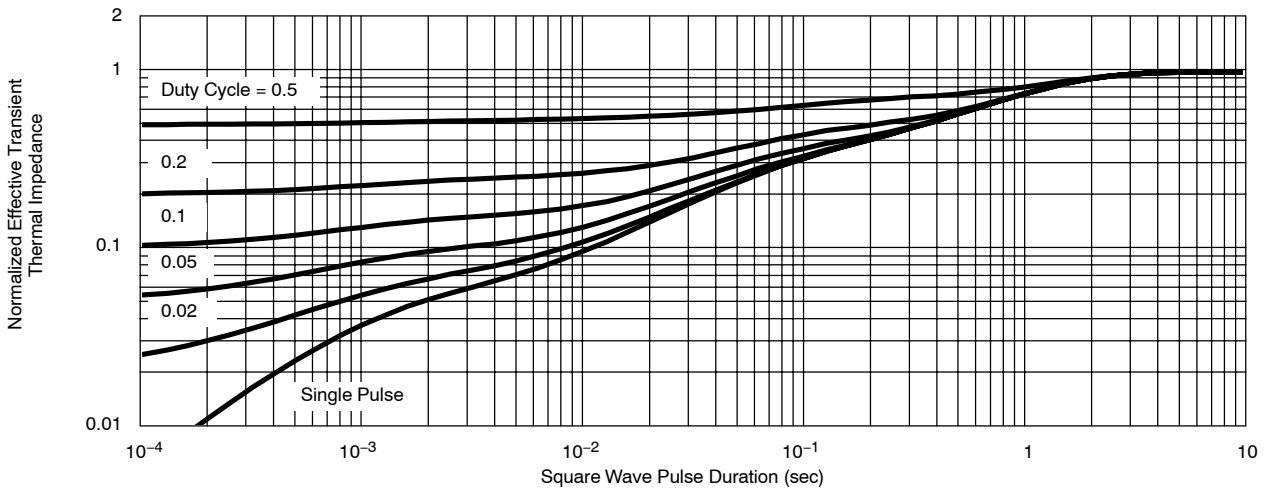

LSI1012LT1G , S-LSI1012LT1G

SOT-23

NOTES:

1. DIMENSIONING AND TOLERANCING PER ANSI Y14.5M,1982
2. CONTROLLING DIMENSION: INCH.

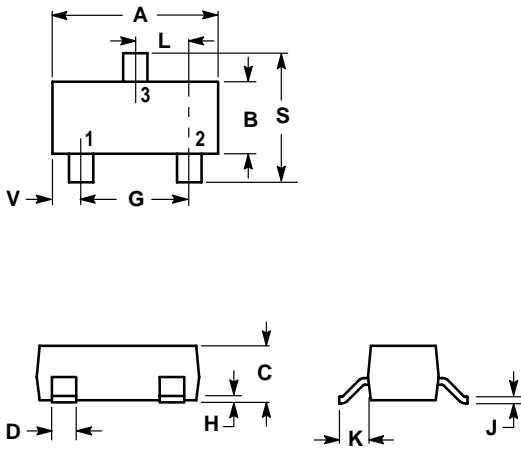

DIM	INCHES		MILLIMETERS	
	MIN	MAX	MIN	MAX
A	0.1102	0.1197	2.80	3.04
B	0.0472	0.0551	1.20	1.40
C	0.0350	0.0440	0.89	1.11
D	0.0150	0.0200	0.37	0.50
G	0.0701	0.0807	1.78	2.04
H	0.0005	0.0040	0.013	0.100
J	0.0034	0.0070	0.085	0.177
K	0.0140	0.0285	0.35	0.69
L	0.0350	0.0401	0.89	1.02
S	0.0830	0.1039	2.10	2.64
V	0.0177	0.0236	0.45	0.60

