

S13683-02WT

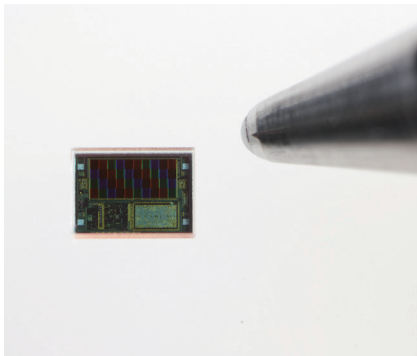

I²C compatible color sensor

The S13683-02WT is a color sensor that supports the inter-integrated circuit (I²C) interface. It is sensitive to red ($\lambda_p=615$ nm), green ($\lambda_p=530$ nm), blue ($\lambda_p=460$ nm), and infrared ($\lambda_p=855$ nm) light, and outputs detected results as 16-bit digital data for each color. The sensor automatically switches the photodiode of each color in order to perform measurements. The sensitivity and integration time are adjustable so that light measurements can be performed over a wide range. We provide an evaluation kit for this product. Contact us for detailed information.

Features

- I²C interface compatible
- Sequential measurements of red, green, blue, and infrared light
- 2-step sensitivity switching (sensitivity ratio 1:10)
- Adjustable sensitivity (1 to 65535 times) by setting the integration time
- Low voltage (2.5 V or 3.3 V) operation
- Low current consumption: 75 μ A typ.
- With infrared cutoff filter
- Wide dynamic range (low gain: 1 to 10 k \times)

Applications

- LCD backlight adjustment on cell phones, notebook PCs, etc.
- Energy-saving sensors on wide screen TV, etc.
- Various light level detection and chromaticity adjustment

Absolute maximum ratings (Ta=25 °C unless otherwise noted)

Parameter	Symbol	Condition	Value	Unit
Supply voltage	Vdd		-0.3 to +4.5	V
Output current	Io		± 10	mA
Power dissipation	P		100	mW
Operating temperature	Topr	No dew condensation*1	-40 to +85	°C
Storage temperature	Tstg	No dew condensation*1	-40 to +100	°C
Reflow soldering conditions*2	Tsol		Peak temperature: 260 °C, three times (see P.11)	

*1: When there is a temperature difference between a product and the surrounding area in high humidity environment, dew condensation may occur on the product surface. Dew condensation on the product may cause deterioration in characteristics and reliability.

*2: Moisture absorption and reflow conditions: JEDEC J-STD-020D LEVEL2a

Note: Exceeding the absolute maximum ratings even momentarily may cause a drop in product quality. Always be sure to use the product within the absolute maximum ratings.

Recommended operating conditions (Ta=25 °C unless otherwise noted)

Parameter	Symbol	Condition	Min.	Typ.	Max.	Unit
Supply voltage	Vdd		2.25	-	3.63	V
I ² C bus pull-up voltage*3	Vbus	Rp=2.2 kΩ	1.65	-	Vdd + 0.5	V
High level input voltage (SDA, SCL)*4	Vih	Vbus≥2.25 V Vdd>2.75 V	0.7Vbus	-	Vdd + 0.5	V
		Vbus<2.25 V Vdd≤2.75 V	0.8Vbus	-	Vdd + 0.5	V
Low level input voltage (SDA, SCL)*4	Vil	Vbus≥2.25 V Vdd>2.75 V	-0.5	-	0.2Vbus	V
		Vbus<2.25 V Vdd≤2.75 V	-0.5	-	0.3Vbus	V
Bus capacitance (SDA, SCL)	Cbus		-	-	400	pF

*3: For details, see the I²C specifications, "The I²C-BUS SPECIFICATION VERSION 2.1".

*4: Vdd - Vbus<1.2 V

Operation is not guaranteed if this condition is not met.

Electrical and optical characteristics

- Sensor section [Ta=25 °C, Vdd=Vbus=3.3 V, light source A (initial setting: low gain, integration time: 546 ms/ch), unless otherwise noted]

Parameter	Symbol	Condition	Min.	Typ.	Max.	Unit		
Spectral response range*5	λ	Blue		400 to 540		nm		
		Green		455 to 630				
		Red		575 to 660				
		Infrared, 700 nm or more		785 to 885				
Peak sensitivity wavelength	λp	Blue	-	460	-	nm		
		Green	-	530	-			
		Red	-	615	-			
		Infrared, 700 nm or more	-	855	-			
Current consumption	Operation mode	Idd	E=0 lx (dark state), excluding output current	30	75	150	μA	
	Standby mode	Idds		0.1	1.0	3.0		
Dark count	Sd	E=0 lx (dark state), initial setting	-	-	5	counts		
Gain ratio	rg	High gain/Low gain	-	10	-	-		
Photosensitivity	Low gain	Sbl	Blue	Initial setting	2.01	3.35	4.69	counts/lx
		Sgl	Green		4.57	7.61	10.66	
		Srl	Red		5.69	9.48	13.28	
		Sirl	Infrared		-	1.66	-	
		Sbl	Blue	Initial setting*6	2.51	3.35	4.19	
		Sgl	Green		5.71	7.61	9.52	
		Srl	Red		7.11	9.48	11.85	
		Sirl	Infrared		-	1.66	-	
Red/Blue sensitivity ratio	Low gain	Srl/Sbl	Initial setting Same chip	2.12	2.83	3.54	-	
Red/Green sensitivity ratio		Srl/Sgl		0.93	1.25	1.56		
Blue/Green sensitivity ratio		Sbl/Sgl		0.33	0.44	0.55		
Photosensitivity	High gain	Sbh	Blue	Integration time: 546 ms/ch	19.0	31.7	44.4	counts/lx
		Sgh	Green		45.7	76.2	106.7	
		Srh	Red		56.7	94.5	132.4	
		Sirh	Infrared		-	15.3	-	
		Sbh	Blue	Integration time: 546 ms/ch*6	23.8	31.7	39.7	
		Sgh	Green		57.2	76.2	95.3	
		Srh	Red		70.9	94.5	118.2	
		Sirh	Infrared		-	15.3	-	
Red/Blue sensitivity ratio	High gain	Srh/Sbh	Integration time: 546 ms/ch Same chip	2.24	2.98	3.73	-	
Red/Green sensitivity ratio		Srh/Sgh		0.93	1.24	1.55		
Blue/Green sensitivity ratio		Sbh/Sgh		0.31	0.42	0.52		

*5: In the range of 10% from the peak

*6: When integration time is measured and corrected. See "Sensitivity variation correction method." The measurement accuracy of integration time is 0.36%.

- I²C section (Ta=25 °C, Vdd=Vbus=3.3 V, unless otherwise noted)

Parameter	Symbol	Condition	Min.	Typ.	Max.	Unit
I ² C address	ADDR	7-bit	0x2A (0101010)			-
I ² C clock frequency	fclk		1	-	400	kHz
SDA, SCL output voltage	High level	Voh	Rp=2.2 kΩ	0.7Vbus	-	V
	Low level	Vol	Rp=2.2 kΩ	0	0.4	V
I/O terminal capacitance	Ci		-	-	20	pF
SDA/SCL output fall time*7	tf	Rp=2.2 kΩ, Cp=400 pF	-	-	250	ns

Note: The I²C interface (SDA, SCL) timings conform to the "I²C-bus specification version 2.1".

*7: The SCL/SDA output rise time is determined by the time constant of Cbus × Rp.

Register map

Adrs	Function	bit								
		7	6	5	4	3	2	1	0	
00	Control	ADC reset 1: reset 0: operation start	Standby function 1: standby mode 0: operation mode	Standby function monitor	-	Gain selection 1: high gain 0: low gain	Integration mode 1: manual setting mode 0: fixed time mode	Integration time setting (00) 87.5 μs, (01) 1.4 ms (10) 22.4 ms, (11) 179.2 ms		
01	Manual timing register	Integration time manual setting register (high byte)								
02		Integration time manual setting register (low byte)								
03	Sensor's data register (Red)	Output data (red, high byte)								
04		Output data (red, low byte)								
05	Sensor's data register (green)	Output data (green, high byte)								
06		Output data (green, low byte)								
07	Sensor's data register (Blue)	Output data (blue, high byte)								
08		Output data (blue, low byte)								
09	Sensor's data register (Infrared)	Output data (infrared, high byte)								
0A		Output data (infrared, low byte)								

Adrs 00 bit 7: Set this bit to 1 to reset the ADC section. This does not reset the register data. Set this bit to 0 to start operation.

Adrs 00 bit 6: Set this bit to 1 to switch to standby mode. The ADC section will stop its operation. This does not reset the register data.

Adrs 00 bit 5: This bit is used to monitor the auto standby function. When set to 1, the sensor is in standby mode. This bit is read-only.

Adrs 00 bit 3: Set this bit to 1 for high gain and 0 for low gain. The area ratio of the photodiodes used for high gain and low gain is 10:1. As such, the gain ratio is 10.

Adrs 00 bit 2: Set this bit to 1 to switch to manual setting mode and 0 to switch to fixed time mode. In manual setting mode, the sensor automatically switches to standby mode after a measurement is made. In fixed time mode, measurements are repeated continuously.

Adrs 00 bit 1,0: Select the integration time per color for fixed time mode. "00" is 87.5 μs, "01" is 1.4 ms, "10" is 22.4 ms, and "11" is 179.2 ms. In manual setting mode, the reference is twice this time, so "00" is 175 μs, "01" is 2.8 ms, "10" is 44.8 ms, and "11" is 358.4 ms. You can set an integer multiple of this value.

Adrs 01 & 02: Integer multiple time setting valid only in manual setting mode. You can set a value between 0x0000 (minimum) and 0xFFFF (65535, maximum). Set how many times to make the integration time set with the integration time setting (Tint) longer. For example, if you want to set the integration time per color to 546 ms, set Tint to "00" to select 175 μs, and set this register to N=3120 (0xC30).

Adrs 03 to 0A: The sensor measurement results are stored in these registers. These values are retained until the next measurement.

Initial setting [low gain, manual setting mode, Tint=00 (175 μs), integration time: 546 ms/ch]

This product has a built-in power-on reset function. After about 3 ms of delay time after the power is turned on, the registers are set to the default values shown in the following table.

Adrs	Function	bit								Hex
		7	6	5	4	3	2	1	0	
00	Control	1	1	1	-	0	1	0	0	0xE4
01	Manual timing register	0	0	0	0	1	1	0	0	0x0C
02		0	0	1	1	0	0	0	0	0x30

Integration time setting

Mode	Manual timing register (Adrs 01 & 02)	Integration time setting (Tint)			
		00	01	10	11
Fixed time mode	Invalid	87.5 μ s	1.4 ms	22.4 ms	179.2 ms
Manual setting mode	N	175 \times N μ s	2.8 \times N ms	44.8 \times N ms	358.4 \times N ms

Program example

Condition 1: Initial setting [manual setting mode, low gain, Tint=00 (175 μ s), manual timing=3120 (0x0C30), integration time: 546 ms/ch]

Command

Action		Data body								Ack	Remark
Address call (0x2A)	S	0	1	0	1	0	1	0	W	A	7-bit address
Register call (0x00)		0	0	0	0	0	0	0	0	A	Specifies the control byte
Register write (0x84)		1	0	0	0	0	1	0	0	A	ADC reset, standby release
Address call (0x2A)	Sr	0	1	0	1	0	1	0	W	A	Restart, address
Register call (0x00)		0	0	0	0	0	0	0	0	A	Specifies the control byte
Register write (0x04)		0	0	0	0	0	1	0	0	A	P ADC reset release, bus release
Stands by for longer than the integration time (>2184 ms)											
Address call (0x2A)	S	0	1	0	1	0	1	0	W	A	7-bit address
Register call (0x03)		0	0	0	0	0	0	1	1	A	Specifies the output data byte
Address call (0x2A)	Sr	0	1	0	1	0	1	0	R	A	Changes to read mode
Data read out (R: high byte)		X	X	X	X	X	X	X	X	A	Red data output
Data read out (R: low byte)		X	X	X	X	X	X	X	X	A	
Data read out (G: high byte)		X	X	X	X	X	X	X	X	A	Green data output
Data read out (G: low byte)		X	X	X	X	X	X	X	X	A	
Data read out (B: high byte)		X	X	X	X	X	X	X	X	A	Blue data output
Data read out (B: low byte)		X	X	X	X	X	X	X	X	A	
Data read out (infrared: high byte)		X	X	X	X	X	X	X	X	A	Infrared data output
Data read out (infrared: low byte)		X	X	X	X	X	X	X	X	\bar{A} P	

S=Start condition, Sr=Restart condition, A=Acknowledge, A=Acknowledge by host, P=Stop condition, R=Read mode (1), W=Write mode (0), \bar{A} =not acknowledge

Format

The same as the above command list

S	0x2A (7-bit)	W	A	0x00	A	0x84	A
---	--------------	---	---	------	---	------	---

Sr	0x2A (7-bit)	W	A	0x00	A	0x04	A	P
----	--------------	---	---	------	---	------	---	---

When the SCL clock is 400 kHz, the write time is 135 μ s.

Standby

S	0x2A (7-bit)	W	A	0x03	A	Sr	0x2A (7-bit)	R	A
---	--------------	---	---	------	---	----	--------------	---	---

Sensor data	A	Sensor data	A
-------------	---	-------------	---

Sensor data	A	Sensor data	A
-------------	---	-------------	---

Sensor data	A	Sensor data	A
-------------	---	-------------	---

Sensor data	A	Sensor data	\bar{A}	P
-------------	---	-------------	-----------	---

The readout time is 247.5 μ s.

from master to slave from slave to master

KPIC0326EA

Condition 2 [fixed time mode, high gain, Tint=01 (1.4 ms), integration time: 1.4 ms/ch]

■ Command

Action		Data body								Ack	Remark
Address call (0x2A)	S	0	1	0	1	0	1	0	W	A	7-bit address
Register call (0x00)		0	0	0	0	0	0	0	0	A	Specifies the control byte
Register write (0x89)		1	0	0	0	1	0	0	1	A	ADC reset, standby release
Address call (0x2A)	Sr	0	1	0	1	0	1	0	W	A	7-bit address
Register call (0x00)		0	0	0	0	0	0	0	0	A	Specifies the control byte
Register write (0x09)		0	0	0	0	1	0	0	1	A	P ADC reset release, bus release
Stands by for longer than the integration time. Measurement is performed during standby. (> 5.6 ms) Measurements are repeated continuously.											
Address call (0x2A)	S	0	1	0	1	0	1	0	W	A	7-bit address
Register call (0x03)		0	0	0	0	0	0	1	1	A	Specifies the output data byte
Address call (0x2A)	Sr	0	1	0	1	0	1	0	R	A	Changes to read mode
Data read out (R: high byte)		X	X	X	X	X	X	X	X	A	Red data output
Data read out (R: low byte)		X	X	X	X	X	X	X	X	A	
Data read out (G: high byte)		X	X	X	X	X	X	X	X	A	Green data output
Data read out (G: low byte)		X	X	X	X	X	X	X	X	A	
Data read out (B: high byte)		X	X	X	X	X	X	X	X	A	Blue data output
Data read out (B: low byte)		X	X	X	X	X	X	X	X	A	
Data read out (infrared: high byte)		X	X	X	X	X	X	X	X	A	Infrared data output
Data read out (infrared: low byte)		X	X	X	X	X	X	X	X	\bar{A} P	

S=Start condition, Sr=Restart condition, A=Acknowledge, A=Acknowledge by host, P=Stop condition, R=Read mode(1), W=Write mode(0), \bar{A} =not acknowledge

■ Format

The same as the above command list

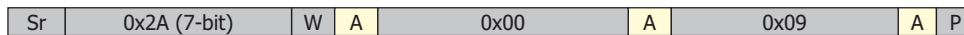
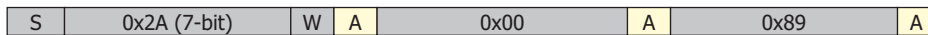

When the SCL clock is 400 kHz, the write time is 135 μs.

Standby

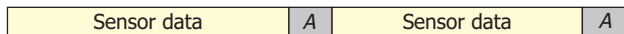
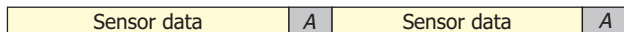
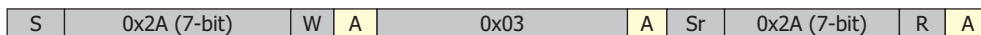

The readout time is 247.5 μs.

from master to slave from slave to master

KPIC0327EA

Condition 3 [manual setting mode, high gain, Tint=01 (2.8 ms), manual timing=357 (0x165), integration time: 1.0 s/ch]

■ Command

Action		Data body								Ack	Remark	
Address call (0x2A)	S	0	1	0	1	0	1	0	0	W	A	7-bit address
Register call (0x00)		0	0	0	0	0	0	0	0	0	A	Specifies the control byte
Register write (0x8D)		1	0	0	0	1	1	0	1	1	A	ADC reset, standby release
Register write (0x01)		0	0	0	0	0	0	0	1	1	A	Manual timing high byte
Register write (0x65)		0	1	1	0	0	1	0	1	1	A	Manual timing low byte
Address call (0x2A)	Sr	0	1	0	1	0	1	0	0	W	A	7-bit address
Register call (0x00)		0	0	0	0	0	0	0	0	0	A	Specifies the control byte
Register write (0x0D)		0	0	0	0	1	1	0	1	1	A	P ADC reset release, bus release
Stands by for longer than the integration time. Measurement is performed during standby. (> 4.0 s) Measurements are repeated continuously.												
Address call (0x2A)	S	0	1	0	1	0	1	0	0	W	A	7-bit address
Register call (0x03)		0	0	0	0	0	0	1	1	1	A	Specifies the sensor data byte
Address call (0x2A)	Sr	0	1	0	1	0	1	0	0	R	A	Changes to read mode
Data read out (R: high byte)		X	X	X	X	X	X	X	X	X	A	Red data output
Data read out (R: low byte)		X	X	X	X	X	X	X	X	X	A	
Data read out (G: high byte)		X	X	X	X	X	X	X	X	X	A	Green data output
Data read out (G: low byte)		X	X	X	X	X	X	X	X	X	A	
Data read out (B: high byte)		X	X	X	X	X	X	X	X	X	A	Blue data output
Data read out (B: low byte)		X	X	X	X	X	X	X	X	X	A	
Data read out (infrared: high byte)		X	X	X	X	X	X	X	X	X	A	Infrared data output
Data read out (infrared: low byte)		X	X	X	X	X	X	X	X	\bar{A}	P	

S=Start condition, Sr=Restart condition, A=Acknowledge, A=Acknowledge by host, P=Stop condition, R=Read mode(1), W=Write mode(0), \bar{A} =not acknowledge

■ Format

The same as the above command list

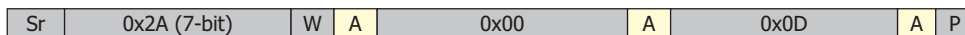
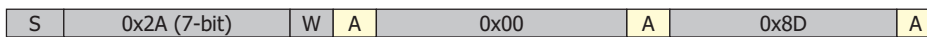

When the SCL clock is 400 kHz, the write time is 180 μs.

Standby

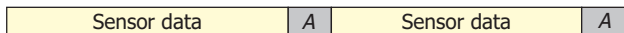
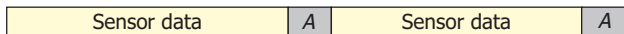
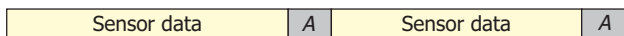
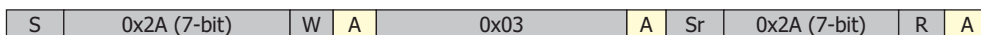

The readout time is 247.5 μs.

from master to slave from slave to master

KPIC0328EA

Sensitivity variation correction method

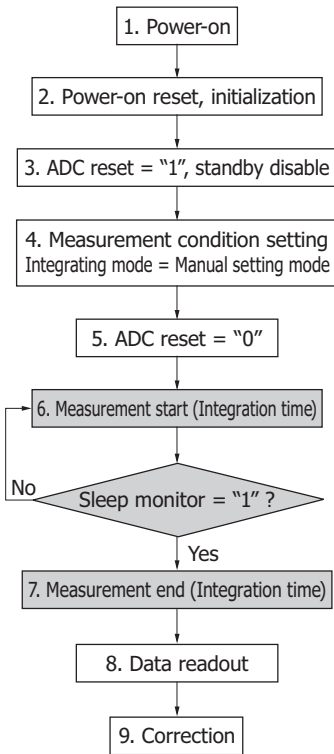

Sensitivity variation can be decreased using the correction coefficient which is calculated from the integration time measurement result.

■ Integration time measurement

In case of integration time measurement, it is necessary to set manual setting mode. Set ADC reset to "0" to start measuring the integration time on the microcontroller side. Integration time T_{meas} can be measured by checking Sleep monitor (Adrs00 bit5)="1."

■ Correction method

The correction coefficient and the sensitivity after correction are expressed with the following equation.

$$K = \frac{T_{set}}{T_{meas}}$$

$$S' = S \cdot K$$

- K : correction coefficient
- T_{set} : integration time (setting)
- T_{meas} : integration time (measurement)
- S : Photosensitivity (measurement)
- S' : Photosensitivity (correction)

Sensitivity variation can be reduced by using correction coefficient K.

■ Measurement accuracy of integration time

Loop delay time (T_{unit}) is the minimum T_{meas} resolution. If T_{unit} is set to 7.8 ms, the integration time (T_{set}) under the initial setting becomes 546 ms × 4 = 2184 ms, so the integration time measurement accuracy is expressed with the following equation.

$$\frac{T_{unit}}{T_{set}} \times 100 = \frac{7.8}{2184} \times 100 = 0.36\%$$

Spectral response (typical example)

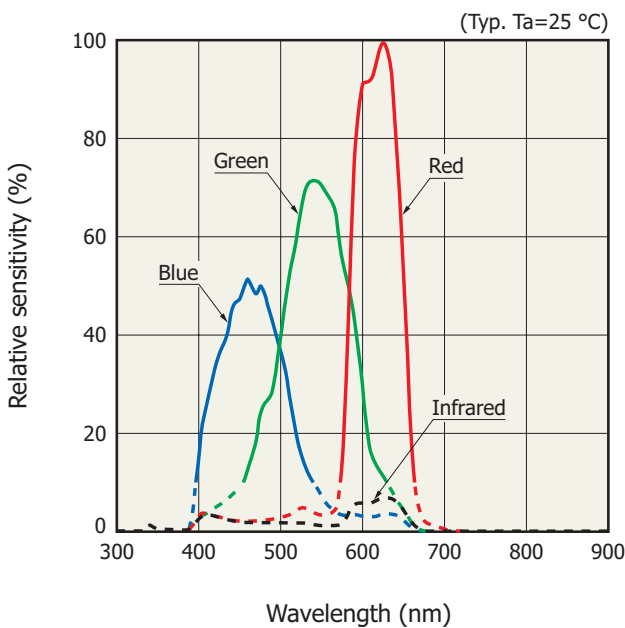

Count value vs. illuminance (typical example)

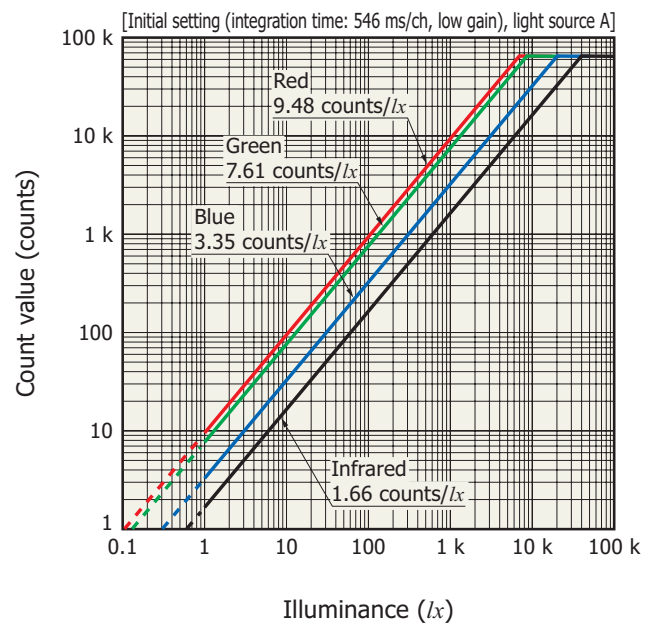

Block diagram

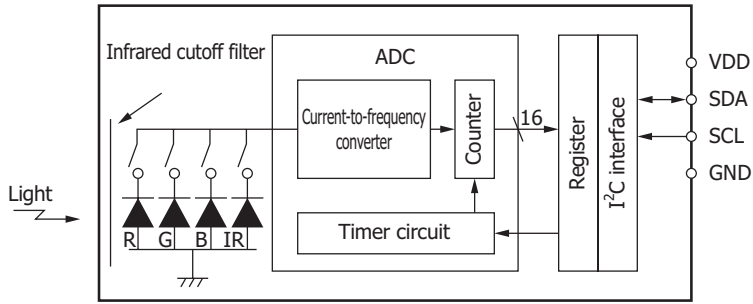

KPIC0316EA

Timing chart of standby function

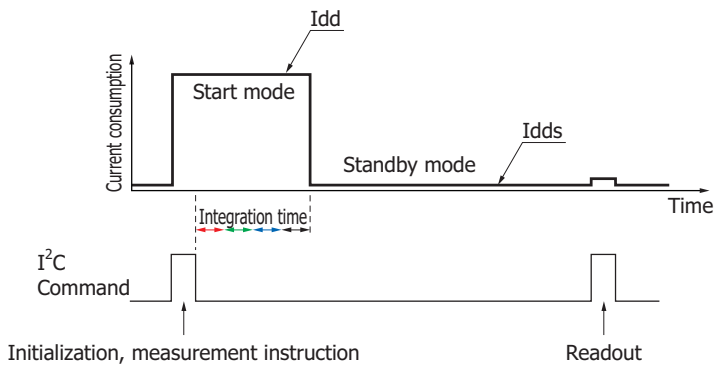

KPIC0158EA

Connection example

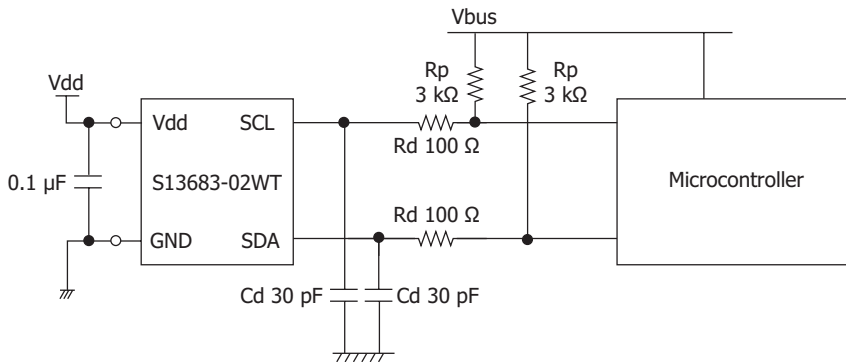

KPIC0315EA

Dimensional outline (unit: mm)

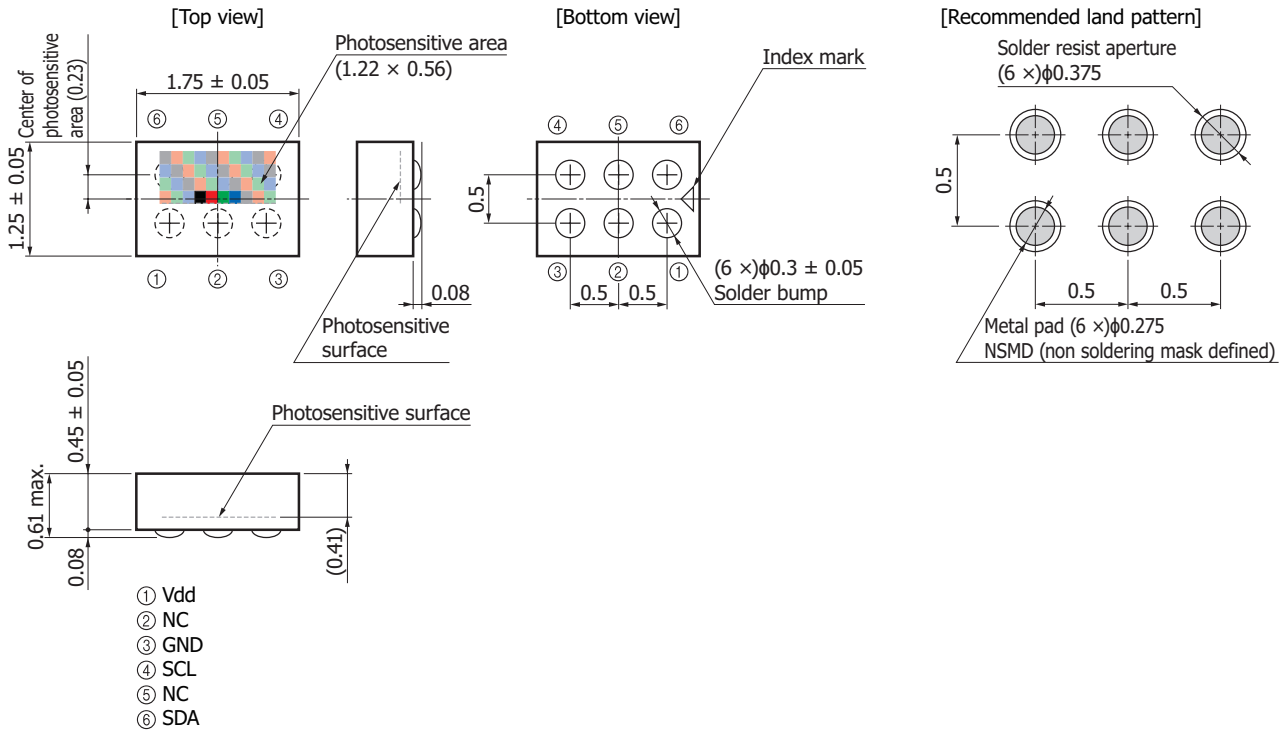

Tolerance unless otherwise noted: ±0.05
Solder bump material: Sn (96.5%), Ag (3%), Cu (0.5%)

KPIC0107EA

Enlarged view of photosensitive area (unit: μm)

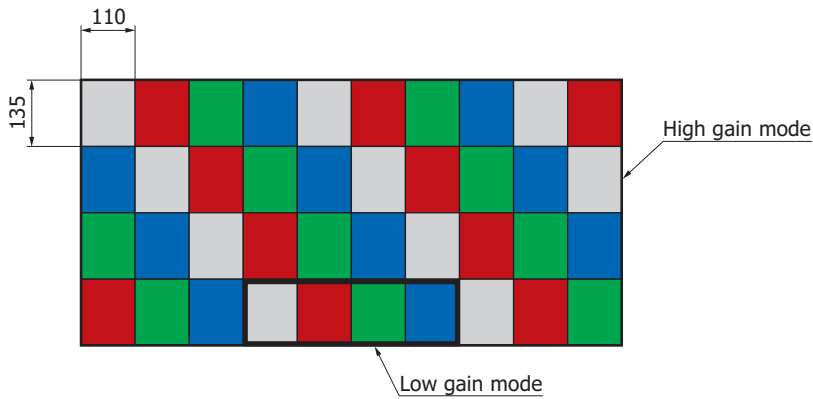

KPIC00153EA

Standard packing specifications

■ Reel (conforms to JEITA ET-7200)

Dimension	Hub diameter	Tape width	Material	Electrostatic characteristics
180 mm	60 mm	8 mm	PS	-

■ Embossed tape (unit: mm, material: PS, conductive)

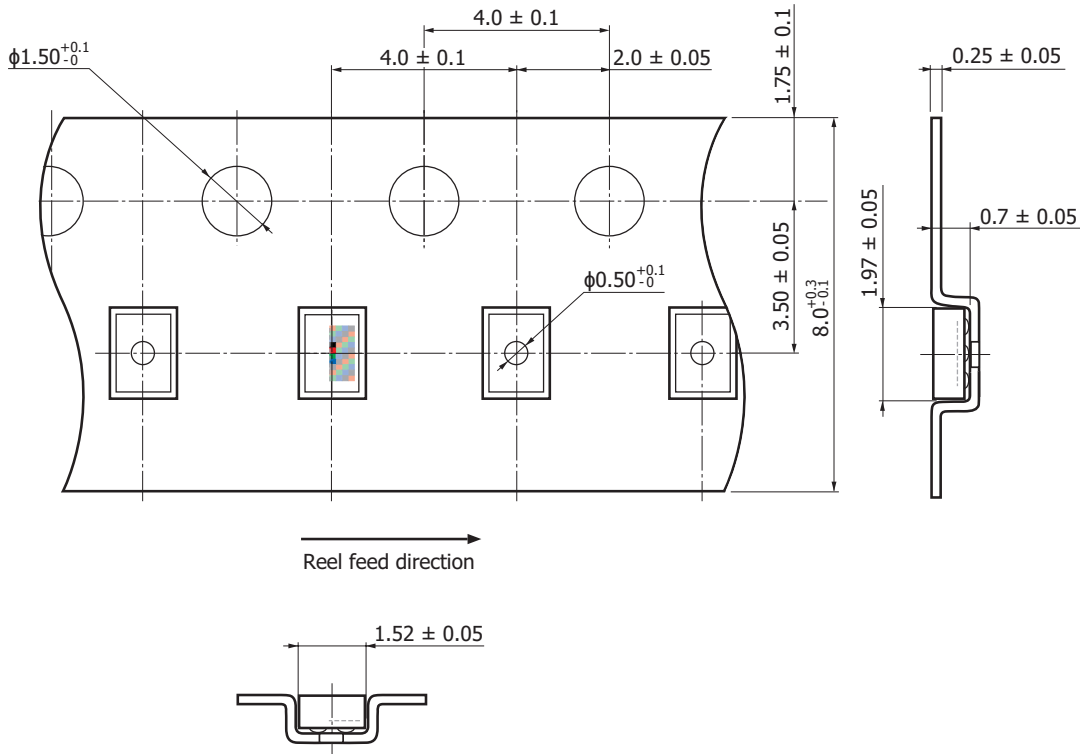

KPIC0317EA

■ Packing quantity
3000 pcs/reel

■ Packing type
Reel and desiccant in moisture-proof packaging (vacuum-sealed)

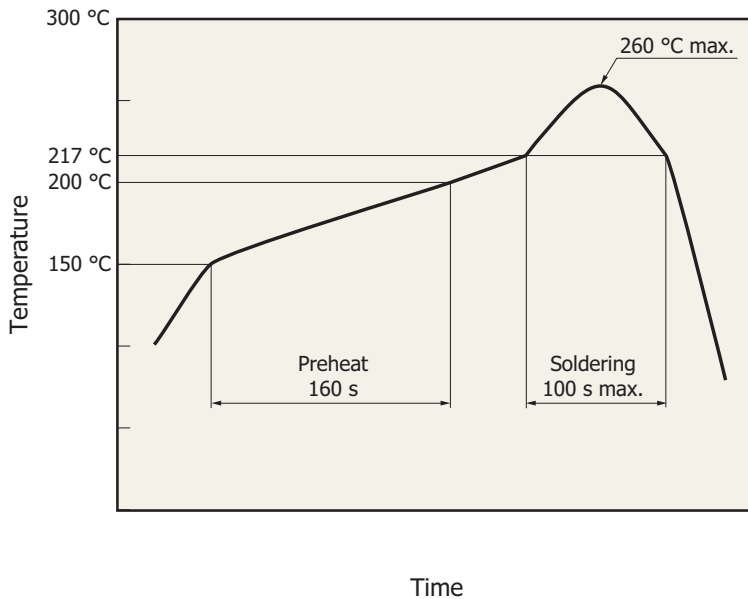
Measured example of temperature profile with our hot-air reflow oven for product testing

KPICB0168EB

- This product supports lead-free soldering. After unpacking, store it in an environment at a temperature of 30 °C or less and a humidity of 60% or less, and perform soldering within a month.
- The effect that the product receives during reflow soldering varies depending on the circuit board and reflow oven that are used. When you set reflow soldering conditions, check that problems do not occur in the product by testing out the conditions in advance.

Related information

www.hamamatsu.com/sp/ssd/doc_en.html







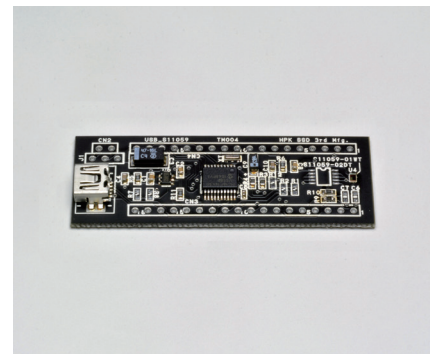







- Precautions
 - Disclaimer
 - Metal, ceramic, plastic packages
 - Surface mount type products

Evaluation kit for color sensor (S13683-02WT)

An evaluation kit [60 mm (H) × 21.5 mm (V)] for understanding the operating principle of Hamamatsu's S13683-02WT color sensor is available. Contact us for detailed information.

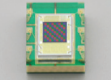

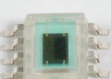
RGB color sensor lineup

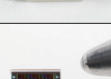
Type no.	Type	Photosensitive area (mm)	Package (mm)	Peak sensitivity wavelength (nm)	Photosensitivity				Photo						
S9032-02	Photodiode	 $\phi 2.0$	4 × 4.8 × 1.8 ^t 6 pin (Filter 0.75 ^t)	B 460	B	0.18 (A/W) [$\lambda=460$ nm]									
				G 540	G	0.23 (A/W) [$\lambda=540$ nm]									
				R 620	R	0.16 (A/W) [$\lambda=620$ nm]									
S9702	Photodiode	 1.0 × 1.0	3 × 4 × 1.3 ^t 4 pin (Filter 0.75 ^t)	B 460	B	0.18 (A/W) [$\lambda=460$ nm]									
				G 540	G	0.23 (A/W) [$\lambda=540$ nm]									
				R 620	R	0.16 (A/W) [$\lambda=620$ nm]									
S10917-35GT	Photodiode	 1.0 × 1.0	3 × 1.6 × 1.0 ^t COB (On-chip filter)	B 460	B	0.2 (A/W) [$\lambda=460$ nm]									
				G 540	G	0.23 (A/W) [$\lambda=540$ nm]									
				R 620	R	0.17 (A/W) [$\lambda=620$ nm]									
S10942-01CT	Photodiode	 1.0 × 1.0	3 × 1.6 × 1.0 ^t COB (On-chip filter)	*	B	0.21 (A/W) [$\lambda=460$ nm]									
					G	0.25 (A/W) [$\lambda=540$ nm]									
					R	0.45 (A/W) [$\lambda=640$ nm]									
S9706	Digital photo IC	 1.2 × 1.2	4 × 4.8 × 1.8 ^t 6 pin (Filter 0.75 ^t)	B 465	Low	B	0.21 (LSB/lx)	High	B	1.9 (LSB/lx)					
				G 540								G	0.45 (LSB/lx)	G	4.1 (LSB/lx)
				R 615								R	0.64 (LSB/lx)	R	5.8 (LSB/lx)
S11012-01CR	Digital photo IC	 1.2 × 1.2	3.43 × 3.8 × 1.6 ^t COB (On-chip filter)	*	Low	B	0.3 (LSB/lx)	High	B	2.6 (LSB/lx)					
												G	0.6 (LSB/lx)	G	5.3 (LSB/lx)
												R	1.4 (LSB/lx)	R	12.9 (LSB/lx)
S11059-02DT /-03DS	I ² C compatible color sensor	 0.56 × 1.22	3 × 4.2 × 1.3 ^t 10 pin (on-chip filter)	B 460	Low	B	4.4 (count/lx)	High	B	44.8 (count/lx)					
				G 530								G	8.3 (count/lx)	G	85.0 (count/lx)
				R 615								R	11.2 (count/lx)	R	117.0 (count/lx)
				IR 855								IR	3.0 (count/lx)	IR	30.0 (count/lx)
S13683-02WT	I ² C compatible color sensor	 1.22 × 0.56	1.75 × 1.25 × 0.48 ^t WL-CSP (on-chip filter)	R 615	Low	R	9.48 (count/lx)	High	R	94.5 (count/lx)					
				G 530								G	7.61 (count/lx)	G	76.2 (count/lx)
				B 460								B	3.35 (count/lx)	B	31.7 (count/lx)
				IR 855								IR	1.66 (count/lx)	IR	15.3 (count/lx)

* Refer to the spectral response of each product's datasheet.

The content of this document is current as of September 2018.

Product specifications are subject to change without prior notice due to improvements or other reasons. This document has been carefully prepared and the information contained is believed to be accurate. In rare cases, however, there may be inaccuracies such as text errors. Before using these products, always contact us for the delivery specification sheet to check the latest specifications.

The product warranty is valid for one year after delivery and is limited to product repair or replacement for defects discovered and reported to us within that one year period. However, even if within the warranty period we accept absolutely no liability for any loss caused by natural disasters or improper product use. Copying or reprinting the contents described in this material in whole or in part is prohibited without our prior permission.

HAMAMATSU

www.hamamatsu.com

HAMAMATSU PHOTONICS K.K., Solid State Division

1126-1 Ichino-cho, Higashi-ku, Hamamatsu City, 435-8558 Japan, Telephone: (81) 53-434-3311, Fax: (81) 53-434-5184

U.S.A.: Hamamatsu Corporation, 360 Foothill Road, Bridgewater, N.J. 08807, U.S.A., Telephone: (1) 908-231-0960, Fax: (1) 908-231-1218, E-mail: usa@hamamatsu.com

Germany: Hamamatsu Photonics Deutschland GmbH: Arzbergerstr. 10, D-82211 Herrsching am Ammersee, Germany, Telephone: (49) 8152-375-0, Fax: (49) 8152-265-8, E-mail: info@hamamatsu.de

France: Hamamatsu Photonics France S.A.R.L.: 19, Rue du Saule Trapu, Parc du Moulin de Massy, 91882 Massy Cedex, France, Telephone: 33-(1) 69 53 71 00, Fax: 33-(1) 69 53 71 10, E-mail: info@hamamatsu.fr

United Kingdom: Hamamatsu Photonics UK Limited: 2 Howard Court, 10 Tewin Road, Welwyn Garden City, Hertfordshire AL7 1BW, United Kingdom, Telephone: (44) 1707-294888, Fax: (44) 1707-325777, E-mail: info@hamamatsu.co.uk

North Europe: Hamamatsu Photonics Norden AB: Torshamnsgatan 35 16440 Kista, Sweden, Telephone: (46)8-509 031 00, Fax: (46)8-509 031 01, E-mail: info@hamamatsu.se

Italy: Hamamatsu Photonics Italia S.r.l.: Strada della Moia, 1 int. 6, 20020 Arese (Milano), Italy, Telephone: (39)02-93 58 17 33, Fax: (39)02-93 58 17 41, E-mail: info@hamamatsu.it

China: Hamamatsu Photonics (China) Co., Ltd.: B1201, Jiaming Center, No.27 Dongsanhuan Beilu, Chaoyang District, Beijing 100020, China, Telephone: (86) 10-6586-6006, Fax: (86) 10-6586-2866, E-mail: hpc@hamamatsu.com.cn

Taiwan: Hamamatsu Photonics Taiwan Co., Ltd.: 8F-3, No. 158, Section2, Gongdao 5th Road, East District, Hsinchu, 300, Taiwan R.O.C. Telephone: (886)03-659-0080, Fax: (886)03-659-0081, E-mail: info@hamamatsu.com.tw