

| REV. | ECN. NO. | NAME | DATE |
|------|----------|------|------|
| | | | |
| | | | |

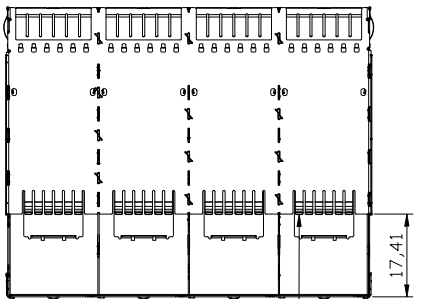

PART NUMBER SELECTION

| P/N | REAR LEGS OPTIONALS |
|------------------|---------------------|
| HT10-5014100-00S | 1 LEG PER PORT |
| HT10-5014000-00S | 0 LEG PER PORT |

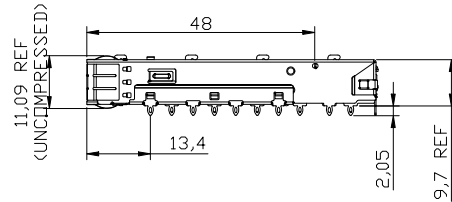
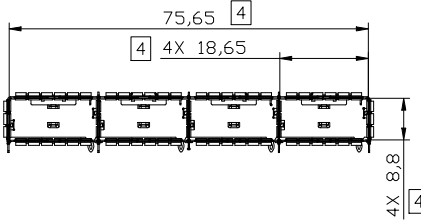
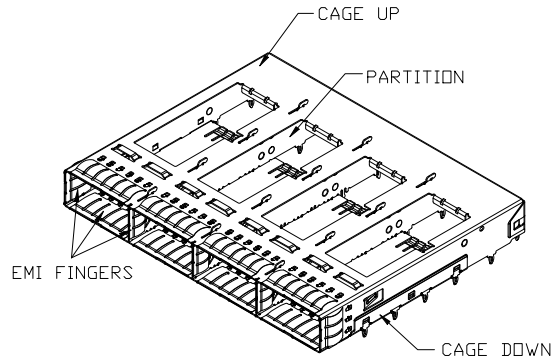
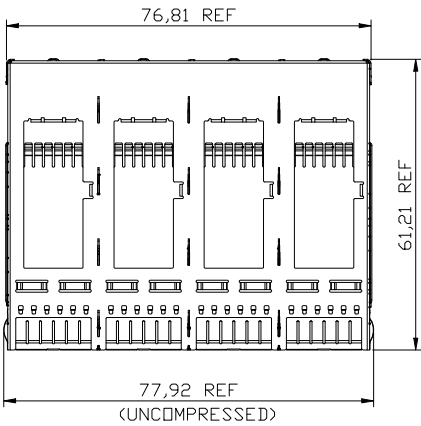
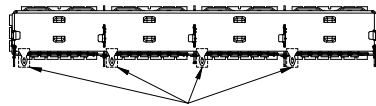

REAR LEGS ARE OPTIONAL:
1 LEG OR NO LEG

- MATERIALS:
CAGE UP: STAINLESS STEEL, 0,25 THICKNESS
CAGE DOWN: STAINLESS STEEL, 0,25 THICKNESS
PARTITION: STAINLESS STEEL
EMI FINGERS: STAINLESS STEEL
HEATSINK: ALUMINUM
HEATSINK CLIP: STAINLESS STEEL
LIGHT PIPE MATERIAL: CLEAR POLYCARBONATE
CAP: THERMOPLASTIC 94V-0,BLACK
- SURFACE FINISH:
BODY CAGE: CLEANING
EMI SPRING FINISH: CLEANING AND HOLE SEALING
HEATSINK FINISH: BLACK ANODIZED
HEATSINK CLIP FINISH: CLEANING
- MATE WITH QSFP MSA COMPATIBLE TRANSCEIVER.
- INSIDE SURFACE OF CASKET WHEN FULLY COMPRESSED.
- REFERENCE DOCUMENTS:
PRODUCT SPECIFICATION: SFF-8663
- THIS PRODUCT COMPLY TO ROHS DIRECTIVE 2011/65/EU.

S148 X X X 1 X
1 2 3 4

- REAR LEGS:
0=W/O REAR LEG
1=W/ 1 REAR LEG
- LIGHT PIPE & CAP OPTION:
0=W/O Light Pipe, W/O CAP
1=W/ Light Pipe, W/O CAP
2=W/ Light Pipe, W/ CAP
- LIGHT PIPE DIM "A" & PLATING OPTION:
0=W/O Light Pipe
1=DIM A=10.7mm, W/O Silver Color plating
2=DIM "A"=9.7mm, W/O Silver Color plating
3=DIM A=10.7mm, W/Silver Color plating
4=DIM "A"=9.7mm, W/Silver Color plating
- PROCESS OPTION:
0=W/O Heatsink, Open Top
1=W/PC(Heatsink 4.2mm)
2=W/SAN(Heatsink 6.5mm)
3=W/Networking(Heatsink 13.5mm)

REAR LEGS OPTIONALS

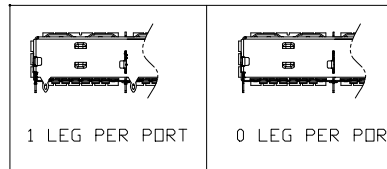

REMARK: APPLIES TO ALL CAGES IN THIS DRAWING

RoHS Compliant

| | | | | | |
|-----------------------|---------|--|-------------------------|---------------------------|--------------------------|
| TOLERANCE UNSPECIFIED | | VITALCON a vital connector company | | FOR YOUR VITAL CONNECTION | |
| .0 | ± 0.38 | | | TITLE: QSFP+28G 1X4 CAGE | |
| .00 | ± 0.25 | DRAWN BY: BECKER | PART NO: S148 X X X 1 X | REV: A | |
| .000 | ± 0.10 | CHECKED BY: VTA | SIZE: A4 | UNIT:mm | SHEET:10F7 |
| ANGLE | ± 3.00° | APPROVED BY: QPF | PROJECTION | | http://www.vitalconn.com |
| MANUFACTURING COPY | | | | | |

| REV. | ECN. NO. | NAME | DATE |
|------|----------|------|------|
| | | | |

WITH HEATSINK, WITH LIGHT PIPES
 LIGHT PIPE WITHOUT SILVER COLOR PLATING

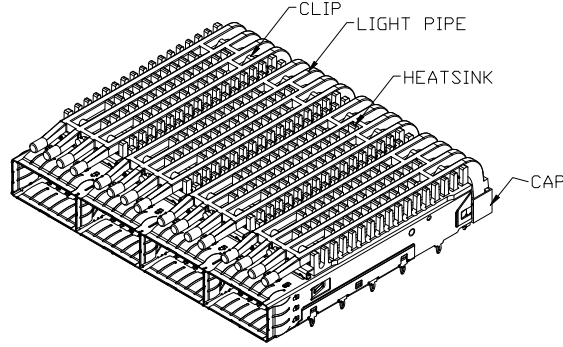
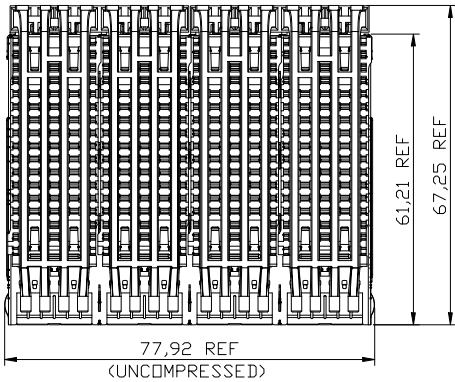

HEATSINK OPTIONALS

| OVERALL HEATSINK HEIGHT | DIM "H" | |
|-------------------------|--------------------------|-------------------------|
| | BEFORE MODULE INSTALLING | AFTER MODULE INSTALLING |
| PCI HS (4.2mm) | 12.8 | 13.7 |
| SAN HS (6.5mm) | 15.1 | 16.0 |
| NET HS (13.5mm) | 22.1 | 23.0 |

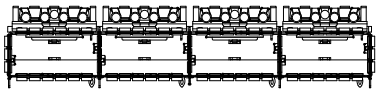
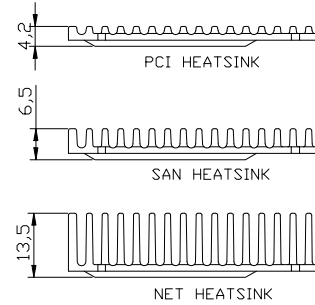

DIM "A" ±0.3
 FROM FIRST LEG TO LIGHT PIPE

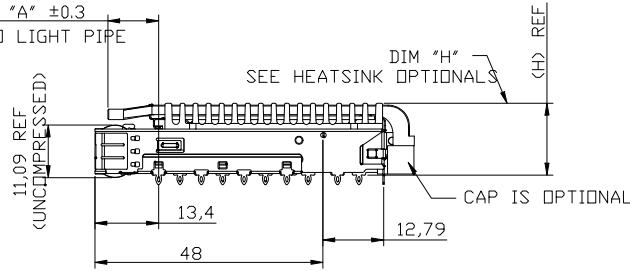

PART NUMBER SELECTION

| | | | |
|-------|-------------|---------------------|---------------|
| 10.7 | NET(13.5mm) | 1 | W/ CAP |
| 9.7 | NET(13.5mm) | 1 | W/ CAP |
| 10.7 | SAN(6.5mm) | 1 | W/ CAP |
| 9.7 | SAN(6.5mm) | 1 | W/ CAP |
| 10.7 | PCI(4.2mm) | 1 | W/ CAP |
| 9.7 | PCI(4.2mm) | 1 | W/ CAP |
| 10.7 | NET(13.5mm) | 0 | W/ CAP |
| 9.7 | NET(13.5mm) | 0 | W/ CAP |
| 10.7 | SAN(6.5mm) | 0 | W/ CAP |
| 9.7 | SAN(6.5mm) | 0 | W/ CAP |
| 10.7 | PCI(4.2mm) | 0 | W/ CAP |
| 9.7 | PCI(4.2mm) | 0 | W/ CAP |
| DIM A | HEAT SINK | REAR LEGS OPTIONALS | CAP OPTIONALS |

CAP OPTIONALS

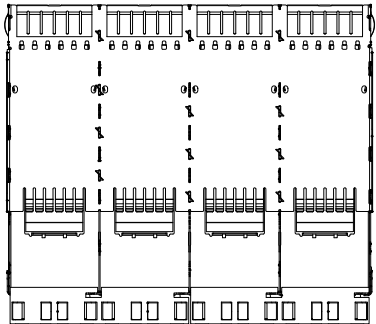
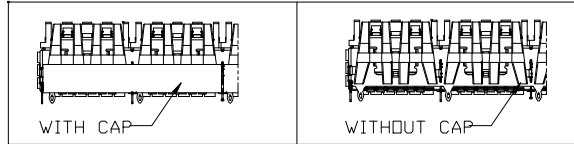

RoHS Compliant

| | | | | | |
|-----------------------|---------|--|--------|---|----------------|
| TOLERANCE UNSPECIFIED | | VITALCON a vital connector company | | FOR YOUR VITAL CONNECTION | |
| .0 | ± 0.38 | | | TITLE: QSFP+28G 1X4 CAGE | |
| .00 | ± 0.25 | DRAWN BY: | BECKER | PART NO: | S148 X X X 1 X |
| .000 | ± 0.10 | CHECKED BY: | VTA | SIZE: A4 | UNIT:mm |
| ANGLE | ± 3.00° | APPROVED BY: | QPF | PROJECTION | SHEET:20F7 |
| MANUFACTURING COPY | | | | REV: A | FCN: A4 |
| | | | | http://www.vitalconn.com | |

| REV. | ECN. NO. | NAME | DATE |
|------|----------|------|------|
| | | | |
| | | | |

WITH HEATSINK, WITH LIGHT PIPES
LIGHT PIPE WITH SILVER COLOR PLATING

HEATSINK OPTIONALS

| OVERALL HEATSINK HEIGHT | DIM "H" | |
|-------------------------|--------------------------|-------------------------|
| | BEFORE MODULE INSTALLING | AFTER MODULE INSTALLING |
| PCI HS (4.2mm) | 12.8 | 13.7 |
| SAN HS (6.5mm) | 15.1 | 16.0 |
| NET HS (13.5mm) | 22.1 | 23.0 |

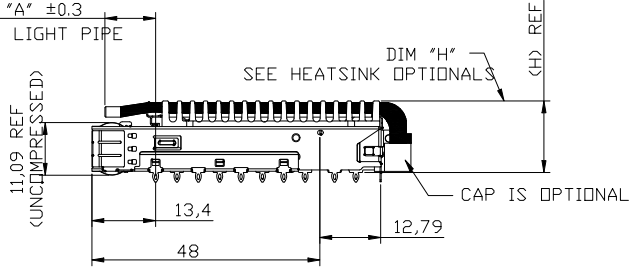
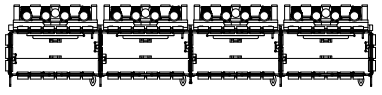
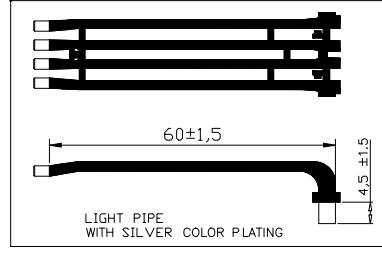
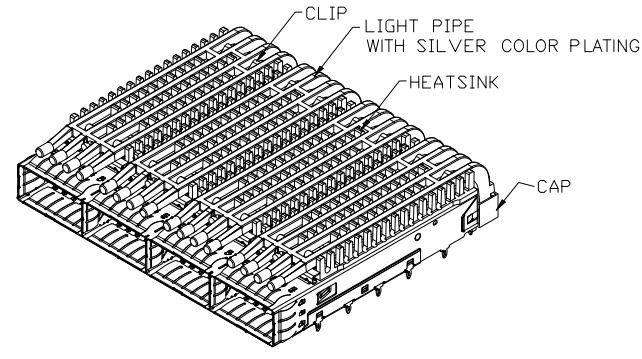
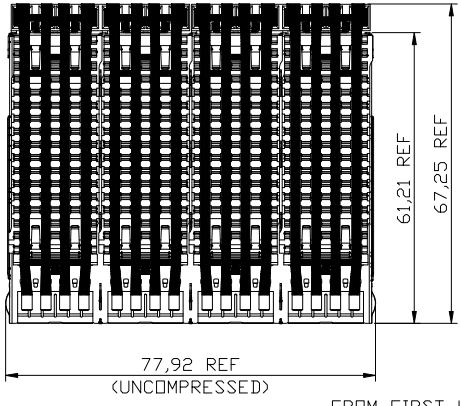

PART NUMBER SELECTION

| | | | |
|-------|-------------|---------------------|---------------|
| 10.7 | NET(13.5mm) | 1 | W/ CAP |
| 9.7 | NET(13.5mm) | 1 | W/ CAP |
| 10.7 | SAN(6.5mm) | 1 | W/ CAP |
| 9.7 | SAN(6.5mm) | 1 | W/ CAP |
| 10.7 | PCI(4.2mm) | 1 | W/ CAP |
| 9.7 | PCI(4.2mm) | 1 | W/ CAP |
| 10.7 | NET(13.5mm) | 0 | W/ CAP |
| 9.7 | NET(13.5mm) | 0 | W/ CAP |
| 10.7 | SAN(6.5mm) | 0 | W/ CAP |
| 9.7 | SAN(6.5mm) | 0 | W/ CAP |
| 10.7 | PCI(4.2mm) | 0 | W/ CAP |
| 9.7 | PCI(4.2mm) | 0 | W/ CAP |
| DIM A | HEAT SINK | REAR LEGS OPTIONALS | CAP OPTIONALS |

CAP OPTIONALS

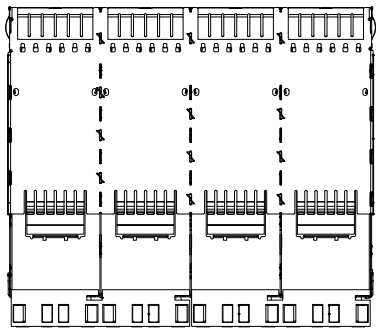
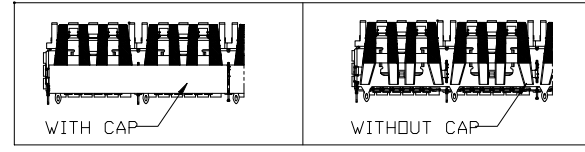

RoHS Compliant

| | | | | | |
|-----------------------|---------|-------------------------------|--------|------------------------------|----------------|
| TOLERANCE UNSPECIFIED | | a vital connector company | | FOR YOUR VITAL CONNECTION | |
| .0 | ± 0.38 | | | TITLE: QSFP+28G 1X4 CAGE | |
| .00 | ± 0.25 | DRAWN BY: | BECKER | PART NO: | S148 X X X 1 X |
| .000 | ± 0.10 | CHECKED BY: | VTA | SIZE: A4 | UNIT:mm |
| ANGLE | ± 3.00° | APPROVED BY: | QPF | PROJECTION | SHEET:30F7 |
| MANUFACTURING COPY | | | | REV: A | FCN: A4 |
| | | | | http://www.vitalconn.com | |

| REV. | ECN. NO. | NAME | DATE |
|------|----------|------|------|
| | | | |

BEZEL AND BOARD POSITION DIMENSION
FOR SINGLE SIDE MOUNTING (SPRING FINGER)

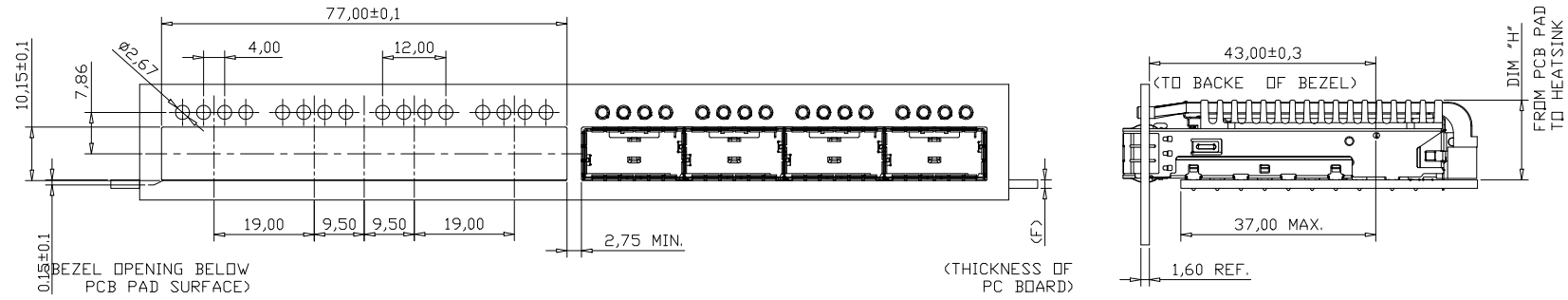

BEZEL AND BOARD POSITION DIMENSION
FOR BELLY TO BELLY MOUNTING (SPRING FINGER)

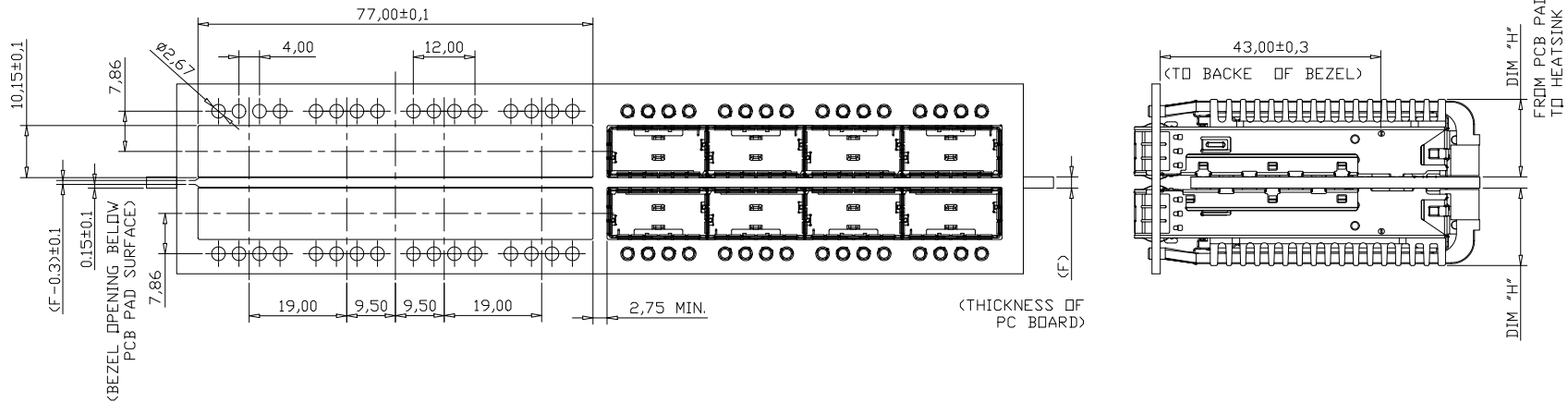

NOTES:

1. THE NORMAL THICKNESS OF CUSTOMER SUPPLIED PC BOARD.(DIM. "F")
SINGLE SIDED PC BOARD THICKNESS: 1.60mm MIN.
BELLY TO BELLY PC BOARD MIN. THICKNESS: 3.0mm MIN.
2. GENERAL TOLERANCE: ±0.05.

RoHS Compliant

| | | | | | |
|-----------------------|---------|--|----------------|------------------------------|---|
| TOLERANCE UNSPECIFIED | | VITALCON a vital connector company | | FOR YOUR VITAL CONNECTION | |
| .0 | ± 0.38 | | | | |
| .00 | ± 0.25 | TITLE: QSFP+28G 1X4 CAGE | | | |
| .000 | ± 0.10 | PART NO: | S148 X X X 1 X | REV: A | |
| ANGLE | ± 3.00° | CHECKED BY: | VTA | SIZE: A4 | UNIT:mm |
| MANUFACTURING COPY | | APPROVED BY: | QPF | PROJECTION | http://www.vitalconn.com |
| | | SHEET:40F7 | | FCN: A4 | |

| REV. | ECN. NO. | NAME | DATE |
|------|----------|------|------|
| | | | |
| | | | |

| | | THE DIMENSION FOR MATING BEZEL (UNIT: mm) | | | | | | |
|------|----------------|---|-------------------|-----------------------|------------|-----------------|------------|---------------------|
| CODE | L/P APPEARANCE | L/P CUT-OUT | L/P PITCH (FRONT) | L/P PITCH (REAR) | L/P HEIGHT | BEZEL THICKNESS | LED HEIGHT | REMARK |
| 0 | NO L/P | | | | | | | WITHOUT LIGHT PIPE |
| A | ROUND | ∅2.67 | 4.00(Equal) | 1,4=15.75 2,3=3.40 | 7.86 | 1.60 | 0.8~1.1 | APPLIES TO QUAD L/P |
| | | ① | ② | ③ | ④ | ⑤ | ⑥ | |

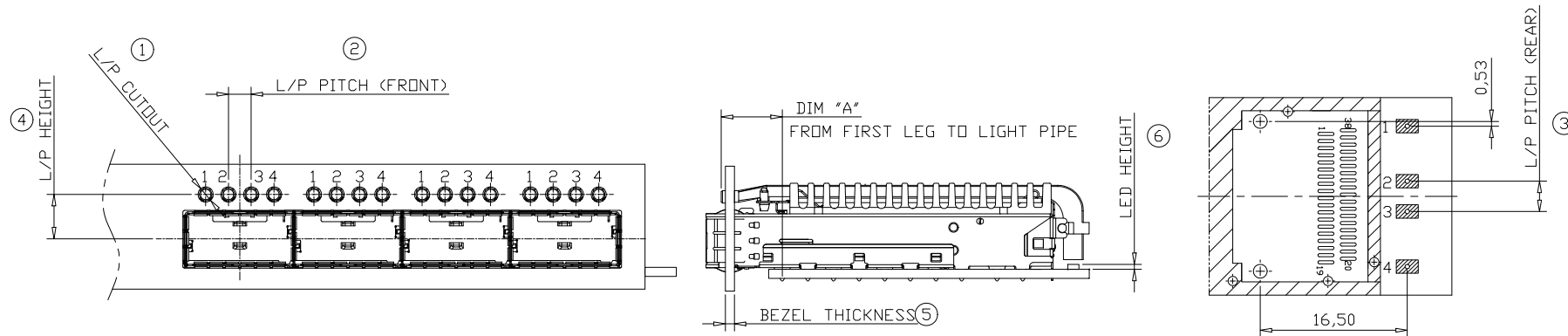

RoHS Compliant

| | | | | | |
|-----------------------|---------|--|--|---------------------------|--|
| TOLERANCE UNSPECIFIED | | VITALCON a vital connector company | | FOR YOUR VITAL CONNECTION | |
| .0 | ± 0.38 | | | TITLE: QSFP+28G 1X4 CAGE | |
| .00 | ± 0.25 | DRAWN BY: BECKER | | PART NO: S148 X X X 1 X | |
| .000 | ± 0.10 | CHECKED BY: VTA | | SIZE: A4 | |
| ANGLE | ± 3.00° | APPROVED BY: QPF | | UNIT:mm | |
| MANUFACTURING COPY | | PROJECTION | | SHEET:50F7 | |
| | | | | REV: A | |
| | | | | FCN: A4 | |
| | | | | http://www.vitalconn.com | |

| REV. | ECN. NO. | NAME | DATE |
|------|----------|------|------|
| | | | |

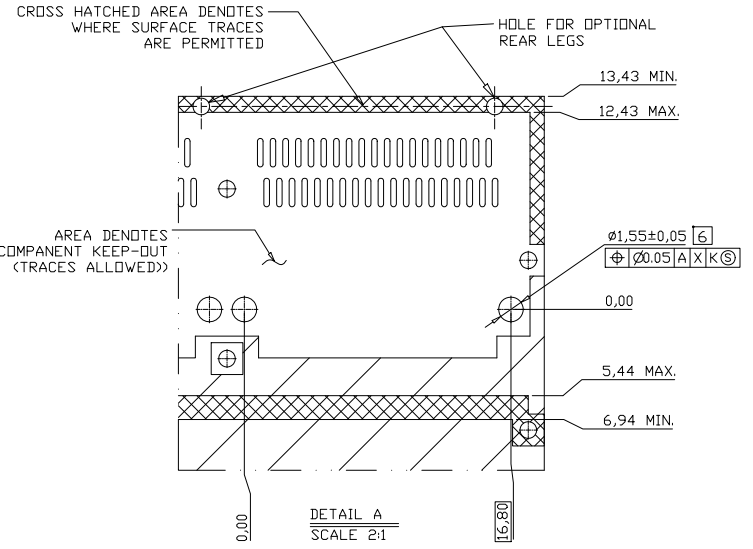
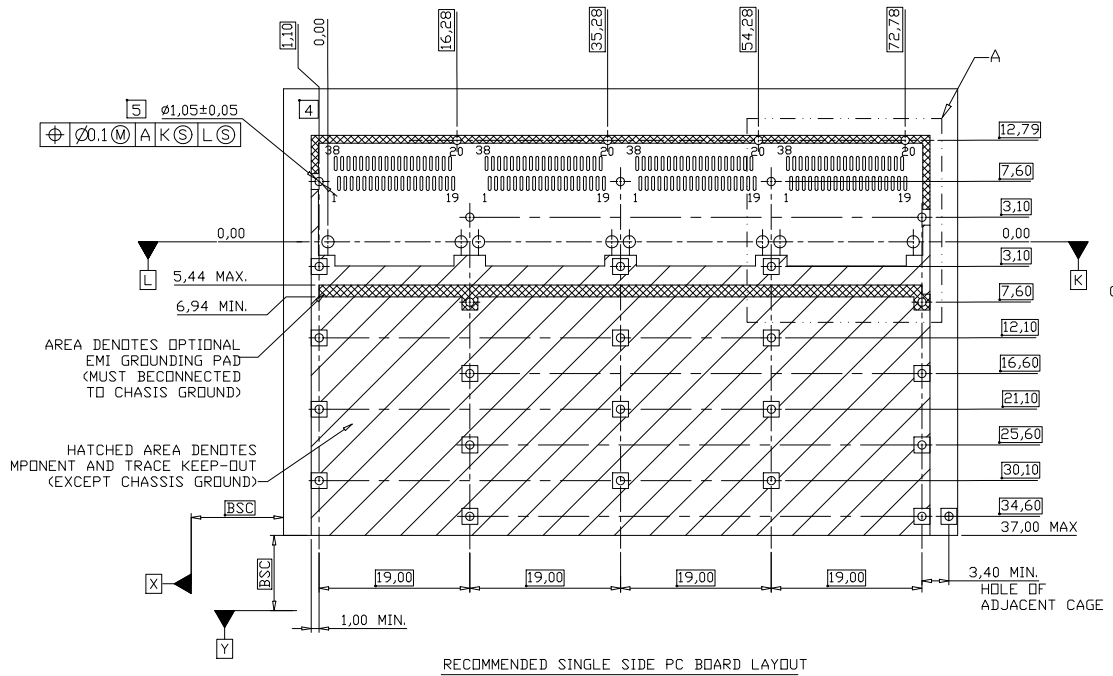

FOR CAGE ASSEMBLIES WITH LIGHT PIPES

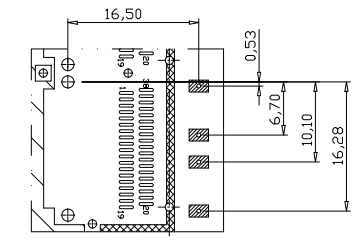

QUAD LIGHT PIPE LED LOCATION

- NOTES:
- DATUM X & Y ARE ESTABLISHED BY THE CUSTOMER'S FIDUCIAL
 - DATUM A IS THE TOP SURFACE OF THE HOST BOARD
 - LOCATION OF THE EDGE OF PCB IS APPLICATION SPECIFIC
 - BASELINE FOR THESE DIMENSIONS IS THE CENTER OF COMPLIANT PIN HOLE.
 - FINISHED HOLE SIZE
 - UNPLATED THRU HOLE.
 - REFER TO SFF8662 FOR CONNECTOR FOOTING DIMENSIONS

RoHS Compliant

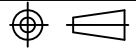
| | | | | | |
|-----------------------|---------|--|--------|------------------------------|---|
| TOLERANCE UNSPECIFIED | | VITALCON a vital connector company | | FOR YOUR VITAL CONNECTION | |
| .0 | ± 0.38 | | | | |
| .00 | ± 0.25 | TITLE: QSFP+28G 1X4 CAGE | | | |
| .000 | ± 0.10 | DRAWN BY: | BECKER | PART NO: | S148 X X X 1 X |
| ANGLE | ± 3.00° | CHECKED BY: | VTA | SIZE: A4 | UNIT:mm |
| MANUFACTURING COPY | | APPROVED BY: | QPF | PROJECTION |  |
| | | | | SHEET:6OF7 | REV: A |
| | | | | FCN: A4 | http://www.vitalconn.com |

| REV. | ECN. NO. | NAME | DATE |
|------|----------|------|------|
| | | | |
| | | | |

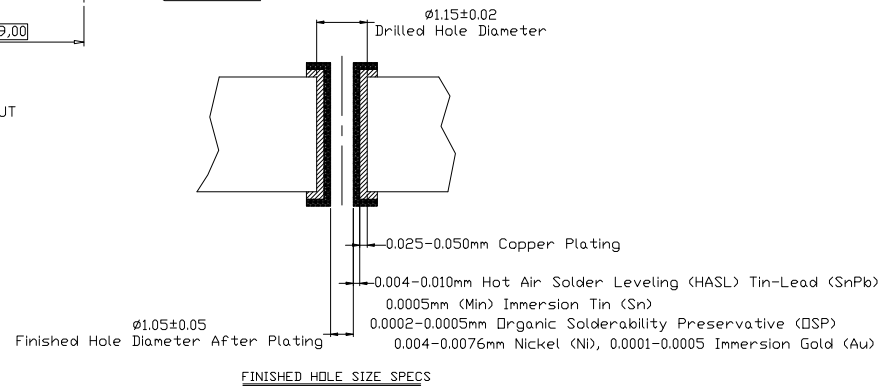
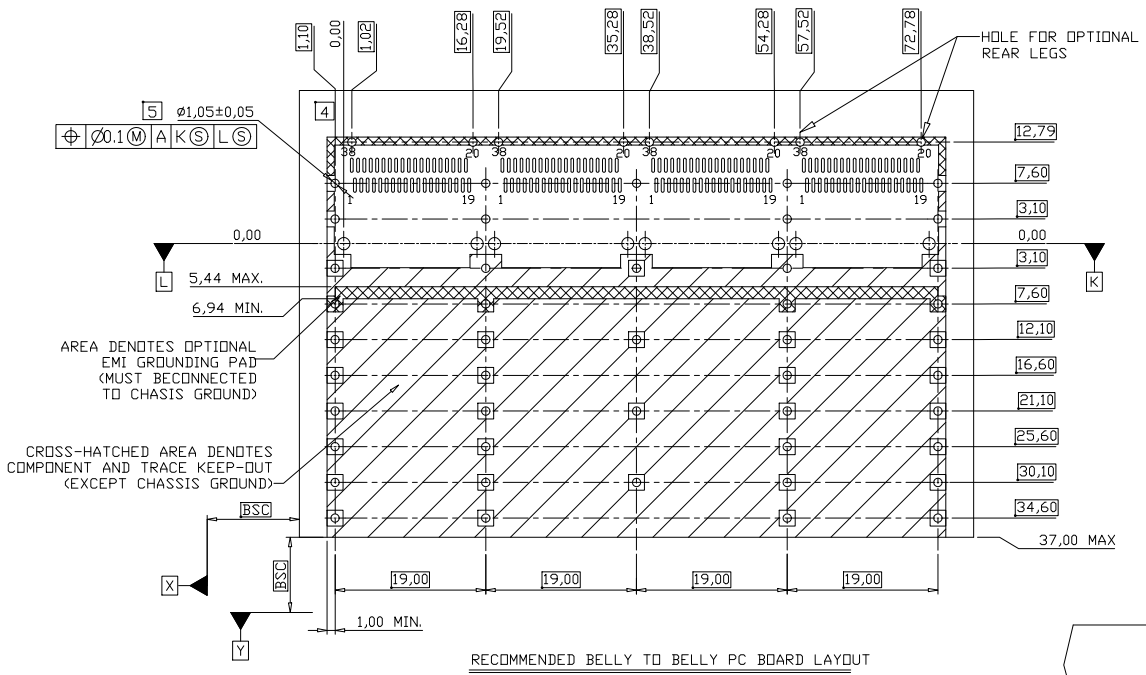

RoHS Compliant

| | | | | | |
|-----------------------|---------|---------------------------|--|---------------------------|--------------------------|
| TOLERANCE UNSPECIFIED | | | | FOR YOUR VITAL CONNECTION | |
| .0 | ± 0.38 | | | | |
| .00 | ± 0.25 | TITLE: QSFPP+28G 1X4 CAGE | | | |
| .000 | ± 0.10 | | | | |
| ANGLE | ± 3.00° | | | | |
| MANUFACTURING COPY | | PART NO: | | S148 X X X 1 X | |
| DRAWN BY: | BECKER | SIZE: A4 | | UNIT:mm | SHEET:70F7 |
| CHECKED BY: | VTA | PROJECTION | | | http://www.vitalconn.com |
| APPROVED BY: | QPF | REV: A | | FCN: A4 | |