

Schottky Barrier Rectifiers

Using the Schottky Barrier principle with a Molybdenum barrier metal. These state-of-the-art geometry features epitaxial construction with oxide passivation and metal overlay contact. Ideally suited for low voltage, high frequency rectification, or as free wheeling and polarity protection diodes.

- * Low Forward Voltage.
- * Low Switching noise.
- * High Current Capacity
- * Guarantee Reverse Avalanche.
- * Guard-Ring for Stress Protection.
- * Low Power Loss & High efficiency.
- * 125 °C Operating Junction Temperature
- * Low Stored Charge Majority Carrier Conduction.
- * Plastic Material used Carries Underwriters Laboratory Flammability Classification 94V-O

SCHOTTKY BARRIER RECTIFIERS

**15 AMPERES
30 -- 60 VOLTS**

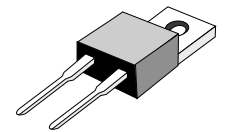

TO-220A

MAXIMUM RATINGS

| Characteristic | Symbol | S15A | | | | | | Unit |
|---|---------------------------------|---------------|----|----|----|----|----|------|
| | | 30 | 35 | 40 | 45 | 50 | 60 | |
| Peak Repetitive Reverse Voltage Working Peak Reverse Voltage DC Blocking Voltage | V_{RRM} V_{RWM} V_R | 70 | 35 | 40 | 45 | 50 | 60 | V |
| RMS Reverse Voltage | $V_{R(RMS)}$ | 21 | 24 | 28 | 31 | 35 | 42 | V |
| Average Rectifier Forward Current | $I_{F(AV)}$ | 15 | | | | | | A |
| Peak Repetitive Forward Current (Rate V_R , Square Wave, 20kHz) | I_{FRM} | 30 | | | | | | A |
| Non-Repetitive Peak Surge Current (Surge applied at rate load conditions halfwave, single phase, 60Hz) | I_{FSM} | 250 | | | | | | A |
| Operating and Storage Junction Temperature Range | T_j, T_{stg} | - 65 to + 125 | | | | | | °C |

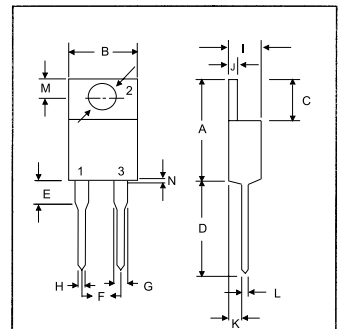

| DIM | MILLMETERS | |
|-----|------------|-------|
| | MIN | MAX |
| A | 14.68 | 15.32 |
| B | 9.78 | 10.42 |
| C | 6.01 | 6.52 |
| D | 13.06 | 14.62 |
| E | 3.57 | 4.07 |
| F | 4.83 | 5.33 |
| G | 1.12 | 1.36 |
| H | 0.72 | 0.96 |
| I | 4.22 | 4.98 |
| J | 1.14 | 1.36 |
| K | 2.20 | 2.97 |
| L | 0.33 | 0.55 |
| M | 2.48 | 2.98 |
| N | -- | 1.00 |
| O | 3.70 | 3.90 |

ELECTRICAL CHARACTERISTICS

| Characteristic | Symbol | S15A | | | | | | Unit |
|--|--------|------|----|------|----|------|----|------|
| | | 30 | 35 | 40 | 45 | 50 | 60 | |
| Maximum Instantaneous Forward Voltage ($I_F = 15$ Amp, $T_C = 25$ °C) ($I_F = 15$ Amp, $T_C = 100$ °C) | V_F | 0.55 | | 0.65 | | 0.55 | | V |
| Maximum Instantaneous Reverse Current (Rated DC Voltage, $T_C = 25$ °C) (Rated DC Voltage, $T_C = 100$ °C) | I_R | 5.0 | | 50 | | | | mA |

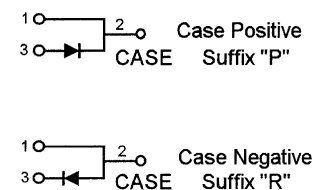

S15A30 thru S15A45

FIG-1 FORWARD CURRENT DERATING CURVE

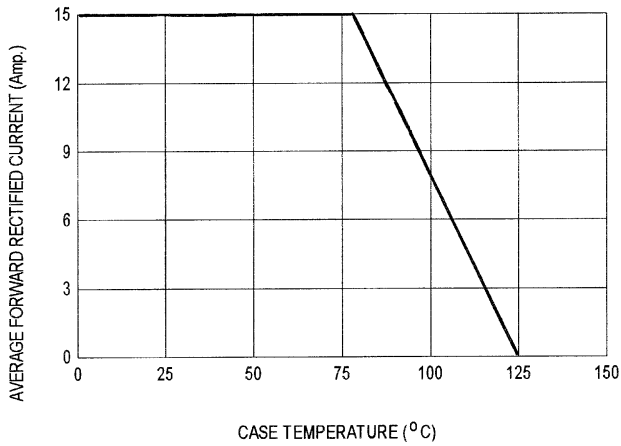

FIG-2 TYPICAL FORWARD CHARACTERISTICS

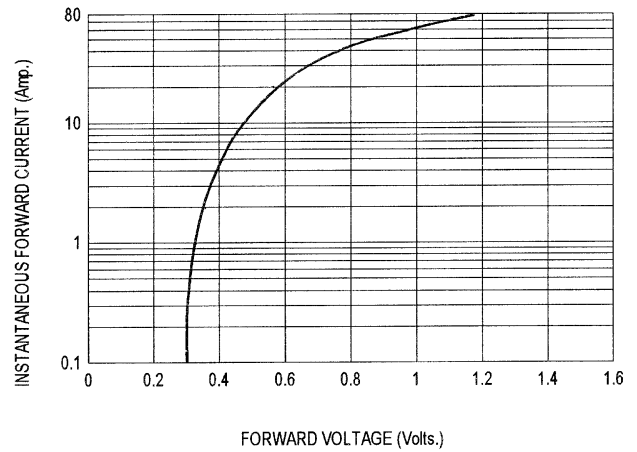

FIG-3 TYPICAL REVERSE CHARACTERISTICS

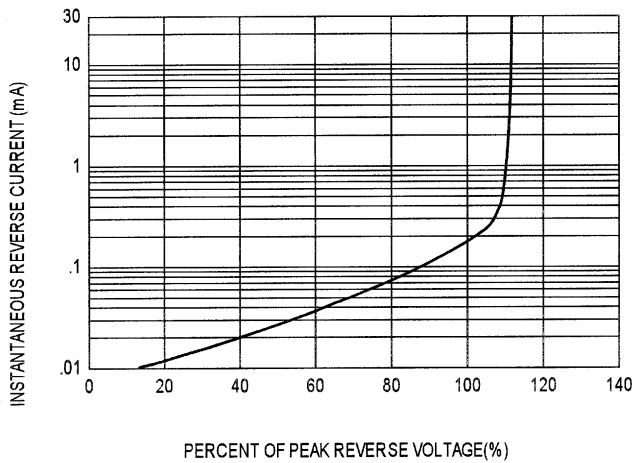

FIG-4 TYPICAL JUNCTION CAPACITANCE

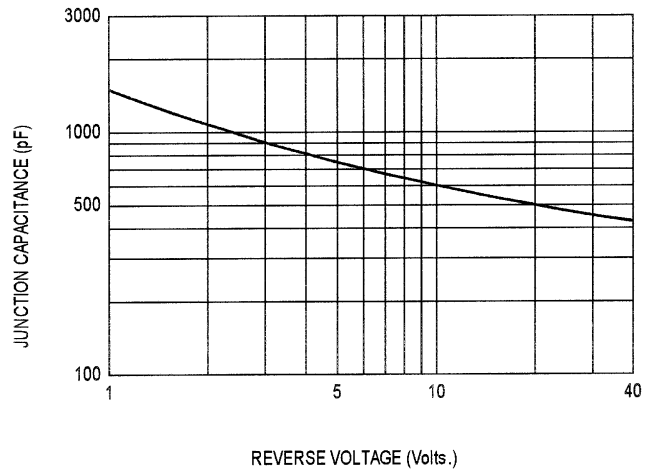
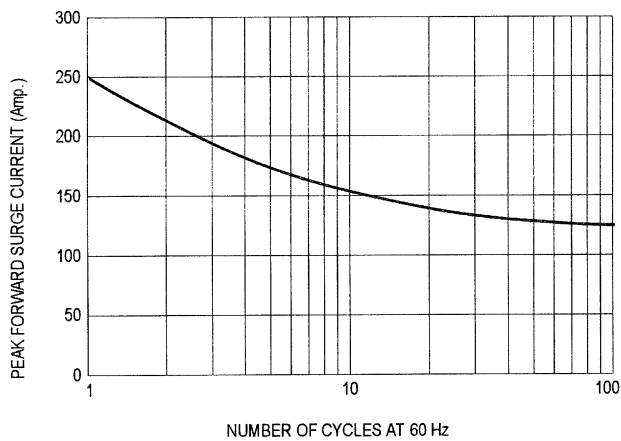

FIG-5 PEAK FORWARD SURGE CURRENT



S15A50 , S15A60

FIG-1 FORWARD CURRENT DERATING CURVE

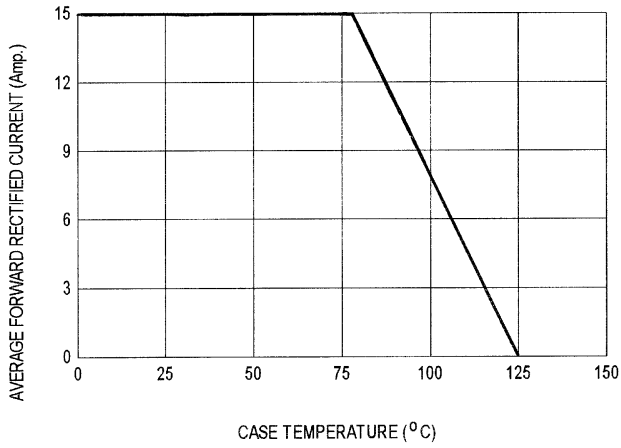

FIG-2 TYPICAL FORWARD CHARACTERISTICS

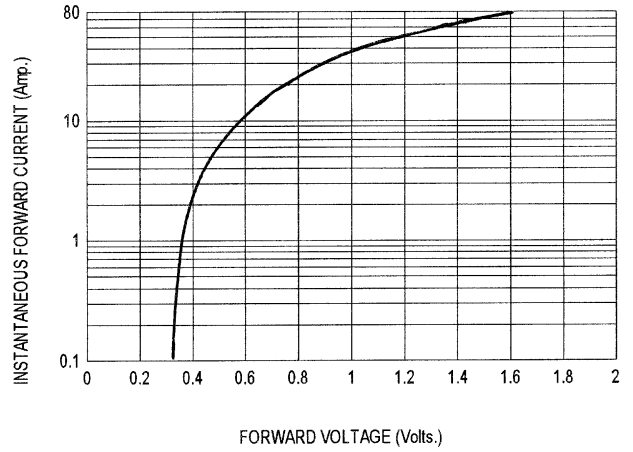

FIG-3 TYPICAL REVERSE CHARACTERISTICS

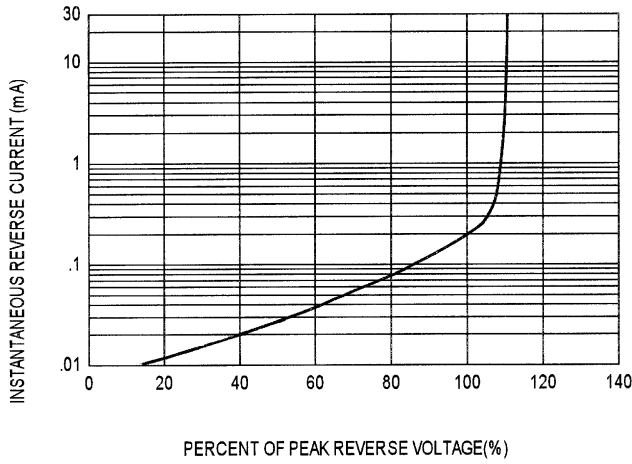

FIG-4 TYPICAL JUNCTION CAPACITANCE

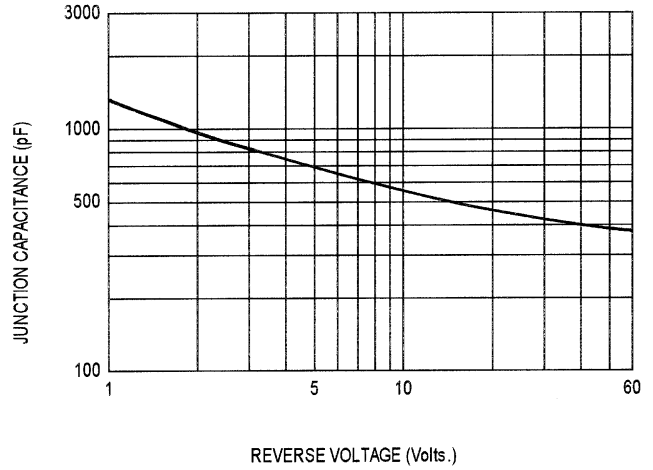

FIG-5 PEAK FORWARD SURGE CURRENT

