

Two-dimensional PSD

S1880, S2044

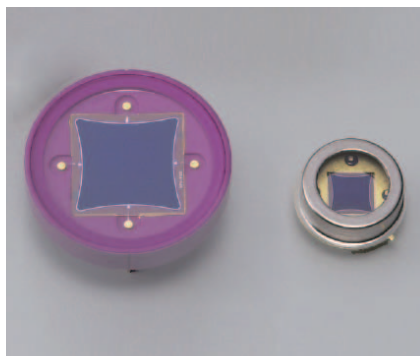

Non-discrete position sensors utilizing photodiode surface resistance

PSD (position sensitive detector) is an optoelectronic position sensor utilizing photodiode surface resistance. Unlike discrete element detectors such as CCD, PSD provides continuous position data and features high position resolution and high-speed response.

Features

- High position resolution
- Wide spectral response range
- High-speed response
- Simultaneous measurements of position and intensity
- Position is measured independent of light spot size.
- High reliability

Applications

- Optical position and angle sensing
- Remote optical control systems
- Automatic range finder systems
- Displacement and vibration monitors
- Laser beam alignment
- Medical equipment

Structure / Absolute maximum ratings

Parameter	Symbol	S1880	S2044	Unit
Package	-	Ceramic	Metal	-
Photosensitive area size	-	12 × 12	4.7 × 4.7	mm
Reverse voltage	V _{R max}	20		V
Operating temperature	T _{opr}	-10 to +60		°C
Storage temperature	T _{stg}	-20 to +80		°C

Note: Exceeding the absolute maximum ratings even momentarily may cause a drop in product quality. Always be sure to use the product within the absolute maximum ratings.

Electrical and optical characteristics (Ta=25 °C unless otherwise noted)

Parameter	Symbol	Condition	S1880			S2044			Unit
			Min.	Typ.	Max.	Min.	Typ.	Max.	
Spectral response range	λ		-	320 to 1060	-	-	320 to 1060	-	nm
Peak sensitivity wavelength	λ_p		-	920	-	-	920	-	nm
Photosensitivity	S	$\lambda = \lambda_p$	-	0.6	-	-	0.6	-	A/W
Interelectrode resistance*1	Rie	Vb=0.1 V	5	10	15	5	10	15	k Ω
Position detection error*2	Zone A	E	-	± 80	± 150	-	± 40	± 100	μm
	Zone B		-	± 150	± 250	-	± 70	± 150	
Saturation current	Ist	VR=5 V RL=1 k Ω	-	0.5	-	-	0.5	-	mA
Dark current	ID	VR=5 V	-	1.0	500	-	0.5	5	nA
Temperature coefficient of ID	TCID		-	1.15	-	-	1.15	-	times/ $^{\circ}\text{C}$
Rise time	tr	VR=5 V RL=1 k Ω	-	1.5	-	-	0.3	-	μs
Terminal capacitance	Ct	VR=5 V f=10 kHz	-	300	-	-	45	-	pF
Position resolution*3	-		-	1.5	-	-	0.6	-	μm

*1: Measured between two output terminals opposite to each other, and the other terminals are open-circuited on measurement.

*2: The radius of Zones A and B depend on the product type. They are determined as follows:

Type no.	Zone A (mm)	Zone B (mm)
S1880	2.5	5
S2044	0.9	4 × 4 (quadrate)

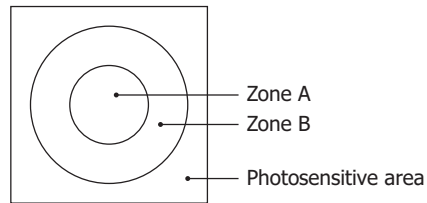

KPSDC0063EA

*3: Position resolution

This is the minimum detectable light spot displacement. The detection limit is indicated by distance on the photosensitive surface. The numerical value of the resolution of a position sensor using a PSD is proportional to both the length of the PSD and the noise of the measuring system (resolution deteriorates) and inversely proportional to the photocurrent (incident energy) of the PSD (resolution improves).

- Light source: LED (900 nm)
- Light spot size: $\phi 200 \mu\text{m}$
- Frequency range: 1 kHz
- Photocurrent: 1 μA
- Circuit system input noise: 1 μV (1 kHz)
- Interelectrode resistance: Typical value (Refer to specification table.)

Spectral response

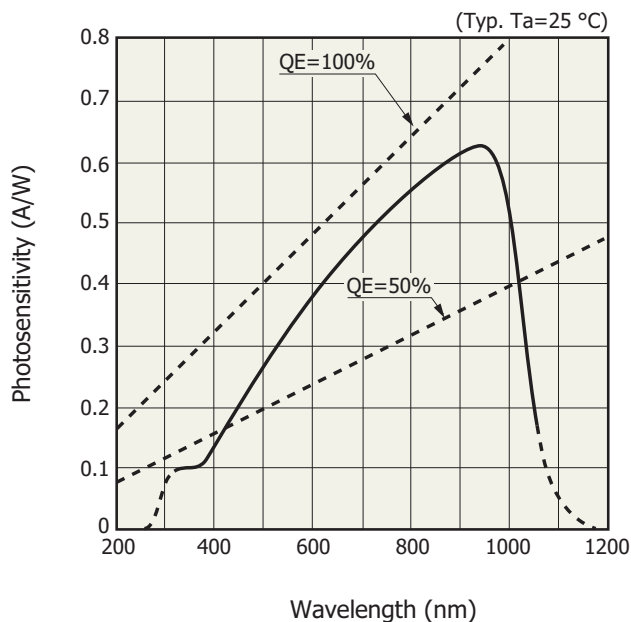

KPSDB0013EB

Photosensitivity temperature characteristics

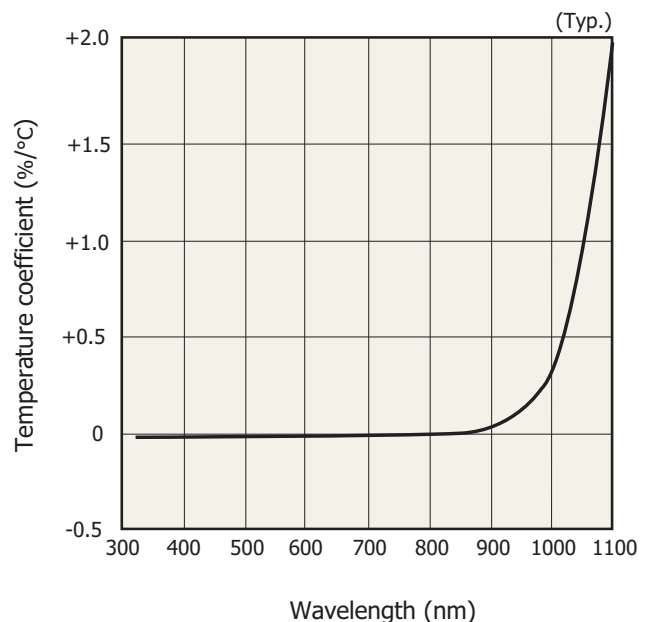

KPSDB0015EB

Terminal capacitance vs. reverse voltage

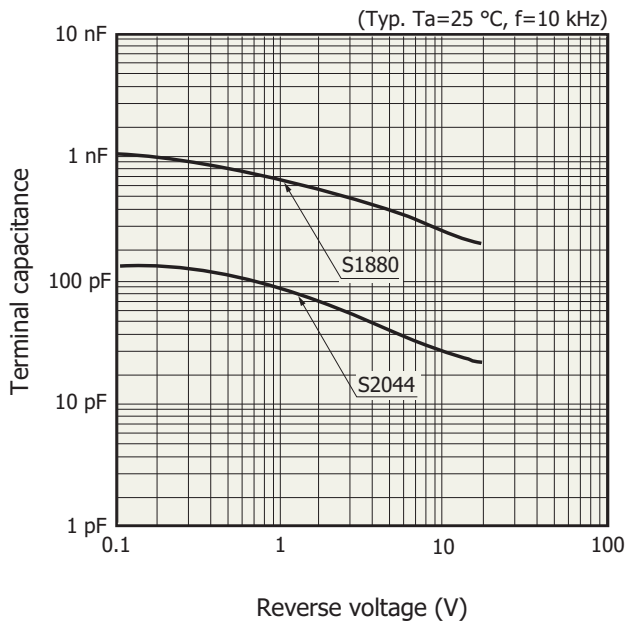

KPSDB0074EB

Examples of position detectability ($T_a=25\text{ }^\circ\text{C}$, $\lambda=900\text{ nm}$, light spot size: $\phi 200\text{ }\mu\text{m}$)

S1880

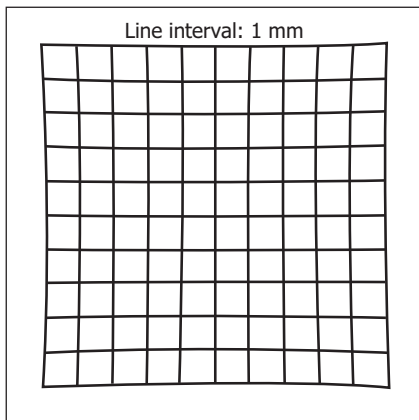

KPSDC0020EA

S2044

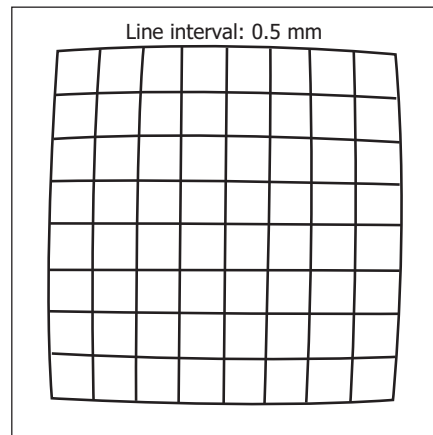

KPSDC0019EA

Example of DC-operating circuit

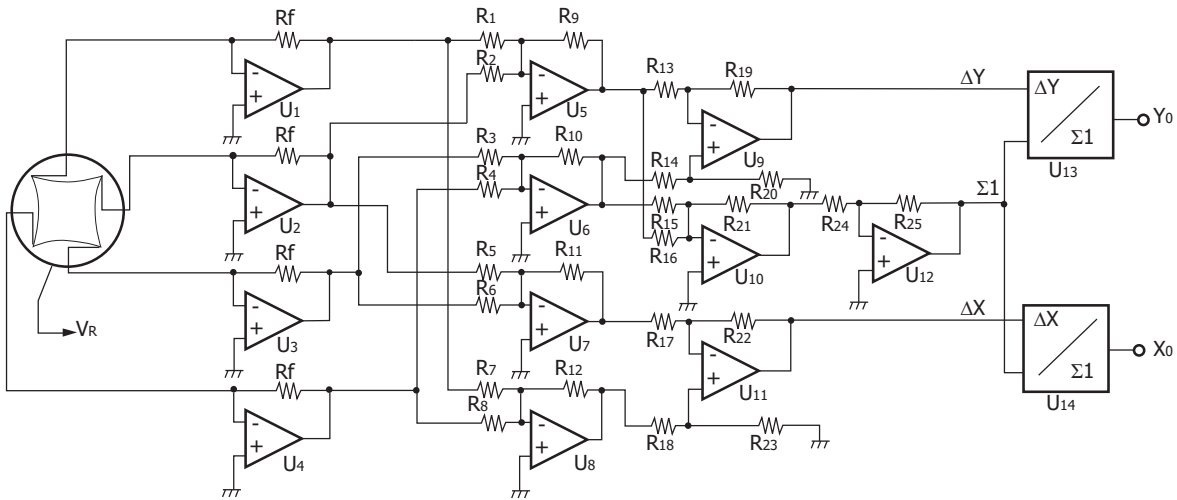

R₁ - R₂₅: same value
 R_f: depends on input level
 U₁ - U₄: low drift head amplifier, TL071, etc.
 U₁₃, U₁₄: analog divider, AD538 (Analog Devices), etc.

KP5DC0026EB

Example of AC-operating circuit

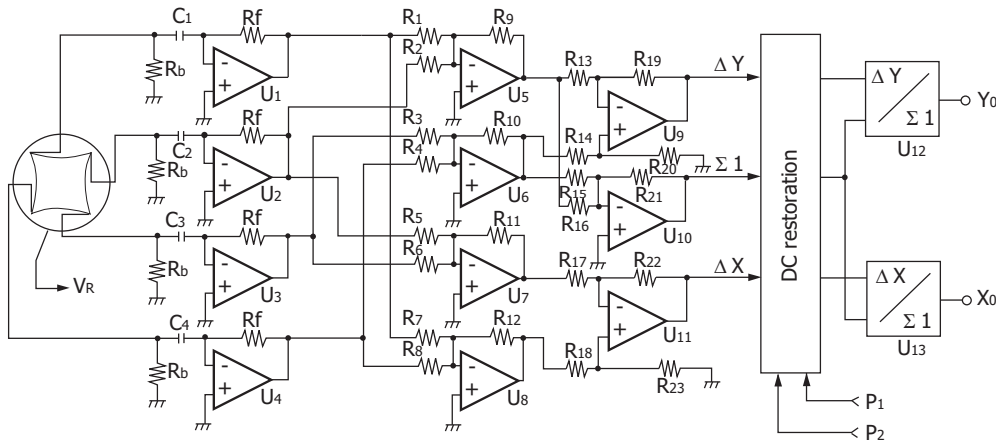

R₁ - R₂₄: same value
 R_f: depends on input level
 U₁ - U₄: low drift head amplifier, TL071, etc.
 U₁₂, U₁₃: analog divider, AD538 (Analog Devices), etc.

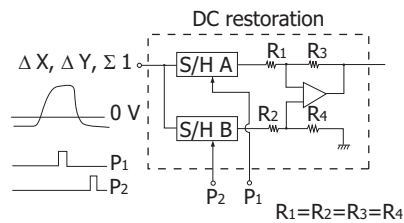

KP5DC0029EB

Dimensional outlines (unit: mm)

S1880

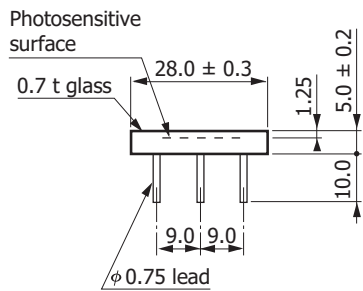
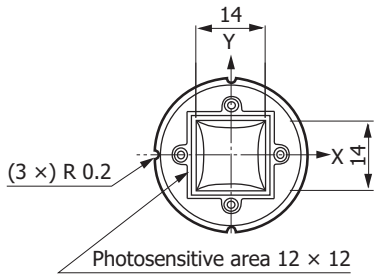

- ① Anode (Y1)
- ② Anode (X1)
- ③ Anode (Y2)
- ④ Anode (X2)
- ⑤ Cathode (common)

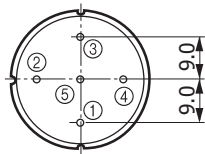

KPSDA0013EC

S2044

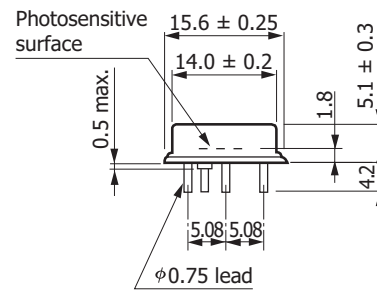
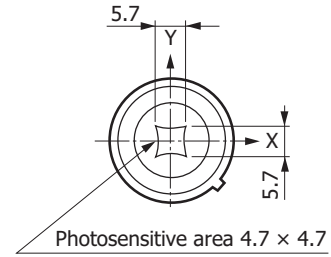

- ① Anode (X2)
- ② Anode (Y2)
- ③ Cathode (case)
- ④ Anode (X1)
- ⑤ Anode (Y1)

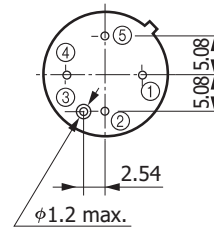

KPSDA0012EC

Photosensitive area chart

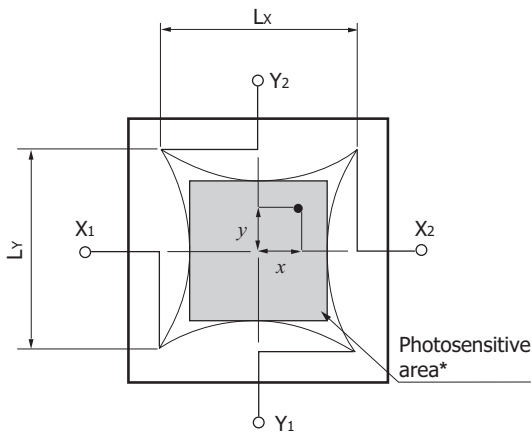

* Photosensitive area is specified at the inscribed square.

KPSDC0012EA

Position conversion formula

$$\frac{(IX_2 + IY_1) - (IX_1 + IY_2)}{IX_1 + IX_2 + IY_1 + IY_2} = \frac{2x}{LX}$$

$$\frac{(IX_2 + IY_2) - (IX_1 + IY_1)}{IX_1 + IX_2 + IY_1 + IY_2} = \frac{2y}{LY}$$

S1880: Lx=14 mm

Ly=14 mm

S2044: Lx=5.7 mm

Ly=5.7 mm

Related information

www.hamamatsu.com/sp/ssd/doc_en.html

■ Precautions

- Disclaimer
- Metal, ceramic, plastic package products
- Surface mount type products

■ Technical note

- PSD

Information described in this material is current as of February 2017.

Product specifications are subject to change without prior notice due to improvements or other reasons. This document has been carefully prepared and the information contained is believed to be accurate. In rare cases, however, there may be inaccuracies such as text errors. Before using these products, always contact us for the delivery specification sheet to check the latest specifications.

The product warranty is valid for one year after delivery and is limited to product repair or replacement for defects discovered and reported to us within that one year period. However, even if within the warranty period we accept absolutely no liability for any loss caused by natural disasters or improper product use. Copying or reprinting the contents described in this material in whole or in part is prohibited without our prior permission.

HAMAMATSU

www.hamamatsu.com

HAMAMATSU PHOTONICS K.K., Solid State Division

1126-1 Ichino-cho, Higashi-ku, Hamamatsu City, 435-8558 Japan, Telephone: (81) 53-434-3311, Fax: (81) 53-434-5184

U.S.A.: Hamamatsu Corporation: 360 Foothill Road, Bridgewater, N.J. 08807, U.S.A., Telephone: (1) 908-231-0960, Fax: (1) 908-231-1218

Germany: Hamamatsu Photonics Deutschland GmbH: Arzbergerstr. 10, D-82211 Herrsching am Ammersee, Germany, Telephone: (49) 8152-375-0, Fax: (49) 8152-265-8

France: Hamamatsu Photonics France S.A.R.L.: 19, Rue du Saule Trapu, Parc du Moulin de Massy, 91882 Massy Cedex, France, Telephone: 33-(1) 69 53 71 00, Fax: 33-(1) 69 53 71 10

United Kingdom: Hamamatsu Photonics UK Limited: 2 Howard Court, 10 Tewin Road, Welwyn Garden City, Hertfordshire AL7 1BW, United Kingdom, Telephone: (44) 1707-294888, Fax: (44) 1707-325777

North Europe: Hamamatsu Photonics Norden AB: Torshamnsgatan 35 16440 Kista, Sweden, Telephone: (46) 8-509-031-00, Fax: (46) 8-509-031-01

Italy: Hamamatsu Photonics Italia S.r.l.: Strada della Moia, 1 int. 6, 20020 Arese (Milano), Italy, Telephone: (39) 02-93581733, Fax: (39) 02-93581741

China: Hamamatsu Photonics (China) Co., Ltd.: B1201, Jiaming Center, No.27 Dongsanhuan Beilu, Chaoyang District, Beijing 100020, China, Telephone: (86) 10-6586-6006, Fax: (86) 10-6586-2866