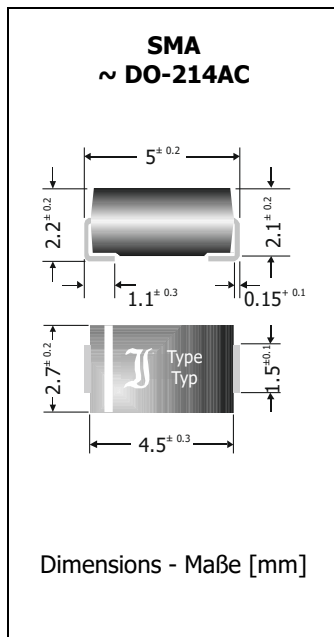

S1A ... S1Y
Standard Recovery SMD Rectifier Diodes
SMD-Gleichrichterdioden mit Standard-Sperrverzug
 $I_{FAV} = 1 \text{ A}$
 $V_F < 1.1 \text{ V}$
 $T_{jmax} = 150^\circ\text{C}$
 $V_{RRM} = 50...2000 \text{ V}$
 $I_{FSM} = 30/32 \text{ A}$
 $t_{rr} \sim 1500 \text{ ns}$

Version 2019-01-29

**Typical Applications**
50/60 Hz Mains Rectification,
Power Supplies, Polarity Protection
Commercial grade
Suffix -Q: AEC-Q101 compliant ¹⁾
Suffix -AQ: in AEC-Q101 qualification ¹⁾
Features
 V_{RRM} up to 2000 V
For 1.5A and Avalanche version:
Refer to BYG10 series
Compliant to RoHS, REACH,
Conflict Minerals ¹⁾
Mechanical Data ¹⁾
Taped and reeled 7500 / 13"
Weight approx. 0.07 g
Case material UL 94V-0
Solder & assembly conditions 260°C/10s
MSL = 1
**Typische Anwendungen**
50/60 Hz Netzgleichrichtung,
Stromversorgungen, Verpolschutz
Standardausführung
Suffix -Q: AEC-Q101 konform ¹⁾
Suffix -AQ: in AEC-Q101 Qualifikation ¹⁾
Besonderheiten
 V_{RRM} bis zu 2000 V
Für 1.5A und Avalanche-Ausführung:
siehe BYG10-Reihe
Konform zu RoHS, REACH,
Konfliktmineralien ¹⁾
Mechanische Daten ¹⁾
Gegurtet auf Rolle
Gewicht ca.
Gehäusematerial
Löt- und Einbaubedingungen
Maximum ratings ²⁾**Grenzwerte ²⁾**

Type Typ	DC blocking voltage Sperrgleichspannung V_{DC} [V] ³⁾	Repetitive peak reverse voltage Periodische Spitzensperrspannung V_{RRM} [V]	Surge peak reverse voltage Stoßspitzensperrspannung V_{RSM} [V]
S1A		50	50
S1B		100	100
S1D		200	200
S1G/-Q/-AQ	320	400	400
S1J/-Q/-AQ	480	600	600
S1K		800	800
S1M/-Q/-AQ	800	1000	1000
S1T		1300	1300
S1W/-Q		1600	1600
S1X		1800	1800
S1Y/-Q		2000	2000

Max. average forward rectified current – Dauergrenzstrom in Einwegschaltung	$T_T = 100^\circ\text{C}$	I_{FAV}	1 A
Repetitive peak forward current – Periodischer Spitzenstrom	$f > 15 \text{ Hz}$	$T_T = 100^\circ\text{C}$	I_{FRM} 6 A
Peak forward surge current Stoßstrom in Fluss-Richtung	Half sine-wave Sinus-Halbwellen	50 Hz (10 ms) 60 Hz (8.3 ms)	I_{FSM} 30 A 32 A
Rating for fusing – Grenzlasterintegral	$t < 10 \text{ ms}$	i^2t	4.5 A ² s
Reverse avalanche energy – Avalanche-Energie in Sperr-Richtung		E_{RSM}	N/A
Junction / Storage temperature – Sperrschicht-/Lagerungstemperatur		$T_{j/s}$	-50...+150°C

- Please note the [detailed information on our website](#) or at the beginning of the data book
Bitte beachten Sie die [detaillierten Hinweise auf unserer Internetseite](#) bzw. am Anfang des Datenbuches
- $T_A = 25^\circ\text{C}$ unless otherwise specified – $T_A = 25^\circ\text{C}$ wenn nicht anders angegeben
- Defined for -AQ parts only – Nur definiert für -AQ Bauteile

Characteristics

Kennwerte

Forward voltage – Durchlass-Spannung	$T_j = 25^\circ\text{C}$	$I_F = 1\text{ A}$	V_F	< 1.1
Leakage current Sperrstrom	$T_j = 25^\circ\text{C}$ $T_j = 100^\circ\text{C}$	$V_R = V_{RRM}$	I_R	< 5 μA < 50 μA
Typical junction capacitance – Typische Sperrschichtkapazität		$V_R = 4\text{ V}$	C_j	6 pF
Reverse recovery time – Sperrverzug	$I_F = 0.5\text{ A}$ through/über $I_R = 1\text{ A}$ to $I_R = 0.25\text{ A}$		t_{rr}	typ. 1500 ns
Typ. thermal resistance junction-ambient – Typ. Wärmewiderstand Sperrschicht-Umgebung			R_{thA}	75 K/W
Typ. thermal resistance junction-terminal – Typ. Wärmewiderstand Sperrschicht-Anschluss			R_{thT}	30 K/W

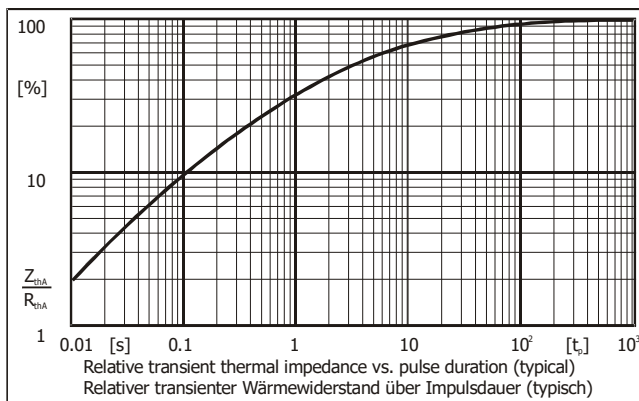
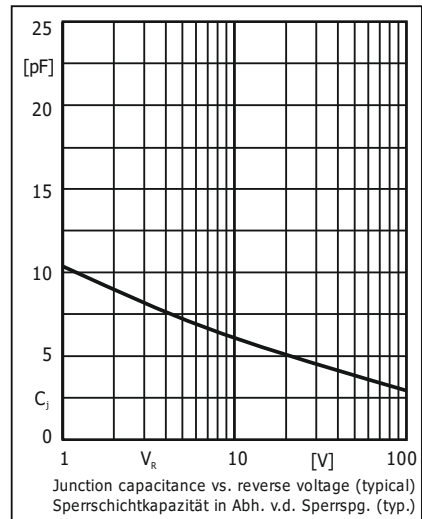
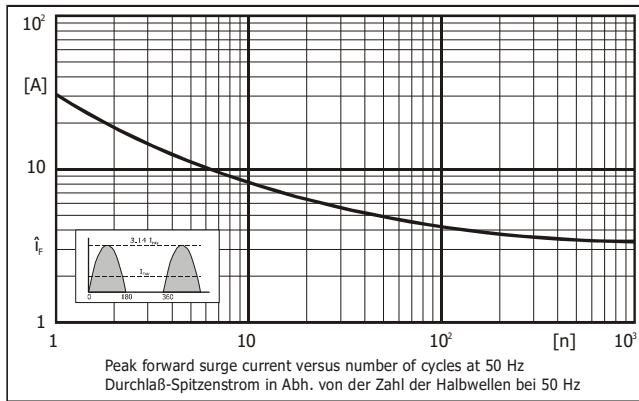
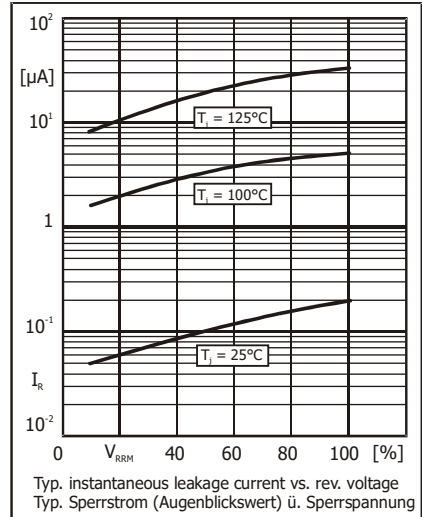
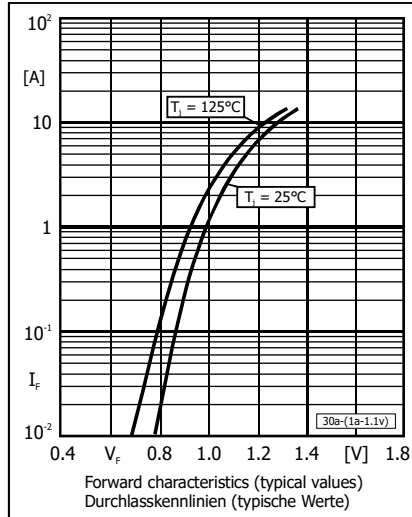
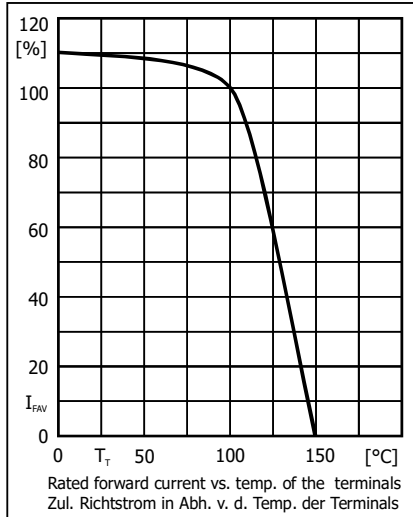

Disclaimer: See data book page 2 or [website](#)
Haftungssausschluss: Siehe Datenbuch Seite 2
oder [Internet](#)

1 Mounted on P.C. board with 25 mm² copper pads at each terminal
Montage auf Leiterplatte mit 25 mm² Kupferpad je Anschluss