

**S1A ... S1Y**

**Standard Recovery SMD Rectifier Diodes**  
**SMD-Gleichrichterdioden mit Standard-Sperrverzug**

$I_{FAV} = 1 \text{ A}$   
 $V_F < 1.1 \text{ V}$   
 $T_{jmax} = 150^\circ\text{C}$

$V_{RRM} = 50...2000 \text{ V}$   
 $I_{FSM} = 30/32 \text{ A}$   
 $t_{rr} \sim 1500 \text{ ns}$

Version 2019-01-29

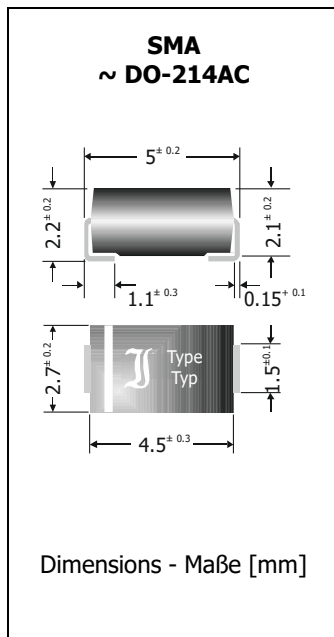
**Typical Applications**

50/60 Hz Mains Rectification,  
 Power Supplies, Polarity Protection  
 Commercial grade  
 Suffix -Q: AEC-Q101 compliant <sup>1)</sup>  
 Suffix -AQ: in AEC-Q101 qualification <sup>1)</sup>

**Features**

$V_{RRM}$  up to 2000 V  
 For 1.5A and Avalanche version:  
 Refer to BYG10 series  
 Compliant to RoHS, REACH,  
 Conflict Minerals <sup>1)</sup>

**Mechanical Data <sup>1)</sup>**

Taped and reeled 7500 / 13"  
 Weight approx. 0.07 g  
 Case material UL 94V-0  
 Solder & assembly conditions 260°C/10s  
 MSL = 1

**Typische Anwendungen**

50/60 Hz Netzgleichrichtung,  
 Stromversorgungen, Verpolschutz  
 Standardausführung  
 Suffix -Q: AEC-Q101 konform <sup>1)</sup>  
 Suffix -AQ: in AEC-Q101 Qualifikation <sup>1)</sup>

**Besonderheiten**

$V_{RRM}$  bis zu 2000 V  
 Für 1.5A und Avalanche-Ausführung:  
 siehe BYG10-Reihe  
 Konform zu RoHS, REACH,  
 Konfliktmineralien <sup>1)</sup>

**Mechanische Daten <sup>1)</sup>**

Gegurtet auf Rolle  
 Gewicht ca.  
 Gehäusematerial  
 Löt- und Einbaubedingungen

**Maximum ratings <sup>2)</sup>****Grenzwerte <sup>2)</sup>**

Type Typ	DC blocking voltage Sperrgleichspannung $V_{DC}$ [V] <sup>3)</sup>	Repetitive peak reverse voltage Periodische Spitzensperrspannung $V_{RRM}$ [V]	Surge peak reverse voltage Stoßspitzensperrspannung $V_{RSM}$ [V]
S1A		50	50
S1B		100	100
S1D		200	200
S1G/-Q/-AQ	320	400	400
S1J/-Q/-AQ	480	600	600
S1K		800	800
S1M/-Q/-AQ	800	1000	1000
S1T		1300	1300
S1W/-Q		1600	1600
S1X		1800	1800
S1Y/-Q		2000	2000

Max. average forward rectified current – Dauergrenzstrom in Einwegschaltung	$T_T = 100^\circ\text{C}$	$I_{FAV}$	1 A
Repetitive peak forward current – Periodischer Spitzenstrom	$f > 15 \text{ Hz}$	$T_T = 100^\circ\text{C}$	$I_{FRM}$ 6 A
Peak forward surge current Stoßstrom in Fluss-Richtung	Half sine-wave 50 Hz (10 ms) Sinus-Halbwellen 60 Hz (8.3 ms)	$I_{FSM}$	30 A 32 A
Rating for fusing – Grenzlasterintegral	$t < 10 \text{ ms}$	$i^2t$	4.5 A <sup>2</sup> s
Reverse avalanche energy – Avalanche-Energie in Sperr-Richtung		$E_{RSM}$	N/A
Junction / Storage temperature – Sperrschicht-/Lagerungstemperatur		$T_{j/s}$	-50...+150°C

- Please note the [detailed information on our website](#) or at the beginning of the data book  
 Bitte beachten Sie die [detaillierten Hinweise auf unserer Internetseite](#) bzw. am Anfang des Datenbuches
- $T_A = 25^\circ\text{C}$  unless otherwise specified –  $T_A = 25^\circ\text{C}$  wenn nicht anders angegeben
- Defined for -AQ parts only – Nur definiert für -AQ Bauteile

**Characteristics**

**Kennwerte**

Forward voltage – Durchlass-Spannung	$T_j = 25^\circ\text{C}$	$I_F = 1\text{ A}$	$V_F$	< 1.1
Leakage current Sperrstrom	$T_j = 25^\circ\text{C}$ $T_j = 100^\circ\text{C}$	$V_R = V_{RRM}$	$I_R$	< 5 $\mu\text{A}$ < 50 $\mu\text{A}$
Typical junction capacitance – Typische Sperrschichtkapazität		$V_R = 4\text{ V}$	$C_j$	6 pF
Reverse recovery time – Sperrverzug	$I_F = 0.5\text{ A}$ through/über $I_R = 1\text{ A}$ to $I_R = 0.25\text{ A}$		$t_{rr}$	typ. 1500 ns
Typ. thermal resistance junction-ambient – Typ. Wärmewiderstand Sperrschicht-Umgebung			$R_{thA}$	75 K/W
Typ. thermal resistance junction-terminal – Typ. Wärmewiderstand Sperrschicht-Anschluss			$R_{thT}$	30 K/W

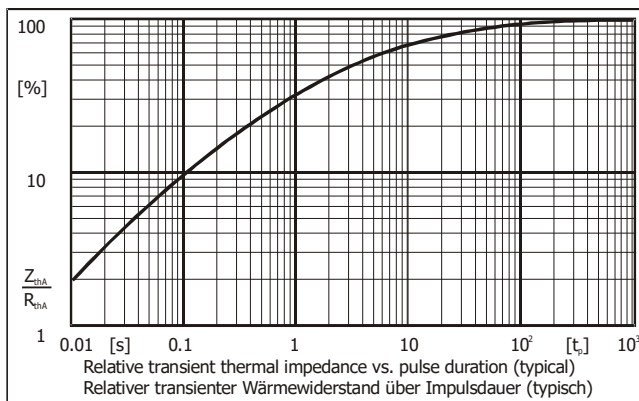
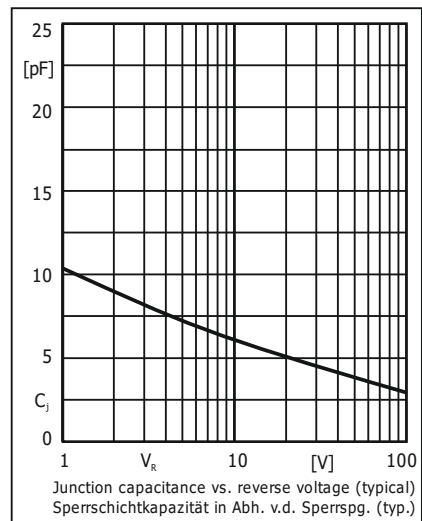
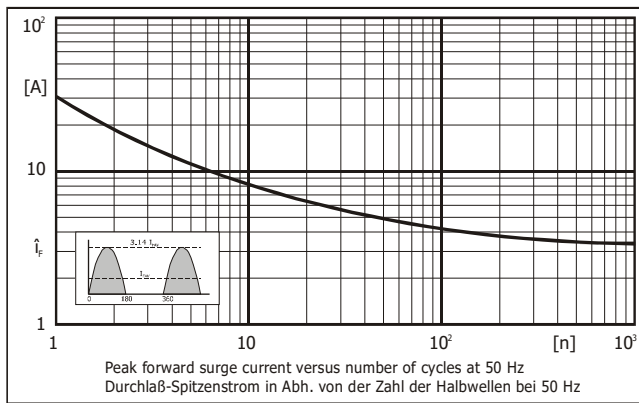
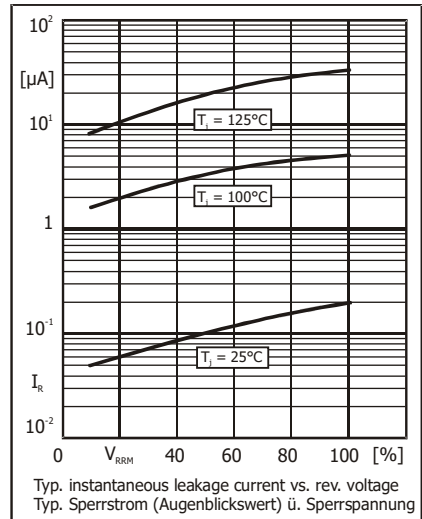
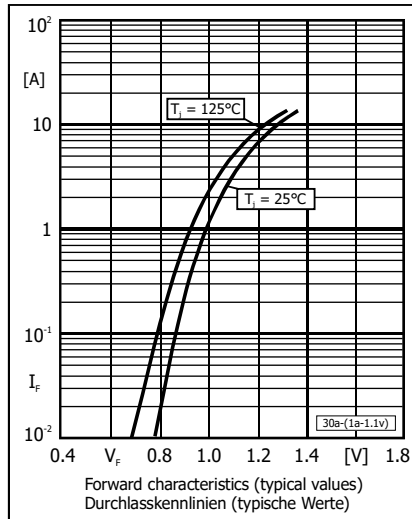
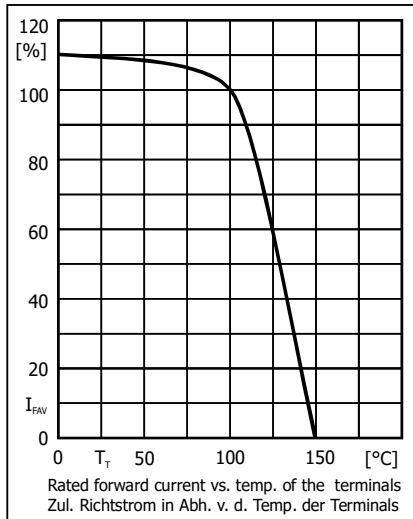

**Disclaimer:** See data book page 2 or [website](#)  
**Haftungssausschluss:** Siehe Datenbuch Seite 2 oder [Internet](#)

1 Mounted on P.C. board with 25 mm<sup>2</sup> copper pads at each terminal  
 Montage auf Leiterplatte mit 25 mm<sup>2</sup> Kupferpad je Anschluss