

**SIOV's Metal Oxide Varistors for Transient Suppression****Features:**

- Nanosec. Switching Response Time, < 15 nsec. with minimal lead length.
- High Transient Current Capability (up to 70,000 Amps).
- No Extinguishing or Follow-on Current Limitations.
- Small Size for Compact Designs
- Wide Operating Temperature Range - 40 to + 85 degrees C.
- Compatible with Automatic Insertion. Tape and reel configuration available on SO5 and SO7 series. Contact marketing for details.
- Excellent Clamping Characteristics.
- Low Standby Power Consumption.

**Benefits:**

- Eliminates Dangerous Voltage Transients.
- Lowers Overall System Costs by Reducing Downtime and Maintenance Costs.
- Improves Component and System Reliability.
- Reduces Lightning Effects.
- Reduces EMP/RFI Interference.
- Promotes Personal Safety.

The SIOV will fit applications requiring protection at operating voltage levels as low as 11 volts and as high as 1100 volts with energies rated up to 10,000 Joules, depending on the device selected.

SIOVs, Siemens Metal Oxide Varistors, are non-linear voltage dependent resistors, having symmetrical voltage/current (V-I) characteristics similar to back-to-back Zener Diodes. This Varistor V-I characteristic is defined by the equation  $I = kV^\alpha$ , where k is a varistor constant dependent on geometry,  $\alpha$  (alpha) is the non-linearity exponent.

Alpha is a figure of merit, which essentially is a measure of the suppression effectiveness. SIOV's have alphas in excess of 30 without sacrificing energy-handling and surge-current capabilities. SIOV's are ideal in protecting equipment and personnel against moderately powerful voltage transients, which may be generated by lightning, internal switching or power faults. RFI associated with communication equipment is also reduced substantially. Protection with Varistors will not only improve system reliability, but will reduce system costs by the relaxation of active/passive component specifications. In addition, maintenance costs and associated down time costs are reduced substantially.

For high-frequency applications requiring protectors with low losses during normal operating conditions (i.e., high insulation resistance and low capacitance), and high current-carrying capability, consider gasfilled Surge Voltage Protectors (SVP's).

**Typical protection applications:**

- Protection of semiconductors (diodes, transistors, thyristors, IC's etc.)
- Appliances connected to 110V or 220V AC.
- Industrial equipment vulnerable to transients on the AC power line (computers, traffic controls, motor controllers, etc.)
- Protection of equipment connected to telephone or signal lines, such as security systems, railroad equipment, fire alarm systems, etc.
- Arc suppression across relay and switch contacts.
- Protection of instrument input terminals from accidentally connected high voltages.
- Power control equipment for power distribution lines.
- GFI (Ground Fault Interrupters).

**Summary of SIOV Characteristics**

SIOV Metal Oxide Varistors are available in 2 basic configurations:

- Disc types (part number prefix "S")—Radial-leaded, for protection in low and medium exposure environments, typically installed in PC boards.
- Block types (part number prefix "B")—High-energy types for protection on severe transient environments, chassis mounted.

	Disc Types	Block Types
Rated Voltage, AC (RMS volts) Rated Voltage, DC (Volts)	11-1000 15-1465	75-1100 100-1465
Rated Peak Single Pulse Transient Current (Amps)	100-6500	25000-70000
Rated Single Pulse Transient Energy (Joules)	0.3-500	350-10300
Storage Temperature Range	- 40° to + 125°C	- 40°C to + 110°C
Operating Temperature Range	- 40°C to + 85°C	
Response Time	< 15 nsec	
Voltage Temperature Coefficient	< - 0.05% / °C	

A-11-09

## SIOV Selection Procedure

**1. Determine required voltage rating**

First, the maximum steady-state operating voltage of the circuit must be determined. Care must be taken to use the upper tolerance limit of the voltage source e.g., for a 220 VAC line, a 10% high line condition should be assumed, resulting in 242V. Once this level is determined, refer to the column in the data headed "Rated voltage" and select a group having the nearest greater value to this level.

**2. Determine energy requirements**

A given group of varistors having the same maximum continuous applied voltage rating will have various energy ratings corresponding to the diameter of the varistor element. These ratings are the maximum allowable energies for a single current impulse while maximum continuous voltage is also applied and the resulting shift of varistor voltage is less than  $\pm 10\%$  of initial value.

Energy content of a transient source may be easily calculated when the source is a known inductance (i.e., solenoid, transformer, or motor). For a simple inductance, the maximum energy is  $E_{max} = \frac{1}{2} L I_p^2$ , where L is the value of the inductance and  $I_p$  is the peak current. In the case of a single phase transformer, energy may be calculated by  $E = \frac{m p}{2 \pi f}$ , where m is the ratio of rms magnetizing current to rms maximum rated load current, p is the VA rating of the transformer, and f is the line frequency. There is a relationship between m and p which depends to some extent on the core material, and may be approximated from the following table:

p (kVA)	0.1	3	10	100	200	500	1000
m	0.1	0.05	0.032	0.027	0.024	0.020	0.015

In a situation where transients are actually occurring, it may be possible to measure, by means of an oscilloscope, the peak voltage waveshape and duration of a transient. Maximum peak current may be calculated by dividing the peak voltage by the source impedance. A trial device may be selected from the group determined in step 1, and the energy that would be absorbed may be calculated by  $E = \int v \cdot i dt$ . If the selected device cannot handle the energy, then a larger device should be selected and the calculation repeated.

**3. Check peak current rating**

When the transient source is an inductance, the peak current in the varistor will be equal to the current stored in the inductance at the time of switching. Then, the duration of the current must be determined by measurement or by calculation. The calculation is performed by means of the equation

$$\tau = \frac{L}{R_L + R_{SIOV}}$$

where  $\tau$  = "pulse width" which is the basis for surge lifetime ratings.

$R_L$  = resistance of the inductor

$R_{SIOV}$  = resistance of the SIOV, determined at the peak current value by referring to the V-I characteristic of the selected SIOV.

L = inductance

Naturally, the varistor resistance does not remain constant as the current decays, but this may be neglected as it is taken into account in the ratings.

Referring to the graphs of Surge Lifetime Ratings, it can be determined

if the peak current and the desired life are within the capabilities of the selected varistor. If not, a larger diameter varistor must be selected.

**4. Calculate power dissipation**

Normally, transients occur infrequently and thus dissipate little power in the varistor. In circuits, where frequent switching occurs, however, it is necessary to make sure the varistor's dissipation rating is not exceeded. This can be calculated by  $P = \frac{E}{T}$ , where E = energy in a single transient, and T = pulse repetition period.

In addition, for operation above 85°C, the listed values must be derated linearly from 100% at 85°C to 0% at 110°C for the block types and 125°C for the disc types.

**Protection from Unknown Transients**

Electronic equipment used in commercial, industrial, and residential locations contain circuitry sensitive to transients. However, the knowledge of protection design is relatively incomplete. Definition of the environment is being undertaken by the Surge Protective Devices Committee of the IEEE and other groups, such as ANSI and the FCC.

Since it may not be known what types of transients to expect, selection of the required energy/transient current ratings should balance the cost of the varistor against such factors as reliability, cost of the equipment, cost of downtime, and equipment duty cycle. For example, for small consumer items a 5mm type may be optimum, whereas industrial equipment, elevator controls, and large computers would benefit from a 20mm or block type.

## Definition of Terms

Parameter	Description	Parameter	Description
Rated voltage:	Highest permissible steady-state operating voltage that the varistor can withstand without excessive power dissipation.	Rated Transient average power dissipation:	Maximum average power which may be dissipated due to a group of pulses occurring within a specified isolated time period, without causing device failure.
Varistor voltage:	Voltage across the varistor measured at 1mA DC current.	Maximum Clamping Voltage:	Maximum peak voltage across the varistor measured at a specified pulse current and waveform.
Rated Peak Single Pulse Transient Current:	Maximum peak current which may be applied for a single 8 x 20 $\mu$ s impulse, with maximum continuous applied voltage present, without causing device failure.	Response time:	The time between the point at which an applied impulse exceeds the clamping voltage level and the peak of the voltage overshoot.
Rated Single Pulse Transient Energy:	Energy which may be dissipated for a single impulse of maximum rated current, with maximum continuous applied voltage present, without causing device failure.		

**Stability Under Environmental Conditions:**

SIOV - Varistors, being constructed from a ceramic material, are inherently rugged. Although not hermetically sealed, the varistor is coated with a durable epoxy compound highly resistant to humidity.

A series of tests have been conducted to show the effect of environment on varistor voltage (measured at 1 mA). These are shown graphically in Figs. 1, 2, and 3; the vertical bars bracketing the trend line show the total variation of the tested populations.

Fig. 1 shows the effects of high-temperature storage at 125°C on varistor voltage: an average change of less than 2% is noted.

During storage at 40°C and 95% relative humidity for 1500 hours, varistor voltage changes less than 1% on average, as shown in Fig. 2.

Fig. 3 demonstrates the varistor's stability with rated voltage applied, under the same environmental conditions as Fig. 2. After 1344 hours (56 days), varistor voltage decreases only about 2% on average.

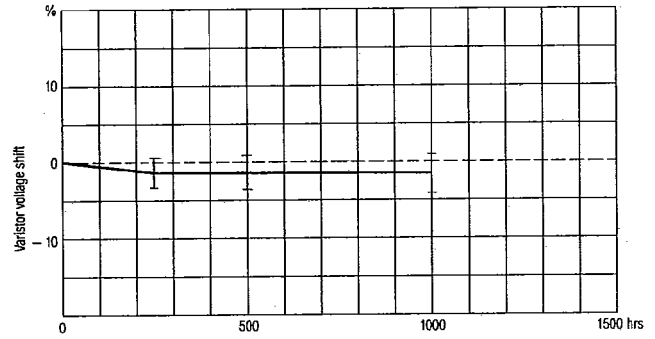

Figure 1 High-temperature storage at +125°C

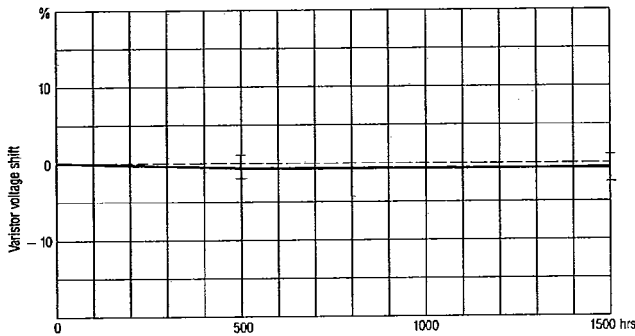

Figure 2 Storage at 40°C, 95% R.H.

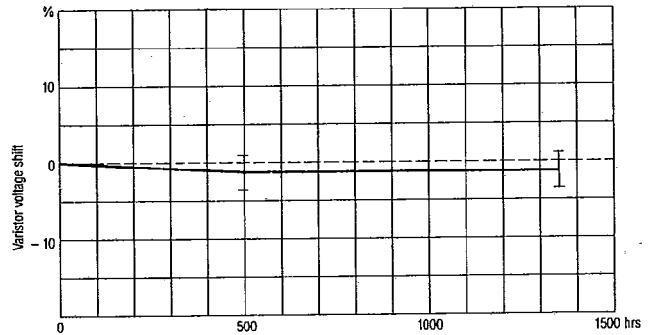

Figure 3 Operation with max. rated voltage at 40°C, 95% R.H.

**SIOV Environmental and Mechanical Ratings**

Parameter	Condition	Results
Lead Pull Strength	Specified load applied for 10 secs.: Lead                      Load 0.6mm                    0.5kg 0.8mm                    1.0kg 1.0mm                    2.0kg	No damage
Lead Bending Strength	3 bends, 90°, with specified load: Lead Dia.                Load 0.6mm                    0.25kg 0.8mm                    0.5kg 1.0mm                    1.0kg	No damage
Soldering Heat Resistance	3 seconds immersion in 350°C solder bath to a point 3mm from body	No damage; $\frac{\Delta V}{V_0} \leq 5\%$
Solderability	3 seconds immersion in 260°C solder bath to a point 3mm from body	At least 95% coverage
Vibration	1.5mm total excursion over 10-55Hz (1 minute sweep) for 2 hours each axis	No damage
High Temp. Storage	disc types: 125°C block types: 110°C for 1,000 hours	$\frac{\Delta V}{V_0} \leq 5\%$
High Temp. Operation	1000 hrs. at 85°C with max. allowable voltage applied	$\frac{\Delta V}{V_0} \leq 5\%$
Thermal Shock	5 cycles, -25°C, to +85°C	$\frac{\Delta V}{V_0} \leq 5\%$
Humidity	1000 hrs. at 40°C, 90-95% R.H.	$\frac{\Delta V}{V_0} \leq 5\%$
Flammability of Coating	Flame retardant per UL 94V-0	
Insulation of Breakdown Voltage	2.5 kV min.	

## Specifications

Part Number	Rated voltage		Varistor voltage ( $\pm 10\%$ ) Volts	Rated peak single pulse transient current Amps	Rated single pulse transient energy Joules	Rated transient average power dissipation Watts	Maximum clamping voltage Volts	Typical capacitance Picofarads
	AC Volts (RMS)	DC Volts						
S05K11	11	14	18	100	0.3	0.1	47@5A	1600
S07K11				250	0.7	0.25	39@5A	3500
S10K11				500	1.8	0.4	40@10A	7500
S14K11				1000	3.4	0.6	36@10A	18000
S20K11				2000	80†	1.0	36@20A	37000
S05K14	14	18*	22	100	0.3	0.1	56@5A	1300
S07K14				250	0.8	0.25	47@5A	2800
S10K14				500	2.1	0.4	48@10A	6000
S14K14				1000	4.0	0.6	42@10A	15000
S20K14				2000	100†	1.0	44@20A	30000
S05K17	17	22	27	100	0.4	0.1	72@5A	1050
S07K17				250	1.0	0.25	58@5A	2000
S10K17				500	2.6	0.4	58@10A	4000
S14K17				1000	5.0	0.6	52@10A	10000
S20K17				2000	120†	1.0	54@20A	22000
S05K20	20	27	33	100	0.5	0.1	86@5A	900
S07K20				250	1.2	0.25	70@5A	1500
S10K20				500	3.2	0.4	70@10A	3000
S14K20				1000	6.0	0.6	65@10A	7500
S20K20				2000	150†	1.0	67@20A	17000
S05K25	25	31	39	100	0.6	0.1	102@5A	500
S07K25				250	1.5	0.25	85@5A	1350
S10K25				500	3.8	0.4	85@10A	2600
S14K25				1000	7.2	0.6	75@10A	6500
S20K25				2000	160†	1.0	80@20A	15000
S05K30	30	38	47	100	0.7	0.1	127@5A	450
S07K30				250	1.7	0.25	100@5A	1150
S10K30				500	4.4	0.4	100@10A	2200
S14K30				1000	8.8	0.6	90@10A	5500
S20K30				2000	34	1.0	95@20A	13000
S05K35	35	45	56	100	0.9	0.1	143@5A	400
S07K35				250	2.1	0.25	120@5A	950
S10K35				500	5.6	0.4	120@10A	1800
S14K35				1000	10	0.6	110@10A	4500
S20K35				2000	38	1.0	110@20A	11000
S05K40	40	56	68	100	1.1	0.1	175@5A	350
S07K40				250	2.5	0.25	148@5A	700
S10K40				500	6.8	0.4	145@10A	1300
S14K40				1000	13	0.6	135@10A	3300
S20K40				2000	46	1.0	140@20A	7000
S05K50	50	66	82	400	1.8	0.1	143@5A	300
S07K50				1200	6.7	0.25	132@5A	700
S10K50				2500	15	0.4	130@10A	1200
S14K50				4500	27	0.6	125@10A	2500
S20K50				6500	36	1.0	125@20A	5000
S05K60	60	85	100	400	2.2	0.1	172@5A	280
S07K60				1200	8.2	0.25	160@5A	500
S10K60				2500	20	0.4	160@10A	1100
S14K60				4500	30	0.6	155@10A	2100
S20K60				6500	45	1.0	155@20A	4200
S05K75	75	102	120	400	2.6	0.1	210@5A	250
S07K75				1200	10	0.25	200@10A	450
S10K75				2500	24	0.4	215@50A	900
S14K75				4500	38	0.6	200@50A	1400
S20K75				6500	55	1.0	200@100A	2900
B40K75				25000	415	2.0	225@1000A	15000
B60K75				70000	700	2.5	215@1000A	28000

\*S20K14 will withstand 24 VDC for 5 minutes.

†Energy rating for impulse duration of 30 ms minimum to one-half of peak current value, and a maximum shift of  $\pm 10\%$  of initial value of varistor voltage measured at 10mA DC.

**A-11-09**

**Specifications, cont.**

Part Number	Rated voltage		Varistor voltage (± 10%) Volts	Rated peak single pulse transient current Amps	Rated single pulse transient energy Joules	Rated transient average power dissipation Watts	Maximum clamping voltage Volts	Typical capacitance Picofarads
	AC Volts (RMS)	DC Volts						
S05K95	95	127	150	400	3.2	0.1	260@5A	230
S07K95				1200	12	0.25	250@10A	350
S10K95				2500	26	0.4	270@50A	650
S14K95				4500	45	0.6	250@50A	1200
S20K95				6500	65	1.0	250@100A	2200
S05K130	130	175	205	400	4.2	0.1	355@5A	180
S07K130				1200	15	0.25	340@10A	300
S10K130				2500	32	0.4	365@50A	540
S14K130				4500	55	0.6	340@50A	900
S20K130				6500	80	1.0	340@100A	1800
B32K130				25000	350	1.5	350@300A	7500
B40K130				40000	520	2.0	380@1000A	9000
B60K130				70000	770	2.5	370@1000A	16500
S05K140	140	185	220	400	4.4	0.1	375@5A	170
S07K140				1200	15	0.25	360@10A	270
S10K140				2500	36	0.4	385@50A	500
S14K140				4500	60	0.6	370@50A	850
S20K140				6500	90	1.0	360@100A	1500
S05K150	150	200	240	400	5.0	0.1	425@5A	150
S07K150				1200	17	0.25	400@10A	240
S10K150				2500	40	0.4	420@50A	400
S14K150				4500	65	0.6	395@50A	800
S20K150				6500	95	1.0	395@100A	1400
B32K150				25000	425	1.5	410@300A	6000
B40K150				40000	680	2.0	430@1000A	7500
B60K150				70000	1120	2.5	420@1000A	14000
S05K175	175	225	270	400	5.6	0.1	475@5A	130
S07K175				1200	19	0.25	460@10A	220
S10K175				2500	43	0.4	485@50A	350
S14K175				4500	68	0.6	460@50A	700
S20K175				6500	110	1.0	455@100A	1300
S05K230	230	300	360	400	7.2	0.1	630@5A	110
S07K230				1200	25	0.25	600@10A	160
S10K230				2500	50	0.4	640@50A	300
S14K230				4500	85	0.6	610@50A	500
S20K230				6500	130	1.0	595@100A	1000
B32K230				25000	650	1.5	610@300A	5000
B40K230				40000	1200	2.0	670@1000A	4800
B60K230				70000	1960	2.5	650@1000A	9200
S05K250	250	330	290	400	7.6	0.1	675@5A	100
S07K250				1200	26	0.25	650@10A	150
S10K250				2500	55	0.4	700@50A	270
S14K250				4500	92	0.6	650@50A	460
S20K250				6500	140	1.0	650@100A	900
B32K250				25000	800	1.5	680@300A	3500
B40K250				40000	1440	2.0	730@1000A	4500
B60K250				70000	2300	2.5	710@1000A	8500
S05K275	275	370	430	400	8.4	0.1	750@5A	85
S07K275				1200	28	0.25	700@10A	130
S10K275				2500	60	0.4	770@50A	250
S14K275				4500	100	0.6	710@50A	410
S20K275				6500	150	1.0	710@100A	750
B32K275				25000	950	1.5	770@300A	3200
B40K275				40000	1680	2.0	815@1000A	4000
B60K275				70000	2520	2.5	800@1000A	7500

5-11-25

A-11-09

Specifications, cont.

Part Number	Rated voltage		Varistor voltage (± 10%) Volts	Rated peak single pulse transient current Amps	Rated single pulse transient energy Joules	Rated transient average power dissipation Watts	Maximum clamping voltage Volts	Typical capacitance Picofarads
	AC Volts (RMS)	DC Volts						
S05K300	300	405	470	400	10	0.1	835@5A	80
S07K300				1200	32	0.25	800@10A	120
S10K300				2500	65	0.4	850@50A	230
S14K300				4500	110	0.6	800@50A	400
S20K300				6500	160	1.0	775@100A	700
S10K385	385	505	620	2500	80	0.4	1070@50A	170
S14K385				4500	140	0.6	1025@50A	300
S20K385				6500	220	1.0	1025@100A	600
B32K385				25000	1100	1.5	1100@300A	2300
B40K385				40000	1960	2.0	1150@1000A	3000
B60K385				70000	3360	2.5	1130@1000A	5500
S10K420	420	560	680	2500	85	0.4	1180@50A	160
S14K420				4500	150	0.6	1120@50A	280
S20K420				6500	230	1.0	1120@100A	580
B32K420				25000	1250	1.5	1200@300A	2100
B40K420				40000	2200	2.0	1250@1000A	2800
B60K420				70000	3500	2.5	1230@1000A	5000
S10K460	460	615	750	2500	95	0.4	1290@50A	140
S14K460				4500	170	0.6	1240@50A	250
S20K460				6500	260	1.0	1240@100A	500
B32K460				25000	1400	1.5	1350@300A	1900
B40K460				40000	2400	2.0	1350@1000A	2400
B60K460				70000	3920	2.5	1330@1000A	4400
S10K510	510	675	820	2500	100	0.4	1420@50A	130
S14K510				4500	185	0.6	1355@50A	240
S20K510				6500	280	1.0	1355@100A	470
S10K550	550	745	910	2500	110	0.4	1850@50A	120
S14K550				4500	200	0.6	1500@50A	220
S20K550				6500	300	1.0	1500@100A	450
B32K550				25000	1750	1.5	1600@300A	1600
B40K550				40000	3000	2.0	1720@1000A	2000
B60K550				70000	4480	2.5	1700@1000A	3700
S10K625	625	825	1000	2500	120	0.4	2020@50A	100
S14K625				4500	210	0.6	1650@50A	200
S20K625				6500	330	1.0	1650@100A	400
S10K680	680	895	1100	2500	135	0.5	2200@50A	90
S14K680				4500	225	0.6	1815@50A	190
S20K680				6500	365	1.0	1815@100A	330
B32K680				25000	2100	1.5	1850@300A	1500
B40K680				40000	3300	2.0	2090@1000A	1800
B60K680				70000	5300	2.5	2070@1000A	3200
B40K750	750	1060	1200	40000	3600	2.0	2350@1000A	1600
B60K750				70000	6100	2.5	2320@1000A	2600
S14K1000	1000	1465	1800	4500	360	0.6	2970@50A	100
S20K1000				6500	500	1.0	2970@100A	200
B60K1000				70000	10300	2.5	3180@1000A	2000

7-11-25  
A-11-09

**VI Characteristics**

The V-I characteristics are shown for the various series described. In actual operation the idle power (no transient condition) is of importance; therefore, for each of the series described, the maximum leakage current is shown (to the left of the discontinuity). During transient operation, the clamp-

ing voltage for a given current is of importance; therefore, for each of the series described, the maximum clamping voltage for a given surge current value is shown (to the right of the discontinuity).

v S05K11...300

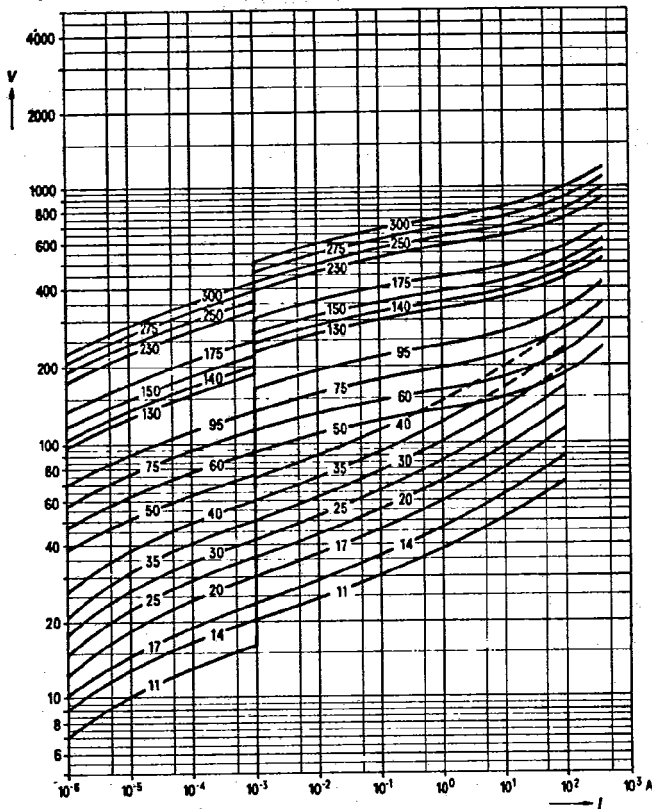

v S07K11...300

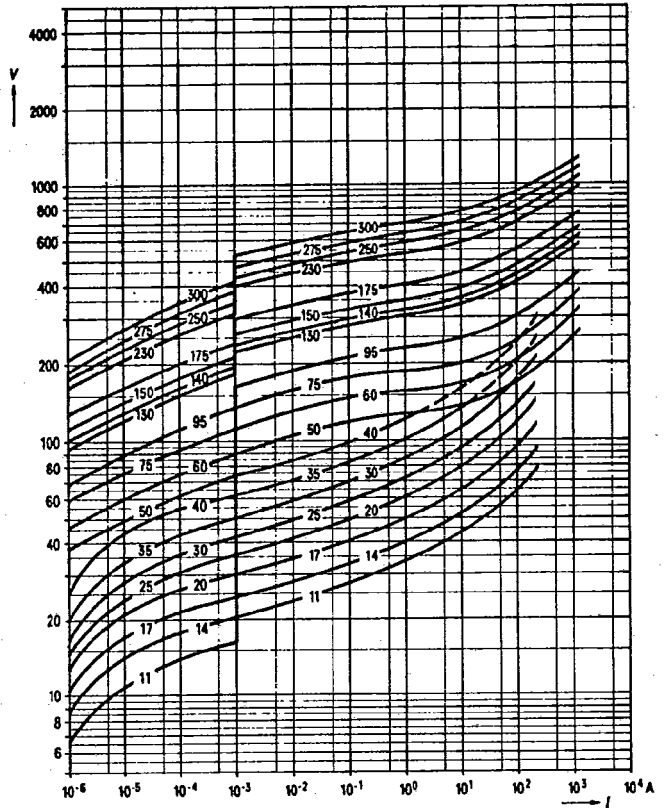

v S10K11...680

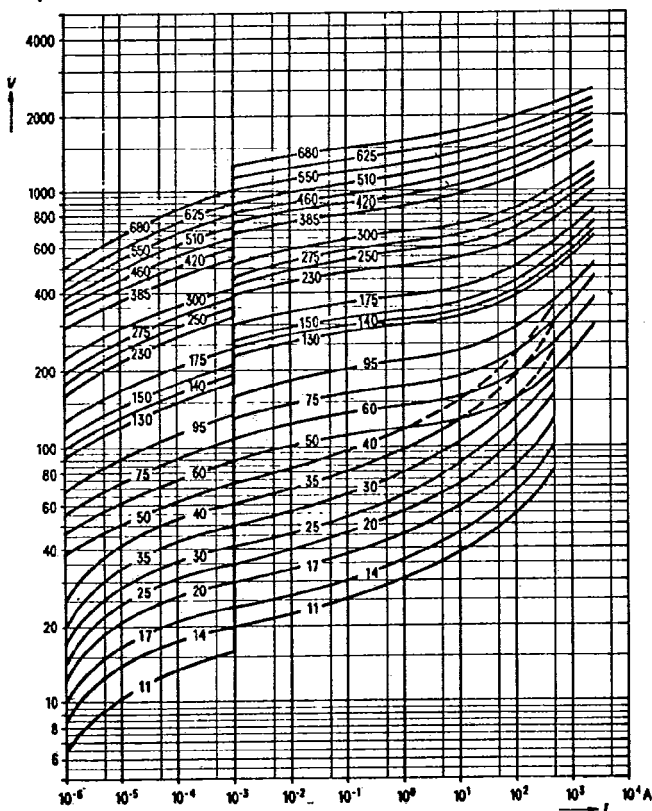

v S14K11...1000

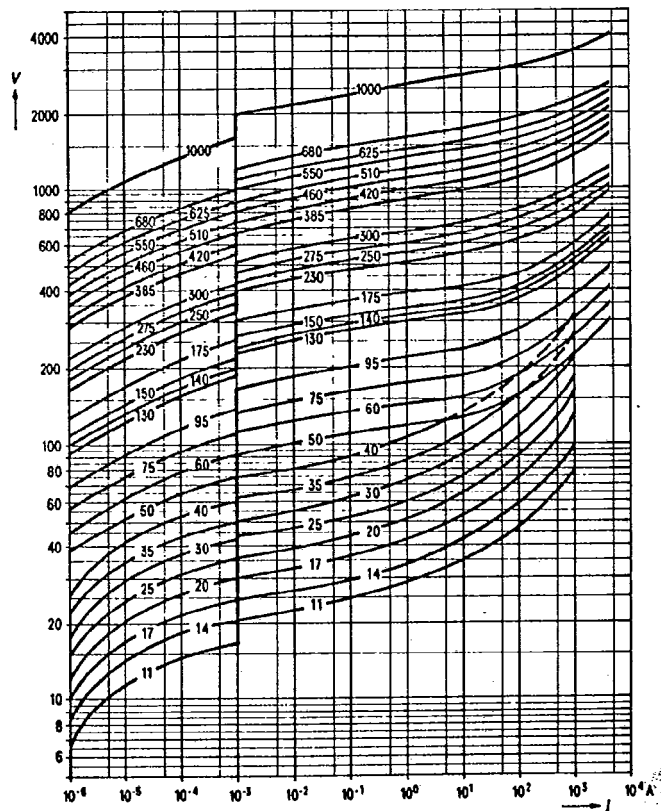

7-11-25

A-11-09

V-I Characteristics, cont.

v S20K11...1000

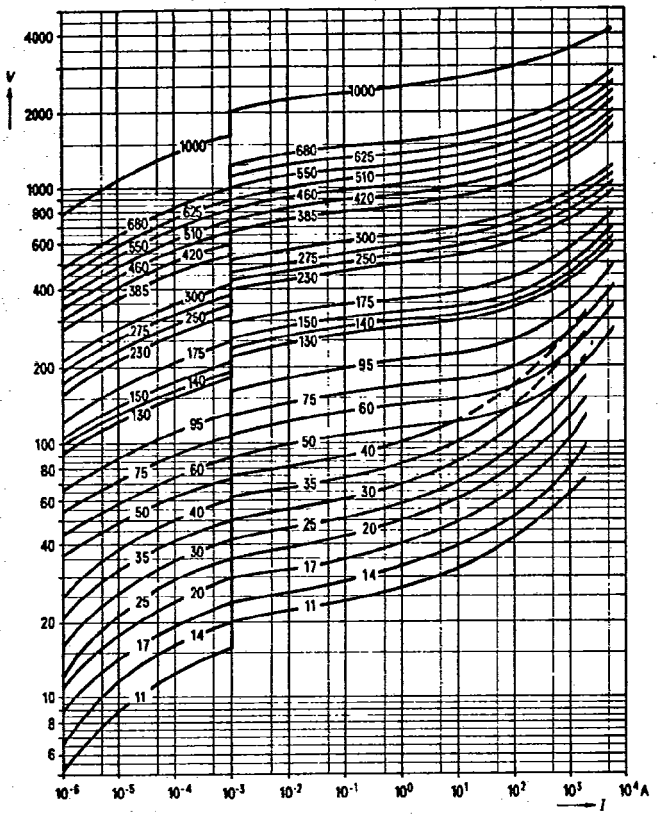

v B32K130...750

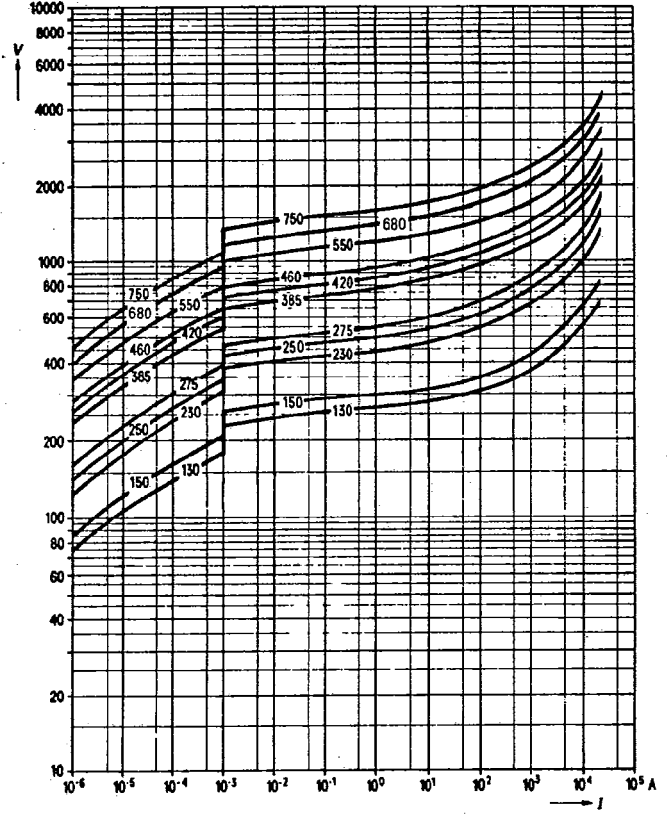

v B40K75...750

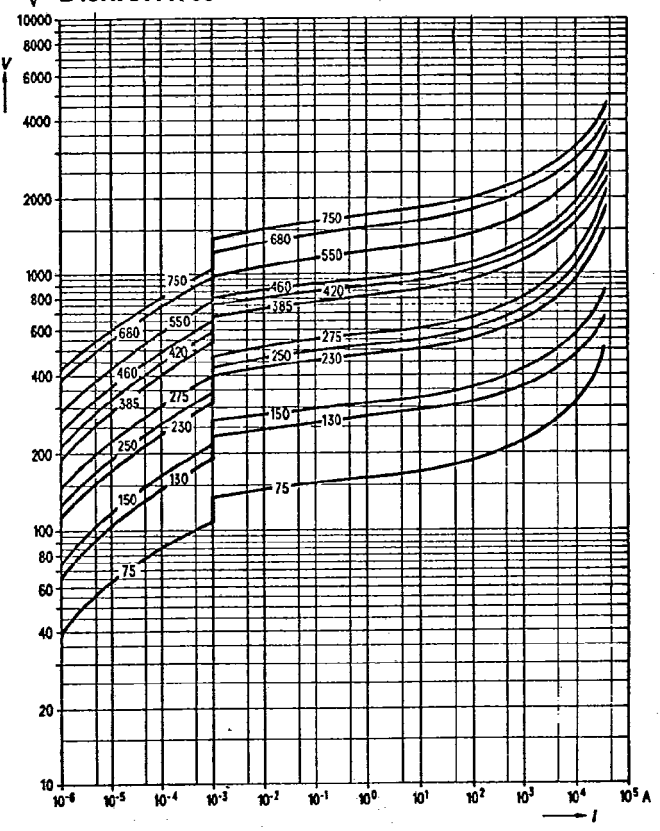

v B60K75...1000

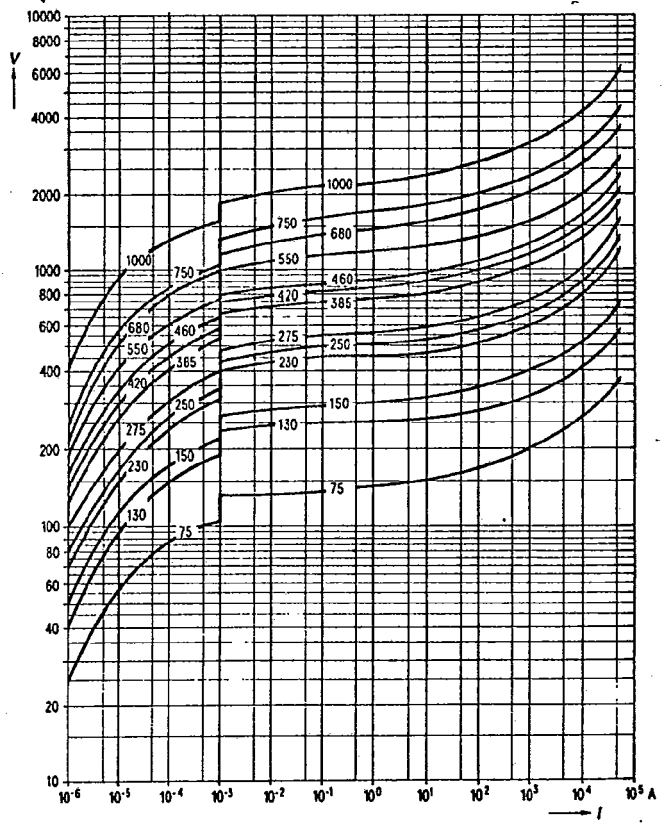



7-11-25  
A-11-09

**Surge Lifetime Ratings** (Relation between Impulse width and number of repetitions)

The curves on pages 11 through 16 are used to determine the maximum number of times a varistor can withstand a current impulse of a given peak amplitude and pulse width (rectangular pulse width is assumed) without a change in varistor voltage of more than 10 percent. If these lifetime ratings are exceeded, the varistor voltage may undergo a permanent change of greater than 10 percent, which may lead to catastrophic failure under some circumstances. For this reason, the varistor safety recommendations listed on page 19 should be followed.

**A S05K11...40**

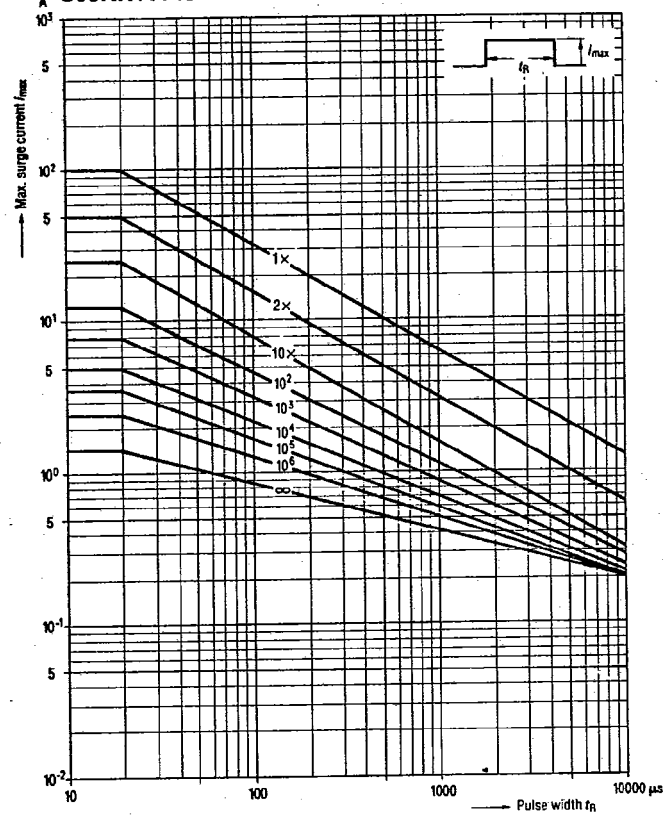

**A S05K50...300**

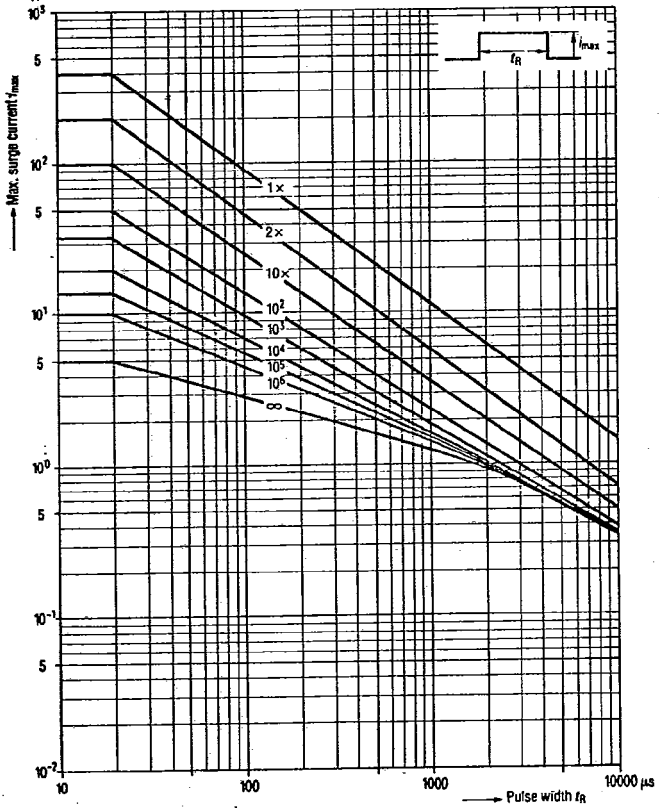

**A S07K11...40**

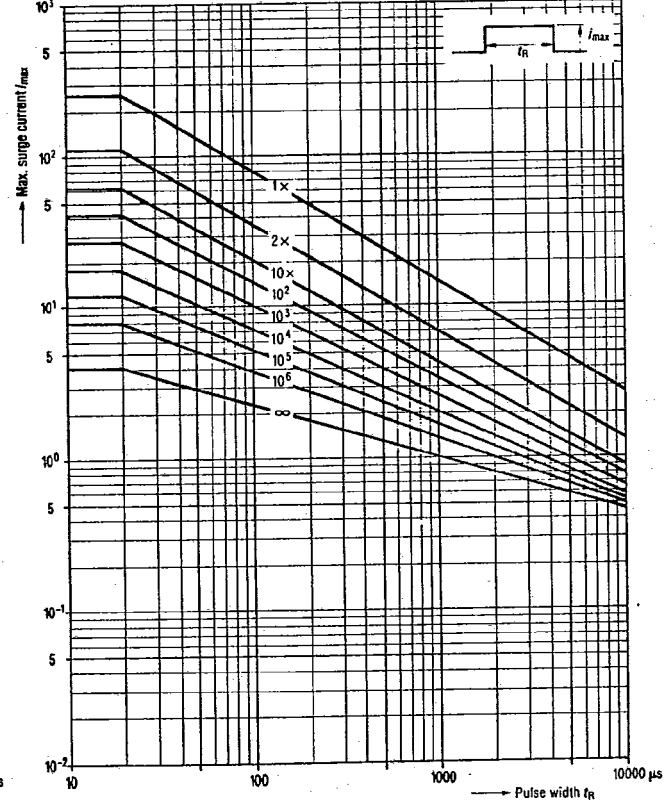

Surge Lifetime Ratings, cont.

A-11-09

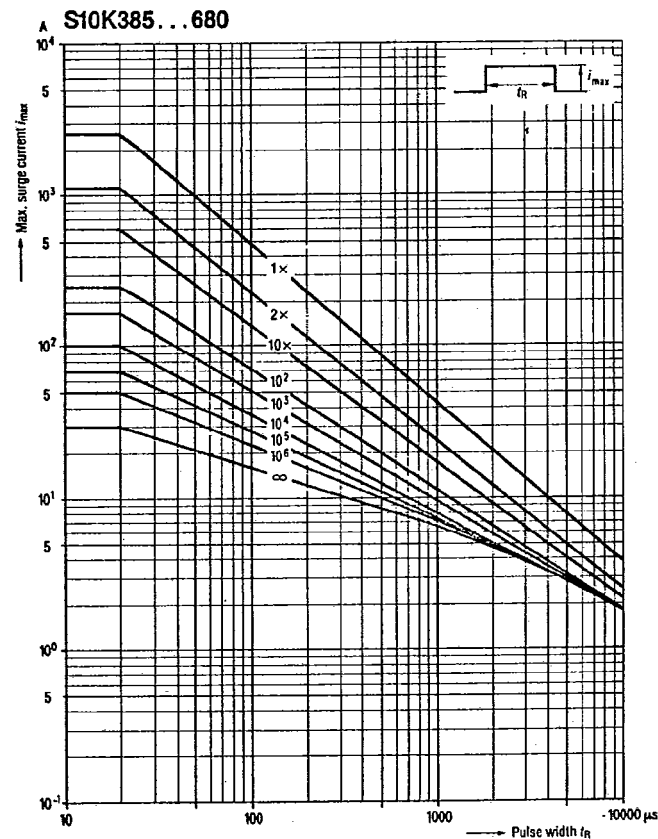
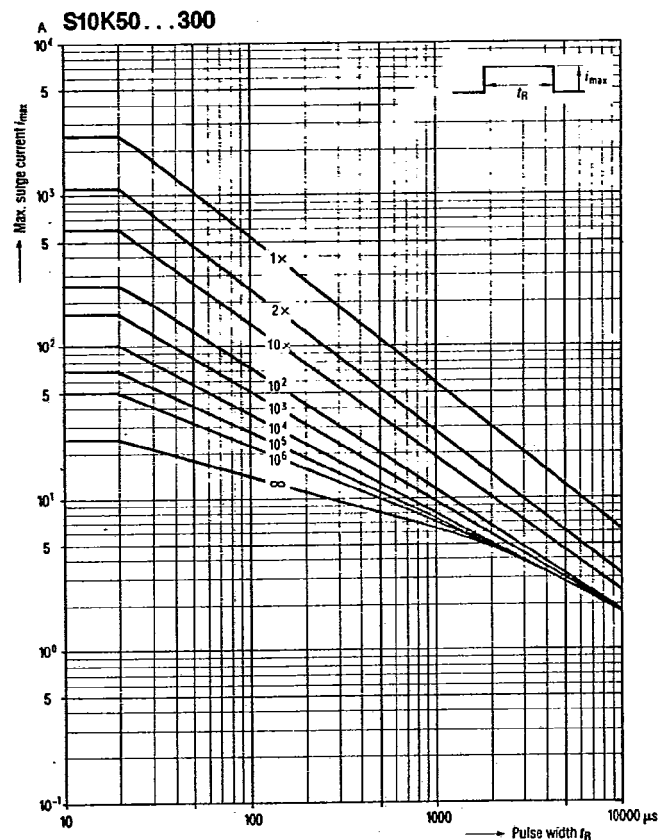
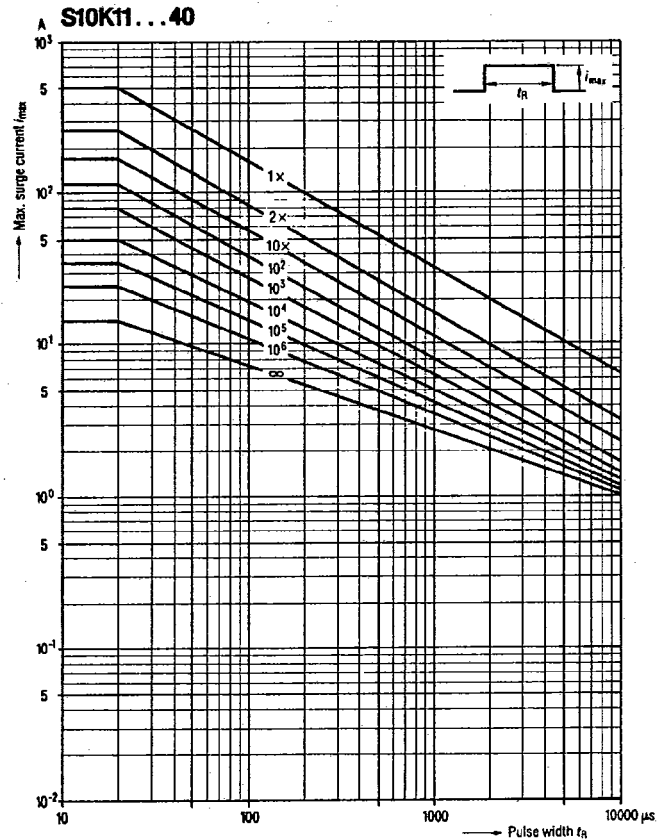
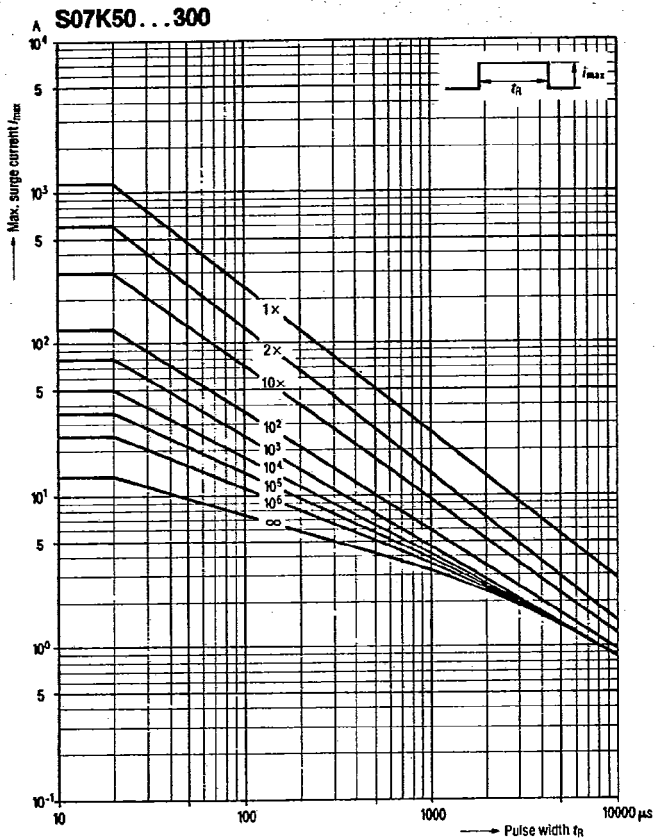

TH1125  
A-11-09

Surge Lifetime Ratings, cont.

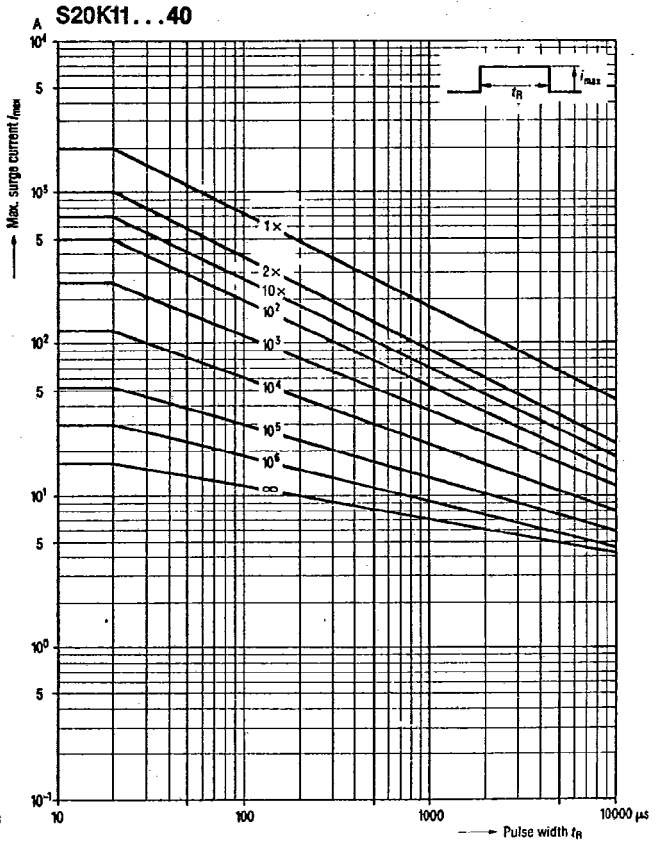
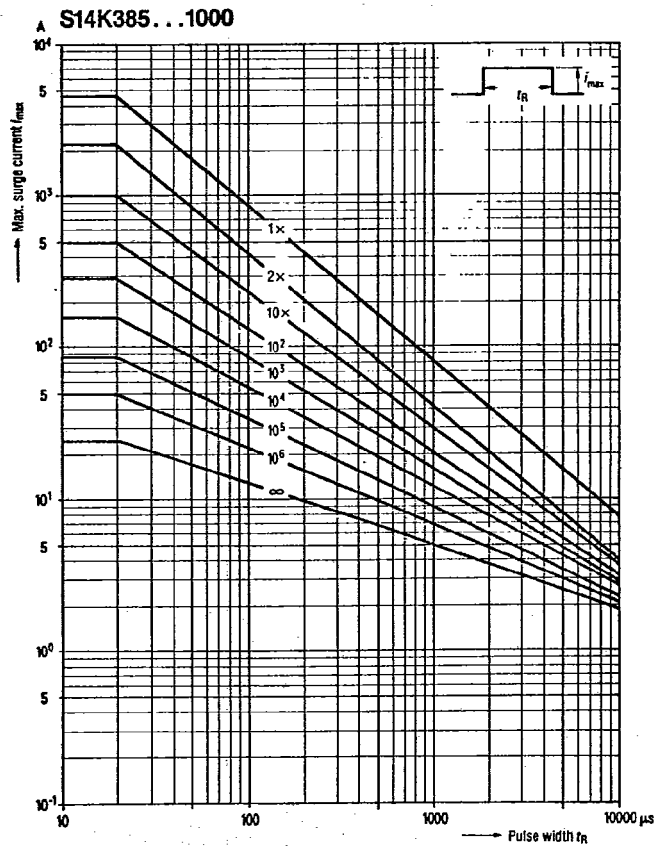
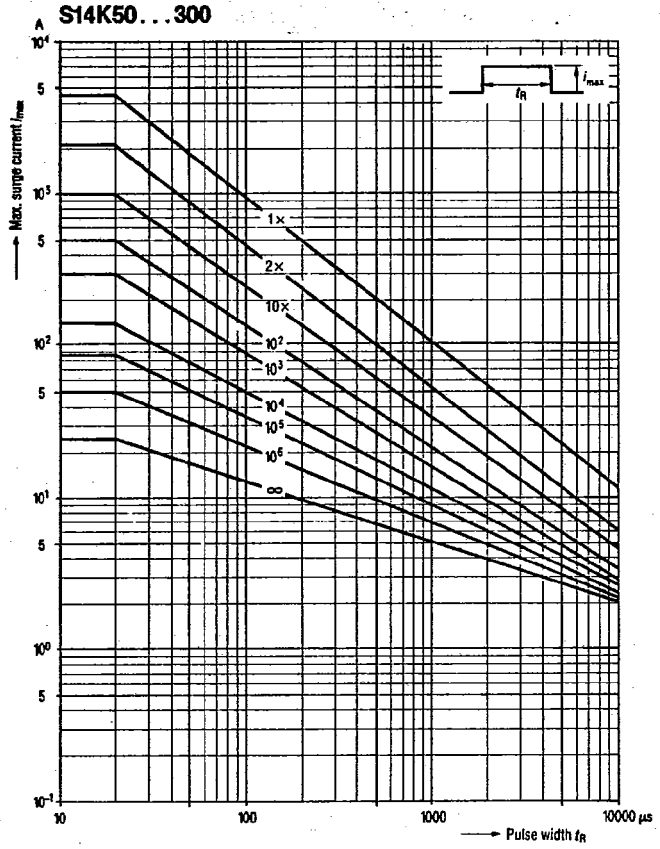
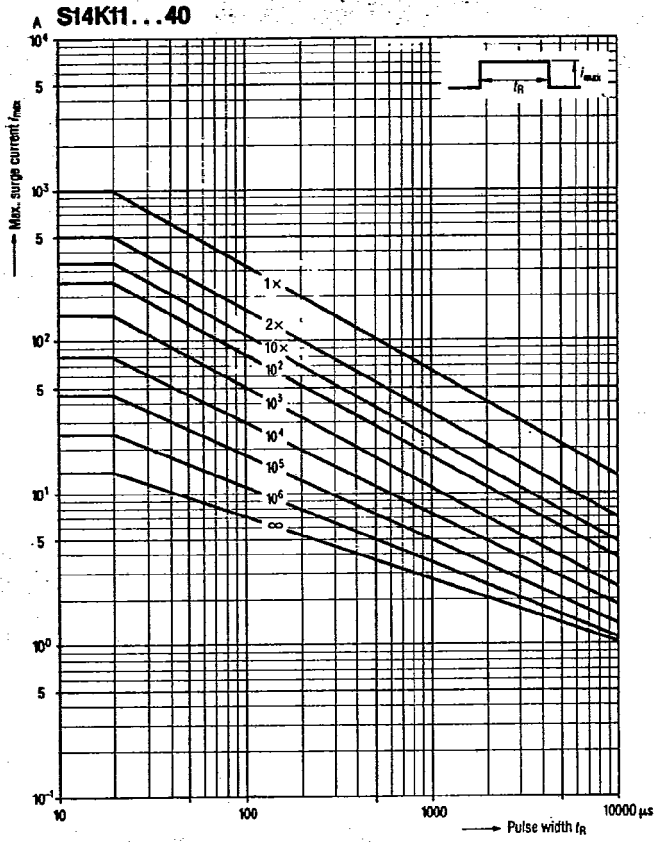

17-11-25  
A-11-09

Surge Lifetime Ratings, cont.

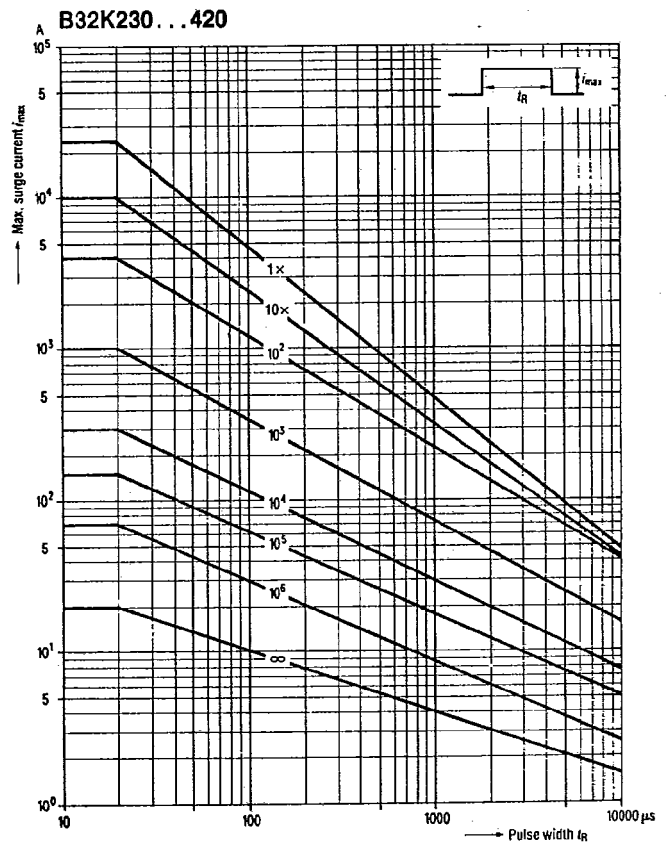
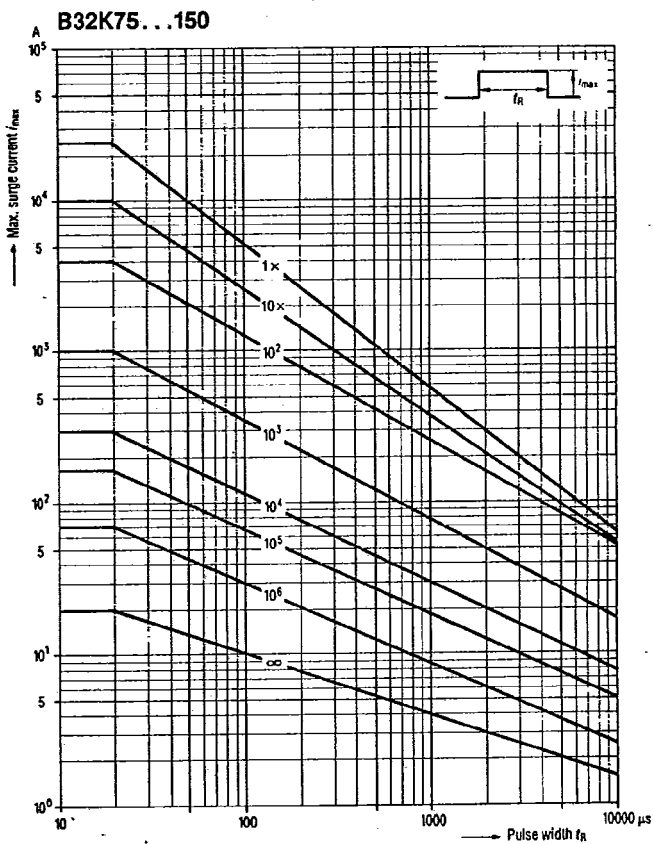
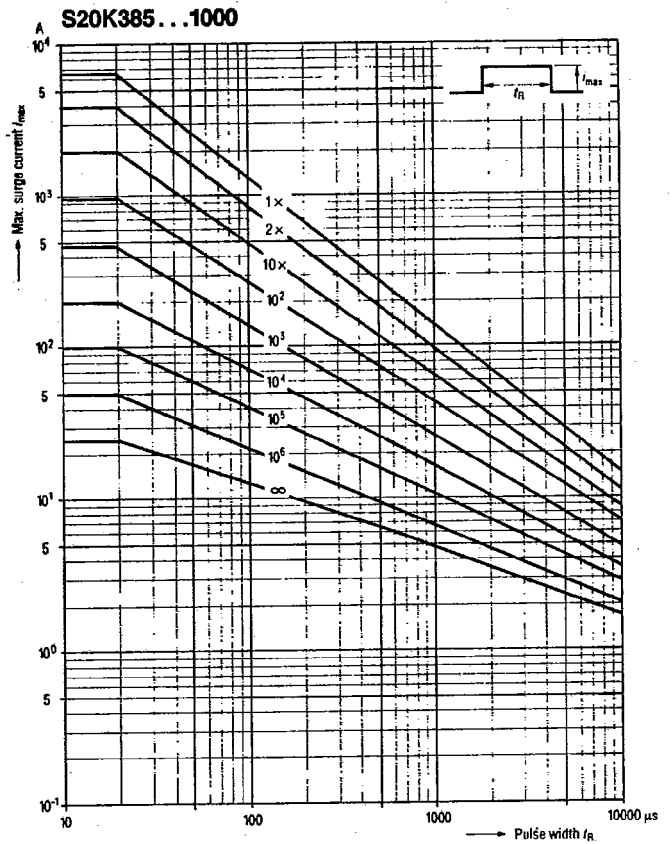
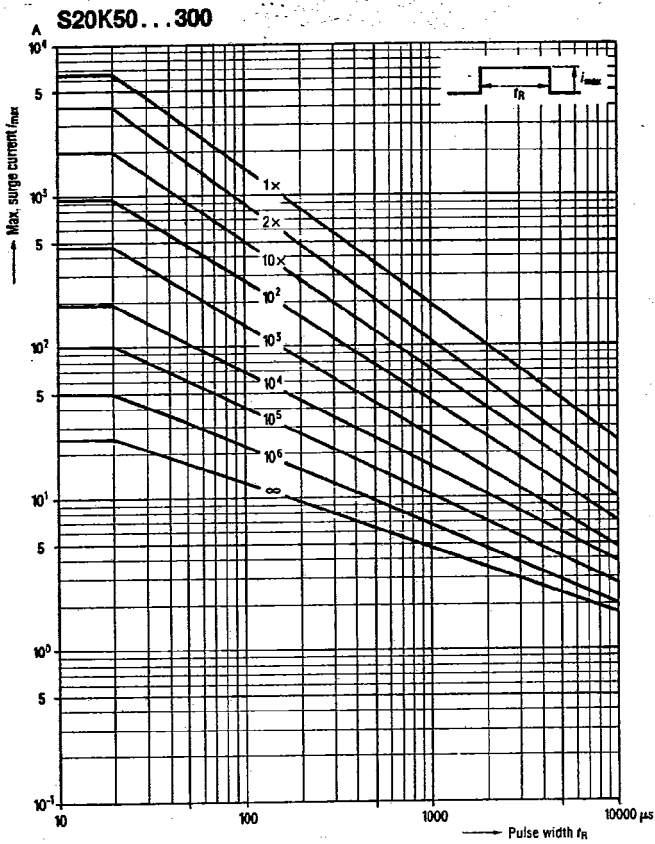

Surge Lifetime Ratings, cont.

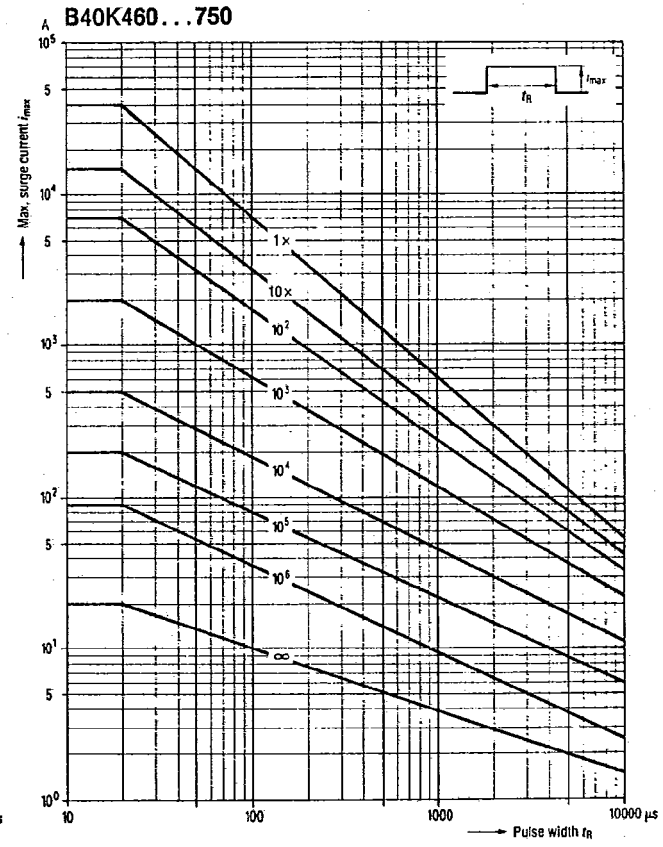
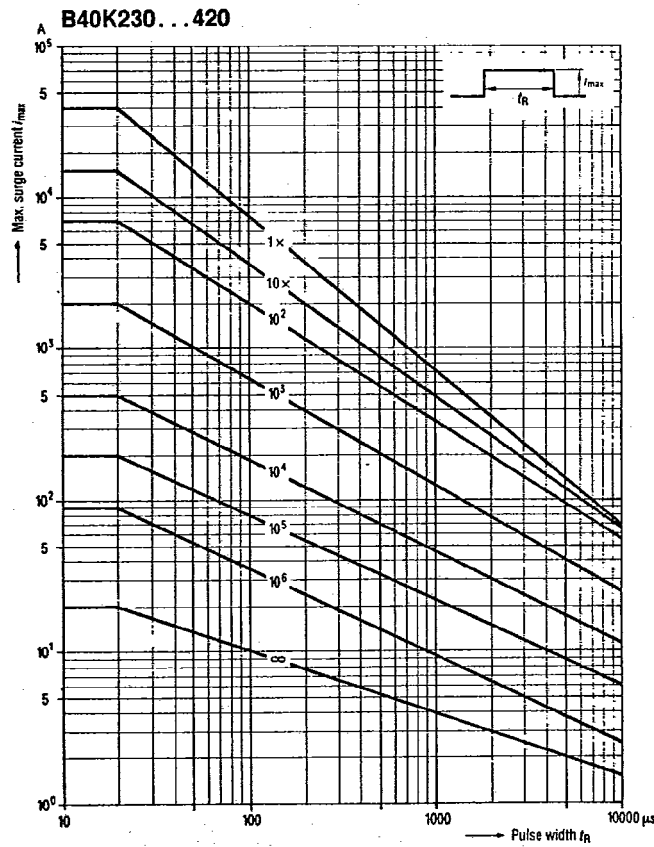
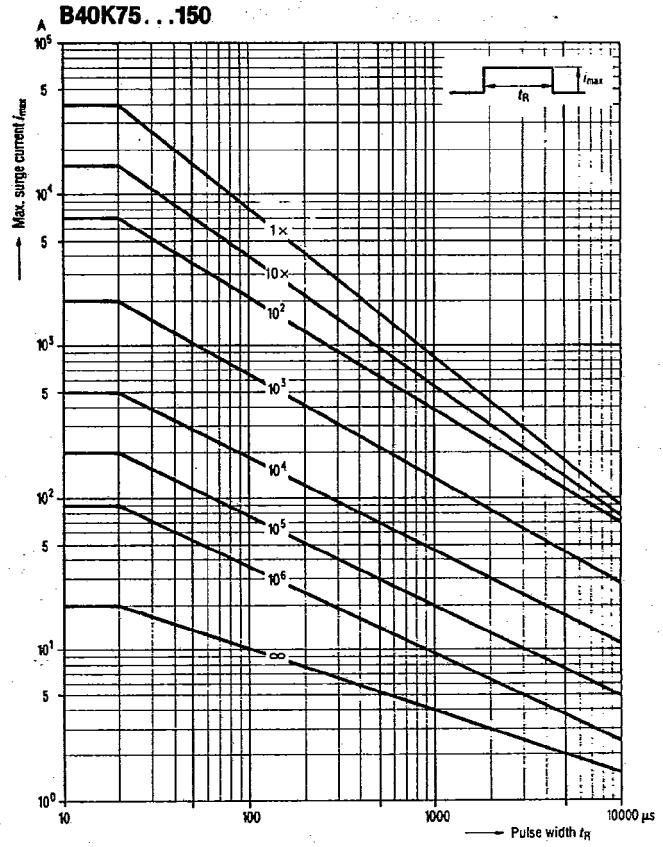
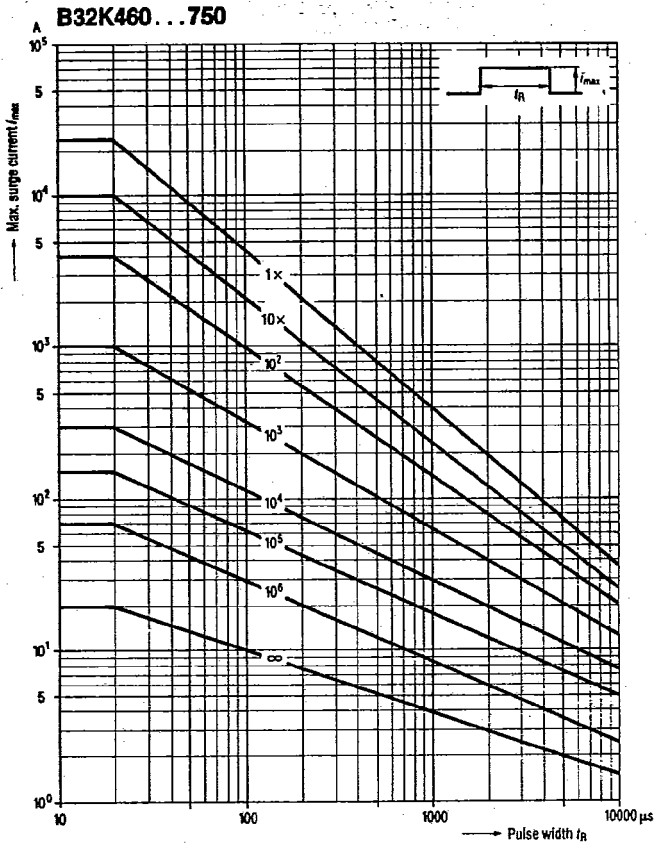

Surge Lifetime Ratings, cont.

A-11-09

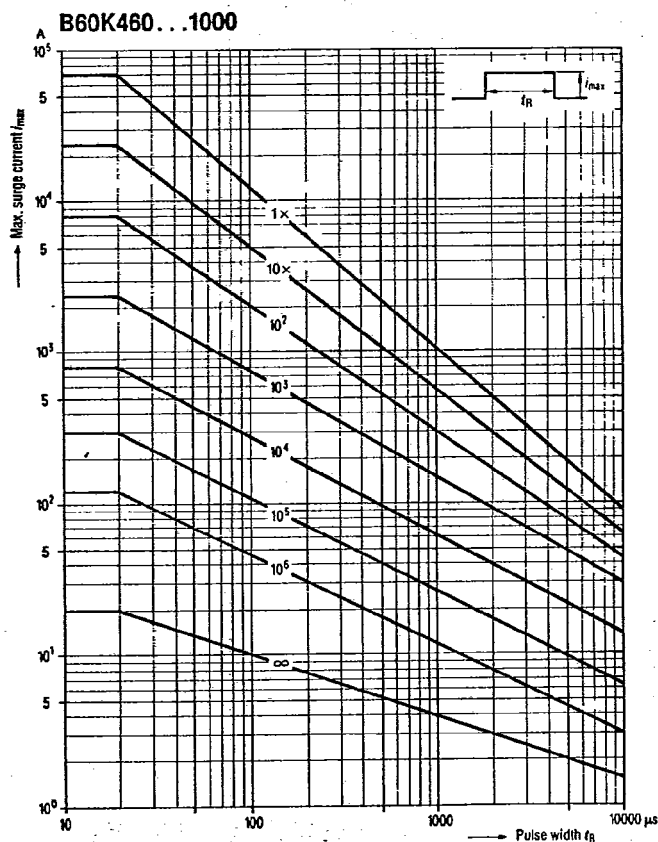
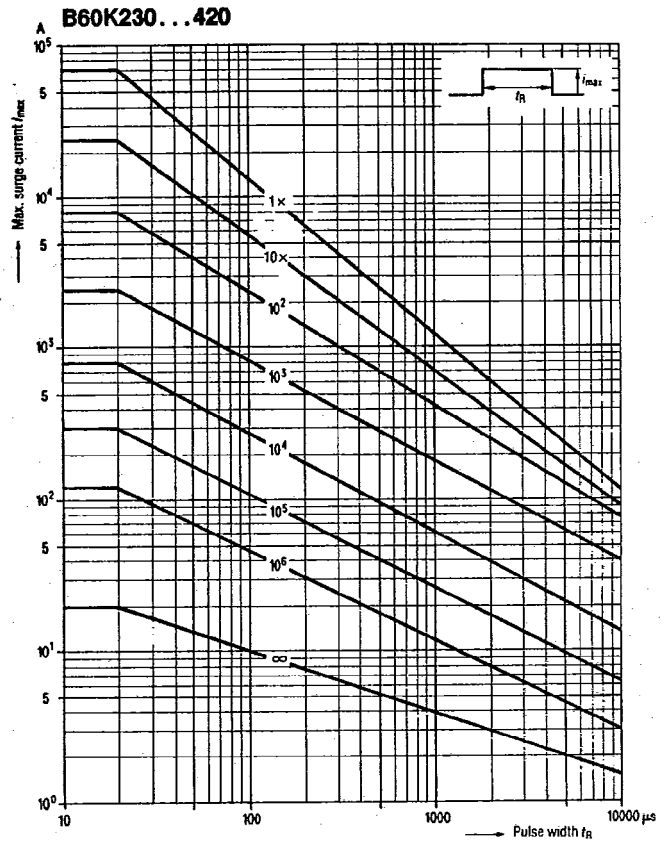
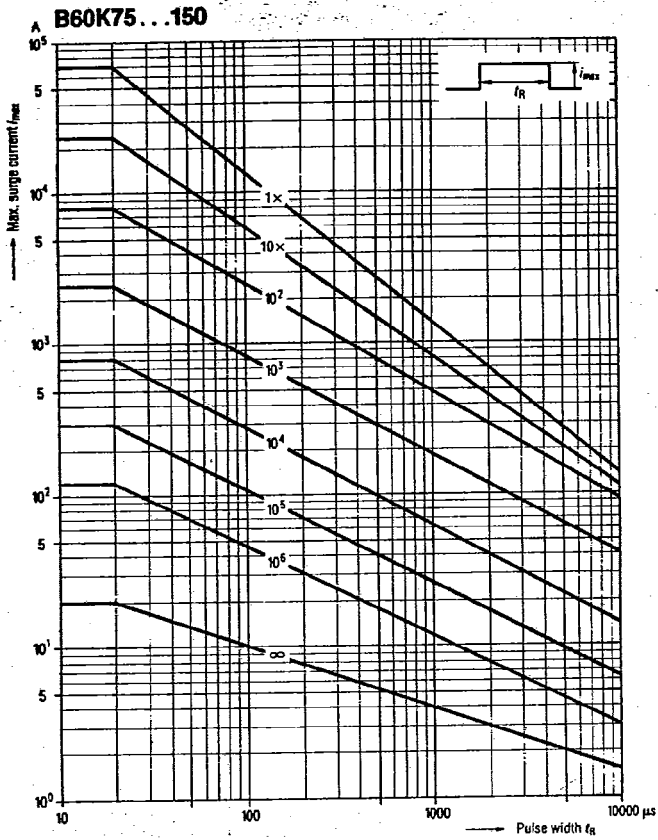

7-11-25  
A-11-09

**Outline Dimensions**

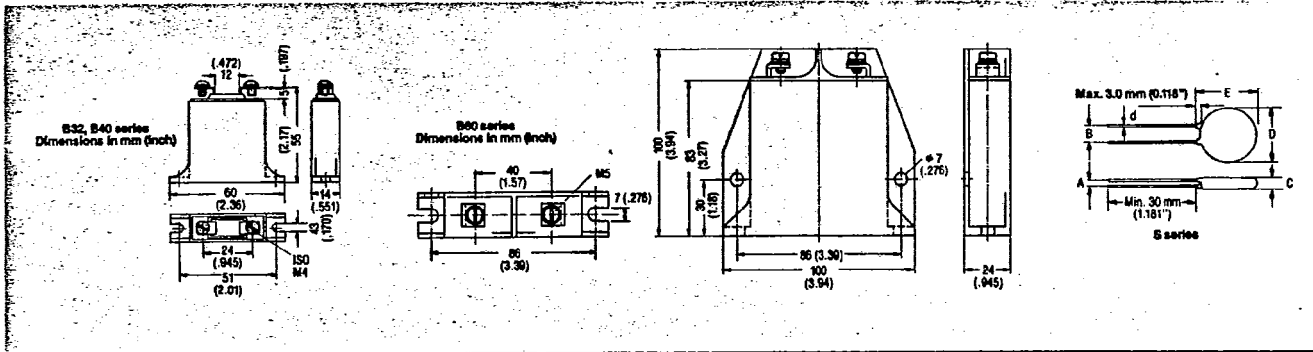

Part Number	D max.		C max.		B*		E max.		A*		d	
	inch	mm	inch	mm	inch	mm	inch	mm	inch	mm		
S05K11	0.295	7.5	0.177	4.5	0.197	5.0	0.394	10.0	0.059	1.5	0.024	0.6
S05K14	↑	↑	↑	↑	↑	↑	↑	↑	↑	↑	↑	↑
S05K17	↑	↑	↑	↑	↑	↑	↑	↑	↑	↑	↑	↑
S05K20	↑	↑	↑	↑	↑	↑	↑	↑	↑	↑	↑	↑
S05K25	↑	↑	↑	↑	↑	↑	↑	↑	↑	↑	↑	↑
S05K30	↑	↑	↑	↑	↑	↑	↑	↑	↑	↑	↑	↑
S05K35	↑	↑	↑	↑	↑	↑	↑	↑	↑	↑	↑	↑
S05K40	↑	↑	↑	↑	↑	↑	↑	↑	↑	↑	↑	↑
S05K50	0.295	7.5	0.177	4.5	↑	↑	↑	↑	0.059	1.5	↑	↑
S05K60	0.276	7.0	0.185	4.7	↑	↑	↑	↑	0.063	1.6	↑	↑
S05K75	↑	↑	0.189	4.8	↑	↑	↑	↑	0.071	1.8	↑	↑
S06K95	↑	↑	0.197	5.0	↑	↑	↑	↑	0.079	2.0	↑	↑
S05K130	↑	↑	0.205	5.2	↑	↑	↑	↑	0.079	2.0	↑	↑
S05K140	↑	↑	0.209	5.3	↑	↑	↑	↑	0.083	2.1	↑	↑
S05K150	↑	↑	0.213	5.4	↑	↑	↑	↑	0.087	2.2	↑	↑
S05K175	↑	↑	0.220	5.6	↑	↑	↑	↑	0.094	2.4	↑	↑
S05K230	↑	↑	0.244	6.2	↑	↑	↑	↑	0.118	3.0	↑	↑
S05K250	↑	↑	0.252	6.4	↑	↑	↑	↑	0.126	3.2	↑	↑
S05K275	↑	↑	0.264	6.7	↑	↑	↑	↑	0.138	3.5	↑	↑
S05K300	0.276	7.0	0.276	7.0	↑	↑	0.394	10.0	0.150	3.8	↑	↑
S07K11	0.354	9.0	0.177	4.5	↑	↑	0.472	12.0	0.051	1.3	↑	↑
S07K14	↑	↑	0.181	4.6	↑	↑	↑	↑	0.055	1.4	↑	↑
S07K17	↑	↑	0.185	4.7	↑	↑	↑	↑	0.059	1.5	↑	↑
S07K20	↑	↑	0.193	4.9	↑	↑	↑	↑	0.067	1.7	↑	↑
S07K25	↑	↑	0.189	4.8	↑	↑	↑	↑	0.067	1.7	↑	↑
S07K30	↑	↑	0.193	4.9	↑	↑	↑	↑	0.071	1.8	↑	↑
S07K35	↑	↑	0.197	5.0	↑	↑	↑	↑	0.075	1.9	↑	↑
S07K40	↑	↑	0.205	5.2	↑	↑	↑	↑	0.083	2.1	↑	↑
S07K50	↑	↑	0.181	4.6	↑	↑	↑	↑	0.063	1.6	↑	↑
S07K60	↑	↑	0.185	4.7	↑	↑	↑	↑	0.063	1.6	↑	↑
S07K70	↑	↑	0.189	4.8	↑	↑	↑	↑	0.071	1.8	↑	↑
S07K95	↑	↑	0.197	5.0	↑	↑	↑	↑	0.079	2.0	↑	↑
S07K130	↑	↑	0.204	5.2	↑	↑	↑	↑	0.079	2.0	↑	↑
S07K140	↑	↑	0.209	5.3	↑	↑	↑	↑	0.083	2.1	↑	↑
S07K150	↑	↑	0.213	5.4	↑	↑	↑	↑	0.087	2.2	↑	↑
S07K175	↑	↑	0.220	5.6	↑	↑	↑	↑	0.094	2.4	↑	↑
S07K230	↑	↑	0.244	6.2	↑	↑	↑	↑	0.118	3.0	↑	↑
S07K250	↑	↑	0.252	6.4	↑	↑	↑	↑	0.126	3.2	↑	↑
S07K275	↑	↑	0.264	6.7	↑	↑	↑	↑	0.138	3.5	↑	↑
S07K300	0.354	9.0	0.276	7.0	0.197	5.0	0.472	12.0	0.150	3.8	0.024	0.6
S10K11	0.531	13.5	0.181	4.6	0.295	7.5	0.650	16.5	0.050	1.3	0.031	0.8
S10K14	↑	↑	0.185	4.7	↑	↑	↑	↑	0.055	1.4	↑	↑
S10K17	↑	↑	0.189	4.8	↑	↑	↑	↑	0.059	1.5	↑	↑
S10K20	↑	↑	0.197	5.0	↑	↑	↑	↑	0.067	1.7	↑	↑
S10K25	↑	↑	0.201	5.1	↑	↑	↑	↑	0.071	1.8	↑	↑
S10K30	↑	↑	0.197	5.0	↑	↑	↑	↑	0.071	1.8	↑	↑
S10K35	↑	↑	0.201	5.1	↑	↑	↑	↑	0.075	1.9	↑	↑
S10K40	↑	↑	0.209	5.3	↑	↑	↑	↑	0.087	2.2	↑	↑
S10K50	↑	↑	0.197	5.0	↑	↑	↑	↑	0.087	2.2	↑	↑
S10K60	↑	↑	0.201	5.1	↑	↑	↑	↑	0.071	1.8	↑	↑
S10K75	↑	↑	0.205	5.2	↑	↑	↑	↑	0.079	2.0	↑	↑
S10K95	↑	↑	0.217	5.5	↑	↑	↑	↑	0.087	2.2	↑	↑
S10K130	↑	↑	0.220	5.6	↑	↑	↑	↑	0.087	2.2	↑	↑
S10K140	↑	↑	0.224	5.7	↑	↑	↑	↑	0.091	2.3	↑	↑
S10K150	↑	↑	0.228	5.8	↑	↑	↑	↑	0.094	2.4	↑	↑
S10K175	0.531	13.5	0.240	6.1	0.295	7.5	0.650	16.5	0.102	2.6	0.031	0.8

## Outline Dimensions, cont.

A-11-09

Part Number	D max.		C max.		B*		E max.		A*		d	
	Inch	mm	Inch	mm	Inch	mm	Inch	mm	Inch	mm	Inch	mm
S10K130	0.551	14.0	0.264	6.7	0.295	7.5	0.669	17.0	0.126	3.2	0.031	0.8
S10K250			0.268	6.8					0.134	3.4		
S10K275			0.283	7.2					0.146	3.7		
S10K300			0.295	7.5					0.157	4.0		
S10K385			0.287	7.3					0.157	4.0		
S10K420									0.161	4.1		
S10K460			0.315	8.0					0.173	4.4		
S10K510			0.335	8.5					0.185	4.7		
S10K550			0.354	9.0					0.205	5.2		
S10K625			0.413	10.5					0.220	5.6		
S10K680	0.551	14.0	0.441	11.2			0.669	17.0	0.240	6.1		
S14K11	0.669	17.0	0.181	4.6			0.787	20.0	0.051	1.3		
S14K14			0.185	4.7					0.055	1.4		
S14K17			0.189	4.8					0.059	1.5		
S14K20			0.197	5.0					0.067	1.7		
S14K25			0.201	5.1					0.071	1.8		
S14K30			0.197	5.0					0.071	1.8		
S14K35			0.201	5.1					0.075	1.9		
S14K40			0.209	5.3					0.087	2.2		
S14K50			0.197	5.0					0.087	2.2		
S14K60			0.201	5.1					0.071	1.8		
S14K75			0.205	5.2					0.079	2.0		
S14K95			0.217	5.5					0.087	2.2		
S14K130			0.220	5.6					0.087	2.2		
S14K140			0.224	5.7					0.091	2.3		
S14K150			0.228	5.8					0.094	2.4		
S14K175	0.669	17.0	0.240	6.1			0.787	20.0	0.102	2.6		
S14K230	0.689	17.5	0.264	6.7			0.807	20.5	0.126	3.2		
S14K250			0.268	6.8					0.134	3.4		
S14K275			0.283	7.2					0.146	3.7		
S14K300			0.295	7.5					0.157	4.0		
S14K385			0.287	7.3					0.157	4.0		
S14K420			0.295	7.5					0.161	4.1		
S14K460			0.350	8.9					0.173	4.4		
S14K510			0.370	9.4					0.185	5.7		
S14K550			0.394	10.0					0.205	5.2		
S14K625			0.413	10.5					0.220	5.6		
S14K680	0.689	17.5	0.441	11.2	0.295	7.5	0.807	20.5	0.240	6.1		
S14K1000	0.709	18.0	0.618	15.7	0.394	10.0	0.866	22.0	0.374	9.5	0.031	0.8
S20K11	0.906	23.0	0.201	5.1	0.394	10.0	1.05	27.0	0.059	1.5	0.039	1.0
S20K14			0.205	5.2					0.063	1.6		
S20K17			0.209	5.3					0.067	1.7		
S20K20			0.217	5.5					0.075	1.9		
S20K25			0.217	5.5					0.075	1.9		
S20K30			0.220	5.6					0.075	1.9		
S20K35			0.224	5.7					0.083	2.1		
S20K40			0.228	5.8					0.094	2.4		
S20K50			0.217	5.5					0.071	1.8		
S20K60			0.220	5.6					0.079	2.0		
S20K75			0.224	5.7					0.087	2.2		
S20K95			0.232	5.9					0.094	2.4		
S20K130			0.236	6.0					0.094	2.4		
S20K140			0.244	6.2					0.102	2.6		
S20K150			0.248	6.3					0.106	2.7		
S20K175	0.906	23.0	0.256	6.5			1.06	27.0	0.114	2.9		
S20K230	0.945	24.0	0.283	7.2			1.10	28.0	0.138	3.5		
S20K250			0.291	7.4					0.145	3.7		
S20K275			0.303	7.7					0.157	4.0		
S20K300			0.315	8.0					0.169	4.3		
S20K385			0.311	7.9					0.169	4.3		
S20K420			0.335	8.5					0.173	4.4		
S20K460			0.354	9.0					0.189	4.8		
S20K510			0.374	9.5					0.201	5.1		
S20K550			0.394	10.0					0.236	6.0		
S20K625			0.413	10.5					0.236	6.0		
S20K680	0.945	24.0	0.441	11.2	0.394	10.0	1.10	28.0	0.256	6.5		
S20K1000	0.984	25.0	0.618	15.7	0.394	10.0	1.18	30.0	0.374	9.5	0.039	1.0

\*Tolerance  $\pm 1\text{mm}, 0.039\text{Inch}$



7-11-25  
A-11-09

**SIOV Marking**

As an example of varistor marking, the 5 disc types with Rated Voltage 300 V AC are shown below. The smaller parts (S05- and S07-series) have the letter "S" omitted due to space limitations.

Besides the part number, a 2-digit date code is also marked (e.g., "95" in the example). Alternatively, the date code may be a letter-number combination (e.g., T3) or a 2-letter combination (e.g. SN).

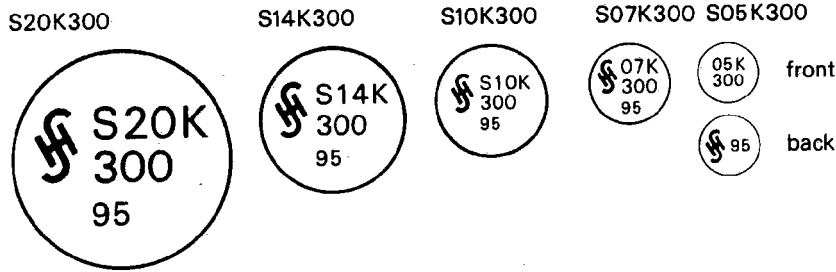

**Varistor Testing**

Test specifications have been developed by joint agreement between users and manufacturers. These are published in the document ANSI/IEEE C62.33, "IEEE Standard Test Specifications for Varistor Surge-Protective Devices."

- P<sub>1</sub> = adjustable DC power supply
- R<sub>1</sub> = 100k Ohm
- DVM = Digital Voltmeter
- VUT = Varistor under test

For incoming inspection, it is recommended that the Varistor Voltage (at 1mA DC) be measured. This can readily be done using the test circuit below. Initially, with the switch in the I position, adjust the power supply so the DVM reads 100V (this corresponds to a current of 1mA). Then place the switch in the V position, and the varistor voltage will be indicated on the DVM.

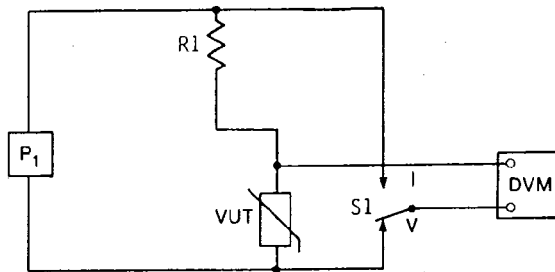

**Varistor Safety Recommendations**

Due to the inherently unpredictable nature of transients, it is possible that a varistor may be subjected to surges significantly in excess of its rated transient current and energy. This may result in failure by package rupture and expulsion of hot material. To prevent damage to other components or possible ignition of flammable materials, the varistor should be physically shielded from them.

Many types of SIOV-Varistors are UL Recognized. Contact Marketing for specific types.