

# S202SE1/S202SE2

# S216SE1/S216SE2

## ■ Features

- Comforms to European Safety Standard (EN60950)  
(Need of the insulation sheet when mounting external heat sink)  
Internal insulation distance : 0.4mm or more  
Creepage distance : 5mm or more  
Space distance : 4mm or more
- RMS ON-state current  
**S202SE1 / S202SE2** : 8Arms at  $T_c \leq 80^\circ\text{C}$   
(with heat sink)  
**S216SE1 / S216SE2** : 16Arms at  $T_c \leq 60^\circ\text{C}$   
(with heat sink)
- Isolation voltage between input and output ( $V_{iso}$  : 3 000V<sub>rms</sub>)
- Approved by TÜV, No. R9051479
- Recognized by UL, No. E94758  
**(S202SE1 / S202SE2)**  
Approved by CSA, No. LR63705  
**(S202SE1, S202SE2)**

## ■ Applications

- Copiers
- Laser beam printers

## ■ Line-up

	RMS ON-state current	
	MAX. 8Arms	MAX. 16Arms
No built-in Zero-cross circuit	<b>S202SE1</b>	<b>S216SE1</b>
Built-in Zero-cross circuit	<b>S202SE2</b>	<b>S216SE2</b>

## ■ Absolute Maximum Ratings

Parameter	Symbol	Rating		Unit
		S202SE1/S202SE2	S216SE1/S216SE2	
Input	Forward current	$I_F$	50	mA
	Reverse voltage	$V_R$	6	V
	RMS ON-state current	$I_T$	*48	A <sub>rms</sub>
	*1 Peak one cycle surge current	$I_{surge}$	80	A
Output	Repetitive peak OFF-state voltage	$V_{DRM}$	600	V
	Non-repetitive peak OFF-state voltage	$V_{DSM}$	600	V
	Critical rate of rise of ON-state current	$dI_T / dt$	50	A/ $\mu$ s
	Operating frequency	$f$	45 to 65	Hz
	*2 Isolation voltage	$V_{iso}$	3,000	V <sub>rms</sub>
	Operating temperature	$T_{opr}$	- 25 to + 100	$^\circ\text{C}$
	Storage temperature	$T_{stg}$	- 30 to + 125	$^\circ\text{C}$
	*3 Soldering temperature	$T_{sol}$	260	$^\circ\text{C}$

\*1 60Hz sine wave,  $T_j = 25^\circ\text{C}$  start

\*2 AC 60Hz for 1 minute, 40 to 60% RH, Apply voltages between input and output by the dielectric withstand voltage tester with zero-cross circuit.(Input and output shall be shorted respectively).

(Note) When the isolation voltage is necessary at using external heat sink, please use the insulation sheet.

\*3 For 10 seconds \*4  $T_c \leq 80^\circ\text{C}$  \*5  $T_c \leq 60^\circ\text{C}$

## SIP Type SSR for Medium Power Control

## ■ Outline Dimensions

(Unit : mm)

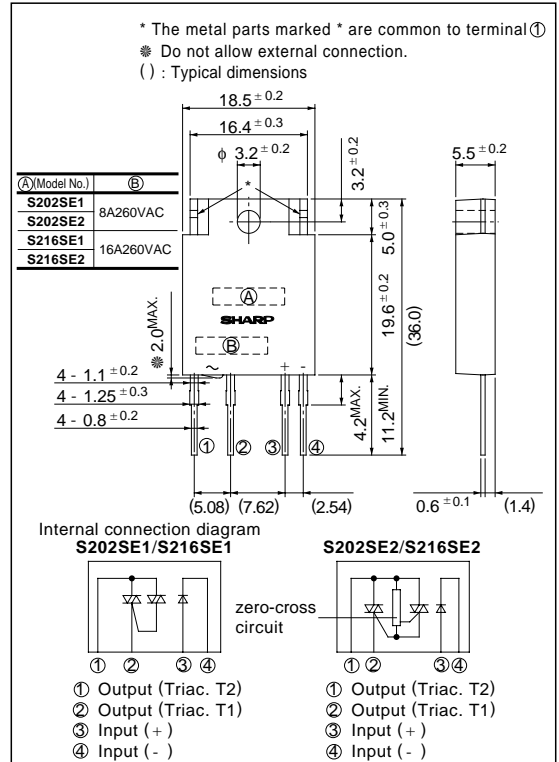

( $T_a = 25^\circ\text{C}$ )

## Electrical Characteristics

(Ta = 25°C)

Parameter		Symbol	Conditions	MIN.	TYP.	MAX.	Unit	
Input	Forward voltage	$V_F$	$I_F = 20\text{mA}$	-	1.2	1.4	V	
	Reverse current	$I_R$	$V_R = 3\text{V}$	-	-	$10^{-4}$	A	
Repetitive peak OFF-state current		$I_{DRM}$	$V_D = V_{DRM}$	-	-	$10^{-4}$	A	
Output	ON-state voltage	$V_T$	$I_T = 2A_{rms}$	-	-	1.5	$V_{rms}$	
			$I_T = 16A_{rms}$	-	-	1.5		
	Holding current		$I_H$	-	-	-	50	mA
	Critical rate of rise of OFF-state voltage		$dV/dt$	$V_D = 2/3V_{DRM}$	30	-	-	$V/\mu s$
	Critical rate of rise of commutating OFF-state voltage		$(dV/dt)_c$	$T_j = 125^\circ\text{C}, V_D = 400\text{V} *6$	5	-	-	$V/\mu s$
	Zero-cross voltage	<b>S202SE2/S216SE2</b>	$V_{OX}$	$I_F = 8\text{mA}$	-	-	35	V
Transfer characteristics	Minimum trigger current	$I_{FT}$	<b>S202SE1/S216SE1</b>	$V_D = 12\text{V}, R_L = 30\Omega$	-	-	8	mA
			<b>S202SE2/S216SE2</b>	$V_D = 6\text{V}, R_L = 30\Omega$	-	-	8	
			Isolation resistance		$R_{ISO}$	DC500V, 40 to 60 % RH	$10^{10}$	
	Turn-on time	$t_{on}$	<b>S202SE1/S216SE1</b>	AC60Hz	-	-	1	ms
			<b>S202SE2/S216SE2</b>	AC60Hz	-	-	9.3	
	Turn-off time		$t_{off}$	AC60Hz	-	-	9.3	ms
Thermal resistance (Between junction and case)		$R_{th(j-c)}$	-	-	-	4.5	-	$^\circ\text{C/W}$
					<b>S202SE1/S216SE1</b>	-	-	
Thermal resistance (Between junction and ambience)		$R_{th(j-a)}$	-	-	-	40	-	$^\circ\text{C/W}$

\*6  $dI_T/dt = -4.0\text{A/ms}$  (**S202SE1/S202SE2**) $dI_T/dt = -8.0\text{A/ms}$  (**S216SE1/S216SE2**)

Fig.1-a RMS ON-state Current vs. Ambient Temperature  
(S202SE1/ S202SE2)

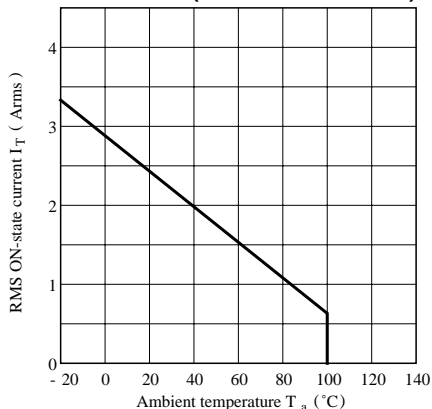
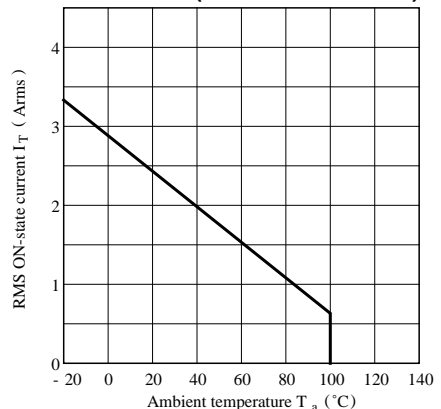
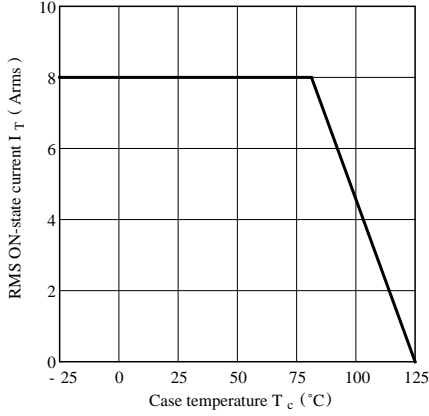

Fig.1-b RMS ON-state Current vs. Ambient Temperature  
(S216SE1/ S216SE2)



**Fig.2-a RMS ON-state Current vs. Case Temperature (S202SE1/ S202SE2)**



**Fig.2-b RMS ON-state Current vs. Case Temperature (S216SE1/ S216SE2)**

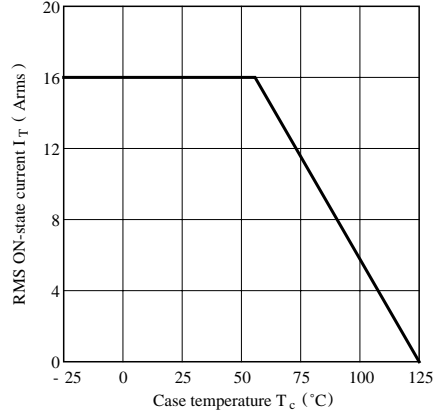

**Fig. 3 Forward Current vs. Ambient Temperature**

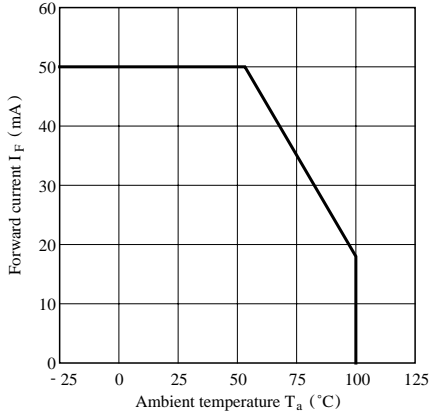

**Fig. 4 Forward Current vs. Forward Voltage**

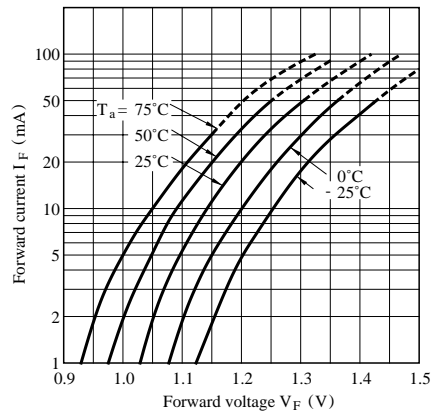

**Fig.5-a Surge Current vs. Power-ON Cycle (S202SE1/ S202SE2)**

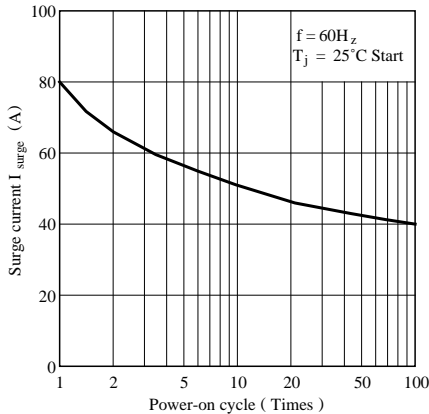

**Fig.5-b Surge Current vs. Power-ON Cycle (S216SE1/ S216SE2)**

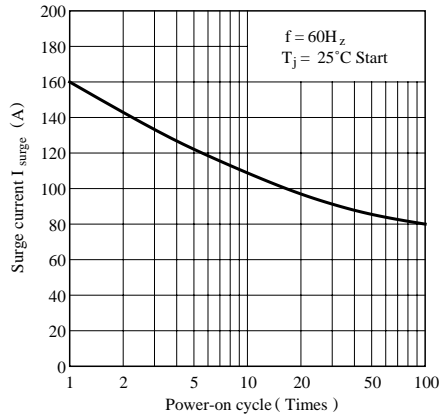

**Fig.6-a Maximum ON-State Power Dissipation vs. RMS ON-State Current (S202SE1 / S202SE2)**

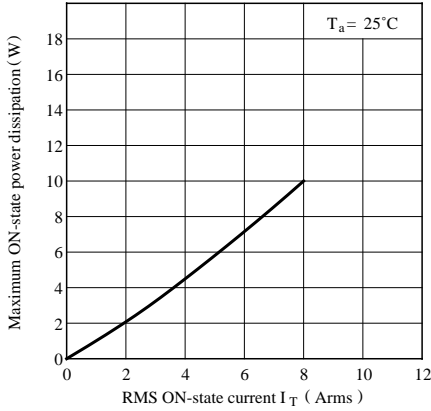

**Fig.6-b Maximum ON-State Power Dissipation vs. RMS ON-State Current (S216SE1 / S216SE2)**

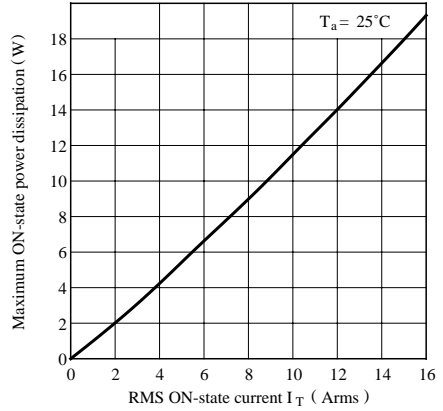

**Fig.7-a Minimum Trigger Current vs. Ambient Temperature (Typical Value) (S202SE1 / S216SE1)**

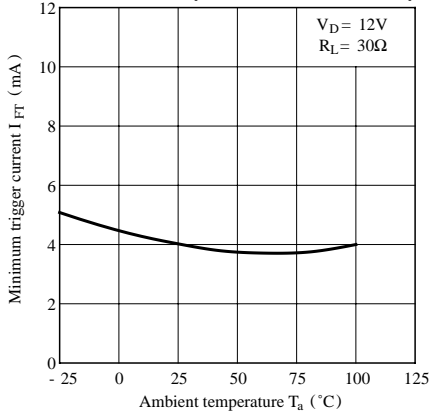

**Fig.7-b Minimum Trigger Current vs. Ambient Temperature (Typical Value) (S202SE2 / S216SE2)**

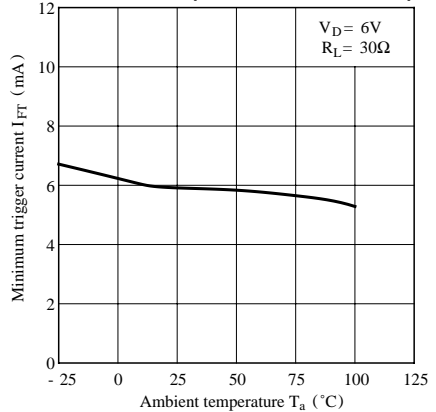

**Fig.8-a Repetitive Peak OFF-state Current vs. Ambient Temperature (Typical Value) (S202SE1 / S202SE2)**

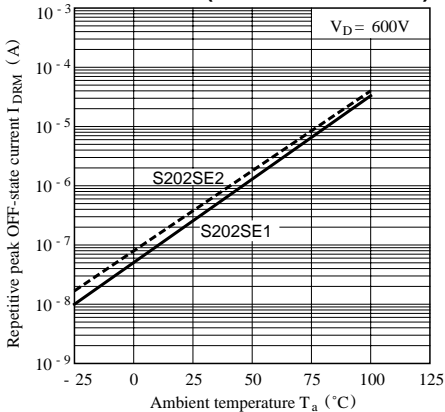

**Fig.8-b Repetitive Peak OFF-state Current vs. Ambient Temperature (Typical Value) (S216SE1 / S216SE2)**

