

1.5A Surface Mount Rectifier

Features

- Low profile surface mounted package
- Ideal for automated placement
- Glass passivated chip junction
- Low forward voltage drop
- Low leakage current
- High forward surge capability
- High temperature soldering: 250 °C / 10 seconds at terminals
- RoHS compliant



DO-214AA
(SMB)



Mechanical Data

Case:	JEDEC DO-214AA (SMB) molded plastic
Epoxy:	Plastic package has UL flammability classification 94V-0
Terminals:	Solder plated, solderable per MIL-STD-750, Method 2026
Polarity:	Color band denotes cathode end
Weight:	0.003 ounce, 0.093 gram

Maximum Ratings ($T_{Ambient}=25^{\circ}C$ unless noted)

Symbol	Description	S2A	S2B	S2D	S2G	S2J	S2K	S2M	Unit	Conditions
VRRM	Maximum Repetitive Peak Reverse Voltage	50	100	200	400	600	800	1000	V	
VRMS	Maximum RMS Voltage	35	70	140	280	420	560	700	V	
VDC	Maximum DC Blocking Voltage	50	100	200	400	600	800	1000	V	
IF(AV)	Maximum Average Forward Rectified Current	1.5							A	TL=100°C
IFSM	Peak Forward Surge Current	50							A	8.3ms single half sine-wave superimposed on rated load (JEDEC Method)
TJ, TSTG	Operating Junction and Storage Temperature Range	-55 to 150							°C	

1.5A Surface Mount Rectifier

S2A - S2M

Electrical Characteristics ($T_{Ambient}=25^{\circ}C$ unless noted)

Symbol	Description	S2A	S2B	S2D	S2G	S2J	S2K	S2M	Unit	Conditions
V_F	Maximum Instantaneous Forward Voltage	1.1							V	$I_F=1.5$ A
I_R	Maximum DC Reverse Current at Rated DC Blocking Voltage	1.0							μA	$T_A=25^{\circ}C$
		125								$T_A=125^{\circ}C$
T_{rr}	Typical Reverse Recovery Time	2.0							μS	$I_F=0.5A, I_R=1.0A, I_{rr}=0.25A$
C_J	Typical Junction Capacitance	30							pF	$V_R=4V, f=1MHz$
$R_{\theta-JA}$	Typical Thermal Resistance	53							$^{\circ}C/W$	Note 1
$R_{\theta-JL}$		16								

- Note:** (1) Thermal resistance from junction to ambient and from junction to lead mounted on P.C.B. with 0.3 x 0.3" (8.0 x 8.0mm) copper pad areas.
- (2) Single phase half wave, 60 Hz, resistive or inductive load.
For capacitive load, derate current by 20%.

Typical Characteristics Curves

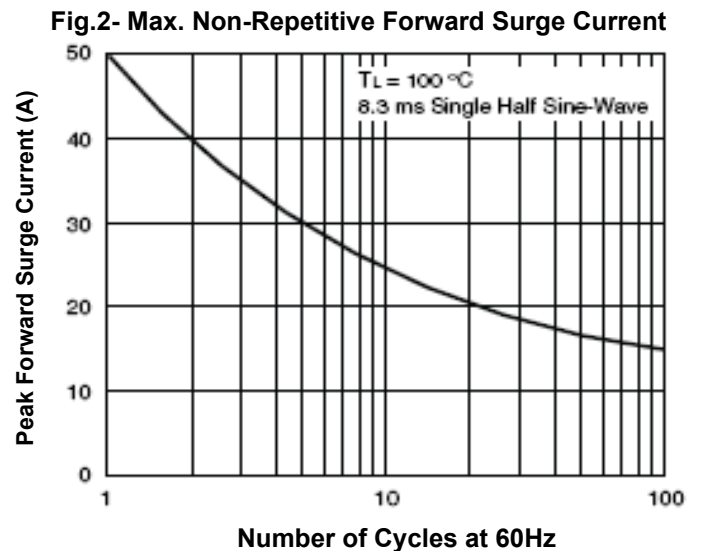
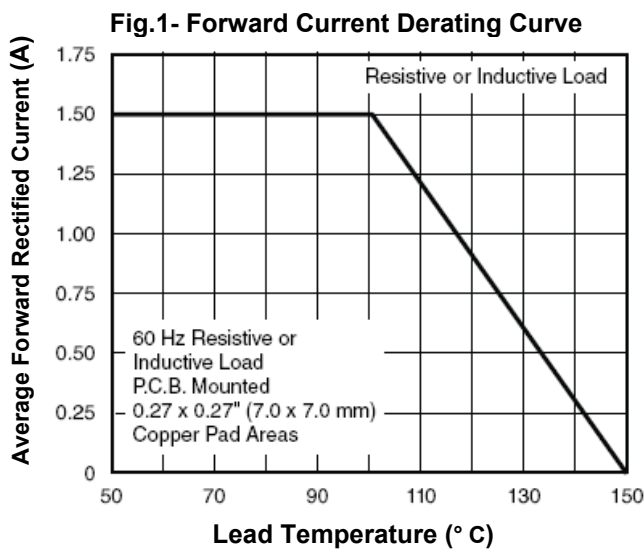

1.5A Surface Mount Rectifier

S2A - S2M

Fig.3- Typical Instantaneous Forward Characteristics

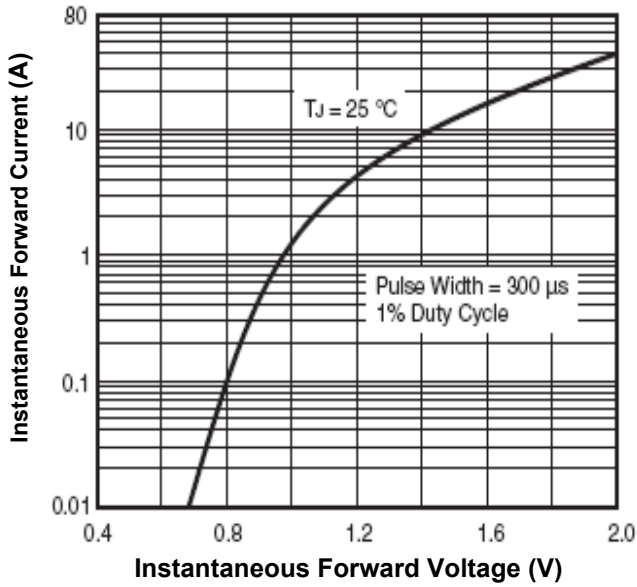

Fig.4- Typical Reverse Characteristics

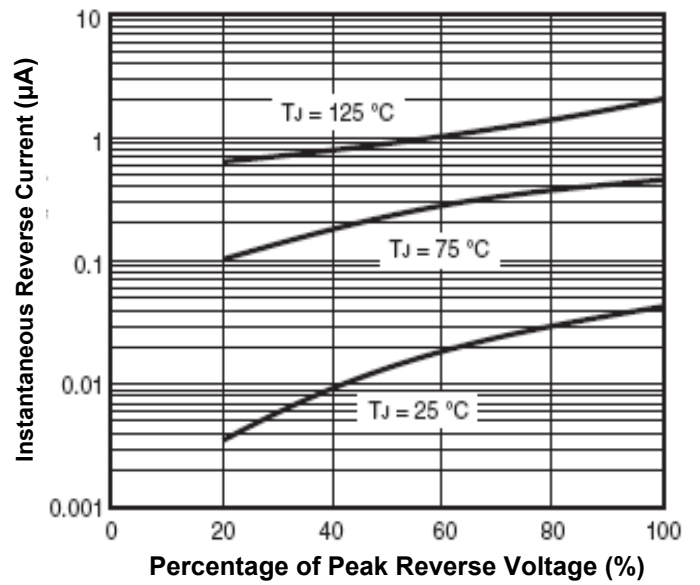
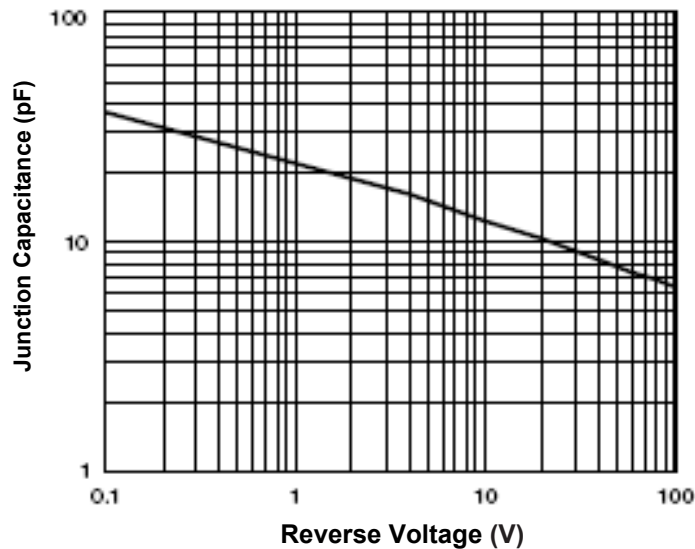

Fig.5- Junction Capacitance



1.5A Surface Mount Rectifier

S2A - S2M

Dimensions in inch (mm)

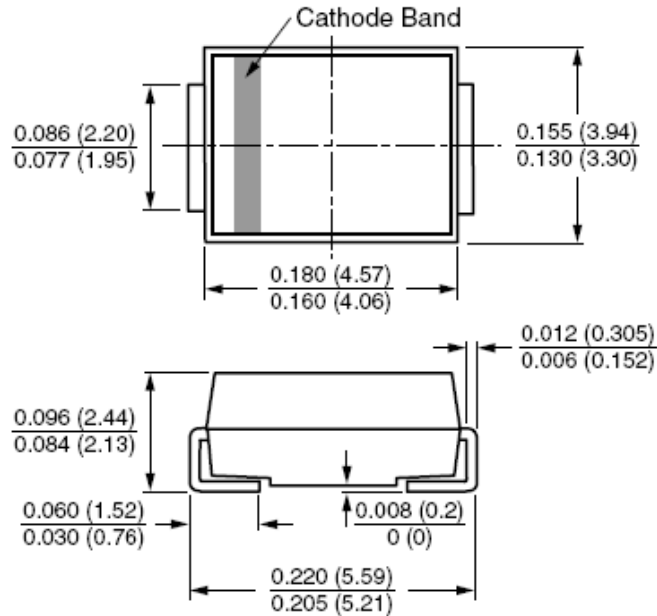

DO-214AA
(SMB)

Mounting Pad Layout in inch (mm)

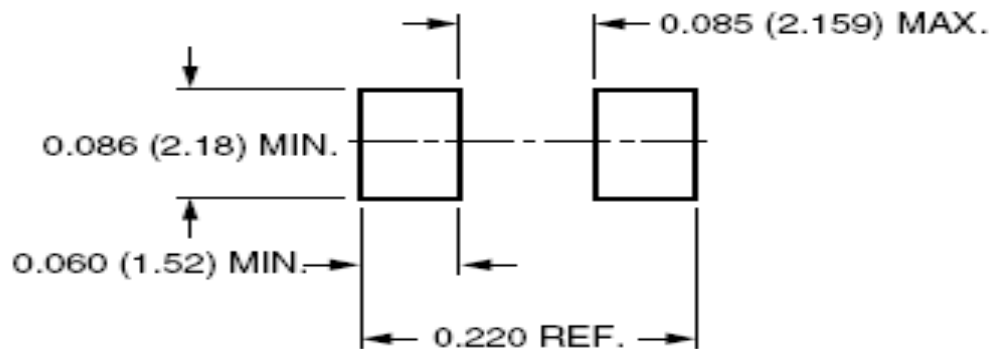

How to contact us

USA HEADQUARTERS

28040 WEST HARRISON PARKWAY, VALENCIA, CA 91355-4162

Tel: (800)-TAITRON (800)-824-8766 (661)-257-6060

Fax: (800)-TAITFAX (800)-824-8329 (661)-257-6415

Email: taitron@taitroncomponents.com

Http://www.taitroncomponents.com

TAITRON COMPONENTS INCORPORATED TAIWAN BRANCH

6F., NO.190, SEC. 2, ZHONGXING RD., XINDIAN DIST., NEW TAIPEI CITY 23146, TAIWAN R.O.C.

Tel: 886-2-2913-6238

Fax: 886-2-2913-6239

TAITRON COMPONENT TECHNOLOG SHANGHAI CORPORATION

SUITE 1503, METROBANK PLAZA, 1160 WEST YAN'AN ROAD, SHANGHAI, 200052, CHINA

Tel: +86-21-5424-9942

Fax: +86-21-2302-5027