

## 1.5A Surface Mount Rectifier

### Features

- Low profile surface mounted package
- Ideal for automated placement
- Glass passivated chip junction
- Low forward voltage drop
- Low leakage current
- High forward surge capability
- High temperature soldering: 250 °C / 10 seconds at terminals
- RoHS compliant



DO-214AA  
(SMB)



### Mechanical Data

<b>Case:</b>	JEDEC DO-214AA (SMB) molded plastic
<b>Epoxy:</b>	Plastic package has UL flammability classification 94V-0
<b>Terminals:</b>	Solder plated, solderable per MIL-STD-750, Method 2026
<b>Polarity:</b>	Color band denotes cathode end
<b>Weight:</b>	0.003 ounce, 0.093 gram

### Maximum Ratings ( $T_{Ambient}=25^{\circ}C$ unless noted)

Symbol	Description	S2A	S2B	S2D	S2G	S2J	S2K	S2M	Unit	Conditions
<b>VRRM</b>	Maximum Repetitive Peak Reverse Voltage	50	100	200	400	600	800	1000	V	
<b>VRMS</b>	Maximum RMS Voltage	35	70	140	280	420	560	700	V	
<b>VDC</b>	Maximum DC Blocking Voltage	50	100	200	400	600	800	1000	V	
<b>IF(AV)</b>	Maximum Average Forward Rectified Current	1.5							A	TL=100°C
<b>IFSM</b>	Peak Forward Surge Current	50							A	8.3ms single half sine-wave superimposed on rated load (JEDEC Method)
<b>TJ, TSTG</b>	Operating Junction and Storage Temperature Range	-55 to 150							°C	

# 1.5A Surface Mount Rectifier

## S2A - S2M

### Electrical Characteristics ( $T_{Ambient}=25^{\circ}C$ unless noted)

Symbol	Description	S2A	S2B	S2D	S2G	S2J	S2K	S2M	Unit	Conditions
$V_F$	Maximum Instantaneous Forward Voltage	1.1							V	$I_F=1.5 A$
$I_R$	Maximum DC Reverse Current at Rated DC Blocking Voltage	1.0							$\mu A$	$T_A=25^{\circ}C$
		125								$T_A=125^{\circ}C$
$T_{rr}$	Typical Reverse Recovery Time	2.0							$\mu S$	$I_F=0.5A, I_R=1.0A, I_{rr}=0.25A$
$C_J$	Typical Junction Capacitance	30							pF	$V_R=4V, f=1MHz$
$R_{\theta-JA}$	Typical Thermal Resistance	53							$^{\circ}C/W$	Note 1
$R_{\theta-JL}$		16								

- Note:** (1) Thermal resistance from junction to ambient and from junction to lead mounted on P.C.B. with 0.3 x 0.3" (8.0 x 8.0mm) copper pad areas.  
 (2) Single phase half wave, 60 Hz, resistive or inductive load.  
 For capacitive load, derate current by 20%.

### Typical Characteristics Curves

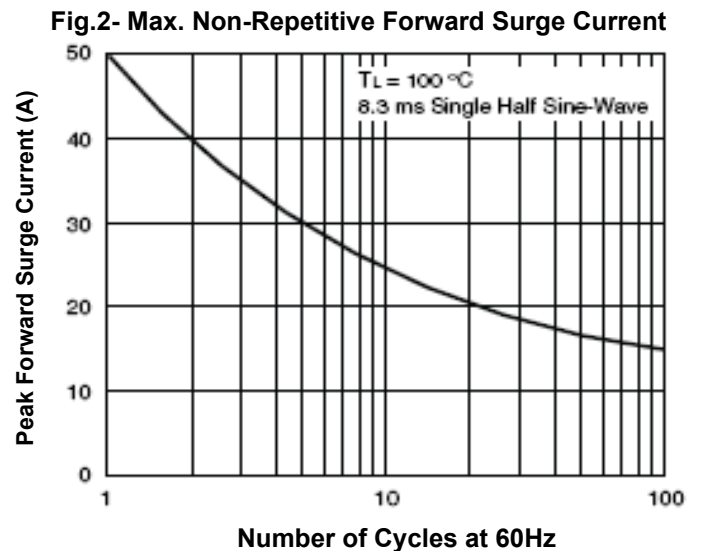
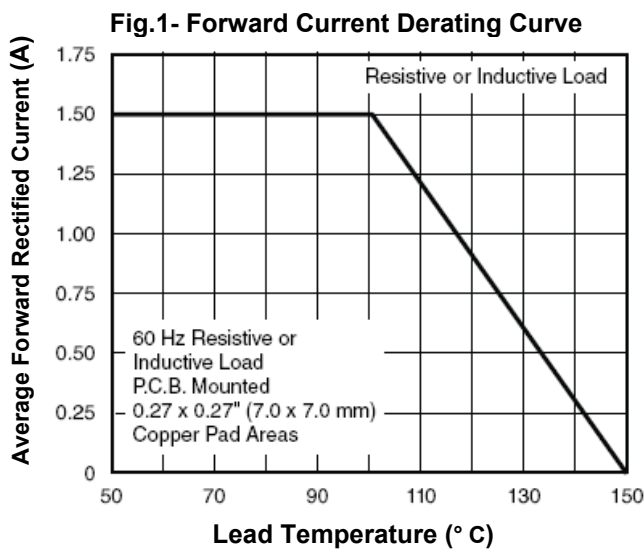

# 1.5A Surface Mount Rectifier

## S2A - S2M

Fig.3- Typical Instantaneous Forward Characteristics

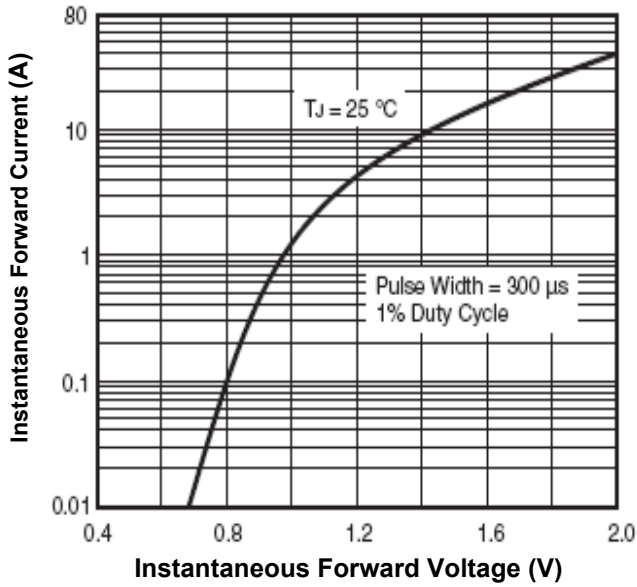

Fig.4- Typical Reverse Characteristics

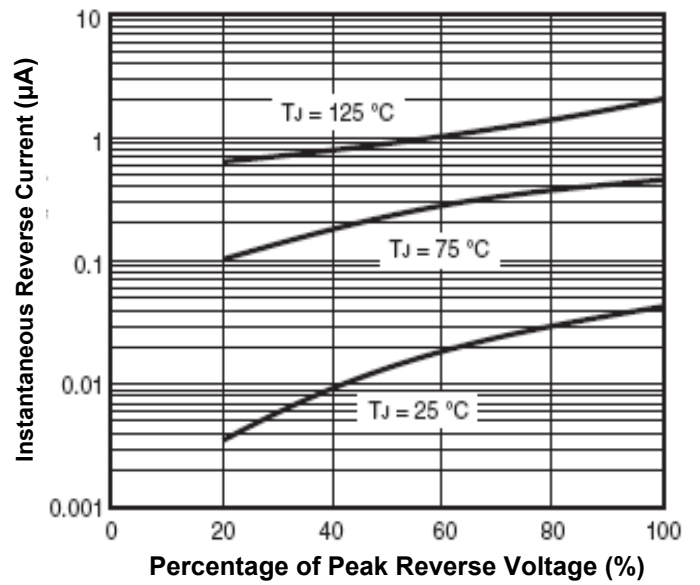
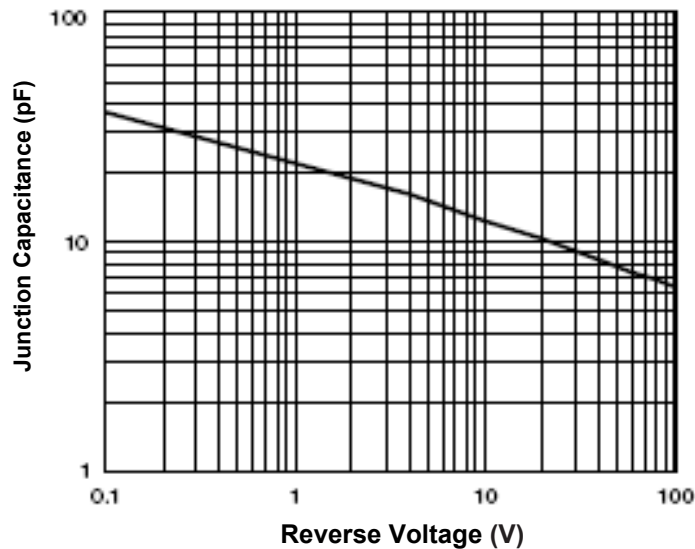

Fig.5- Junction Capacitance



# 1.5A Surface Mount Rectifier

S2A - S2M

## Dimensions in inch (mm)

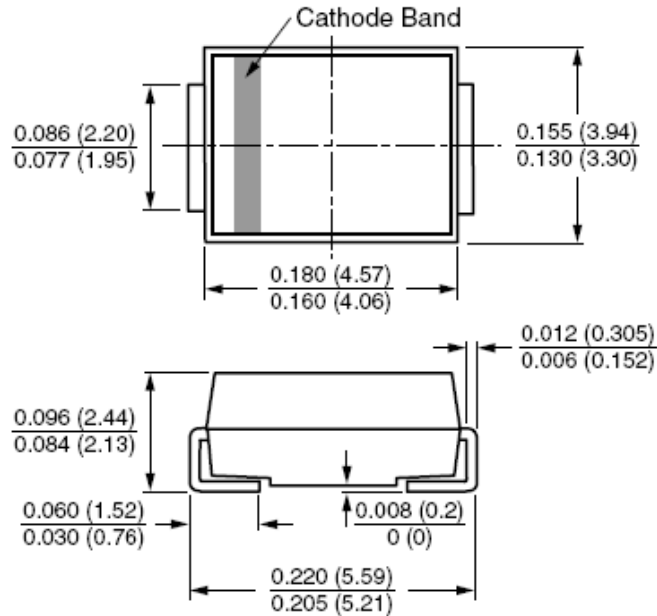

DO-214AA  
(SMB)

## Mounting Pad Layout in inch (mm)

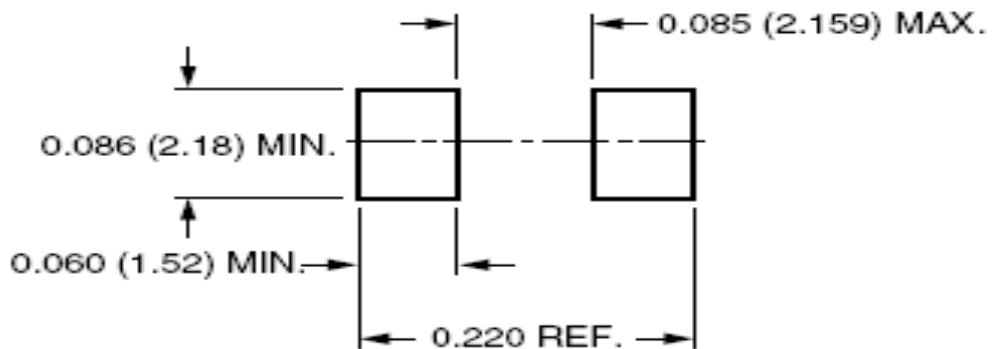

### How to contact us

**USA HEADQUARTERS**

28040 WEST HARRISON PARKWAY, VALENCIA, CA 91355-4162

Tel: (800)-TAITRON (800)-824-8766 (661)-257-6060

Fax: (800)-TAITFAX (800)-824-8329 (661)-257-6415

Email: [taitron@taitroncomponents.com](mailto:taitron@taitroncomponents.com)

Http://[www.taitroncomponents.com](http://www.taitroncomponents.com)

**TAITRON COMPONENTS INCORPORATED TAIWAN BRANCH**

6F., NO.190, SEC. 2, ZHONGXING RD., XINDIAN DIST., NEW TAIPEI CITY 23146, TAIWAN R.O.C.

Tel: 886-2-2913-6238

Fax: 886-2-2913-6239

**TAITRON COMPONENT TECHNOLOG SHANGHAI CORPORATION**

SUITE 1503, METROBANK PLAZA, 1160 WEST YAN'AN ROAD, SHANGHAI, 200052, CHINA

Tel: +86-21-5424-9942

Fax: +86-21-2302-5027