

Kingtronics®

S2AA THRU S2MA

FEATURE

- Plastic package has underwrites laboratory flammability Classification 94V-0
- For surface mounted applications
- Low profile package
- Built-in strain relief, ideal for automated placement
- Glass Passivated chip junction
- High temperature soldering guaranteed
- 250°C/10 second at terminals

VOLTAGE RANGE 50 to 1000 Volts CURRENT 2.0 Ampere

SURFACE MOUNT GLASS PASSIVATED RECTIFIER

SMA

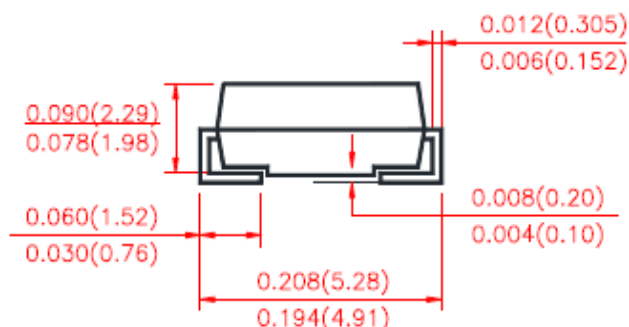
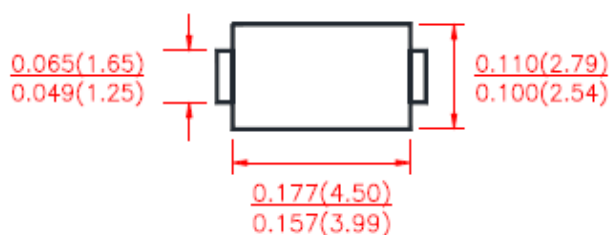

Dimensions in inches and (millimeters)

MECHANICAL DATA

- Case: JEDED SMA molded plastic over glass passivated chip
- Terminals: Solder plated, Solderable per MIL-STD-750, method 2026
- Polarity: Color band denotes cathode end
- SURFACE MOUNT GLASS PASSIVATED RECTIFIER

MAXIMUM RATINGS AND ELECTRICAL CHARACTERISTICS

Ratings at 25°C ambient temperature unless otherwise specified

MAXIMUM RATINGS & THERMAL CHARACTERISTICS

TYPE NUMBER	Symbol	S2AA	S2BA	S2DA	S2GA	S2JA	S2KA	S2MA	UNITS
Maximum Repetitive Peak Reverse Voltage	VRRM	50	100	200	400	600	800	1000	Volts
Maximum RMS Voltage	VRMS	35	70	140	280	420	560	700	Volts
Maximum DC Blocking Voltage	VDC	50	100	200	400	600	800	1000	Volts
Maximum Average Forward Rectified Current at T _L =100°C	I _{F(AV)}				2.0				Amps
Peak Forward Surge Current 8.3ms single half sine-wave superimposed on rated load (JEDEC method) T _L =100°C	IFSM				50				Amps
Typical Thermal Resistance (NOTE 1)	R _{θJA}				53				°C/W
	R _{θJL}				16				
Operating and Storage Temperature Range	T _J ,T _{STG}				-55 to +150				°C

Kingtronics® International Company

Kingtronics®

S2AA THRU S2MA

ELECTRICAL CHARACTERISTICS

	Symbol	S2AA	S2BA	S2DA	S2GA	S2JA	S2KA	S2MA	UNITS
Maximum Instantaneous Forward Voltage at 1.5A	V_F				1.10				Volts
Maximum DC Reverse Current at rated DC Blocking Voltage	I_R				5.0				μA
					200				
Typical Reverse Recovery Time at IF=0.5A, IR=1.0A, IRR=0.25A,	T_{rr}				2.5				μs
Typical junction capacitance at 4.0V, 1MHz	CJ				30				pF

Notes:

1. Thermal resistance from Junction to ambient and from junction to lead mounted on P.C.B. with 0.3×0.3"(8.0 × 8.0mm) copper pad areas.

RATINGS AND CHARACTERISTIC CURVES

F1G.1-FORWARD CURRENT DERATING CURVE

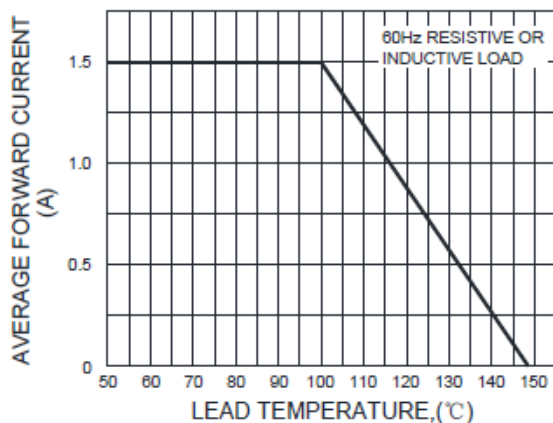

F1G.2-MAXIMUM NON-REPETITIVE PEAK FORWARD SURGE CURRENT

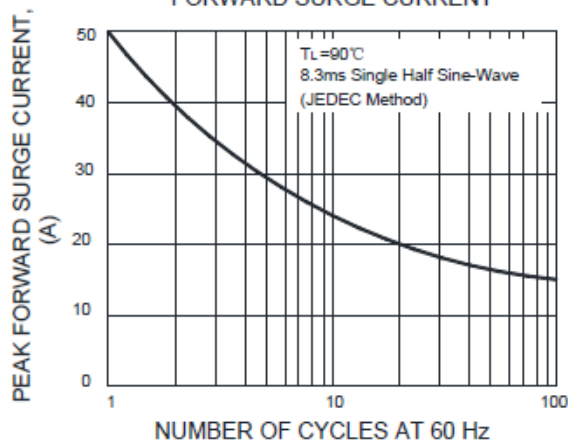

Kingtronics® International Company

Website: www.kingtronics.com

Email: info@kingtronics.com

Tel: (852) 8106 7033

Fax: (852) 8106 7099

Kingtronics®

S2AA THRU S2MA

FIG.3-TYPICAL INSTANTANEOUS FORWARD CHARACTERISTICS

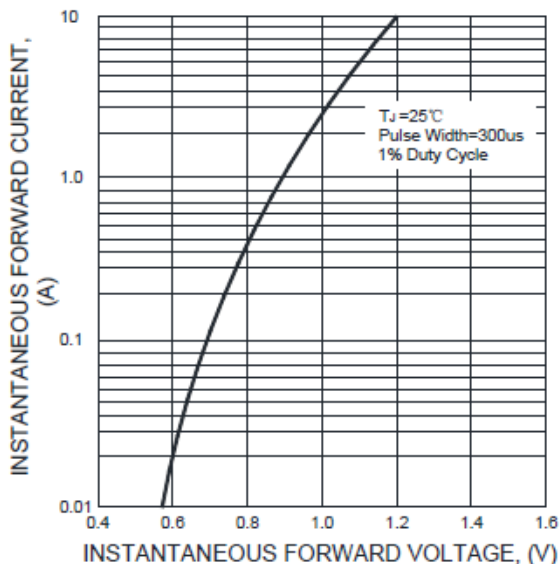

FIG.4-TYPICAL REVERSE CHARACTERISTICS

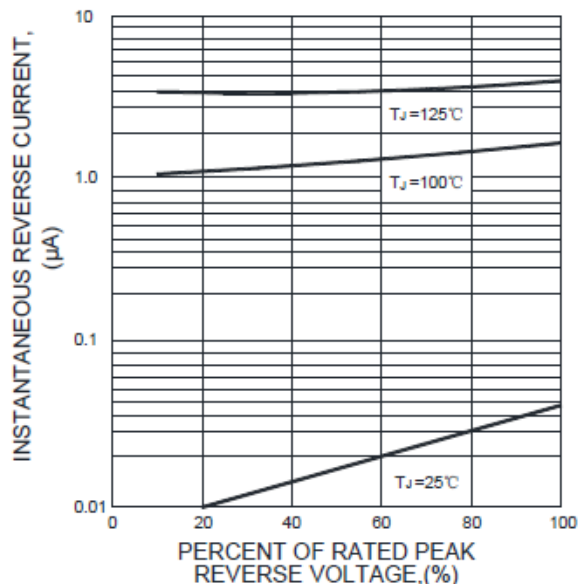
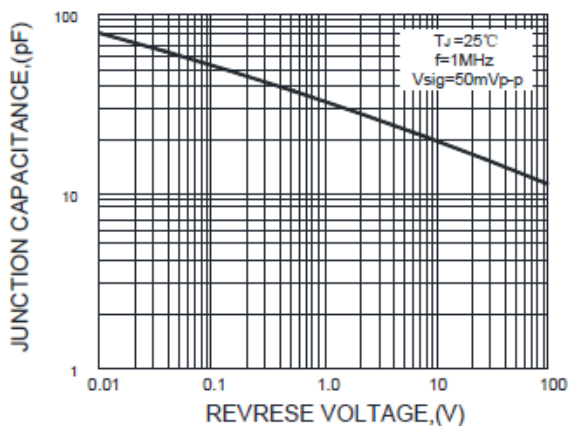

FIG.5-TYPICAL JUNCTION CAPACITANCE



Kingtronics® International Company