

SURFACE MOUNT GENERAL PURPOSE SILICON RECTIFIERS

FEATURES:

- For surface mounted applications
- Low profile package
- Glass Passivated Chip Junction
- Easy to pick and place
- Lead free in comply with EU RoHS 2011/65/EU directives

MECHANICAL DATA

- Case: SMBF
- Terminals: Solderable per MIL-STD-750, Method 2026
- Approx. Weight: 57mg / 0.002oz

PINNING

| PIN | DESCRIPTION |
|-----|-------------|
| 1 | Cathode |
| 2 | Anode |

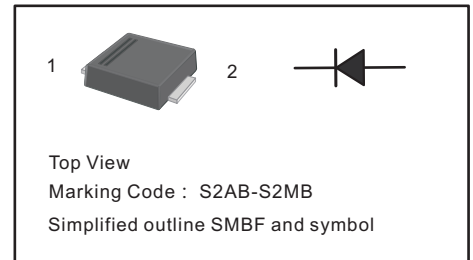

Maximum Ratings and Electrical characteristics

- Ratings at 25 °C ambient temperature unless otherwise specified.
- Single phase half-wave 60 Hz, resistive or inductive load, for capacitive load current derate by 20 %.

| Parameter | Symbols | S2ABF | S2BBF | S2DBF | S2GBF | S2JBF | S2KBF | S2MBF | Units |
|--|------------------------------------|------------|-------|-------|-------|-------|-------|-------|--------------------|
| Maximum Repetitive Peak Reverse Voltage | V_{RRM} | 50 | 100 | 200 | 400 | 600 | 800 | 1000 | V |
| Maximum RMS voltage | V_{RMS} | 35 | 70 | 140 | 280 | 420 | 560 | 700 | V |
| Maximum DC Blocking Voltage | V_{DC} | 50 | 100 | 200 | 400 | 600 | 800 | 1000 | V |
| Maximum Average Forward Rectified Current at $T_c = 125\text{ }^\circ\text{C}$ | $I_{F(AV)}$ | 2 | | | | | | | A |
| Peak Forward Surge Current 8.3 ms Single Half Sine Wave Superimposed on Rated Load | I_{FSM} | 50 | | | | | | | A |
| Maximum Instantaneous Forward Voltage at 2 A | V_F | 1.1 | | | | | | | V |
| Maximum DC Reverse Current at Rated DC Blocking Voltage | I_R | 5 100 | | | | | | | μA |
| Typical Junction Capacitance ⁽¹⁾ | C_j | 25 | | | | | | | pF |
| Typical Thermal Resistance ⁽²⁾ | $R_{\theta JA}$ $R_{\theta JC}$ | 60 18 | | | | | | | $^\circ\text{C/W}$ |
| Operating and Storage Temperature Range | T_j, T_{stg} | -55 ~ +150 | | | | | | | $^\circ\text{C}$ |

Notes:

- (1) Measured at 1 MHz and applied reverse voltage of 4 V D.C
(2) P.C.B. mounted with 2.0" X 2.0" (5 X 5 cm) copper pad areas.

SURFACE MOUNT GENERAL PURPOSE SILICON RECTIFIERS

RATINGS AND CHARACTERISTIC CURVES S2ABF - S2MBF

Fig.1 Forward Current Derating Curve

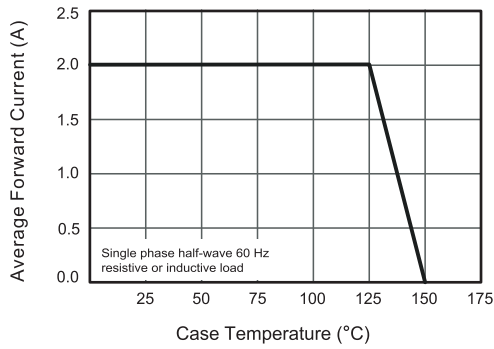

Fig.2 Typical Reverse Characteristics

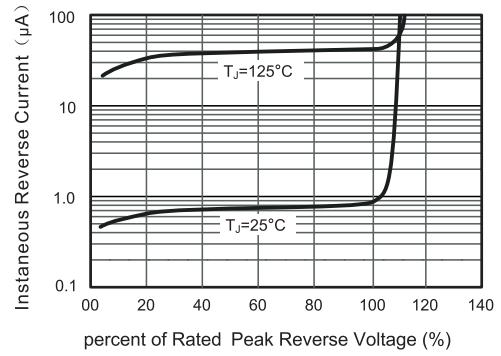

Fig.3 Typical Forward Characteristic

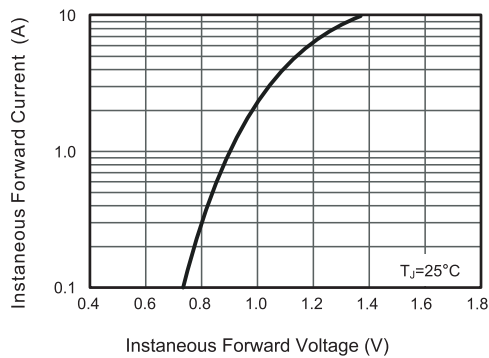

Fig.4 Typical Junction Capacitance

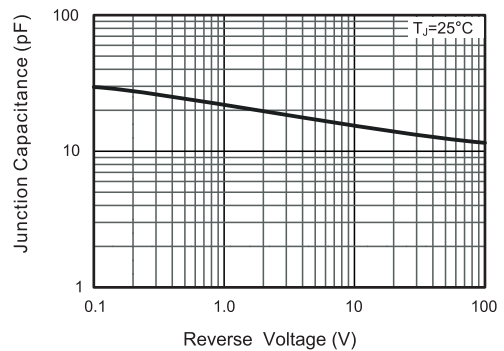
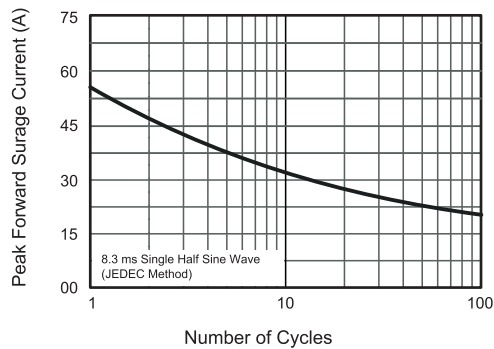

Fig.5 Maximum Non-Repetitive Peak Forward Surge Current



SURFACE MOUNT GENERAL PURPOSE SILICON RECTIFIERS

PACKAGE OUTLINE

Plastic surface mounted package; 2 leads

SMBF

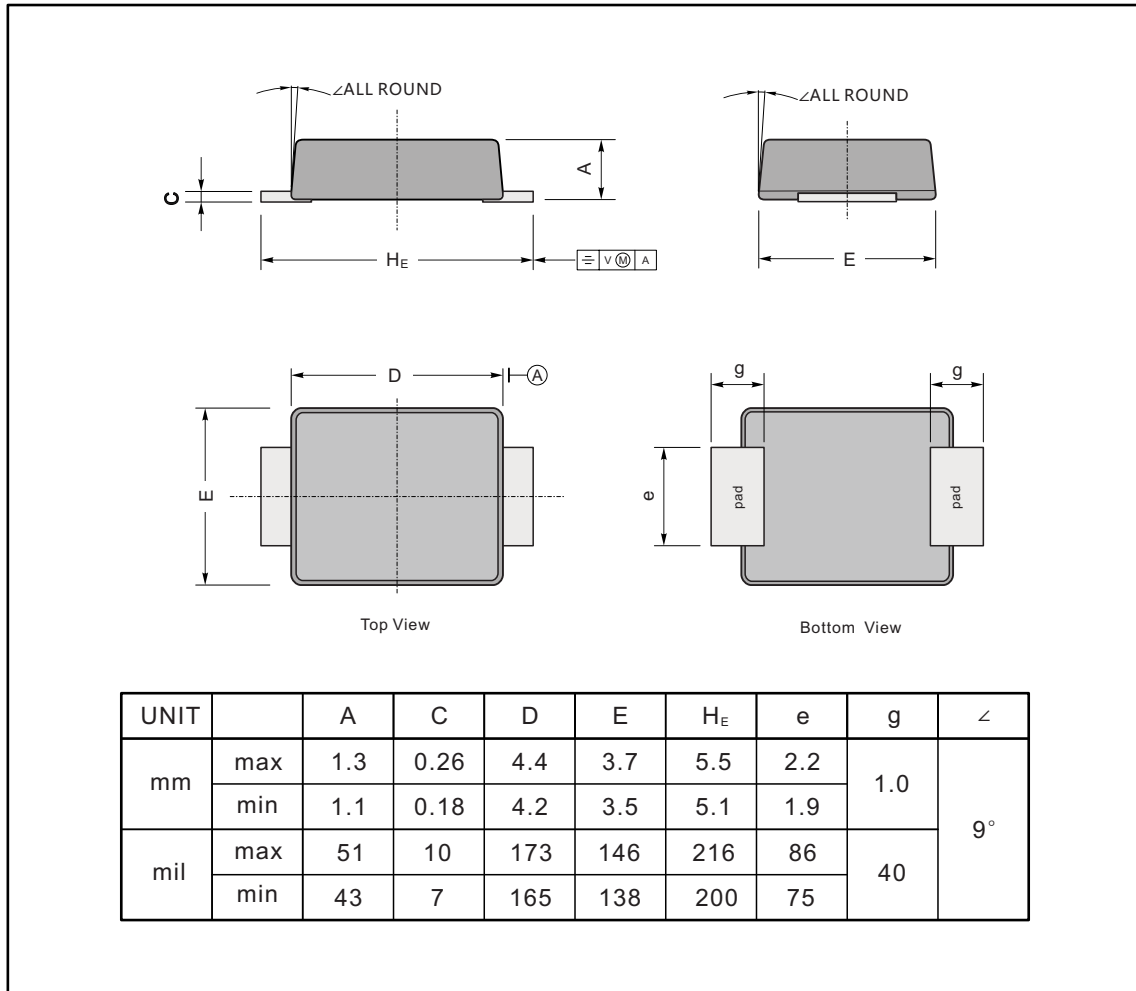

The recommended mounting pad size

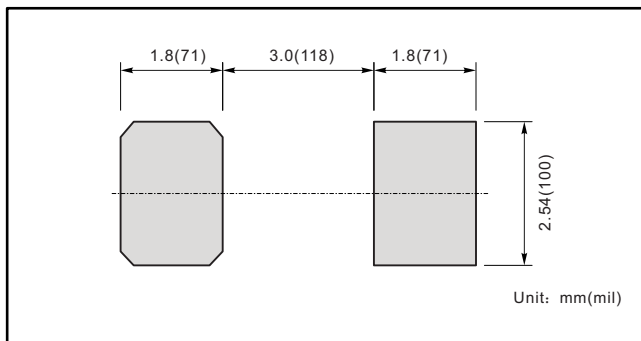

Marking

| Type number | Marking code |
|-------------|--------------|
| S2ABF | S2AB |
| S2BBF | S2BB |
| S2DBF | S2DB |
| S2GBF | S2GB |
| S2JBF | S2JB |
| S2KBF | S2KB |
| S2MBF | S2MB |

Disclaimer

All product, product specifications and data are subject to change without notice to improve reliability, function or design or otherwise.