

Service  
Service  
**Service**

# SDI PDP Repair Manual

S37SD-YD02 (37-inch SD v4)

S42SD-YD05, YD06, YD07 (42-inch SD v2, v3, v4)

S42AX-XD02, YD01 (42-inch HD v3, v4)

S50HW-XD03, XD04 (50-inch HD v3, v4)

# Service Manual

Contents	Page
1. Technical Specifications, Connections, and Chassis Overview	2
2. Safety Instructions, Warnings, and Notes	15
3. Directions For Use	16
4. Mechanical Instructions	17
5. Service Modes, Error Codes, and Fault Finding	25
6. Block Diagrams, Test Point Overview, and Waveforms	40
7. Circuit Diagrams and PWB Layouts	51
8. Alignments	52
9. Circuit Descriptions, Abbreviation List, and IC Data Sheets	71
10. Spare Parts List	72
11. Revision List	77

©Copyright 2006 Philips Consumer Electronics B.V. Eindhoven, The Netherlands.  
All rights reserved. No part of this publication may be reproduced, stored in a retrieval system or transmitted, in any form or by any means, electronic, mechanical, photocopying, or otherwise without the prior permission of Philips.



# 1. Technical Specifications, Connections, and Chassis Overview

**Index of this chapter:**

- 1.1 PDP Overview
- 1.2 Serial Numbers
- 1.3 Chassis Overview

**Notes:**

- Figures can deviate due to the different model executions.
- Specifications are indicative (subject to change).

## 1.1 PDP Overview

**Table 1-1 PDP overview**

	PDP Type/Version	Model Name	H x V Pixel
1	37" SD v4	S37SD-YD02	852 x 480
2	42" SD v2	S42SD-YD06	852 x 480
3	42" SD v3	S42SD-YD05	852 x 480
4	42" SD v4	S42SD-YD07	852 x 480
5	42" HD v3	S42AX-XD02	1024 x 768
6	42" HD v4	S42AX-YD01	1024 x 768
7	50" HD v3	S50HW-XD03	1366 x 768
8	50" HD v4	S50HW-XD04	1366 x 768

**Table 1-2 PDP vs Chassis overview**

Display type	Model #	Chassis	Chassis Manual #
37" SD v4	37PF9936/37	LC4.7U	3122 785 14742
37" SD v4	37PF9946/12	LC4.7E	3122 785 14722
37" SD v4	37PF9946/69	LC4.7A	3122 785 14761
42" SD v2	420P20/00	FM242	3122 785 14130
42" SD v2	42FD9925/01	FM242	3122 785 14130
42" SD v2	42FD9935/17	FM242	3122 785 14130
42" SD v2	42FD9935/93S	FM242	3122 785 14130
42" SD v2	42FD9945/01	FM242	3122 785 14130
42" SD v2	42FD9953/17, /69, /93	FM242	3122 785 14130
42" SD v2	42HF9953/12Z	FM24_AB	3122 785 13890
42" SD v2	42PF9936/37	FTP1.1U	3122 785 14381
42" SD v2	42PF9945/12	FTP1.1E	3122 785 14370
42" SD v2	42PF9945/69, /79, /98	FTP1.1U	3122 785 14381
42" SD v2	42PF9955/12	F21RE	3122 785 13890
42" SD v3	42PF9936D/37	LC4.7U	3122 785 14742
42" SD v3	42PF9946/12	LC4.7E	3122 785 14722
42" SD v3	42PF9946/79, /93, /98	LC4.7A	3122 785 14761
42" SD v3	42PF9956/12	FTP2.2E	3122 785 14651
42" SD v3	42PF9956/93	FTP2.2A	3122 785 14680
42" SD v4	42PF7320/10	LC4.9E	3122 785 15431
42" SD v4	42PF7320/79, /98	LC4.9A	3122 785 15450
42" HD v3	42PF9966/37	FTP2.2U	3122 785 14662
42" HD v3	42PF9966/79, /93, /98	FTP2.2A	3122 785 14680
42" HD v3	42PF9976/37	FTP2.2U	3122 785 14662
42" HD v4	42HF7543/37	BP2.3HU	3122 785 15900
42" HD v4	42PF7320A/37	BP2.3U	3122 785 15541
42" HD v4	42PF7520D/10	LC4.9E_AB	3122 785 15670
42" HD v4	42PF9630/78	FTP2.4L	3122 785 15470
42" HD v4	42PF9630A/37	BP2.2U	3122 785 15541
42" HD v4	42PF9630A/96	BP2.2U	3122 785 15541
42" HD v4	42PF9966/79, /98	FTP2.4A	3122 785 15470
50" HD v3	50PF9956/37	FTP2.2U	3122 785 14662
50" HD v3	50PF9966/12	FTP2.2E	3122 785 14651
50" HD v3	50PF9966/37	FTP2.2U	3122 785 14662
50" HD v3	50PF9966/69, /93	FTP2.2A	3122 785 14680
50" HD v4	50HF7543/37	BP2.3HU	3122 785 15900
50" HD v4	50PF7320/10	LC4.9E	3122 785 15431
50" HD v4	50PF7320/79, /93, /98	LC4.9A	3122 785 15450
50" HD v4	50PF9630/78	LC4.9L	3122 785 15450
50" HD v4	50PF9630A/96	BP2.2U	3122 785 15541
50" HD v4	50PF9830A/37	BP2.1U	3122 785 15541
50" HD v4	50PF9966/79	FTP2.4A	3122 785 15470
50" HD v4	50PF9967D/10	FTP2.4E_AB	3122 785 15740

In above table the link is given between the SDI Plasma Display Panel and the Philips TV chassis (incl. chassis manual no.).

### 1.1.1 37" SD v4

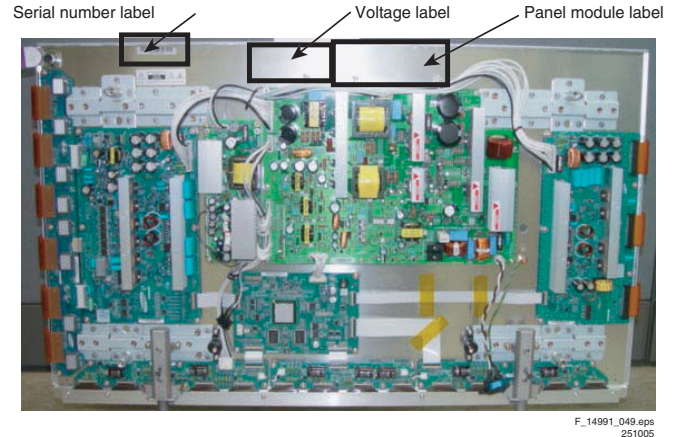

**Figure 1-1 External view (37" SD v4)**

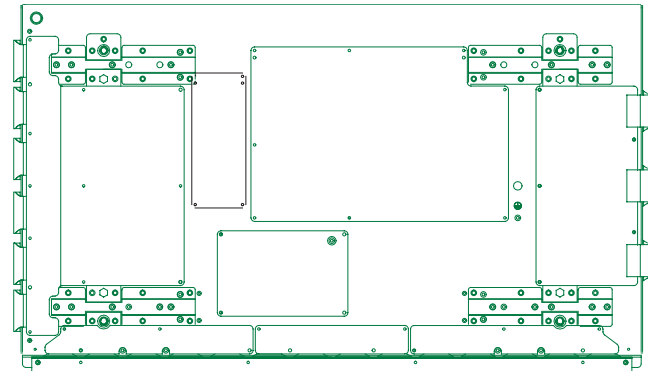

**Figure 1-2 Points of screw mount (37" SD v4)**

No	Item	Specification 37" SD v4
1	Pixel	852 (H) x 480 (V) pixels (1 pixel = 1 R,G,B cells)
2	Number of Cells	2556 (H) x 480 (V)
3	Pixel Pitch	0.960 mm (H) x 0.960 mm (V)
4	Cell Pitch	R 0.320 (H) mm 0.960 (V) mm
		G 0.320 (H) mm 0.960 (V) mm
		B 0.320 (H) mm 0.960 (V) mm
5	Display size	817.92 (H) x 460.80 mm (V)
6	Screen size	Diagonal 37" Colour Plasma Display Module
7	Screen aspect	16:9
8	Display colour	16.77 million colours
9	Viewing angle	Over 160 deg (angle with 50% and greater brightness perpendicular to PDP module)
10	Dimensions	982 (W) x 582 (H) x 52.9 (D) mm
11	Weight	Module 1 About 15.5 kg
12	Broadc. reception Vertical frequency Video/Logic Interface	60/50 Hz, LVDS

1.1.2 42" SD v2

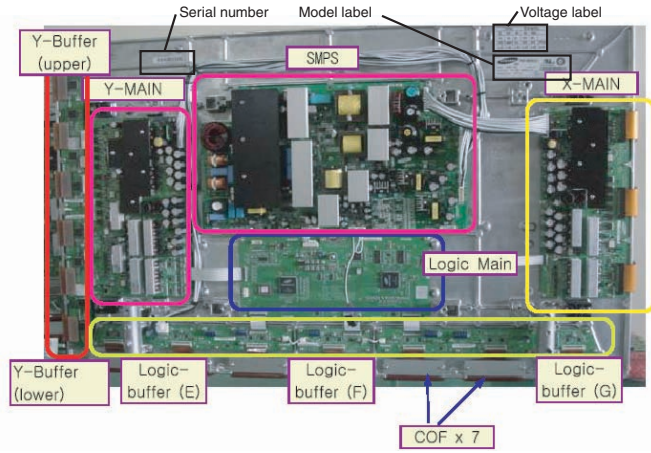
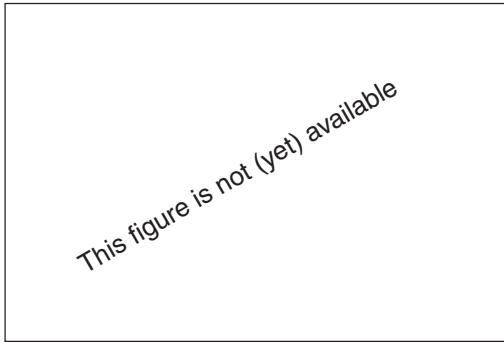

Figure 1-3 External view (42" SD v2)



F\_14991\_035.eps  
061005

Figure 1-4 Points of screw mount (42" SD v2)

No	Item	Specification 42" SD v2
1	Pixel	852 (H) x 480 (V) pixels (1 pixel = 1 R,G,B cells)
2	Number of Cells	2556 (H) x 480 (V)
3	Pixel Pitch	1.095 mm (H) x 1.110 mm (V)
4	Cell Pitch	R 0.324 (H) mm 1.110 (V) mm
		G 0.365 (H) mm 1.110 (V) mm
		B 0.406 (H) mm 1.110 (V) mm
5	Display size	932.940 (H) x 532.800(V) mm
6	Screen size	Diagonal 42" Colour Plasma Display Module
7	Screen aspect	16:9
8	Display colour	16.77 million colours
9	Viewing angle	Over 160 deg (angle with 50% and greater brightness perpendicular to PDP module)
10	Dimensions	982 (W) x 582 (H) x 52.9 (D) mm
11	Weight	Module 1   About 16.6 kg
12	Broadc. reception Vertical frequency Video/Logic Interface	60/50 Hz, LVDS

1.1.3 42" SD v3

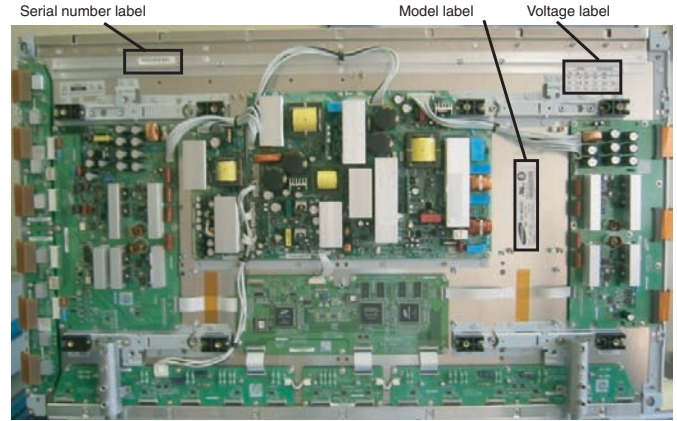

Figure 1-5 External view (42" SD v3)

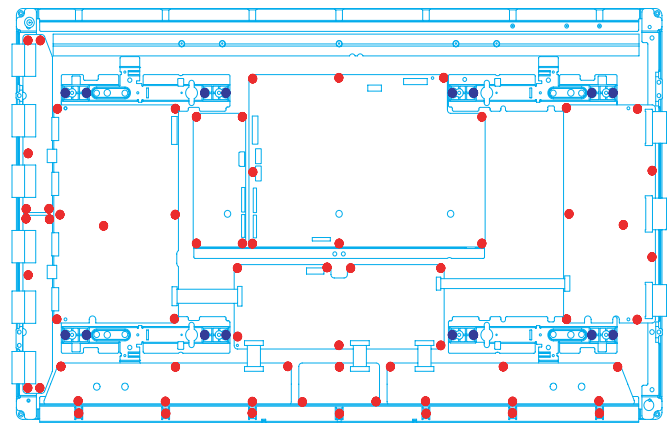

Figure 1-6 Points of screw mount (42" SD v3)

No	Item	Specification 42" SD v3
1	Pixel	852 (H) x 480 (V) pixels (1 pixel = 1 R,G,B cells)
2	Number of Cells	2556 (H) x 480 (V)
3	Pixel Pitch	1.095 mm (H) x 1.110 mm (V)
4	Cell Pitch	R 0.365 (H) mm 1.110 (V) mm
		G 0.365 (H) mm 1.110 (V) mm
		B 0.365 (H) mm 1.110 (V) mm
5	Display size	932.940 (H) x 532.800(V) mm
6	Screen size	Diagonal 42" Colour Plasma Display Module
7	Screen aspect	16:9
8	Display colour	16.77 million colours
9	Viewing angle	Over 160 deg (angle with 50% and greater brightness perpendicular to PDP module)
10	Dimensions	982 (W) x 582 (H) x 52.9 (D) mm
11	Weight	Module 1   About 16.6 kg
12	Broadc. reception Vertical frequency Video/Logic Interface	60/50 Hz, LVDS

1.1.4 42" SD v4

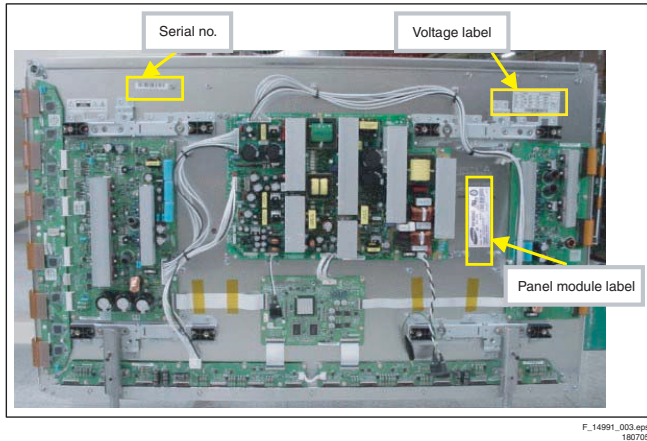

Figure 1-7 External view (42" SD v4)

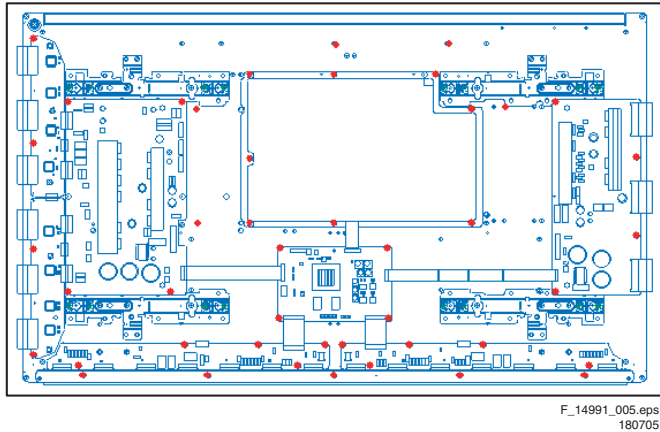

Figure 1-8 Points of screw mount (42" SD v4)

No	Item	Specification 42" SD v4	
1	Pixel	852 (H) x 480 (V) pixels (1 pixel = 1 R,G,B cells)	
2	Number of Cells	2556 (H) x 480 (V)	
3	Pixel Pitch	1.095 (H) mm x 1.110 (V) mm	
4	Cell Pitch	R	0.365 (H) mm x 1.110 (V) mm
		G	0.365 (H) mm x 1.110 (V) mm
		B	0.365 (H) mm x 1.110 (V) mm
5	Display size	932.940 (H) x 532.800(V) mm	
6	Screen size	Diagonal 42" Colour Plasma Display Module	
7	Screen aspect	16:9	
8	Display colour	16.77 million colours	
9	Viewing angle	Over 160 deg (angle with 50% and greater brightness perpendicular to PDP module)	
10	Dimensions	982 (W) x 582 (H) x 54 (D) mm	
11	Weight	Module 1	About 15.4 kg
14	Broadc. reception Vertical frequency Video/Logic Interface	60 Hz/ 50 Hz, LVDS	

1.1.5 42" HD v3

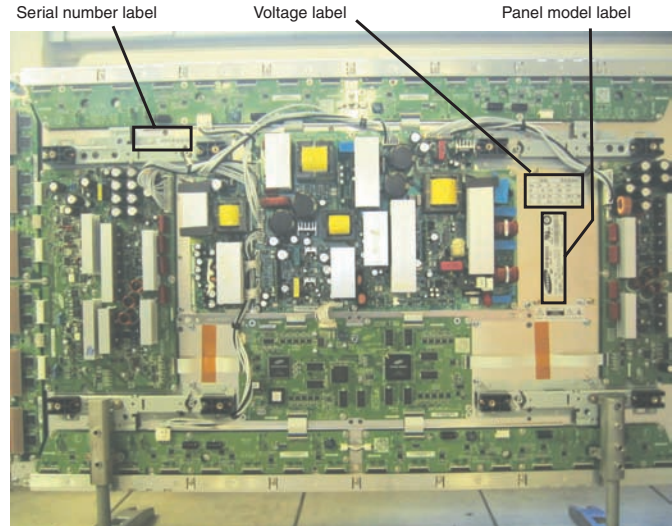

Figure 1-9 External view (42" HD v3)

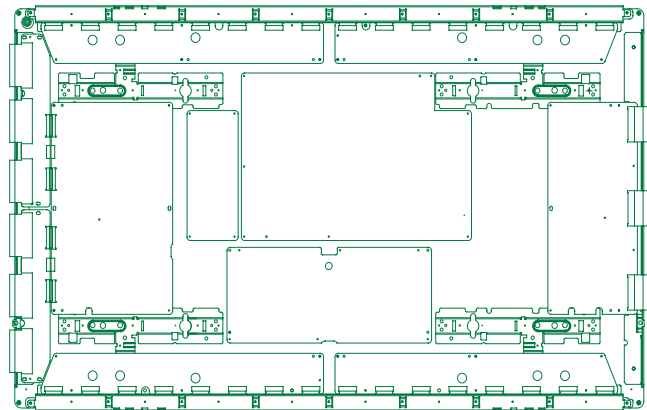

Figure 1-10 Points of screw mount (42" HD v3)

No	Item	Specification 42" HD v3	
1	Pixel	1.024 (H) x 768 (V) pixels (1 pixel = 1 R,G,B cells)	
2	Number of Cells	3072 (H) x 768 (V)	
3	Pixel Pitch	0.912mm (H) x 0.693mm (V)	
4	Cell Pitch	R	Horizontal 0.304 mm Vertical 0.693 mm
		G	Horizontal 0.304 mm Vertical 0.693 mm
		B	Horizontal 0.304 mm Vertical 0.693 mm
5	Display size	932.940 (H) x 532.800(V) mm	
6	Screen size	Diagonal 42" Colour Plasma Display Module	
7	Screen aspect	16:9	
8	Display colour	16.77 million colours	
9	Viewing angle	Over 160 deg (angle with 50% and greater brightness perpendicular to PDP module)	
10	Dimensions	982 (W) x 582 (H) x 52.9 (D) mm	
11	Weight	Module 1	About 18.0 kg
12	Broadc. reception Vertical frequency Video/Logic Interface	60/50 Hz, LVDS	

1.1.6 42" HD v4

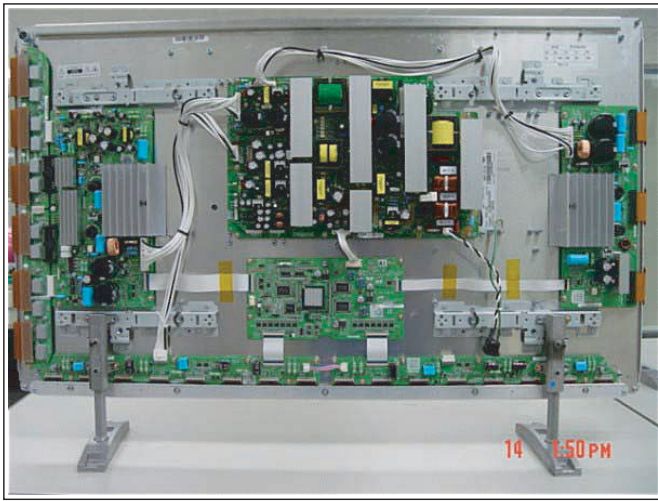

Figure 1-11 External view (42" HD v4)

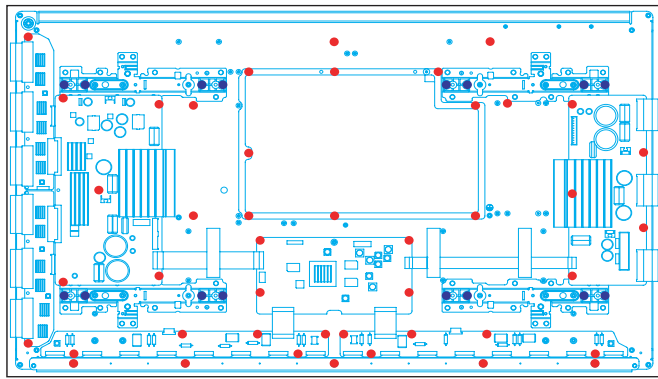

Figure 1-12 Points of screw mount (42" HD v4)

No	Item	Specification 42" HD v4	
1	Pixel	1.024 (H) x 768 (V) pixels (1 pixel = 1 R,G,B cells)	
2	Number of Cells	3072 (H) x 768 (V)	
3	Pixel Pitch	0.912mm (H) x 1.110mm (V)	
4	Cell Pitch	R	Horizontal 0.304 mm Vertical 0.693 mm
		G	Horizontal 0.304 mm Vertical 0.693 mm
		B	Horizontal 0.304 mm Vertical 0.693 mm
5	Display size	933.98 (H) x 532.220(V) mm	
6	Screen size	Diagonal 42" Colour Plasma Display Module	
7	Screen aspect	16:9	
8	Display colour	16.77 million colours (8-bit)	
9	Viewing angle	Over 160 deg (angle with 50% and greater brightness perpendicular to PDP module)	
10	Dimensions	1000 (W) x 598 (H) x 64.4 (D) mm	
11	Weight	Module 1	About 20.0 kg
12	Broadc. reception Vertical frequency Video/Logic Interface	60/50 Hz, LVDS	

1.1.7 50" HD v3

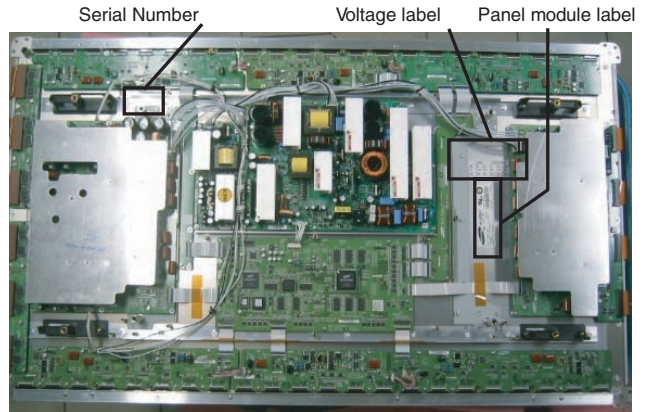

Figure 1-13 External view (50" HD v3)

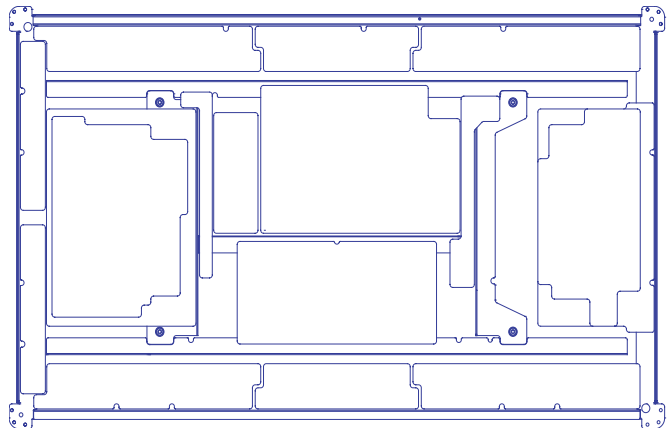
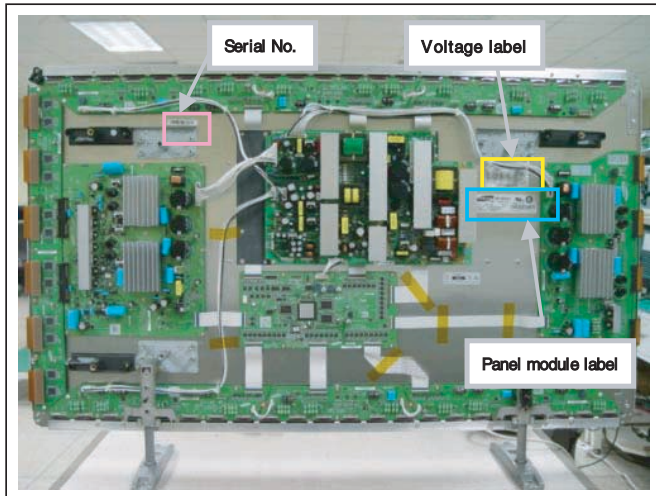

Figure 1-14 Points of screw mount (50" HD v3)

No	Item	Specification 50" HD v3	
1	Pixel	1366 (H) x 768 (V) pixels (1 pixel = 1 R,G,B cells)	
2	Number of Cells	4,098 (H) x 768 (V) cells	
3	Pixel Pitch	0.810mm (H) mm x 0.810 mm (V)	
4	Cell Pitch	R	Horizontal 0.270mm Vertical 0.810mm
		G	Horizontal 0.270mm Vertical 0.810mm
		B	Horizontal 0.270mm Vertical 0.810mm
5	Display size	1106.46 mm (H) x 622.08 mm (H)	
6	Screen size	Diagonal 50" Colour Plasma Display Module	
7	Screen aspect	16:9	
8	Display colour	16.77 million colours	
9	Viewing angle	Over 160 deg (angle with 50% and greater brightness perpendicular to PDP module)	
10	Dimensions	1184 (W) x 700 (H) x 60.1 (D) mm	
11	Weight	Module 1	About 18.0 kg
12	Broadc. reception Vertical frequency Video/Logic Interface	60/50 Hz, LVDS	

1.1.8 50" HD v4



F\_14991\_012.eps 030805

Figure 1-15 External view (50" HD v4)

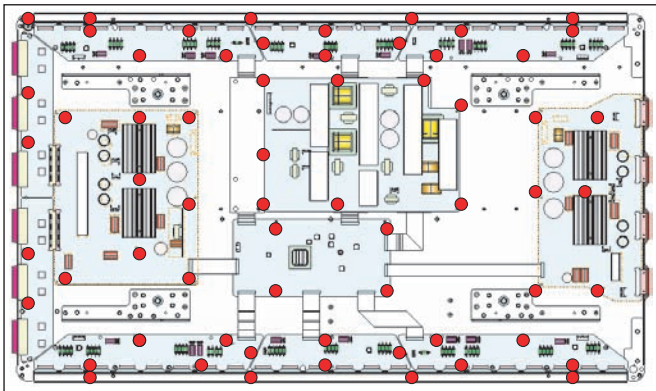

F\_14991\_013.eps 030805

Figure 1-16 Points of screw mount (50" HD v4)

No	Item	Specification 50" HD v4
1	Pixel	1366 (H) x 768 (V) pixels (1 pixel = 1 R,G,B cells)
2	Number of Cells	4,098 (H) x 768 (V) cells
3	Pixel Pitch	0.810mm (H) mm x 0.810 mm (V)
4	Cell Pitch	R Horizontal 0.270mm Vertical 0.810mm G Horizontal 0.270mm Vertical 0.810mm B Horizontal 0.270mm Vertical 0.810mm
5	Display size	1106.46 mm (H) x 622.08 mm (H)
6	Screen size	Diagonal 50" Colour Plasma Display Module
7	Screen aspect	16:9
8	Display colour	16.77 million colours
9	Viewing angle	Over 160 deg (angle with 50% and greater brightness perpendicular to PDP module)
10	Dimensions	1175 (W) x 682 (H) x 65.5 (D) mm
11	Weight	Module 1 About 25.4 kg
12	Broadc. reception Vertical frequency Video/Logic Interface	60/50 Hz, LVDS

1.2 Serial Numbers

Class	14 digits							
ID Type	C	001	A	4	9	03	A	0001
	Area	Model	Module Line	Year	Month	Date	Worker Group	S/N
ID Meaning	① Area (C: Cheonan , S : Shenzhen) ② Model : 3 digit ③ Module Line : A ~ Z ④ Year : 1 Digit => Rotate every decades ⑤ Month (Hex: 1 Digit => Oct - A , Nov - B, Dec - C) ⑥ Date : 1 ~ 31 ⑦ Worker Group : A Part(Day), B Part(Afternoon), C Part(Night)							

F\_14991\_004.eps 180705

Figure 1-17 Module serial number

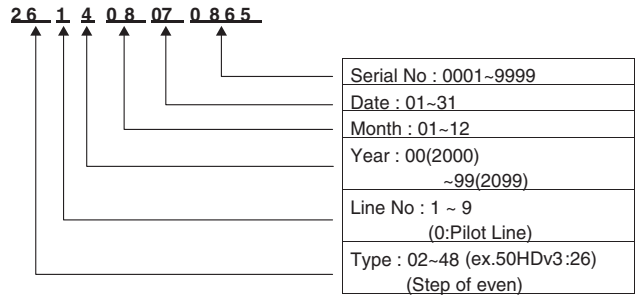
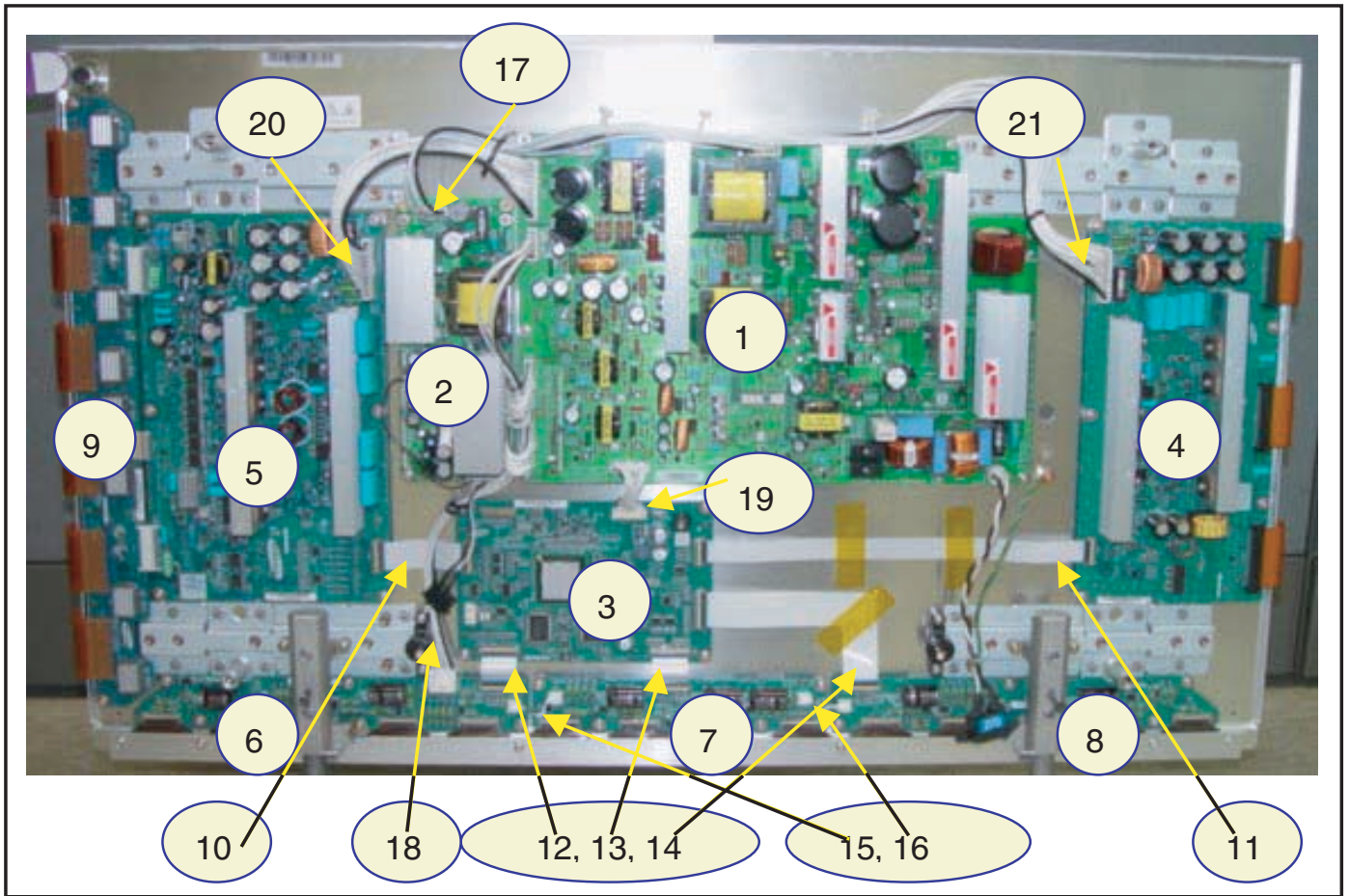

Figure 1-18 Panel serial number

1.3 Chassis Overview

1.3.1 37" SD v4



F\_14991\_027.eps  
030805

Figure 1-19 PWB location (37" SD v4)

Table 1-3 PWB overview (37" SD v4)

No.	Location	Name
1	Main PSU	Assy PWB PSU
2	SUB-PSU	Assy PWB SUB-PSU
3	LOGIC-MAIN Board	Assy PWB LOGIC Main
4	X-MAIN Driving Board	Assy PWB X Main
5	Y-MAIN Driving Board	Assy PWB Y Main
6	LOGIC E BUFFER Board	Assy PWB Buffer
7	LOGIC F BUFFER Board	Assy PWB Buffer
8	LOGIC G BUFFER Board	Assy PWB Buffer
9	Y-BUFFER Board	Assy PWB Buffer
10	LOGIC + Y-MAIN	FFC Cable-flat
11	LOGIC + X-MAIN	FFC Cable-flat
12	LOGIC + LOGIC BUF(E)	FFC Cable-flat
13	LOGIC + LOGIC BUF(F)	FFC Cable-flat
14	LOGIC + LOGIC BUF(G)	FFC Cable-flat
15	LOGIC BUF(E) + LOG. BUF(F)	Lead connector
16	LOGIC BUF(F) + LOG. BUF(G)	Lead connector
17	PSU + SUB PSU	Lead connector
18	PSU + LOGIC BUF(E)	Lead connector
19	PSU + LOGIC MAIN	Lead connector
20	PSU + Y-MAIN	Lead connector

1.3.2 42" SD v2

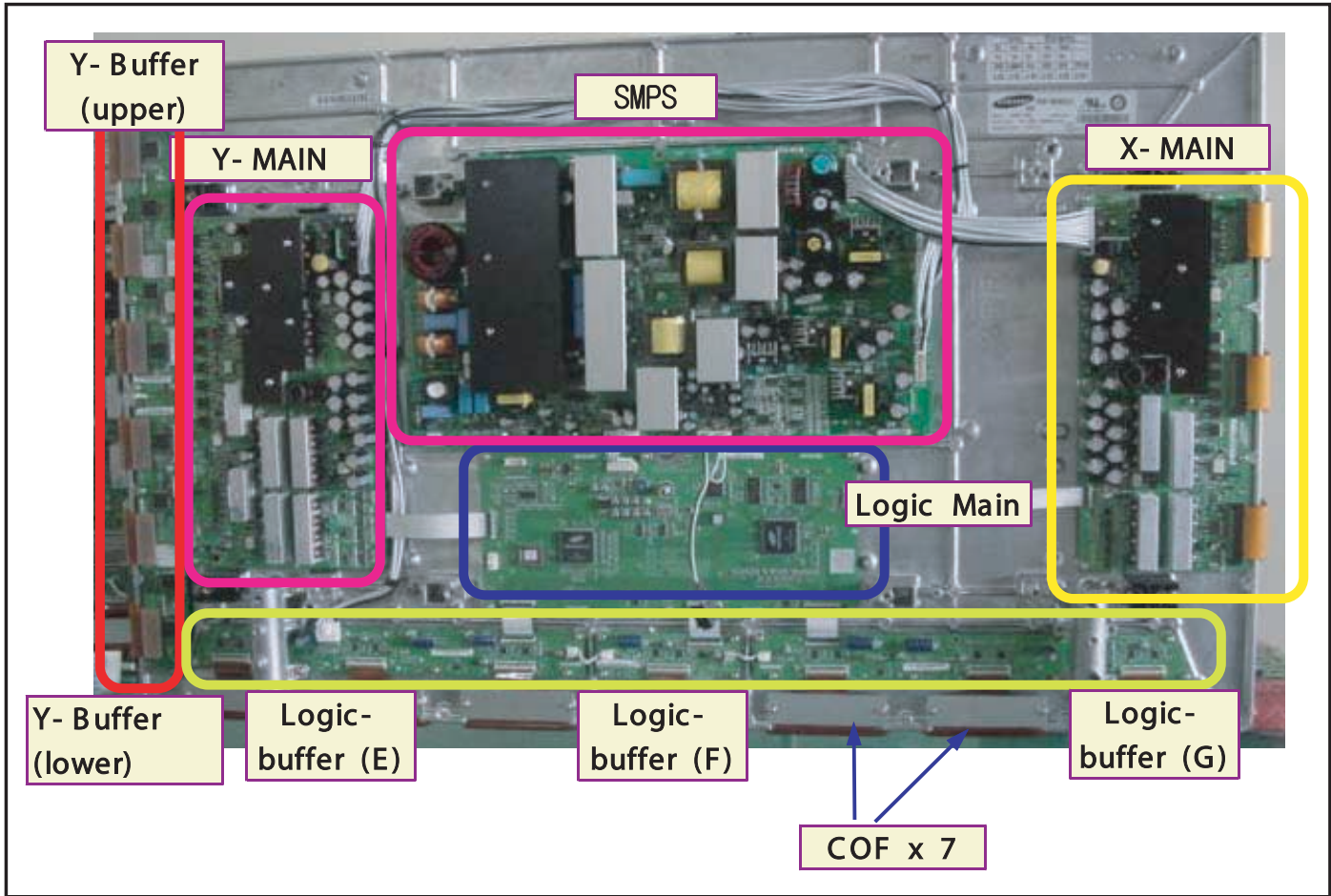

F\_14991\_033.eps  
061005

Figure 1-20 PWB location (42" SD v2)

Table 1-4 PWB overview (42" SD v2)

No.	Location	Name
1	info not available	
2		
3		
4		
5		
6		
7		
8		
9		
10		
11		
12		
13		
14		
15		
16		
17		
18		
19		
20		
21		
22		
23		



1.3.3 42" SD v3

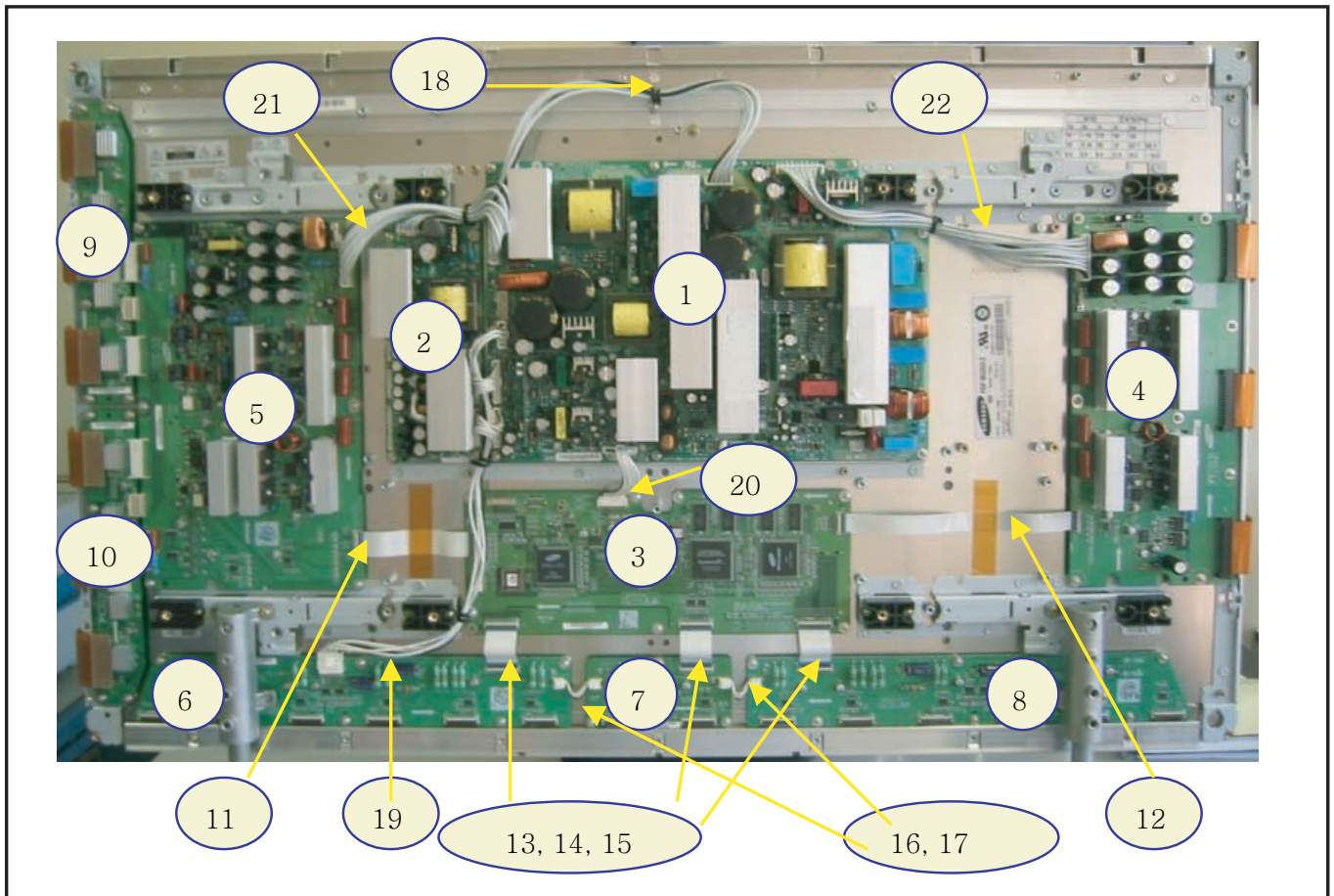

F\_14991\_034.eps  
061005

Figure 1-21 PWB location (42" SD v3)

Table 1-5 PWB overview (42" SD v3)

No.	Location	Name
1	Main PSU	Assy PWB PSU
2	SUB-PSU	Assy PWB SUB-PSU
3	LOGIC-MAIN Board	Assy PWB LOGIC Main
4	X-MAIN Driving Board	Assy PWB X Main
5	Y-MAIN Driving Board	Assy PWB Y Main
6	LOGIC E BUFFER Board	Assy PWB Buffer
7	LOGIC F BUFFER Board	Assy PWB Buffer
8	LOGIC G BUFFER Board	Assy PWB Buffer
9	Y-BUFFER (UPPER) Board	Assy PWB Buffer
10	Y-BUFFER (DOWN) Board	Assy PWB Buffer
11	LOGIC + Y-MAIN	FFC Cable-flat
12	LOGIC + X-MAIN	FFC Cable-flat
13	LOGIC + LOGIC BUF(E)	FFC Cable-flat
14	LOGIC + LOGIC BUF(F)	FFC Cable-flat
15	LOGIC + LOGIC BUF(G)	FFC Cable-flat
16	LOGIC BUF(E) +LOG. BUF(F)	Lead connector
17	LOGIC BUF(F) +LOG. BUF(G)	Lead connector
18	PSU + SUB PSU	Lead connector
19	PSU + LOGIC BUF(E)	Lead connector
20	PSU + LOGIC MAIN	Lead connector
21	PSU + Y-MAIN	Lead connector
22	PSU + X-MAIN	Lead connector

1.3.4 42" SD v4

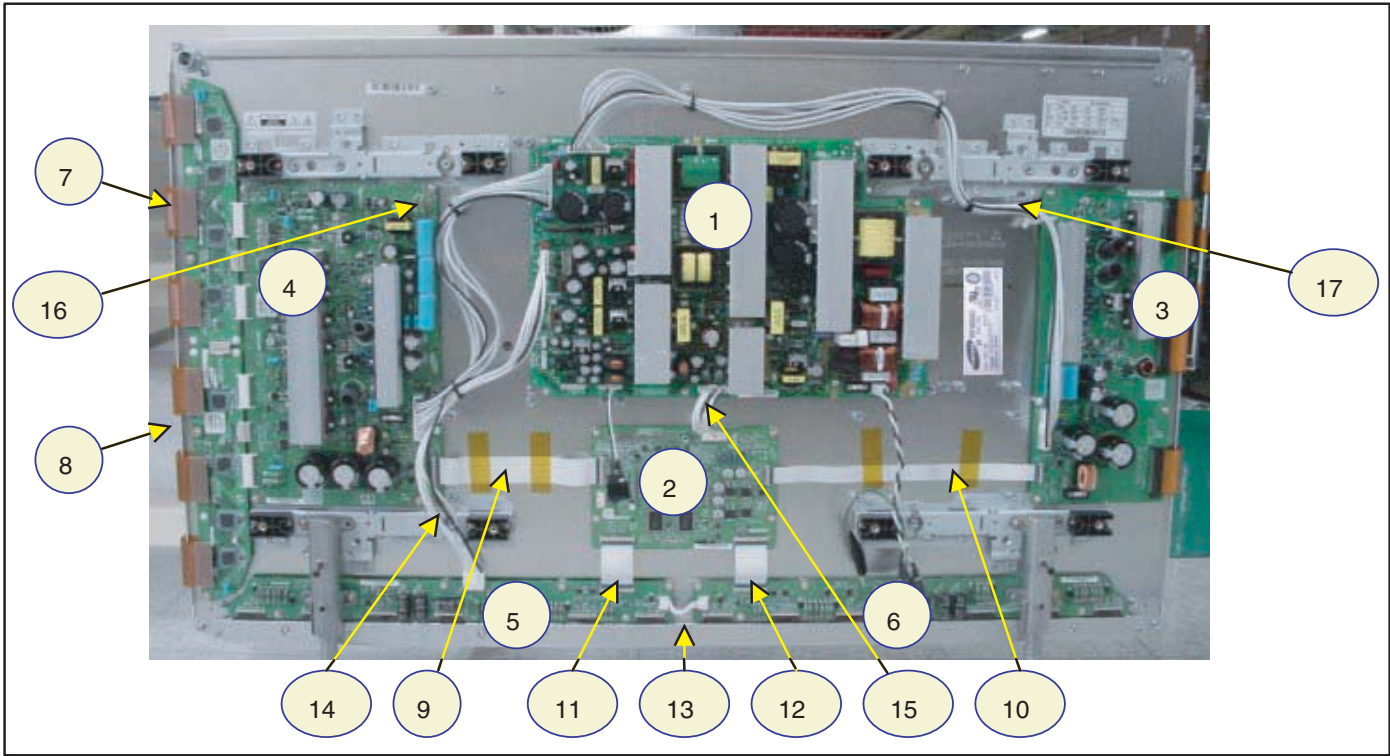

F\_14991\_001.eps  
180705

Figure 1-22 PWB location (42" SD v4)

Table 1-6 PWB overview (42" SD v4)

No.	Location	Name
1	SMPS	SMPS
2	LOGIC-MAIN Board	Assy PWB Logic Main
3	X-MAIN Driving Board	Assy PWB X Main
4	Y-MAIN Driving Board	Assy PWB Y Main
5	LOGIC E BUFFER Board	Assy PWB buffer
6	LOGIC F BUFFER Board	Assy PWB buffer
7	Y-BUFFER (UPPER) Board	Assy PWB buffer
8	Y-BUFFER (DOWN) Board	Assy PWB buffer
9	LOGIC + Y-MAIN	FFC cable-flat
10	LOGIC + X-MAIN	FFC cable-flat
11	LOGIC + LOGIC BUF (E)	FFC cable-flat
12	LOGIC + LOGIC BUF (F)	FFC cable-flat
13	LOGIC BUF (E) + (F)	Lead connector
14	SMPS + LOGIC BUF (E)	Lead connector
15	SMPS + LOGIC MAIN	Lead connector
16	SMPS + Y-MAIN	Lead connector
17	SMPS + X-MAIN	Lead connector

1.3.5 42" HD v3

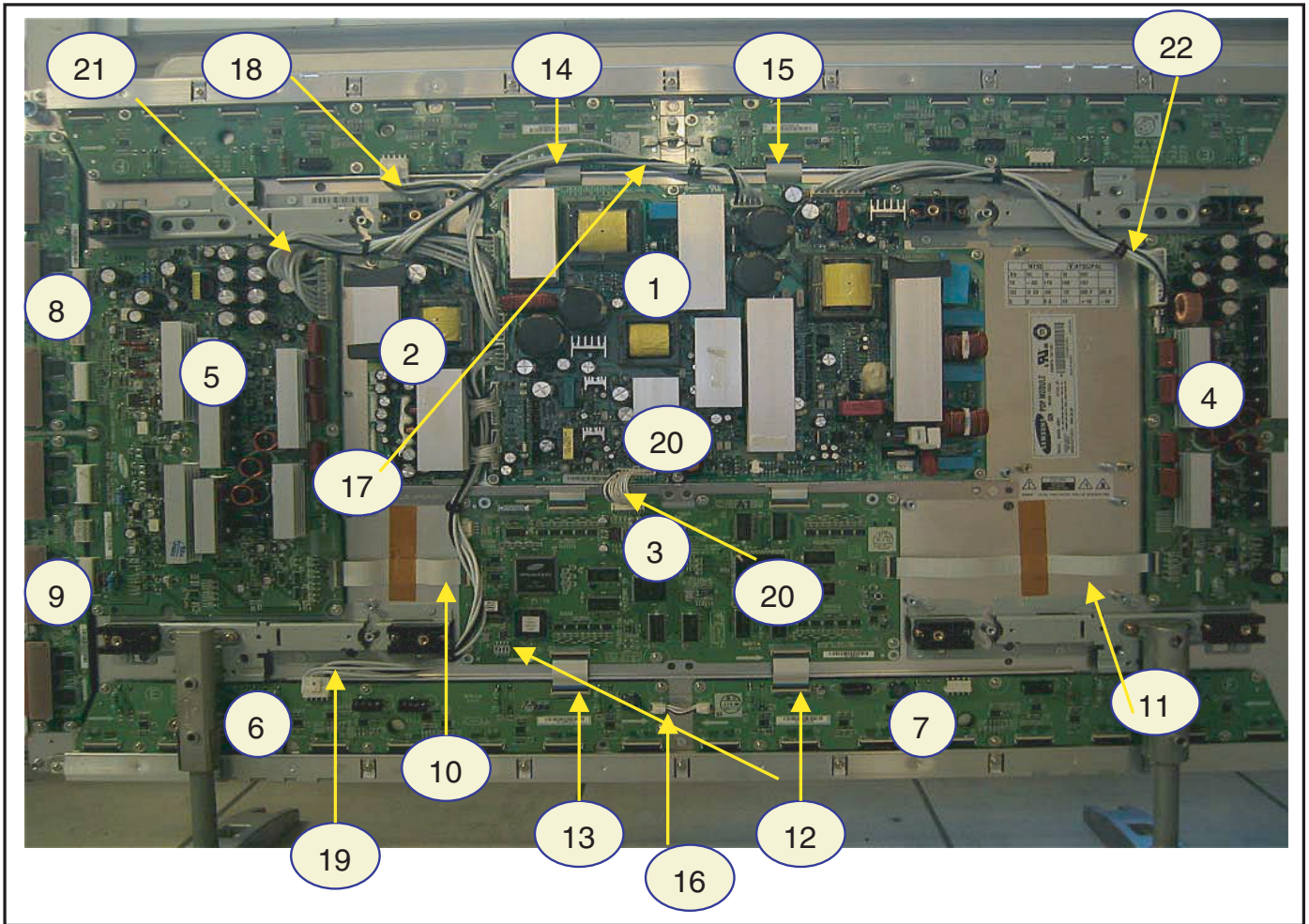

F\_14991\_014.eps  
030805

Figure 1-23 PWB location (42" HD v3)

Table 1-7 PWB overview (42" HD v3)

No.	Location	Name
1	Main PSU	Assy PWB PSU
2	SUB-PSU	Assy PWB SUB-PSU
3	LOGIC-MAIN Board	Assy PWB LOGIC Main
4	X-MAIN Driving Board	Assy PWB X Main
5	Y-MAIN Driving Board	Assy PWB Y Main
6	LOGIC E BUFFER Board	Assy PWB Buffer
7	LOGIC F BUFFER Board	Assy PWB Buffer
8	Y-BUFFER (UPPER) Board	Assy PWB BufferR
9	Y-BUFFER (DOWN) Board	Assy PWB Buffer
10	LOGIC + Y-MAIN	FFC Cable-flat
11	LOGIC + X-MAIN	FFC Cable-flat
12	LOGIC + LOG. BUF(E) (Down)	FFC Cable-flat
13	LOGIC + LOG. BUF(F) (Down)	FFC Cable-flat
14	LOGIC + LOGIC BUF(E) (Up)	FFC Cable-flat
15	LOGIC + LOGIC BUF(E) (Up)	FFC Cable-flat
16	LOGIC BUF(E) + LOG. BUF(F)	Lead connector
17	PSU + SUB PSU	Lead connector
18	PSU + LOGIC BUF(E) (UP)	Lead connector
19	PSU + LOGIC BUF(E) (Down)	Lead connector
20	PSU + LOGIC MAIN	Lead connector
21	PSU + Y-MAIN	Lead connector
22	PSU + X-MAIN	Lead connector

1.3.6 42" HD v4

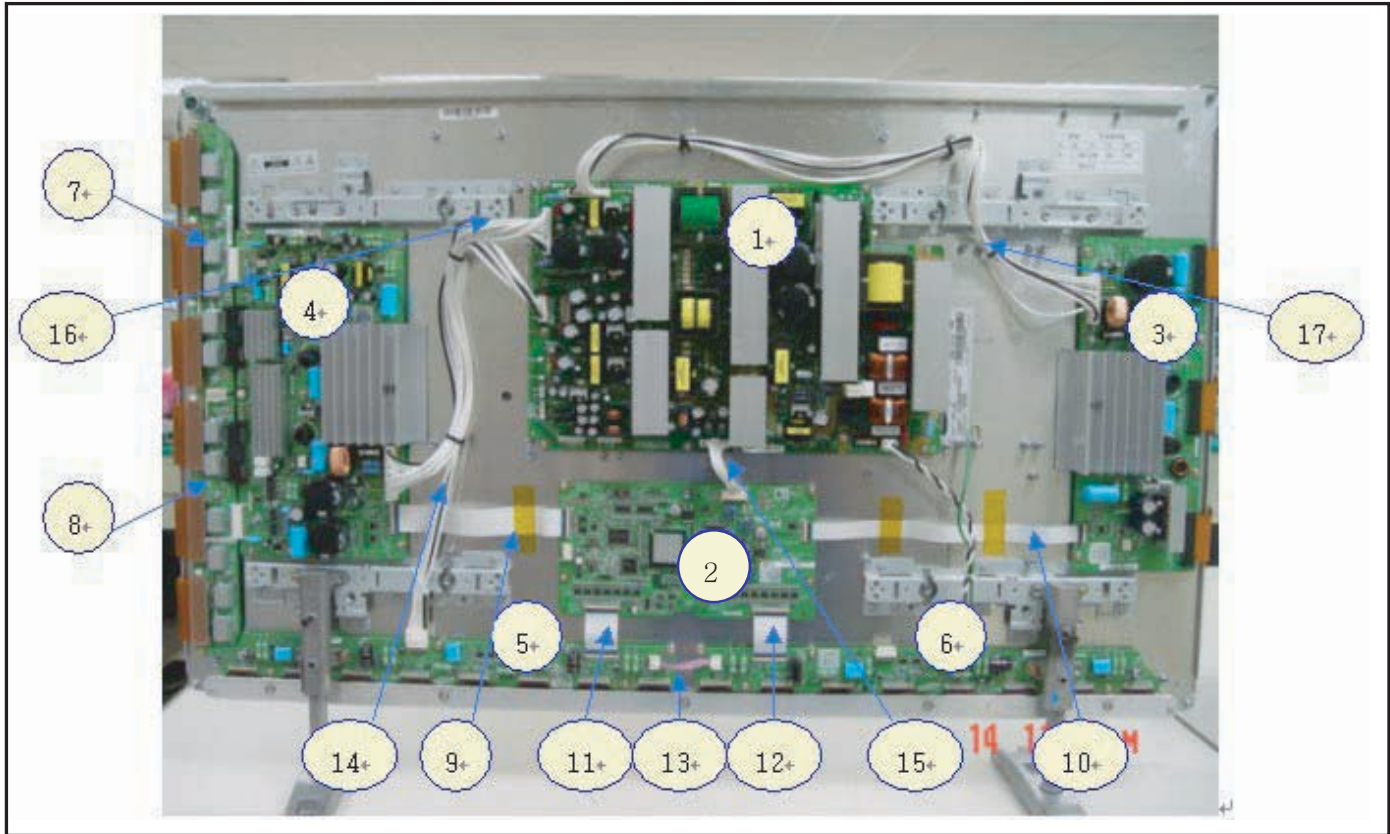

F\_14991\_015.eps  
030805

Figure 1-24 PWB location (42" HD v4)

Table 1-8 PWB overview (42" HD v4)

No.	Location	Name
1	SMPS	SMPS
2	LOGIC-MAIN Board	Assy PWBLOGIC Main
3	X-MAIN Driving Board	Assy PWBX Main
4	Y-MAIN Driving Board	Assy PCBY Main
5	LOGIC E BUFFER Board	Assy PWB Buffer
6	LOGIC F BUFFER Board	Assy PWB Buffer
7	Y-BUFFER (UPPER) Board	Assy PWB Buffer
8	Y-BUFFER (DOWN) Board	Assy PWB Buffer
9	LOGIC + Y-MAIN	FFC Cable-flat
10	LOGIC + X-MAIN	FFC Cable-flat
11	LOGIC + LOGIC BUF(E)	FFC Cable-flat
12	LOGIC + LOGIC BUF(F)	FFC Cable-flat
13	LOGIC BUF(E) + LOG. BUF(F)	Lead connector
14	SMPS + LOGIC BUF(E)	Lead connector
15	SMPS + LOGIC MAIN	Lead connector
16	SMPS + Y-MAIN	Lead connector
17	SMPS + X-MAIN	Lead connector

1.3.7 50" HD v3

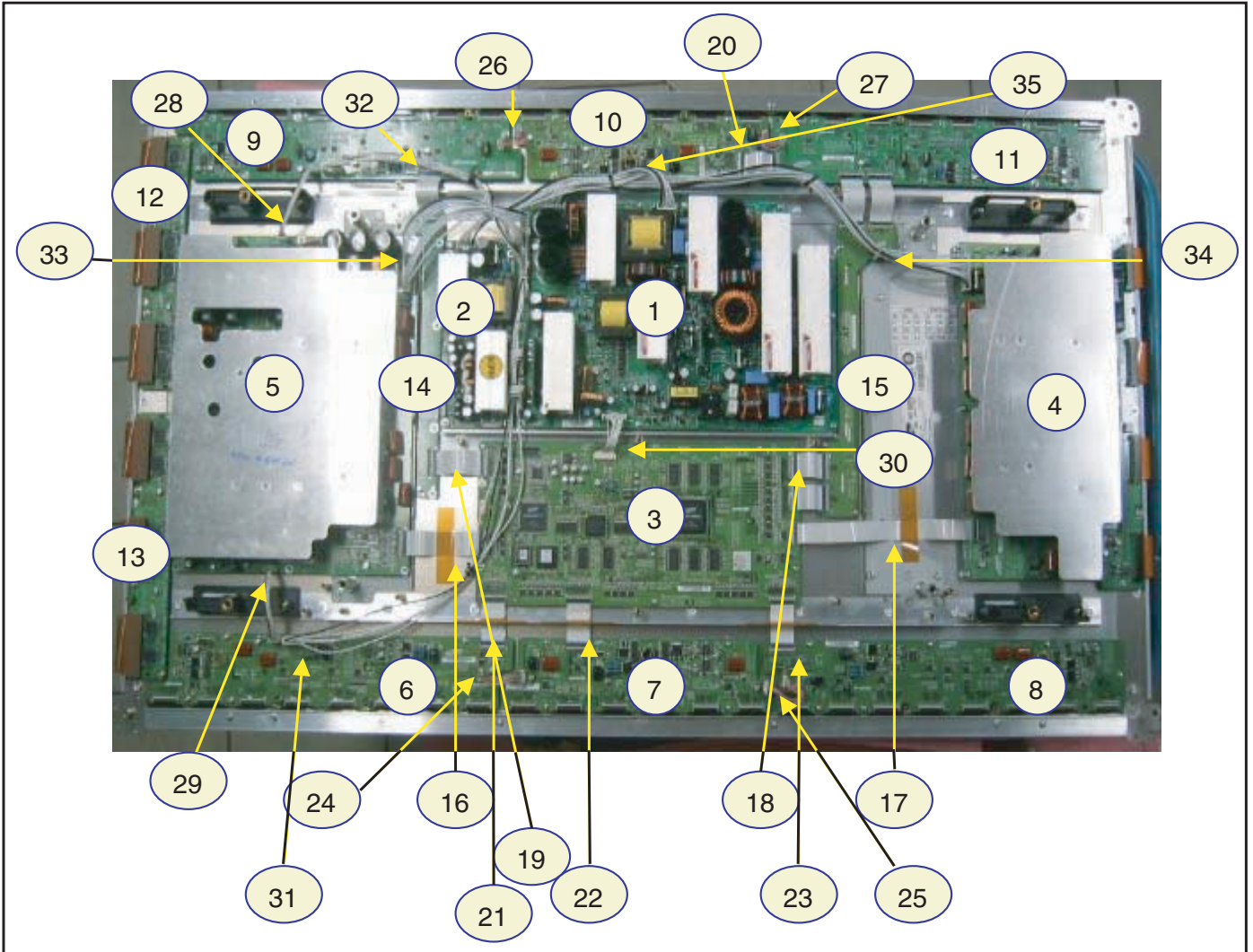

F\_14991\_016.eps  
030805

Figure 1-25 PWB location (50" HD v3)

Table 1-9 PWB overview (50" HD v3)

No.	Location	Name
1	Main PUS	Assy PWBPSU
2	SUB-PSU	Assy PWB SUB-PSU
3	LOGIC-MAIN Board	Assy PWB LOGIC Main
4	X-MAIN Driving Board	Assy PWB X-Main
5	Y-MAIN Driving Board	Assy PWB Y-Main
6	LOGIC E BUFFER Board	Assy PWB Buffer
7	LOGIC F BUFFER Board	Assy PWB Buffer
8	LOGIC G BUFFER Board	Assy PWB Buffer
9	LOGIC H BUFFER Board	Assy PWB Buffer
10	LOGIC I BUFFER Board	Assy PWB Buffer
11	LOGIC J BUFFER Board	Assy PWB Buffer
12	Y-BUFFER (UPPER) Board	Assy PWB Buffer
13	Y-BUFFER (DOWN) Board	Assy PWB Buffer
14	SUB-R	Assy PWB Buffer
15	SUB-L	Assy PWB Buffer
16	LOGIC + Y-MAIN	FFC Cable-flat
17	LOGIC + X-MAIN	FFC Cable-flat
18	SUB R + LOGIC	FFC Cable-flat
19	SUB L + LOGIC	FFC Cable-flat
20	LOG.BUF(I) + LOG.BUF(J) (Up)	FFC Cable-flat
21	LOGIC + LOG. BUF(E) (Down)	FFC Cable-flat

No.	Location	Name
22	LOGIC + LOG. BUF(F) (Down)	FFC Cable-flat
23	LOGIC + LOG. BUF(G) (Down)	FFC Cable-flat
24	LOGIC BUF(E) + LOG. BUF(F)	Lead connector
25	LOGIC BUF(F) + LOG. BUF(G)	Lead connector
26	LOGIC BUF(H) + LOG. BUF(I)	Lead connector
27	LOGIC BUF(I) + LOG. BUF(J)	Lead connector
28	Y-MAIN + LOGIC BUF(H)	Lead connector
29	Y-MAIN + LOGIC BUF(E)	Lead connector
30	PSU + LOGIC MAIN	Lead connector
31	PSU + LOGIC BUF(E)	Lead connector
32	PSU + LOGIC BUF(H)	Lead connector
33	PSU + Y-MAIN	Lead connector
34	PSU + X-MAIN	Lead connector
35	PSU + SUB PSU	Lead connector

1.3.8 50" HD v4

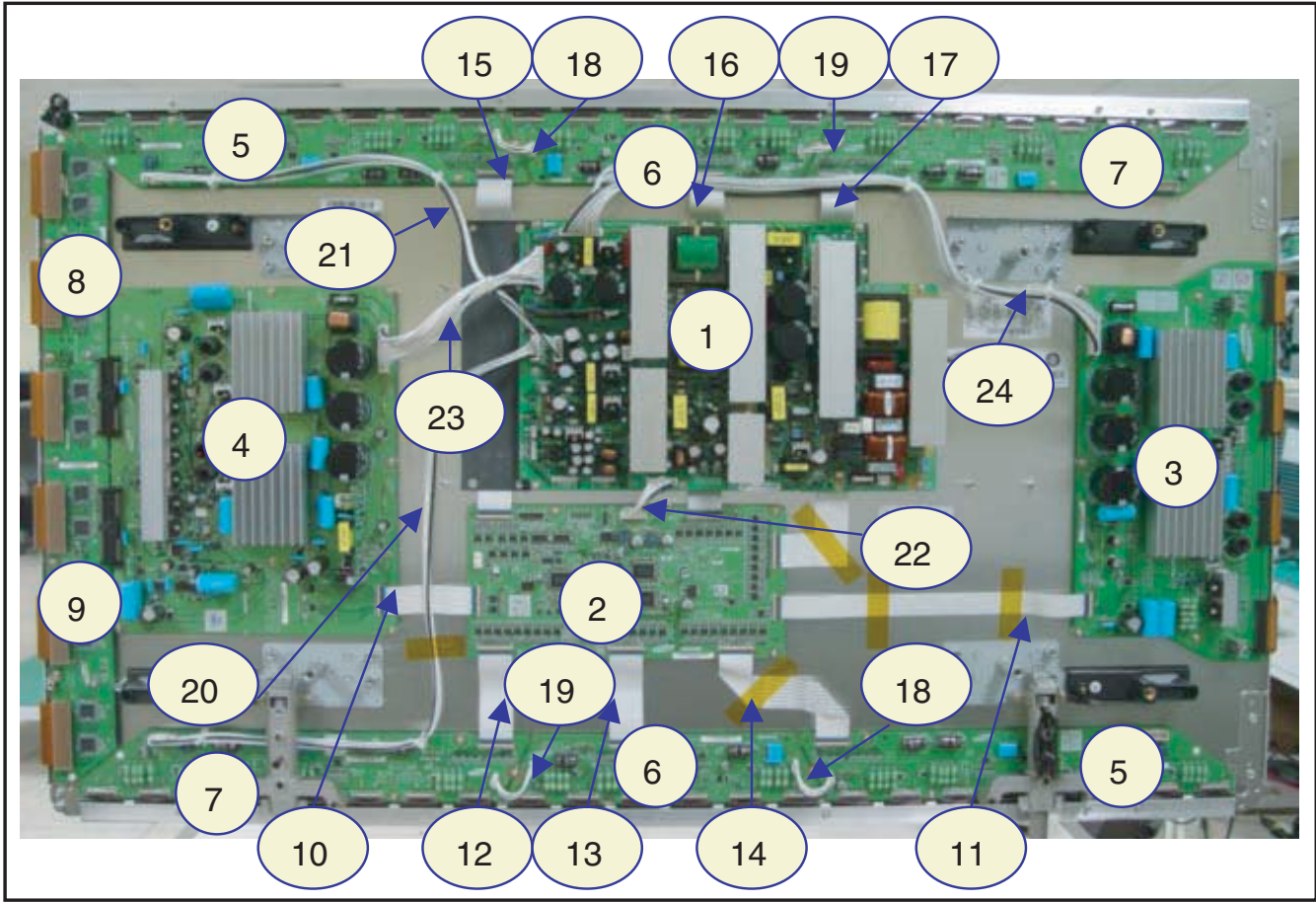

F\_14991\_017.eps  
030805

Figure 1-26 PWB location (50" HD v4)

Table 1-10 PWB overview (50" HD v4)

No.	Location	Name
1	SMPS	SMPS
2	LOGIC-MAIN Board	Assy PWBLOGIC Main
3	X-MAIN Driving Board	Assy PWBX Main
4	Y-MAIN Driving Board	Assy PCBY Main
5	LOGIC E BUFFER Board	Assy PWB Buffer
6	LOGIC F BUFFER Board	Assy PWB Buffer
7	LOGIC G BUFFER Board	Assy PWB Buffer
8	Y-BUFFER (Upper) Board	Assy PWB Buffer
9	Y-BUFFER (Down) Board	Assy PWB Buffer
10	LOGIC + Y-MAIN	FFC Cable-flat
11	LOGIC + X-MAIN	FFC Cable-flat
12	LOGIC + LOG. BUF(G: Down)	FFC Cable-flat
13	LOGIC + LOG. BUF(F: Down)	FFC Cable-flat
14	LOGIC + LOG. BUF(E: Down)	FFC Cable-flat
15	LOGIC + LOG. BUF(E: Upper)	FFC Cable-flat
16	LOGIC + LOG. BUF(F: Upper)	FFC Cable-flat
17	LOGIC + LOG. BUF(G: Upper)	FFC Cable-flat
18	LOGIC BUF(E) + LOG. BUF(F)	Lead connector
19	LOGIC BUF(F) + LOG. BUF(G)	Lead connector
20	SMPS + LOGIC BUF(G: Down)	Lead connector
21	SMPS + LOGIC BUF(E: Upper)	Lead connector
22	SMPS + LOGIC MAIN	Lead connector
23	SMPS + Y-MAIN	Lead connector
24	SMPS + X-MAIN	Lead connector

## 2. Safety Instructions, Warnings, and Notes

### Index of this chapter:

- 2.1 Handling Precautions
- 2.2 Safety Precautions
- 2.3 Notes

### Notes:

- Only authorised persons should perform servicing of this module.
- When using/handling this unit, pay special attention to the PDP Module: it should not be enforced into any other way than next rules, warnings, and/or cautions.
- **"Warning"** indicates a hazard that may lead to death or injury if the warning is ignored and the product is handled incorrectly.
- **"Caution"** indicates a hazard that can lead to injury or damage to property if the caution is ignored and the product is handled incorrectly.

### 2.1 Handling Precautions

- The PDP module use high voltage that is dangerous to humans. Before operating the PDP, always check for dust to prevent short circuits. Be careful touching the circuit device when power is "on".
- The PDP module is sensitive to dust and humidity. Therefore, assembling and disassembling must be done in no dust place.
- The PDP module has a lot of electric devices. The service engineer must wear equipment (for example, earth ring) to prevent electric shock and working clothes to prevent electrostatic.
- The PDP module use a fine pitch connector which is only working by exactly connecting with flat cable. The operator must pay attention to a complete connection when connector is reconnected after repairing.
- The capacitor's remaining voltage in the PDP module's circuit board temporarily remains after power is "off". Operator must wait for discharging of remaining voltage during at least 1 minute.

### 2.2 Safety Precautions

#### 2.2.1 Safety Precautions

- Before replacing a board, discharge forcibly.
- The remaining electricity from board.
- When connecting FFC and TCPs to the module, recheck that they are perfectly connected.
- To prevent electrical shock, be careful not to touch leads during circuit operations.
- To prevent the Logic circuit from being damaged due to wrong working, do not connect/disconnect signal cables during circuit operations.
- Do thoroughly adjustment of a voltage label and voltage-insulation.
- Before reinstalling the chassis and the chassis assembly, be sure to use all protective stuff including a nonmetal controlling handle and the covering of partitioning type.
- Caution for design change: Do not install any additional devices to the module, and do not change the electrical circuit design.
- For example: Do not insert a subsidiary audio or video connector. If you insert it, it cause danger on safety. And, if you change the design or insert, manufacturer guarantee will be not effect.
- If any parts of wire is overheats of damaged, replace it with a new specified one immediately, and identify the cause of the problem and remove the possible dangerous factors.
- Examine carefully the cable status if it is twisted or damaged or displaced. Do not change the space between

parts and circuit board. Check the cord of AC power preparing damage.

- Product Safety Mark: Some of electric or implement material have special characteristics invisible that was related on safety. In case of the parts are changed with new one, even though the Voltage and Watt is higher than before, the Safety and Protection function will be lost.
- The AC power always should be turned "off", before next repair.
- Check assembly condition of screw, parts and wire arrangement after repairing. Check whether the material around the parts get damaged.

#### 2.2.2 ESD Precautions

There are parts, which are easily damaged by electrostatics (for example Integrated Circuits, FETs, etc.) Electrostatic damage rate of product will be reduced by the following technics:

- Before handling semiconductor parts/assembly, must remove positive electric by ground connection, or must wear the antistatic wrist-belt and ring (it must be operated after removing dust on it. It comes under precaution of electric shock).
- After removing the assembly, lay it with the tracks on a conductive surface to prevent charging.
- Do not use chemical stuff containing Freon. It generates positive electric that can damage ESD sensitive devices.
- You must use a soldering device for ground-tip when soldering or de-soldering these devices.
- You must use anti-static solder removal device. Most removal devices do not have antistatic which can charge a enough positive electric enough for damaging these devices.
- Before removing the protective material from the lead of a new device, bring the protective material into contact with the chassis or assembly.
- When handing an unpacked device for replacement, do not move around too much. Moving (legs on the carpet, for example) generates enough electrostatic to damage the device.
- Do not take a new device from the protective case until the it is ready to be installed. Most devices have a lead, which is easily short-circuited by conductive materials (such as conductive foam and aluminium)

### 2.3 Notes

A glass plate is positioned before the plasma display. This glass plate can be cleaned with a slightly humid cloth. If due to circumstances there is some dirt between the glass plate and the plasma display panel, it is recommended to do some maintenance by a qualified service employee only.

#### 2.3.1 Safe PDP Handling

- The work procedures shown with the "Note" indication are important for ensuring the safety of the product and the servicing work. Be sure to follow these instructions.
- Before starting the work, secure a sufficient working space.
- At all times, other than when adjusting and checking the product, be sure to turn "off" the main POWER switch and disconnect the power cable from the power source of the display (jig or the display itself) during servicing.
- To prevent electric shock and breakage of PWBs, start the servicing work at least 30 seconds after the main power has been turned "off". Especially when installing and removing the Power Supply PWB and the SUS PWB in which high voltages are applied, start servicing at least 2 minutes after the main power has been turned "off".

- While the main power is “on”, do not touch any parts or circuits other than the ones specified. The high voltage Power Supply block within the PDP module has a floating ground. If any connection other than the one specified is made between the measuring equipment and the high voltage power supply block, it can result in electric shock or activation of the leakage-detection circuit breaker.
- When installing the PDP module in, and removing it from the packing carton, be sure to have at least two persons perform the work while being careful to ensure that the flexible printed-circuit cable of the PDP module does not get caught by the packing carton.
- When the surface of the panel comes into contact with the cushioning materials, be sure to confirm that there is no foreign matter on top of the cushioning materials before the surface of the panel comes into contact with the cushioning materials. Failure to observe this precaution may result in, the surface of the panel being scratched by foreign matter.
- When handling the circuit PWB, be sure to remove static electricity from your body before handling the circuit PWB.
- Be sure to handle the circuit PWB by holding the large parts as the heat sink or transformer. Failure to observe this precaution may result in the occurrence of an abnormality in the soldered areas.
- Do not stack the circuit PWB. Failure to observe this precaution may result in problems resulting from scratches on the parts, the deformation of parts, and short-circuits due to residual electric charge.
- Routing of the wires and fixing them in position must be done in accordance with the original routing and fixing configuration when servicing is completed. All the wires are routed far away from the areas that become hot (such as the heat sink). These wires are fixed in position with the wire clamps so that the wires do not move, thereby ensuring that they are not damaged and their materials do not deteriorate over long periods of time. Therefore, route the cables and fix the cables to the original position and states using the wire clamps.
- Perform a safety check when servicing is completed. Verify that the peripherals of the serviced points have not undergone any deterioration during servicing. Also verify that the screws, parts and cables removed for servicing purposes have all been returned to their proper locations in accordance with the original

### 3. Directions For Use

Not applicable.



## 4. Mechanical Instructions

### Index of this chapter:

- 4.1 Dis-assembling / Re-assembling
- 4.1.1 Flexible Printed Circuit of Y-Buffer (Upper and Lower)
- 4.1.2 Flat Cable Connector of X-main Board
- 4.1.3 FFC and TCP from Connector
- 4.1.4 Exchange of LBE, LBF, LBG board
- 4.1.5 Exchange YBU, YBL and YM board

### 4.1 Dis-assembling / Re-assembling

#### 4.1.1 Flexible Printed Circuit of Y-Buffer (Upper and Lower)

- Dis-assembly: Pull out the FPC from the connector by holding the lead of the FPC with both hands.
- Re-assembly: Push the lead of FPC with same force on both sides into the connector.

**Note:** Be careful do not to damage the connector pin during connecting.

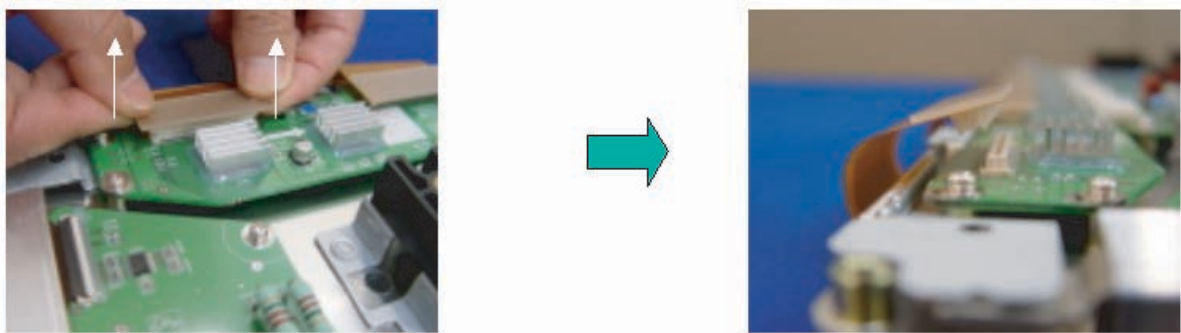

Figure 4-1 Dis-assembly FPC of Y-buffer

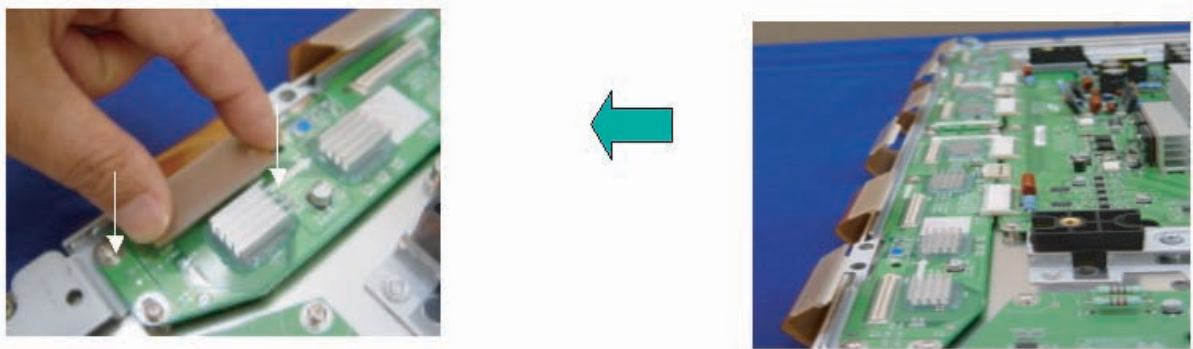

Figure 4-2 Re-assembly FPC of Y-buffer

#### 4.1.2 Flat Cable Connector of X-main Board

- Dis-assembly:
  1. Pull out the clamp of connector.
  2. Pull Flat cable out press down lightly.
  3. Turn the Flat Cable reversely.
- Re-assembly: Put the Flat Cable into the connector press down lightly until locking sound ("Click") comes out.

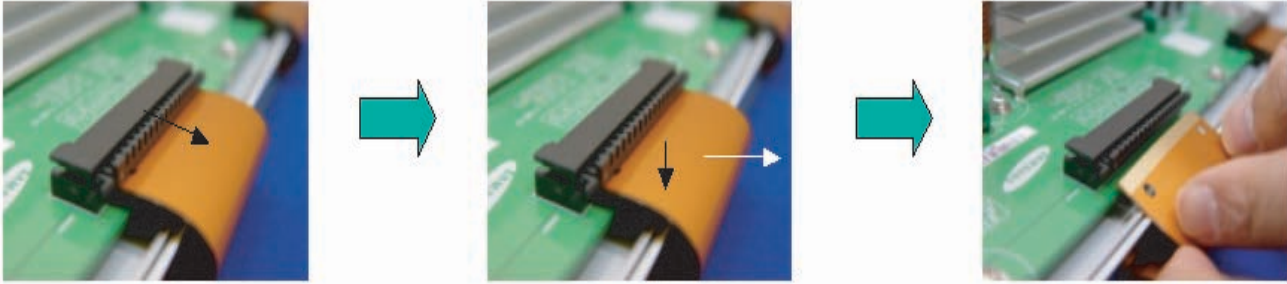

Figure 4-3 Dis-assembly FCC of X-main board

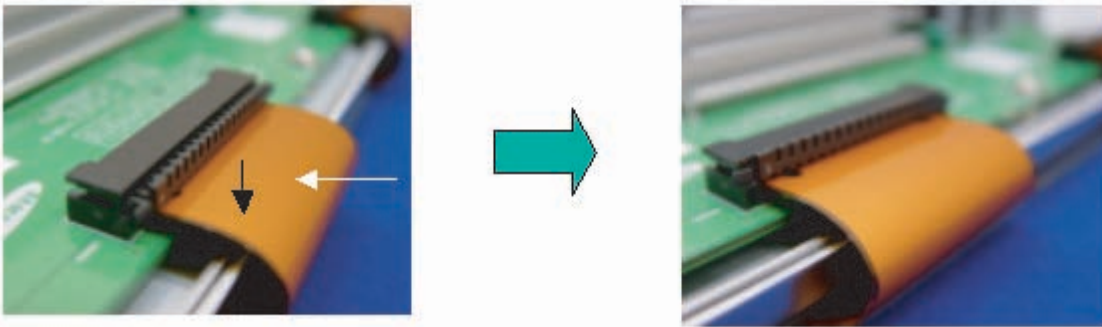

Figure 4-4 Re-assembly FCC of X-main board

### 4.1.3 FFC and TCP from Connector

- Dis-assembly of TCP:
  1. Open the clamp carefully.
  2. Pull the TCP out from its connector.
- Re-assembly of TCP:
  1. Put the TCP into the connector carefully
  2. Close the clamp completely (until "Click" comes out.).

#### Notes:

- Checking whether the foreign material is on the connector inside before assembling of TCP.
- Be careful, do not damage the board by ESD during handling of TCP.

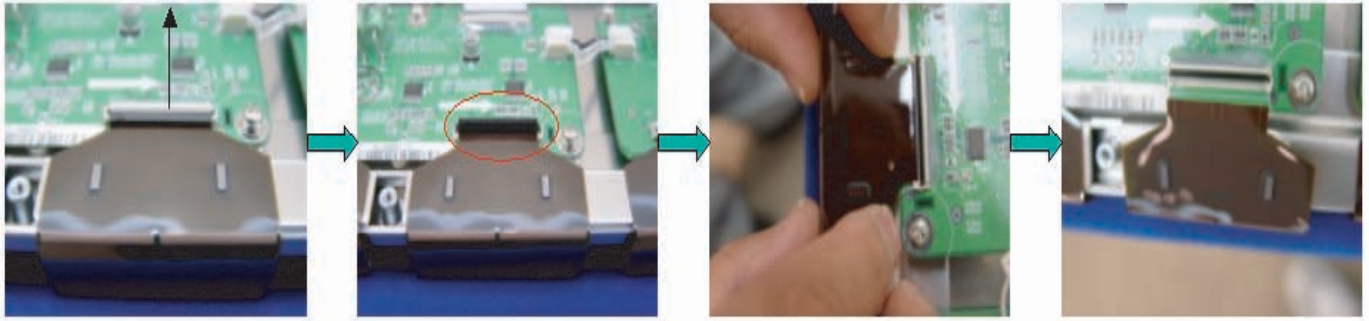

Figure 4-5 Dis-assembly of TCP

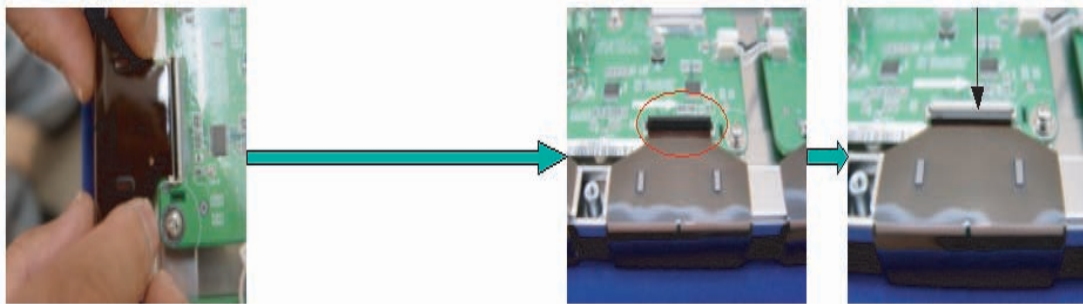

Figure 4-6 Re-assembly of TCP

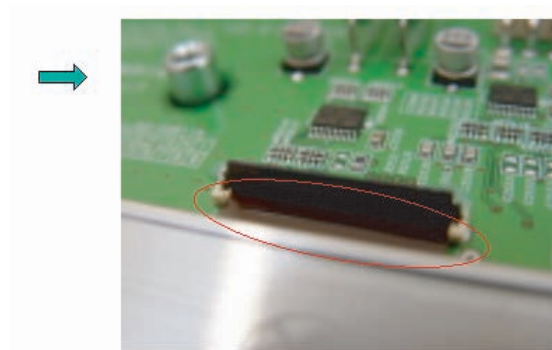

Figure 4-7 Mis-assembly of TCP

The procedure of assembling and disassembling of FFC is same as TCP

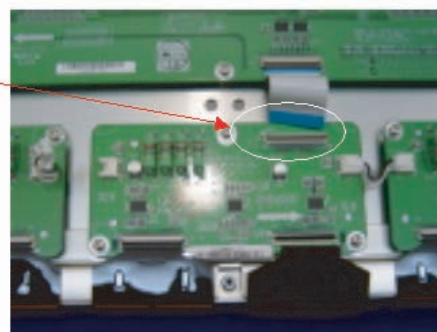

Figure 4-8 Dis- and re-assembly of FFC

#### 4.1.4 Exchange of LBE, LBF, LBG board

1. Depending on the model (see "Photo 2" per model.):
  - **42" SD v3** - Remove the screws in order of 2-3-5-7-1-4-6 (and 10-11-13-16-9-12-14 for HD) from heat sink and then remove heat sink (Photo 1).
  - **42" SD v4** - Remove the screws in order of 2-4-1-5-3 from heat sink and then remove heat sink (Photo 1).
  - **42" HD v3, 37" SD v4, 50" HD v3** - Remove the screws in order of "Centre - Left Side - Right Side" from heat sink and then get rid of heat sink (Photo 1).
  - **50" HD v4** - Remove the screws in order of 2-3-1-4 from heat sink and then remove heat sink (Photo 1).
2. Remove the TPC, FFC, and power cable from the connectors.
3. Remove all the screws from the defective board.
4. Remove the defected board.  
**Note:** When replacing the Logic board or Y-main board for a lead-free (Pb-free) board, always replace them together. (this is **only** valid for the 37" SD v4 displays!)
5. Replace the new board and then screw tightly.
6. Clean the connectors.
7. Re-connect the TCP, FFC, and power cable to the connector.
8. Re-assemble the TCP heat sink. Use the same screw mounting order as described above

**Caution:** If you screw too tight, it is possible to damage the Driver IC of the TCP.



Figure 4-9 Photo 1 - Heatsink removal

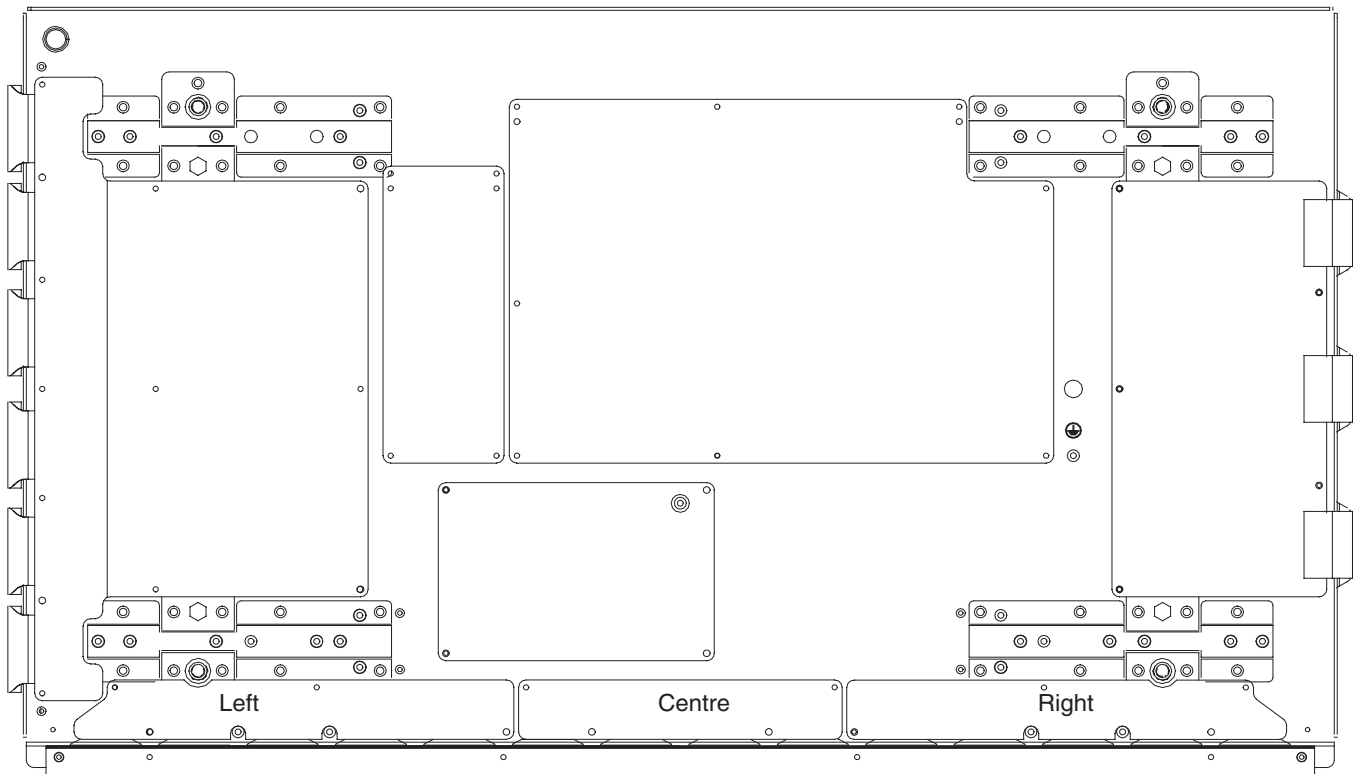

Figure 4-10 Photo 2 - 37" SD v4

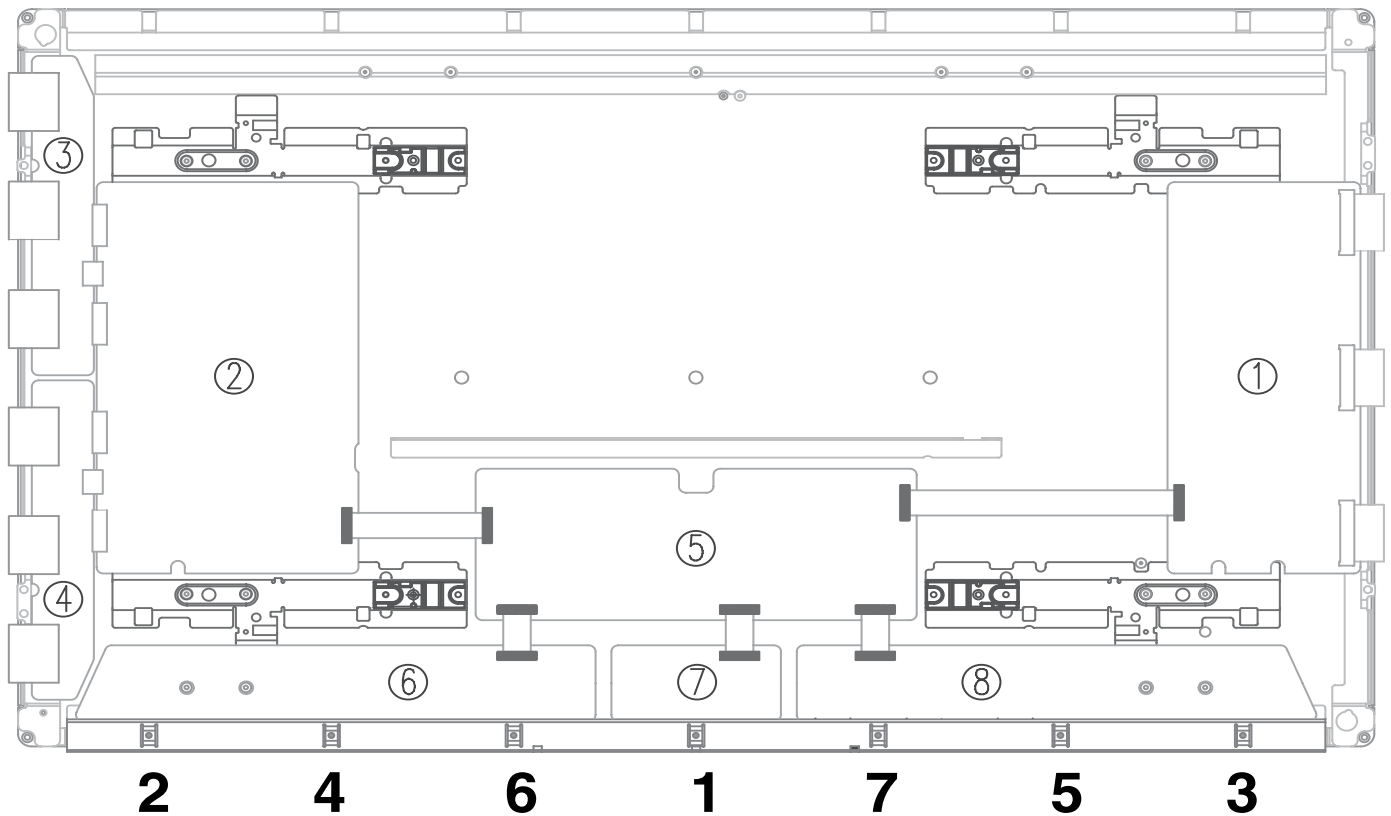
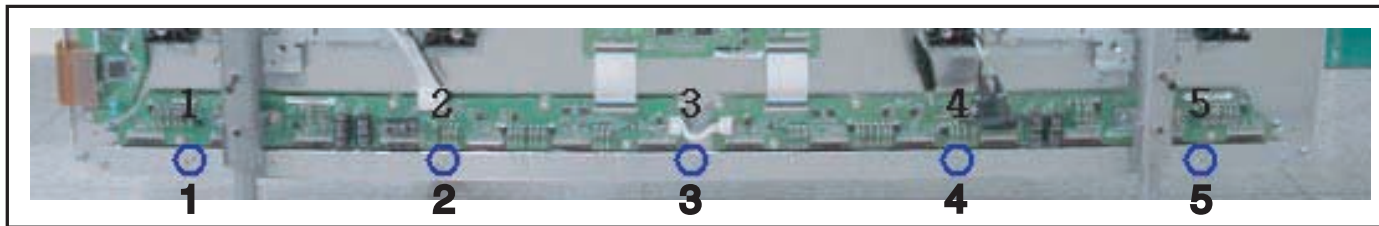

Figure 4-11 Photo 2 - 42" SD v2 and v3



F\_14991\_028.eps  
030805

Figure 4-12 Photo 2 - 42" SD v4

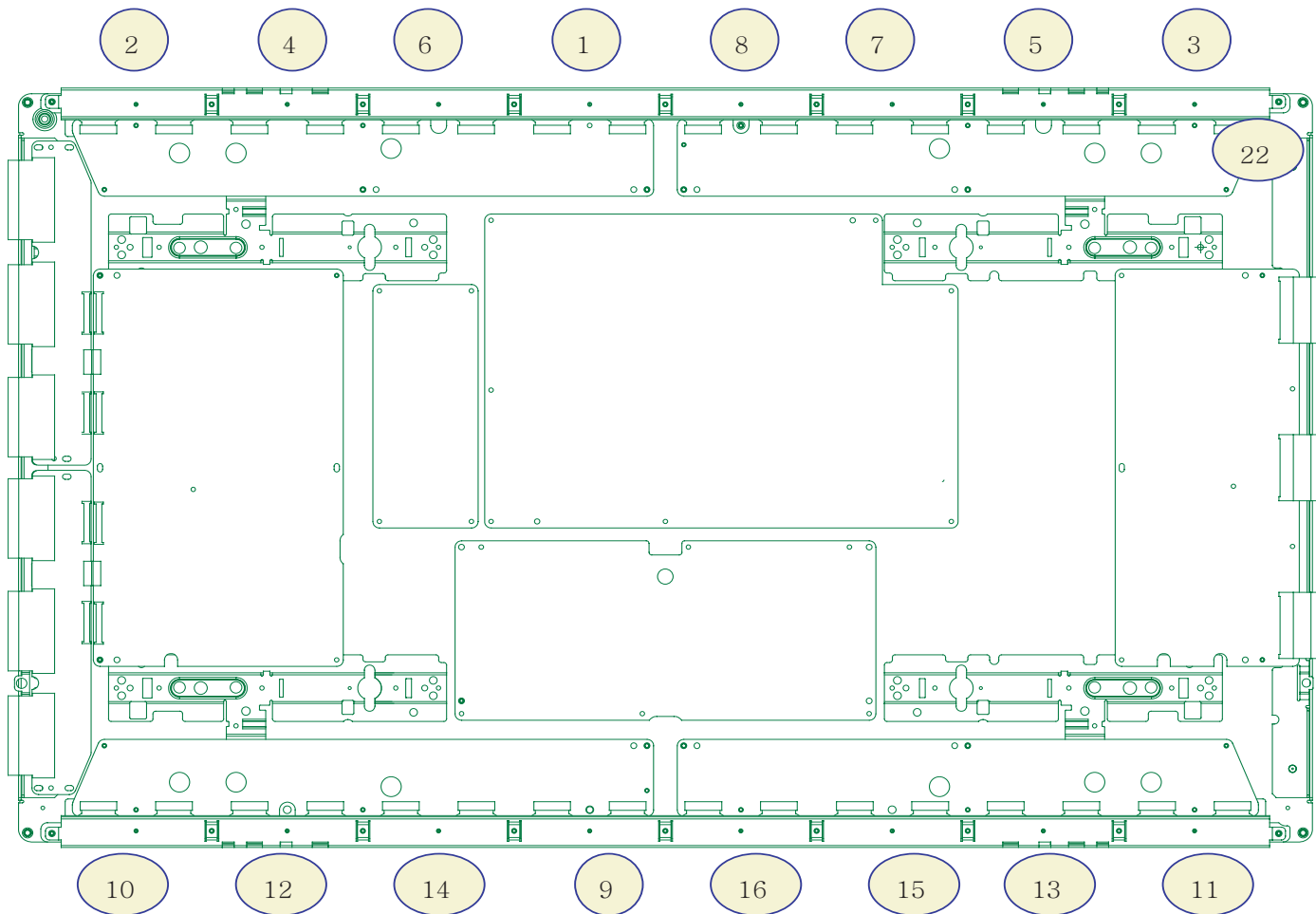
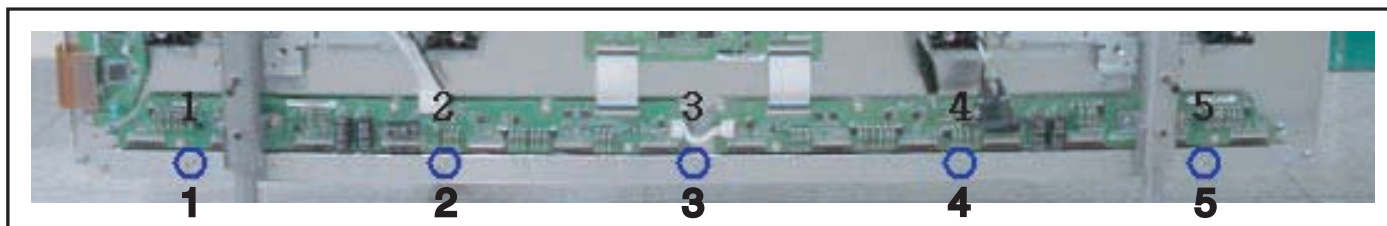

Figure 4-13 Photo 2 - 42" HD v3



F\_14991\_028.eps  
030805

Figure 4-14 Photo 2 - 42" HD v4

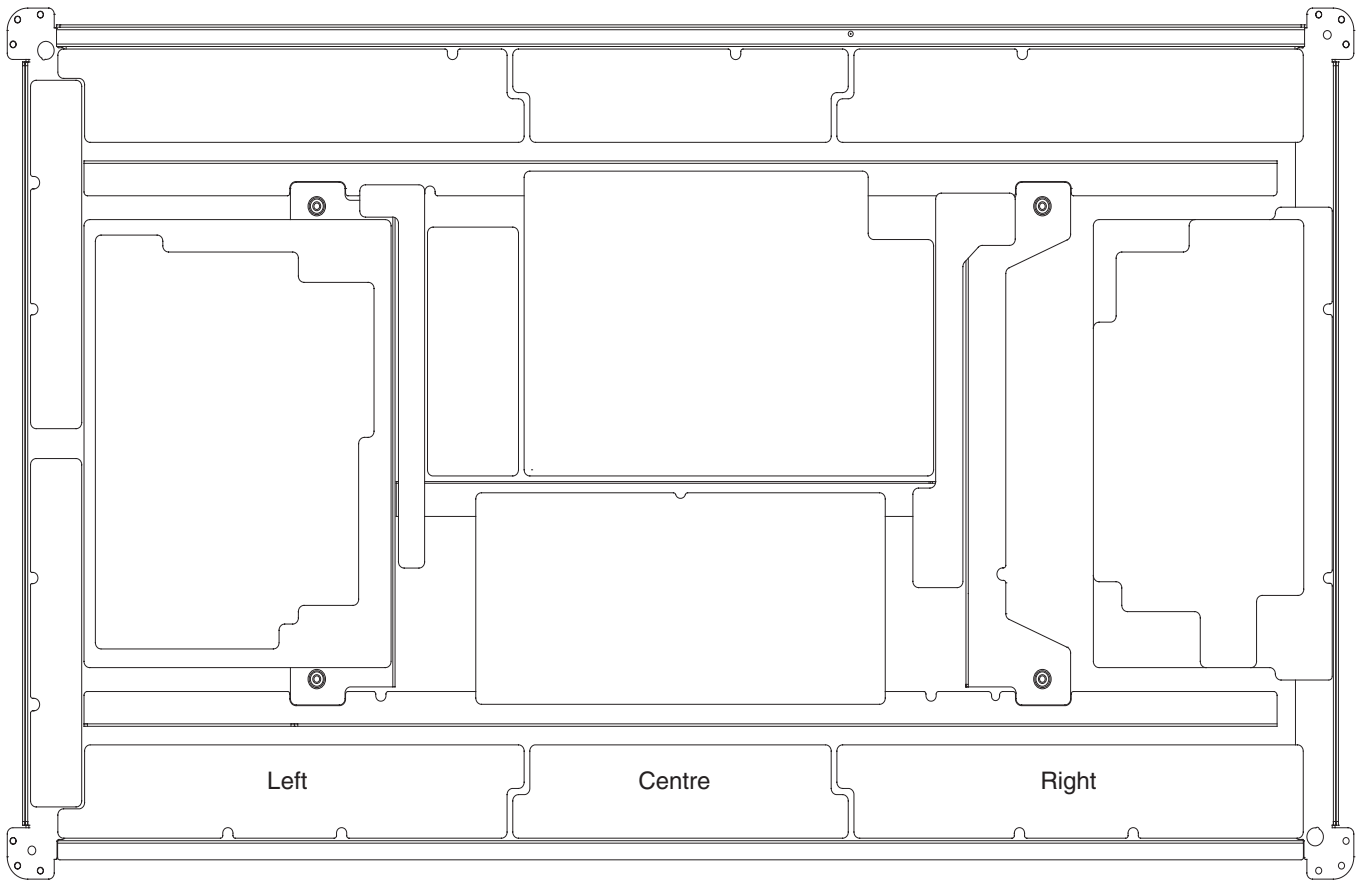
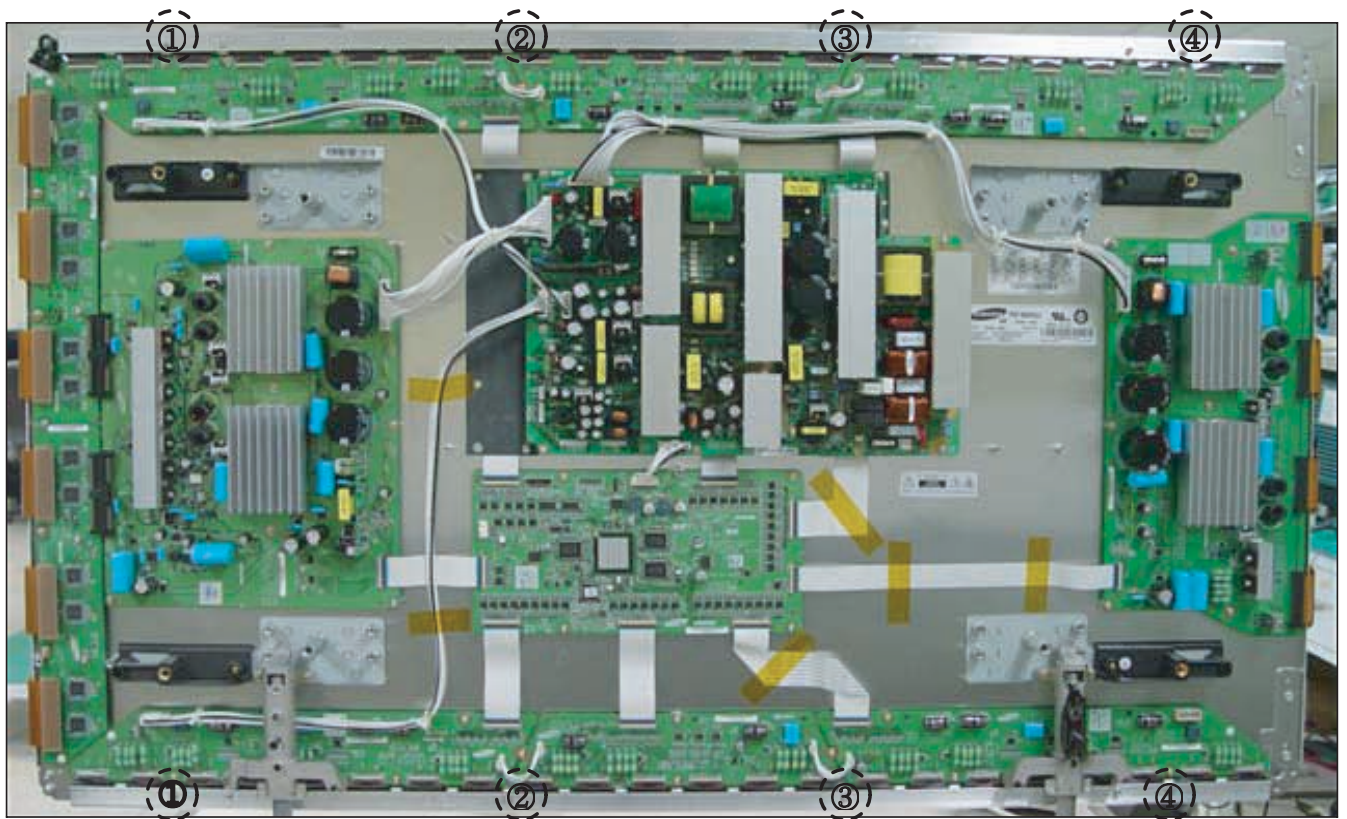

Figure 4-15 Photo 2 - 50" HD v3



F\_14001\_029.eps  
030805

Figure 4-16 Photo 2 - 50" HD v4

#### 4.1.5 Exchange YBU, YBL and YM board

1. Separate all the FPC connectors of YBU (Y-Buffer upper) and YBL (Y-Buffer lower). See "Photo 1".
  2. Separate all the connector of CN5001 and CN5008 from Y-Main. See "Photo 2".
  3. Loosen all the screws of YBU, YBL, and YM. See "Photo 3".
  4. Remove the board from chassis.
  5. Remove the connector of CN5006 and CN5007 among YBU, YBL and YM.
  6. Remove the YBL and YBU from Y-main.
  7. Remove the defected board.
- Note:** When replacing the Logic board or Y-main board for a lead-free (Pb-free) board, always replace them together. (this is **only** valid for the 37" SD v4 displays!)
8. Re-assemble the YBU and YBL to the Y-Main.
  9. Connect the connector of CN5006 and CN5007 among YBU, YBL and YM. See "Photo 4".
  10. Arrange the board on the chassis and then screw to fix.
  11. Connect the FPC and YM of panel to the connector. See "Photo 5".
  12. Supply the electric power to the module and then check the waveform of the board.
  13. Turn "off" the power after the waveform is adjusted.

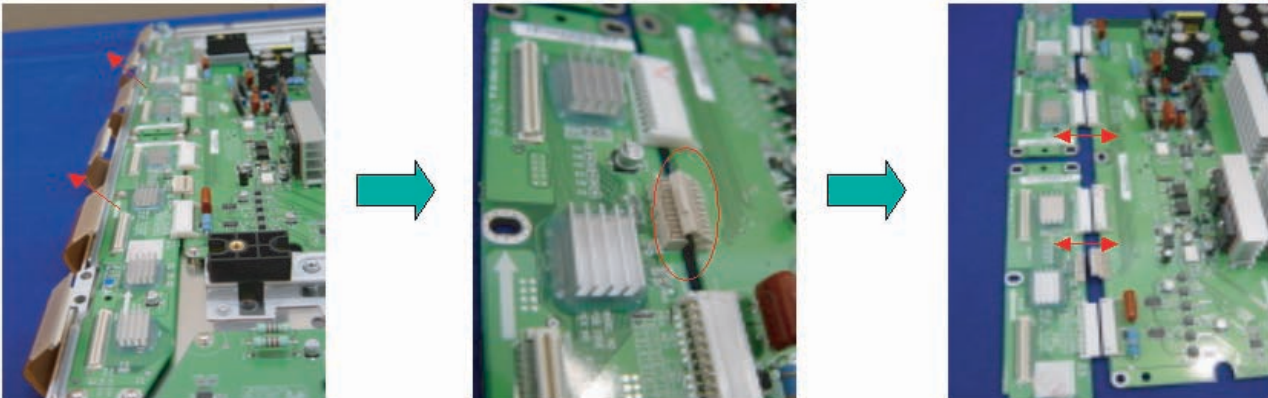

Figure 4-17 Photo 1, 2, and 3: Dis-assembly of YBU, YBL, and YM

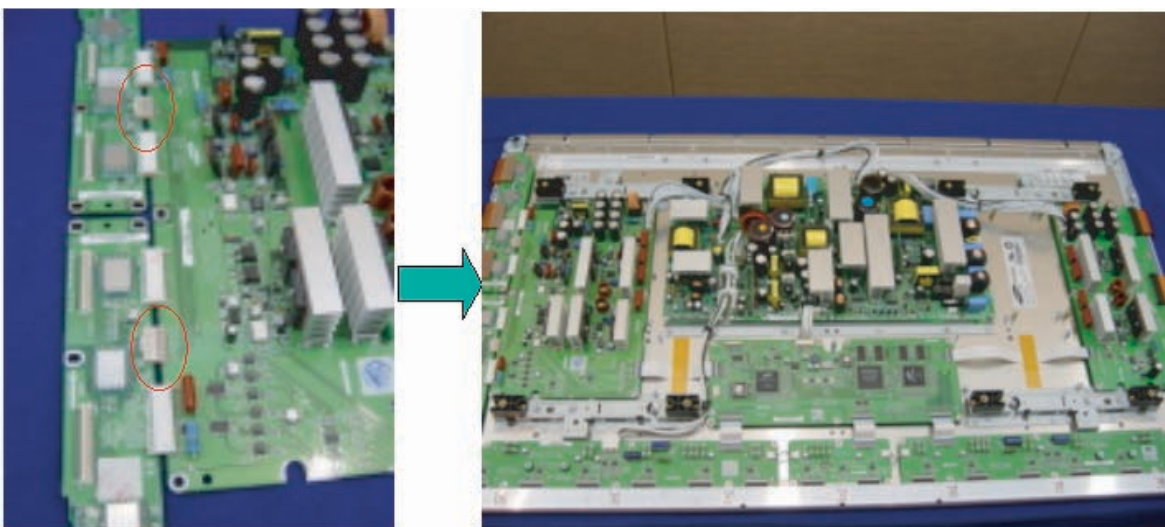

Figure 4-18 Photo 4 and 5: Re-assembly of YBU, YBL, and YM



# 5. Service Modes, Error Codes, and Fault Finding

**Index of this chapter:**

- 5.1 Repair Tools
- 5.2 Fault Finding
- 5.3 Defect Description Form

## 5.1 Repair Tools

### 5.1.1 ComPair

For the v3 and v4 models, it will be possible to generate test patterns with ComPair. The ComPair interface must be connected to the Logic Board with the special interconnection cable (see table below for the order code).

### 5.1.2 Other Service Tools

**Table 5-1 Overview Service tools**

Service Tools	Order Code
Jumper J8002 + V2 JIG connector kit	3122 785 90760
V3 JIG connector + for SDI panel repair	3122 785 90770
Jumper J8002 to be used in connector kit	3122 785 90780
V2 JIG connector to be used in conn. kit	3122 785 90790
ComPair / SDI interconnection cable	3122 785 90800
Foam buffers (2 pcs.)	3122 785 90581



F\_14991\_030.eps  
030805

**Figure 5-3 V3 jig**

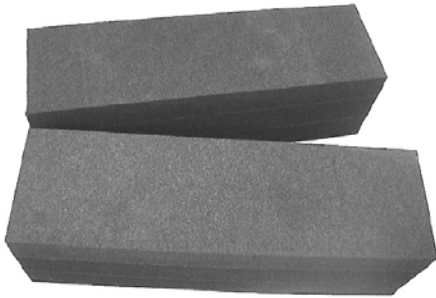

**Figure 5-1 Foam buffers**



F\_14991\_031.eps  
030805

**Figure 5-2 V2 jig**

5.2 Fault Finding

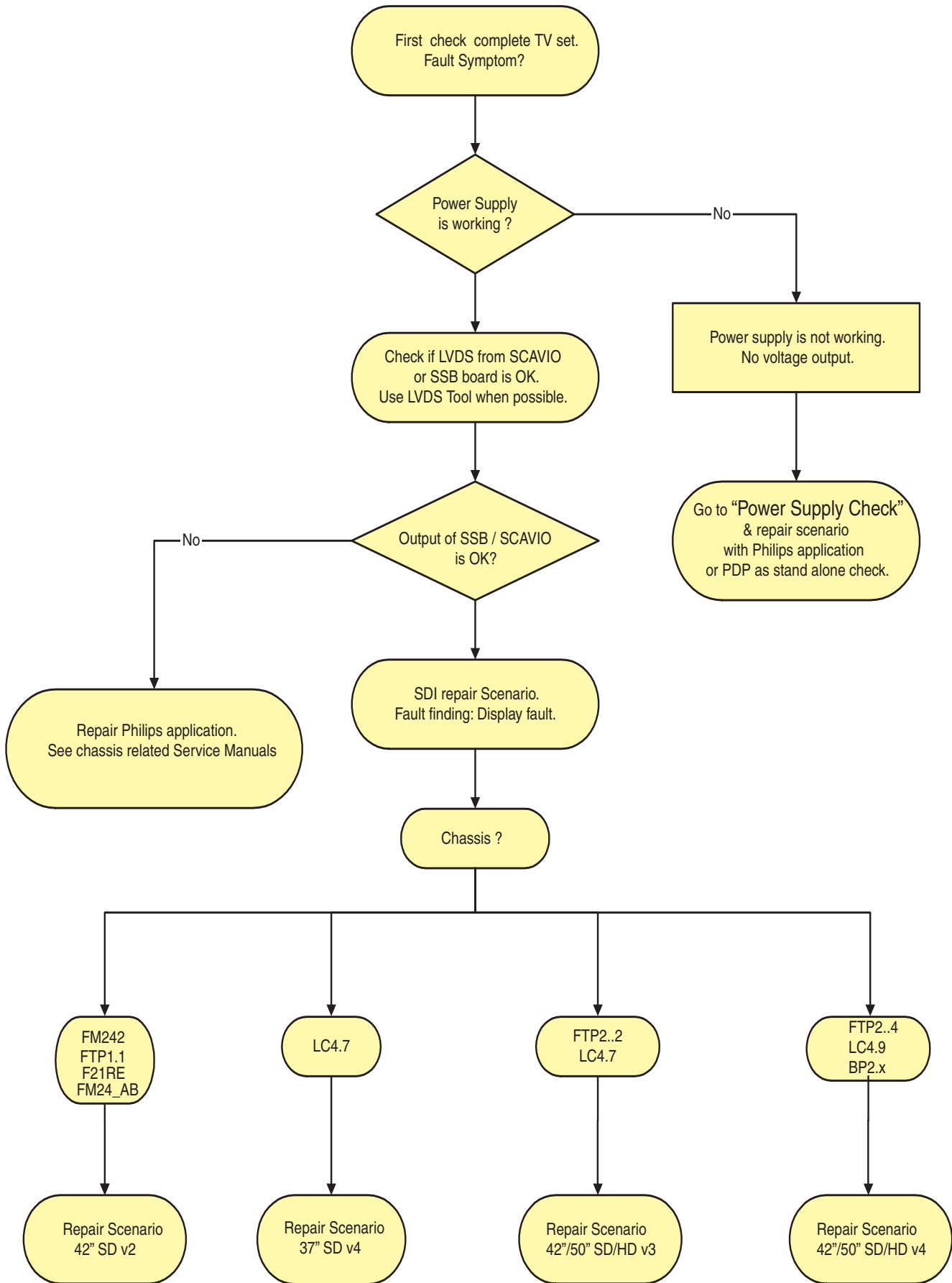

Figure 5-4 Which repair scenario?

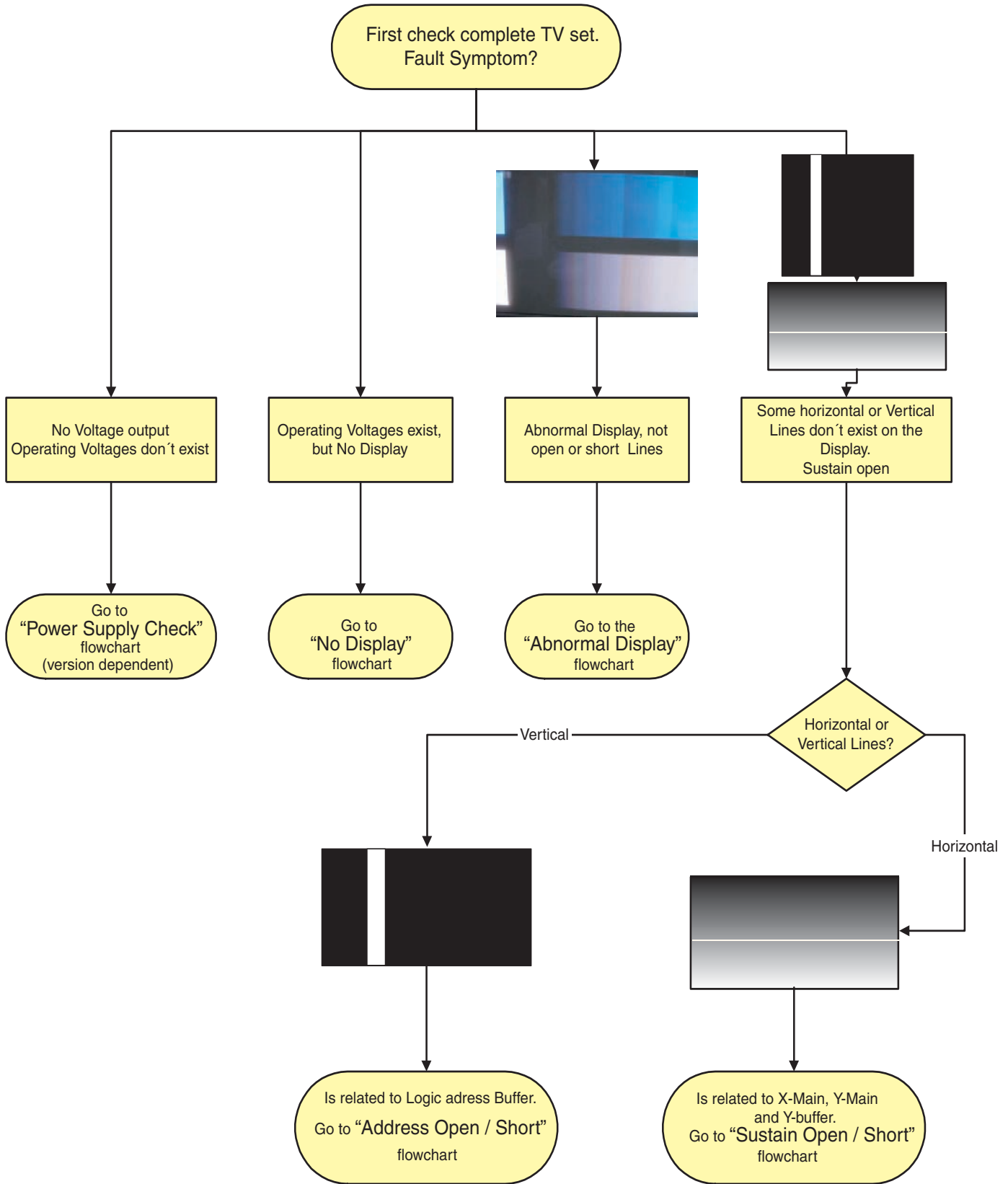

Figure 5-5 Fault symptom overview (complete TV set)

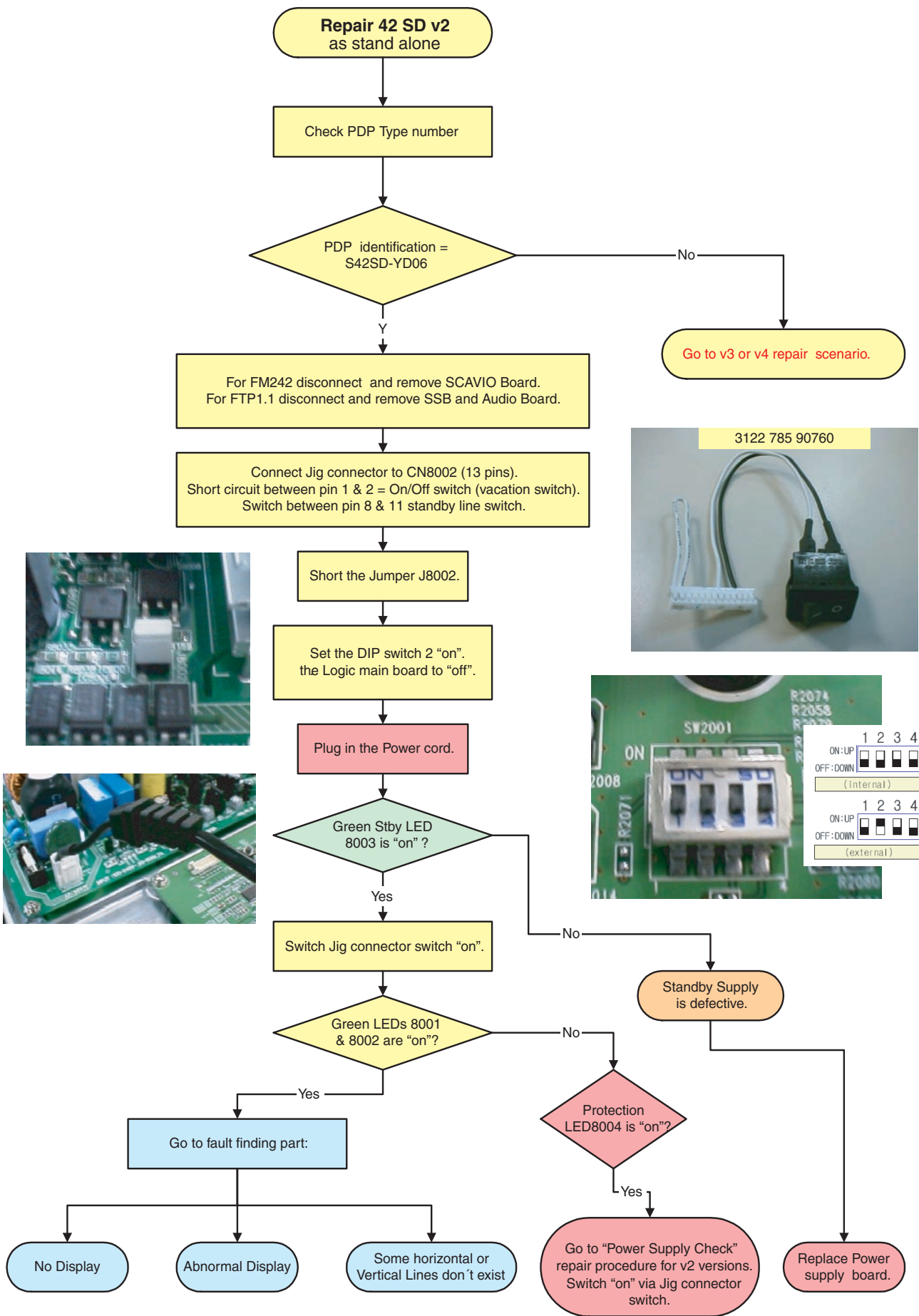

Figure 5-6 Repair scenario v2 stand alone panels

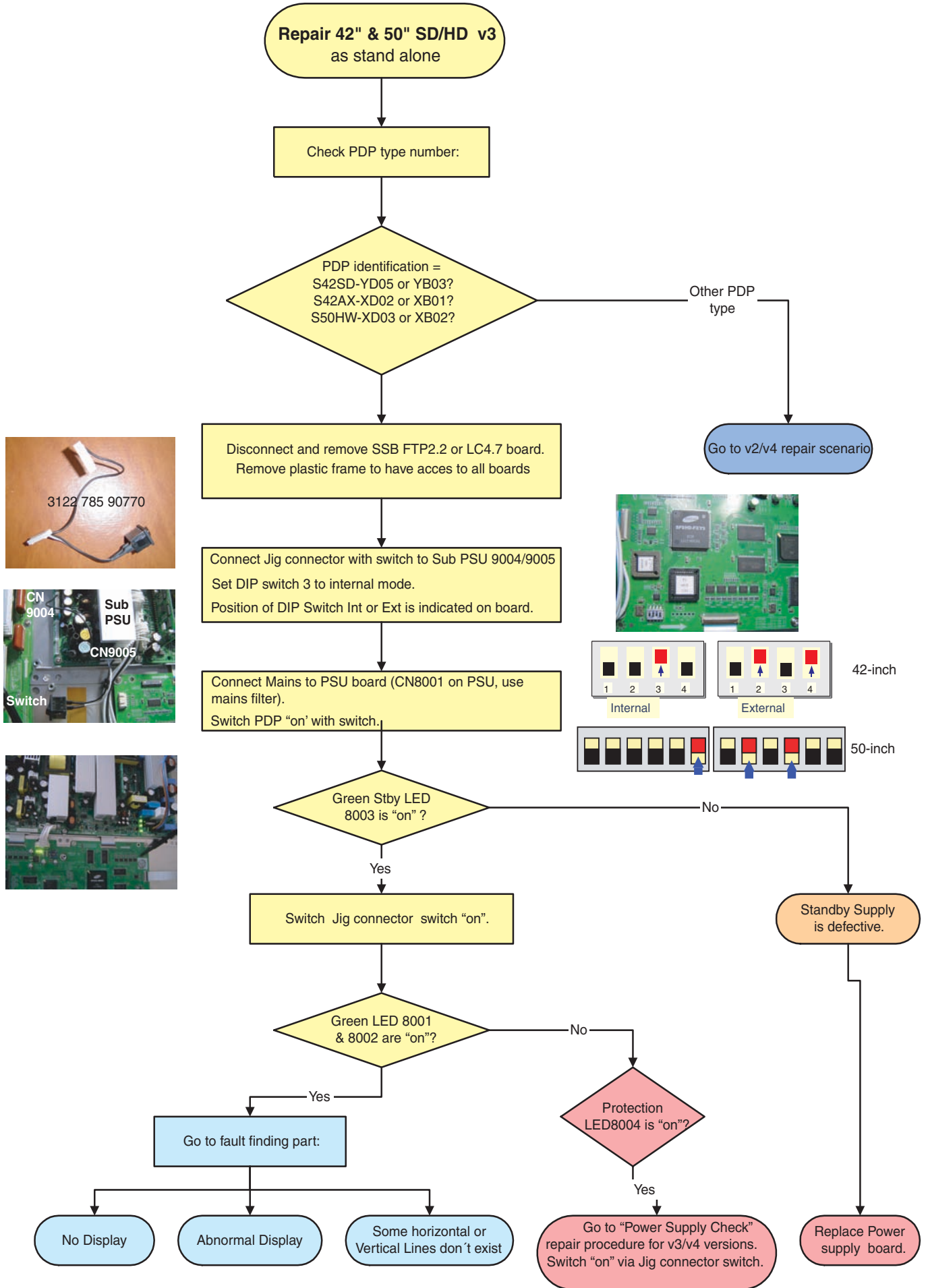

Figure 5-7 Repair scenario 42"/50" SD/HD v3 stand alone panels

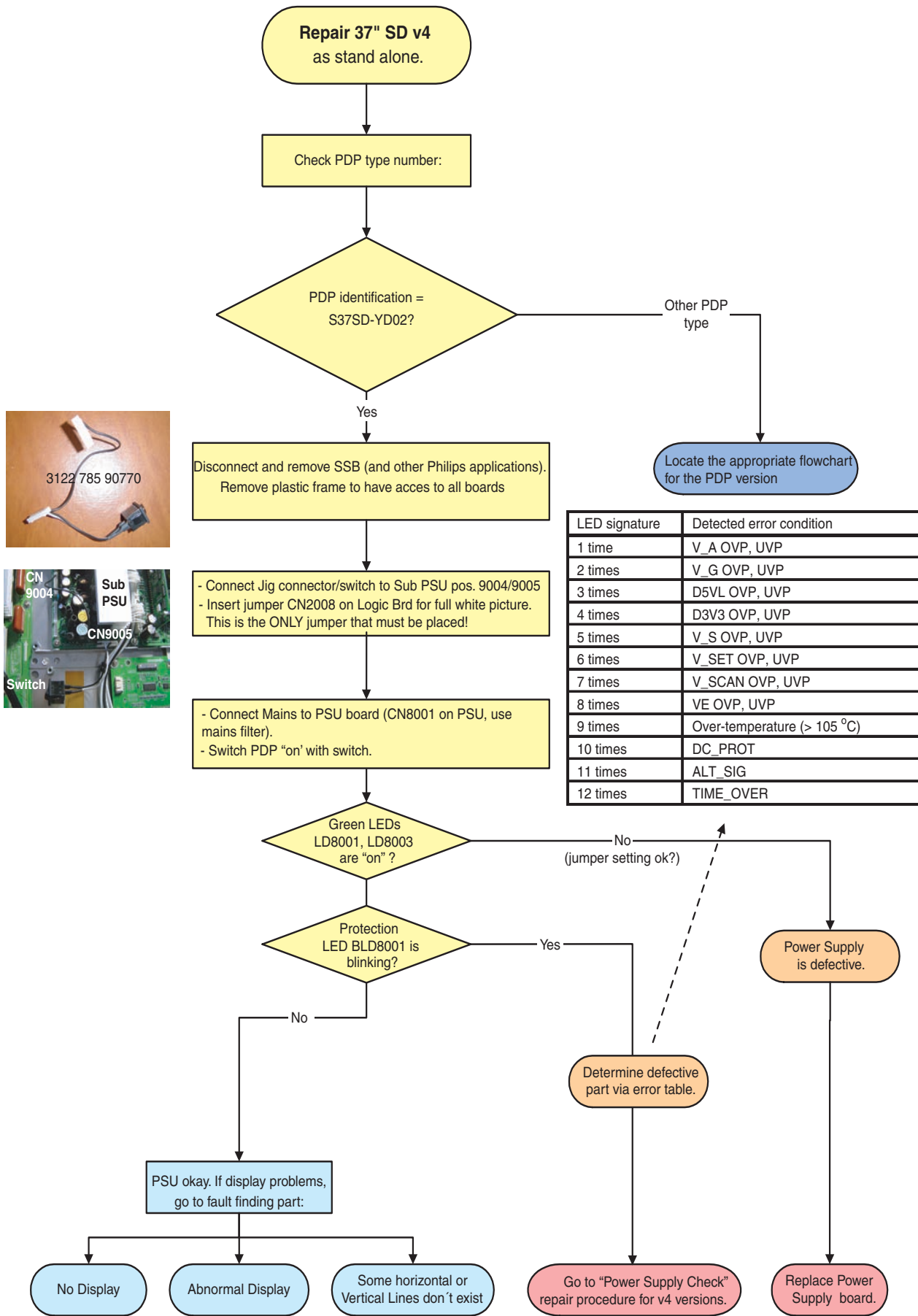

Figure 5-8 Repair scenario 37" SD v4 stand alone panels

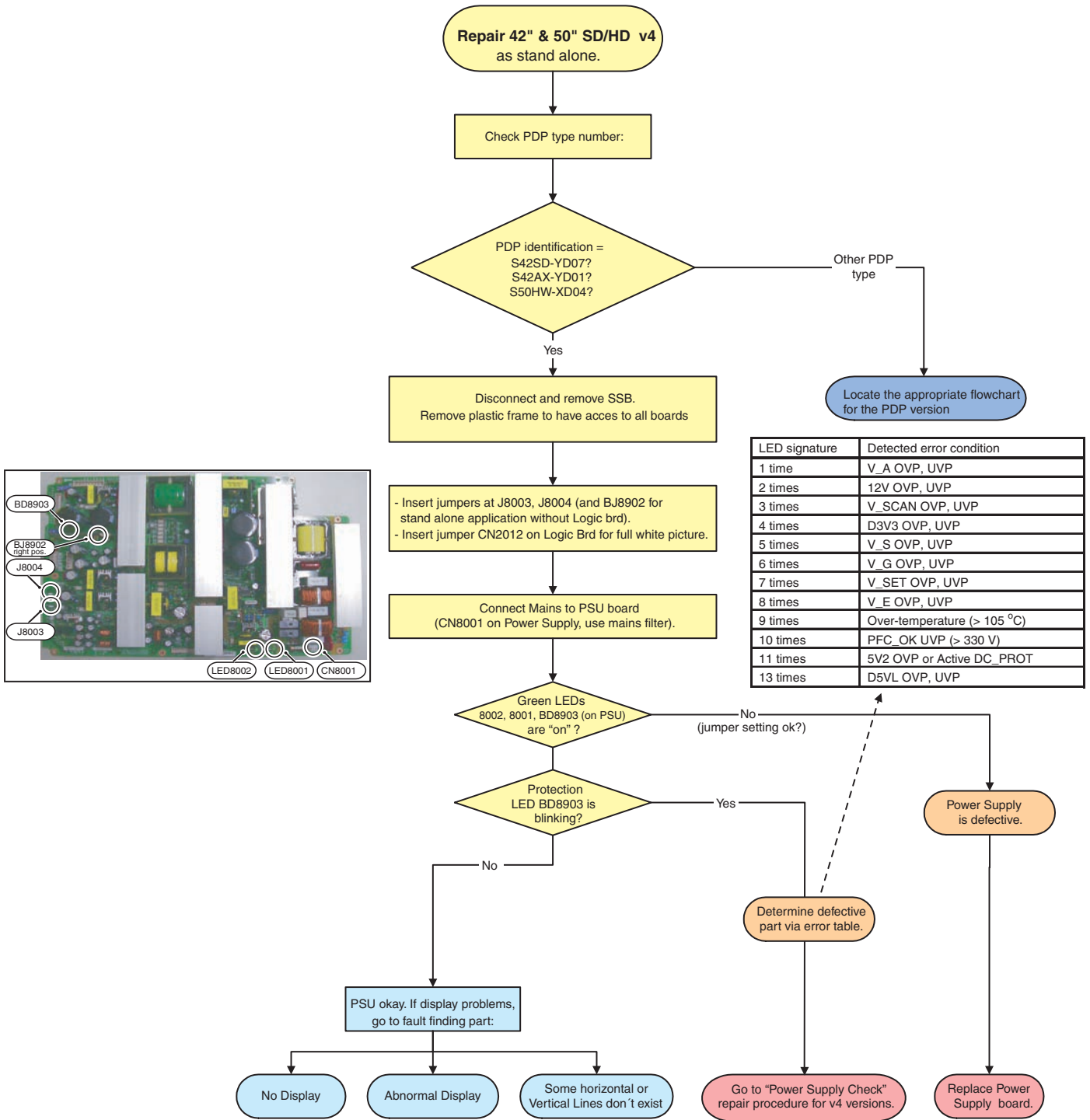

Figure 5-9 Repair scenario 42"/50" SD/HD v4 stand alone panels

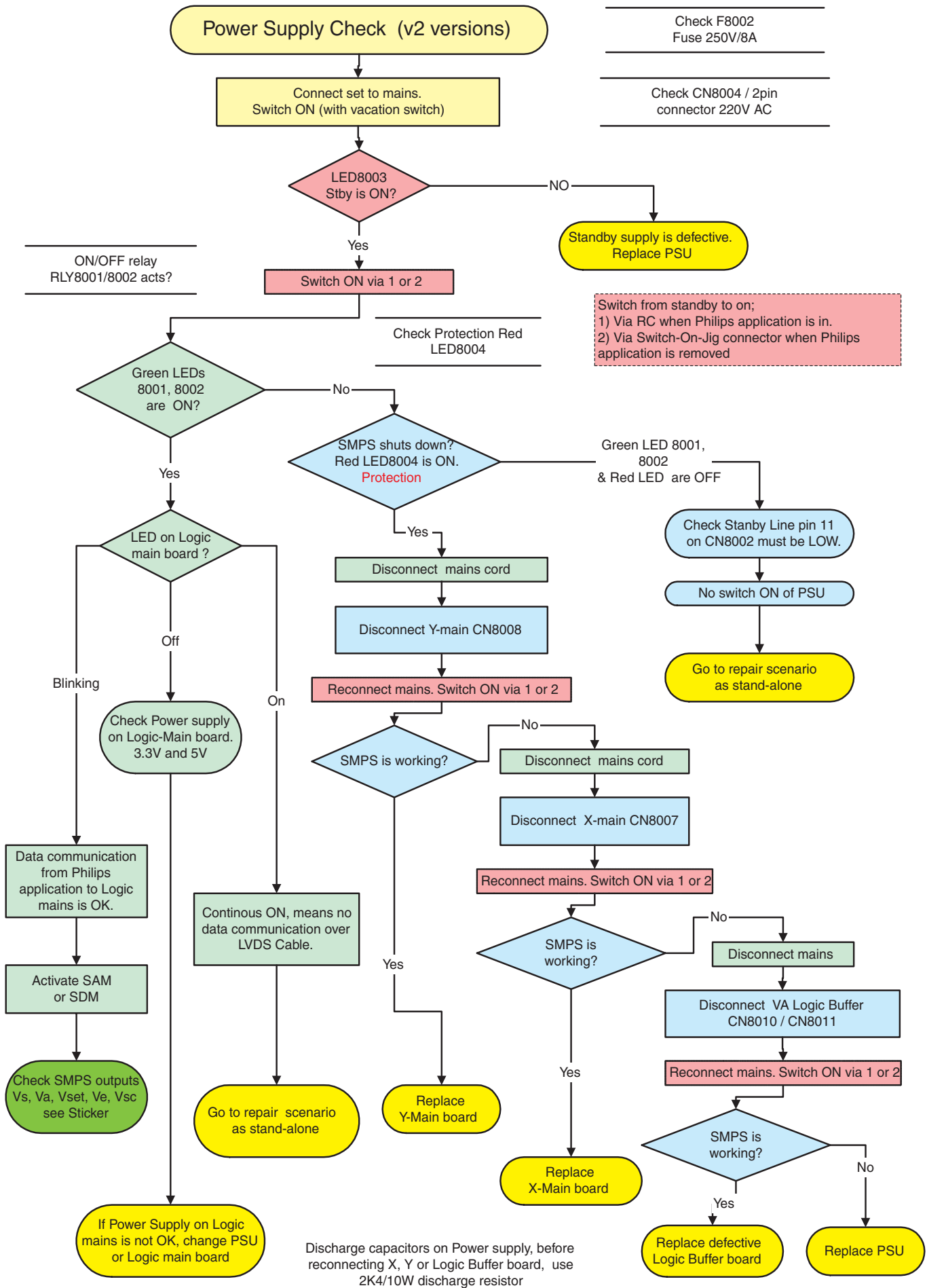

Figure 5-10 Power Supply Check for v2 models



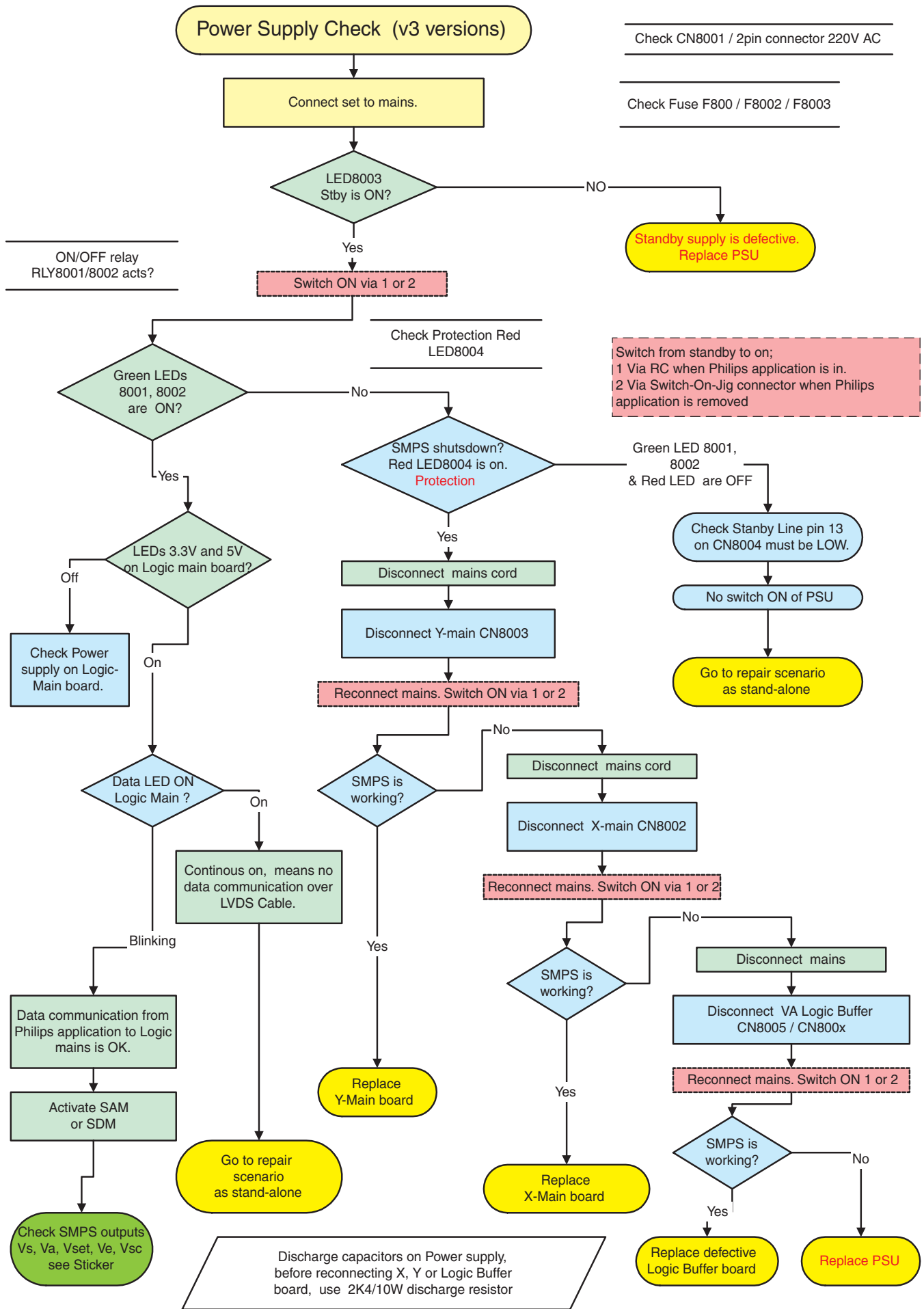

Figure 5-11 Power Supply Check for v3 models

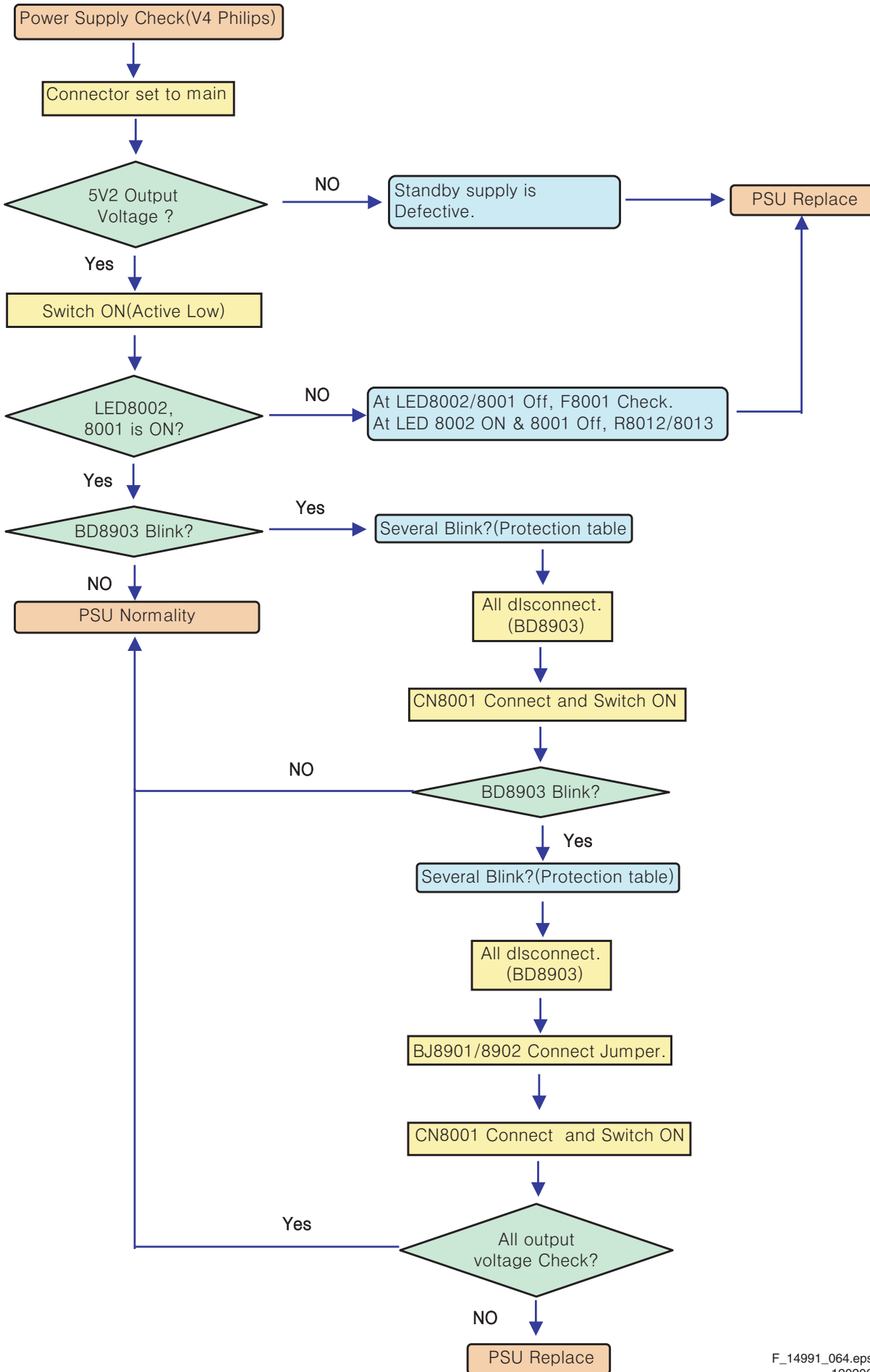

Figure 5-12 Power Supply Check for v4 models

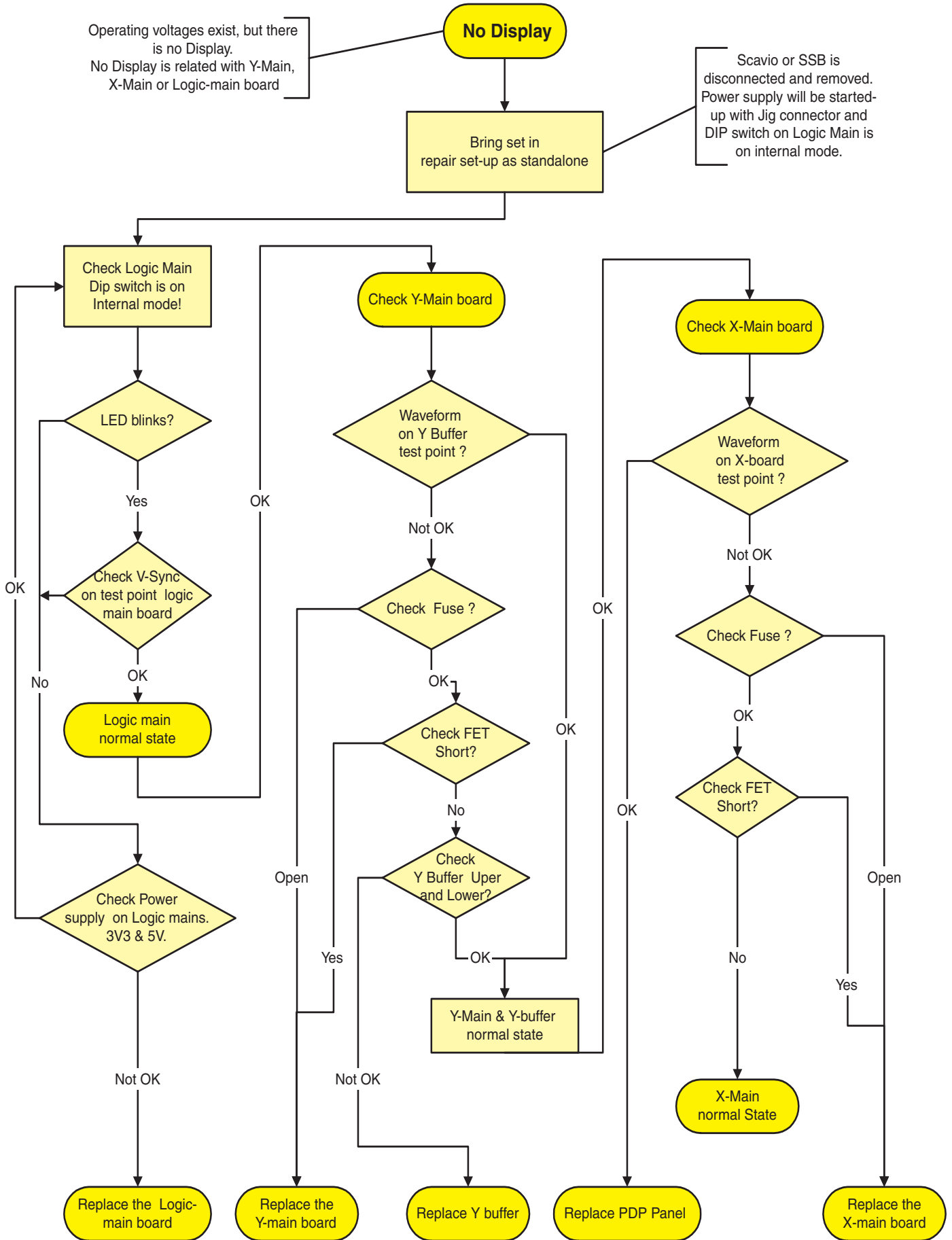

Figure 5-13 Fault symptom: "No Display"

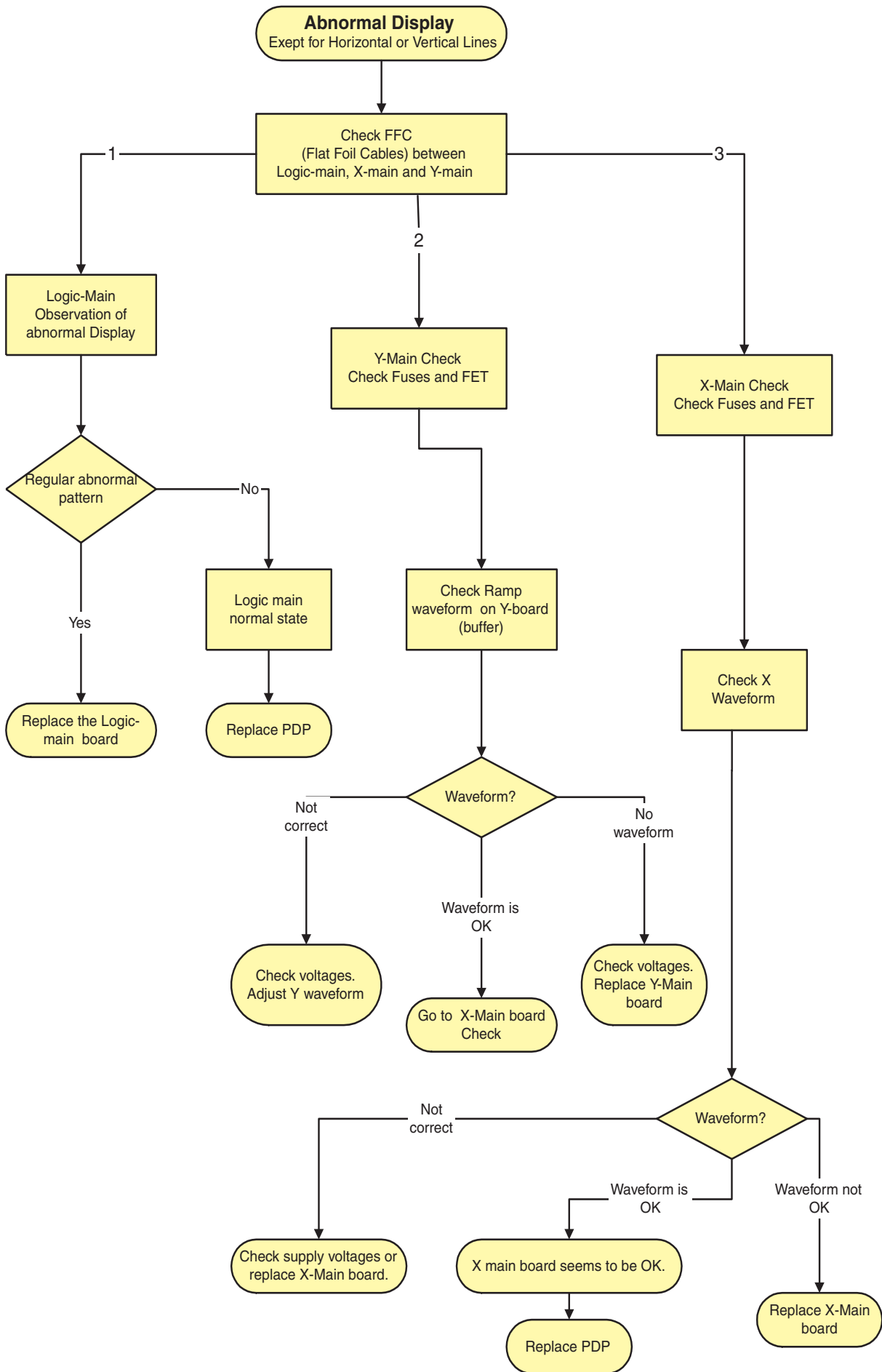

Figure 5-14 Fault symptom: "Abnormal Display"

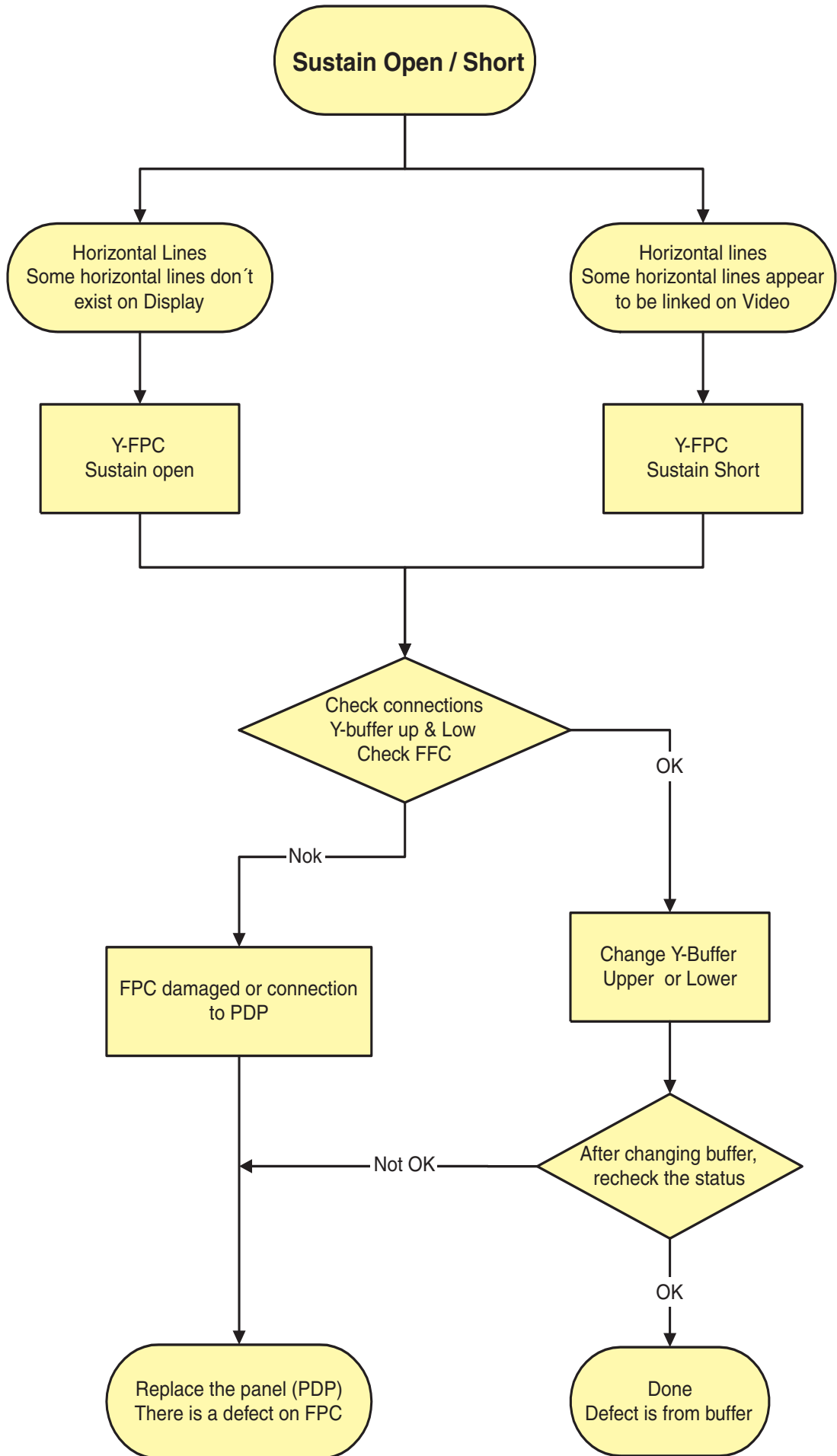

Figure 5-15 Fault symptom: "Sustain open / short"

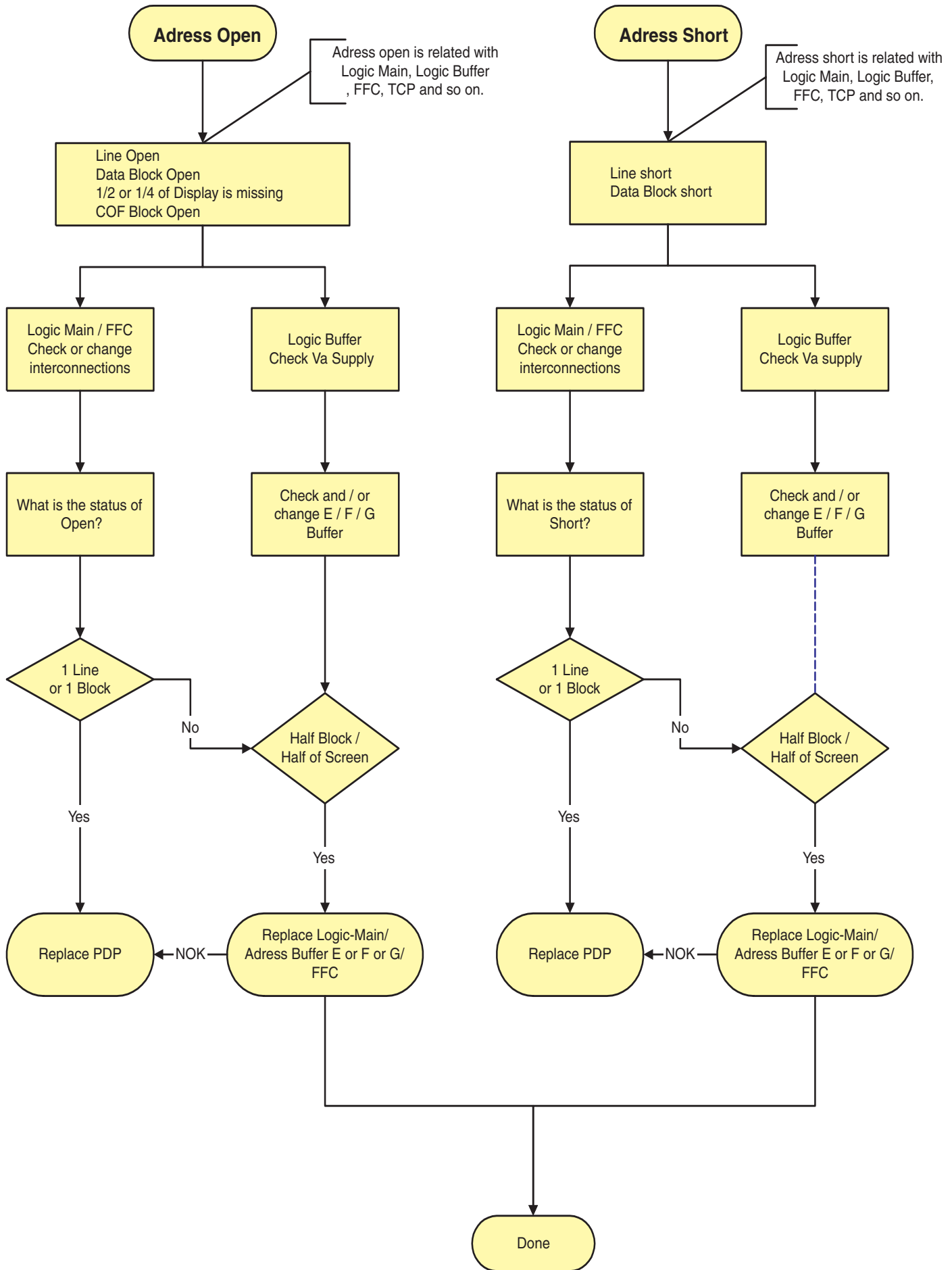

Figure 5-16 Fault symptom: "Address open / short"

5.3 Defect Description Form

This form must be used by the workshops for warranty claims:

DDF FLAT TV (panels & boards) version 1.1				Date last modified: 08/03/2005	
To be filled in by <u>WORKSHOP / WORK CENTER</u>					
Country:	<b>Philips</b>		Type nr./Model nr. set		
Customer Account nr.:	LCD & Plasma		Serial nr. set		
Job sheet nr.:	<b>DEFECT DESCRIPTION</b>		Type nr. display		
	<b>FORM</b>		Serial nr. display		
			Part nr display (12nc)		
			Return number	0170 _ _ _ _ _	
GENERAL REPAIR DATA	Condition	<input type="checkbox"/> Constantly <input type="checkbox"/> Intermittently <input type="checkbox"/> After a while		<input type="checkbox"/> In a hot environment <input type="checkbox"/> In a cold environment <input type="checkbox"/> Other : .....	
	Symptom(s)	<input type="checkbox"/> No backlight <input type="checkbox"/> No picture <input type="checkbox"/> Picture too bright <input type="checkbox"/> Shading / smearing on picture <input type="checkbox"/> Only partial picture <input type="checkbox"/> Unstabel picture			
PANEL REPAIR	Pixel Defect(s):	<input type="checkbox"/> Dark dots <input type="checkbox"/> Bright dots	Qty of dots : ..... .....	Mark Defect(s)	----- Picture -----  Insert picture or mark defect !
	Symptoms	Following defect symptoms are out of warranty: • Broken glass • Scratch(es) on display			These symptoms are not claimable.
<u>Out of warranty</u>	• Number of dark/bright pixels within spec. • Burn in (only for Plasma TV)				
BOARD REPAIR	<u>For Plasma TV repair only</u>	Spare Part Nr. New Board	Barcode Nr. Defect Board	Barcode Nr. Replaced Board	
	1.				
	2.				
	3.				
	4.				
To be filled in by <u>EUROSERVICE</u>		RMA number:	Date of receipt:		
Note 1: The defective LCD-panel / PDP needs to be returned in the same packaging as the new part was send. If not the warranty claim will be rejected. Note 2: Please fill out this form <u>completely</u> and correctly, otherwise Euroservice is unable to fulfil the repair request!					
Owner: PHILIPS CE EUROSERVICE				DE10WEG	

Figure 5-17 Defect Description Form (DDF)

# 6. Block Diagrams, Test Point Overview, and Waveforms

**Index of this chapter:**

- 6.1 Block Diagram for Logic Circuit
- 6.2 PSU Board diagram

## 6.1 Block Diagram for Logic Circuit

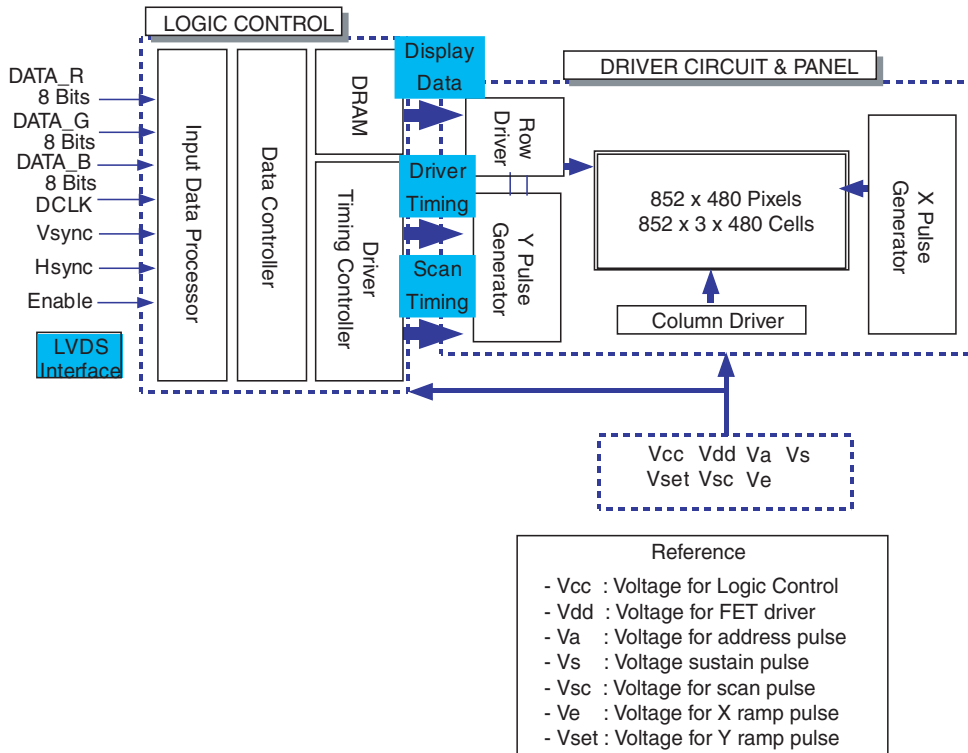

Figure 6-1 Block diagram (37" SD v4)

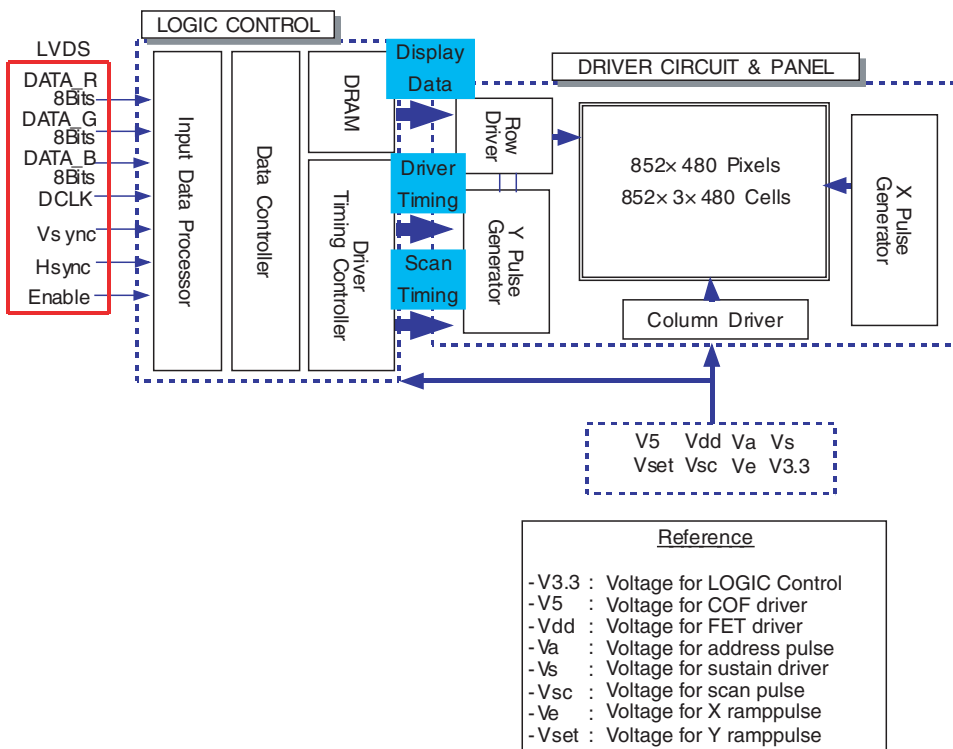
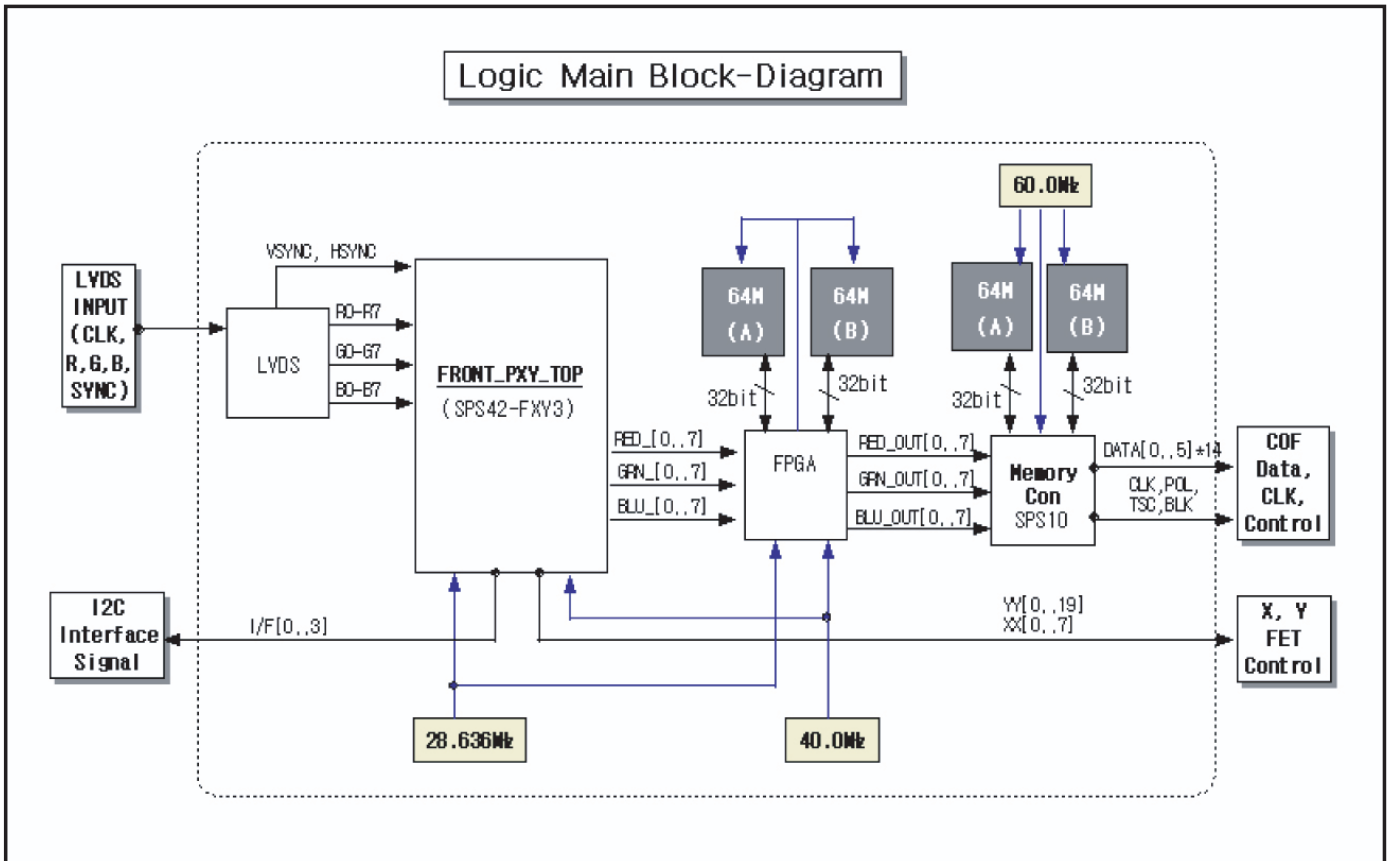

Figure 6-2 Block diagram (42" SD v2)





F\_14991\_032.eps  
030805

Figure 6-3 Block diagram (42" SD v3)

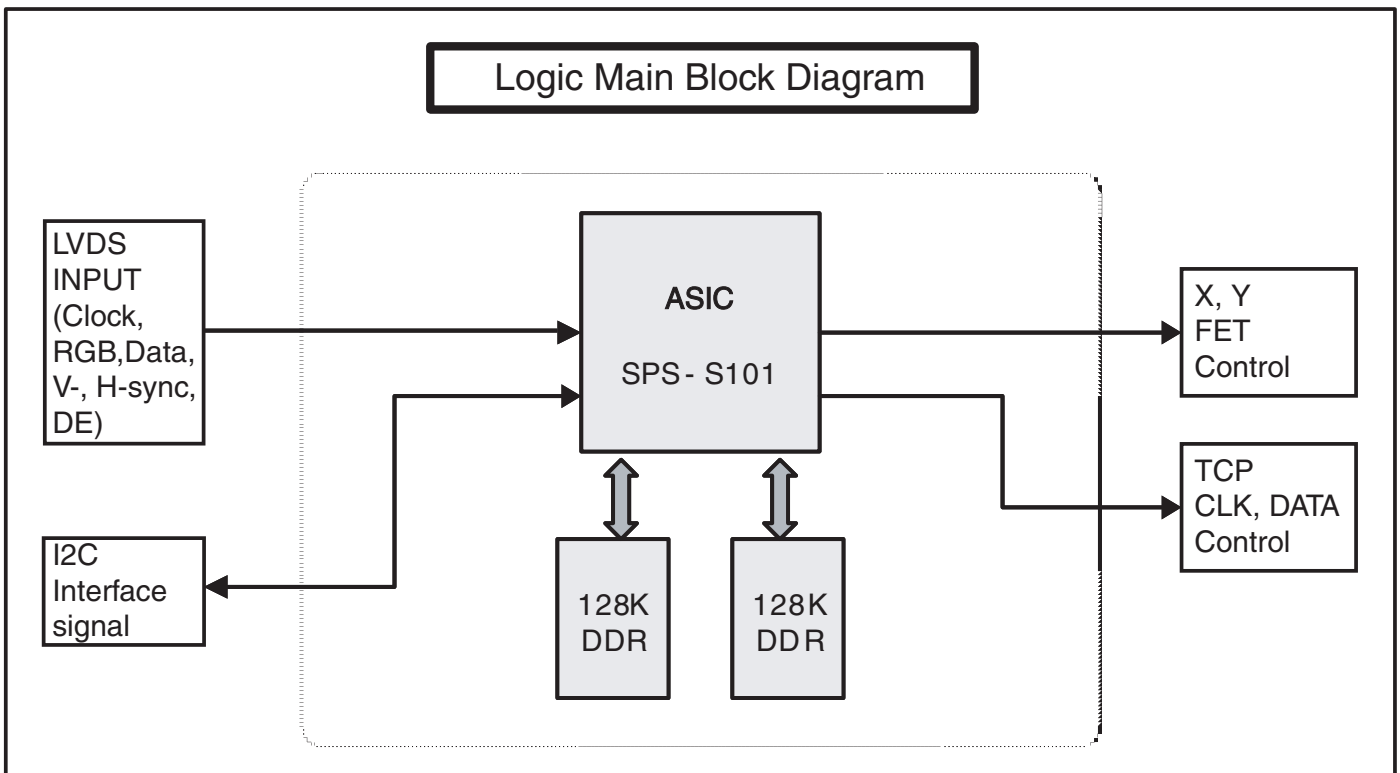

F\_14991\_002.eps  
180705

Figure 6-4 Block diagram (42" SD v4)

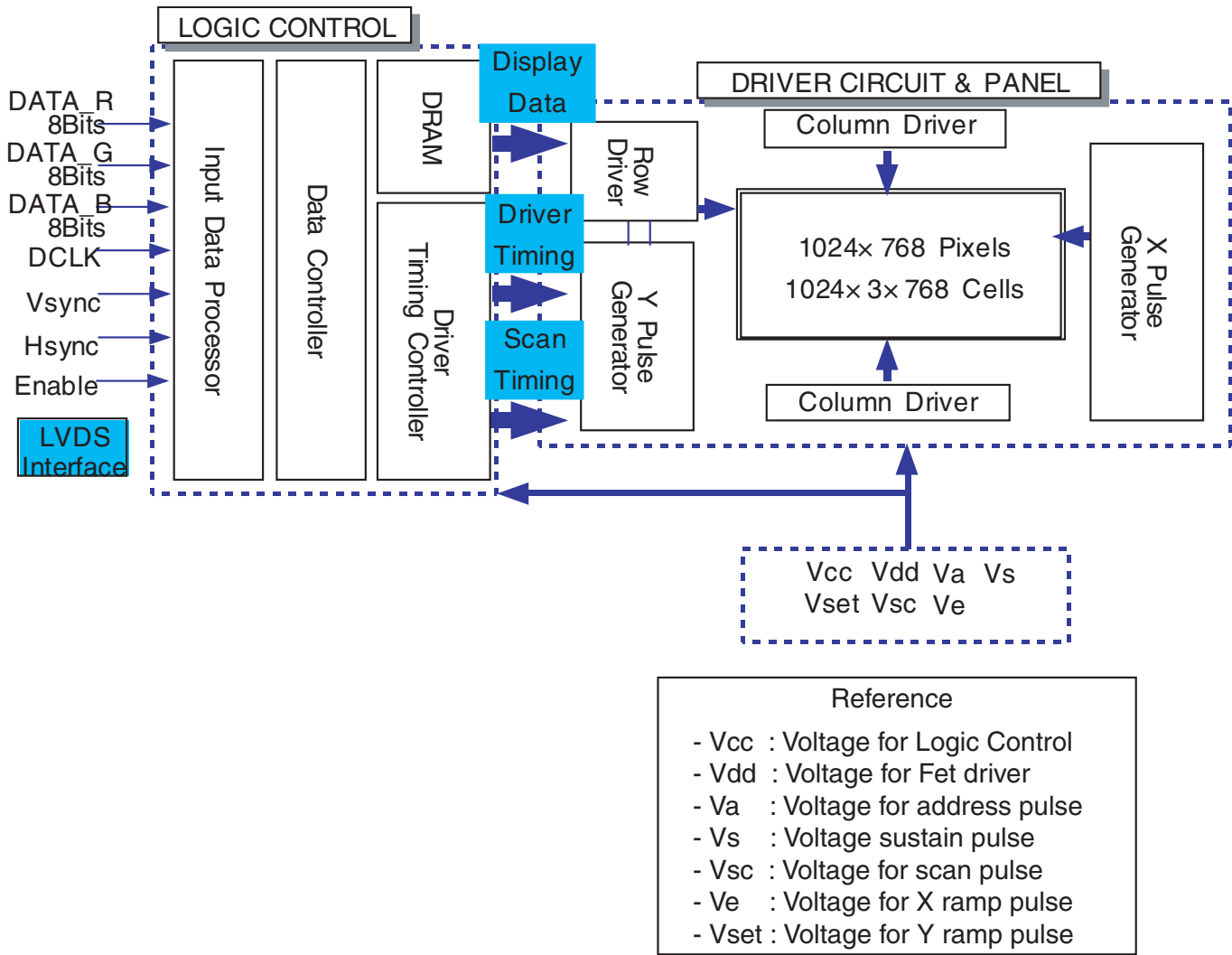

Figure 6-5 Block diagram (42" HD v3)

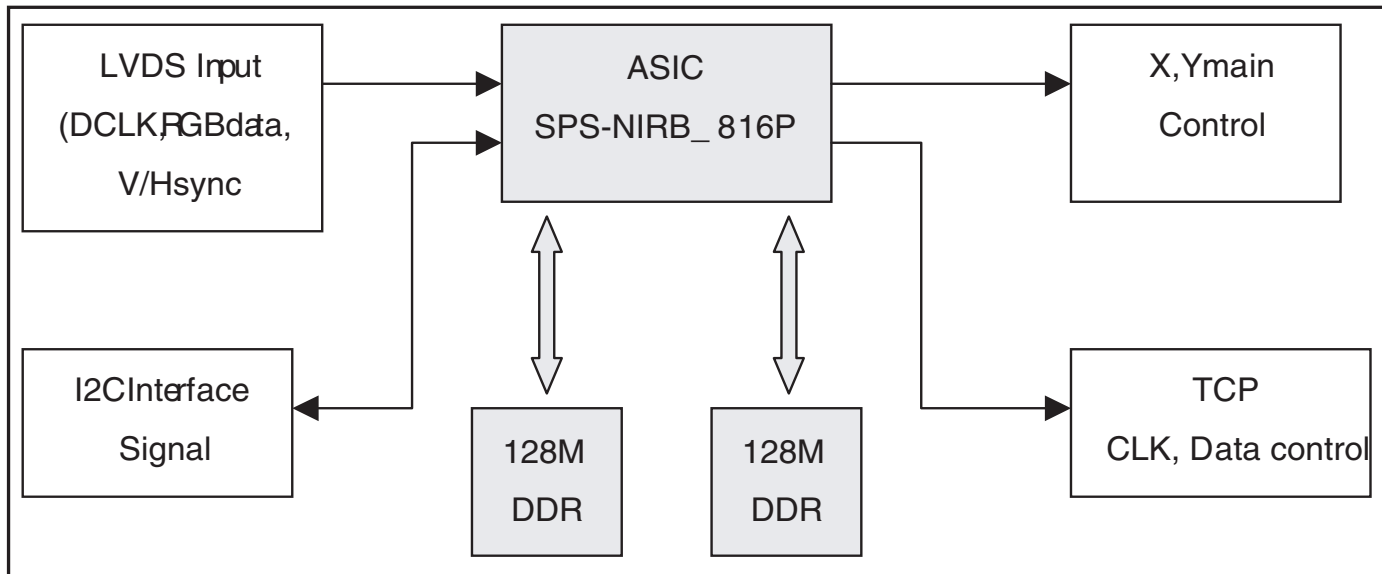

Figure 6-6 Block diagram (42" HD v4)

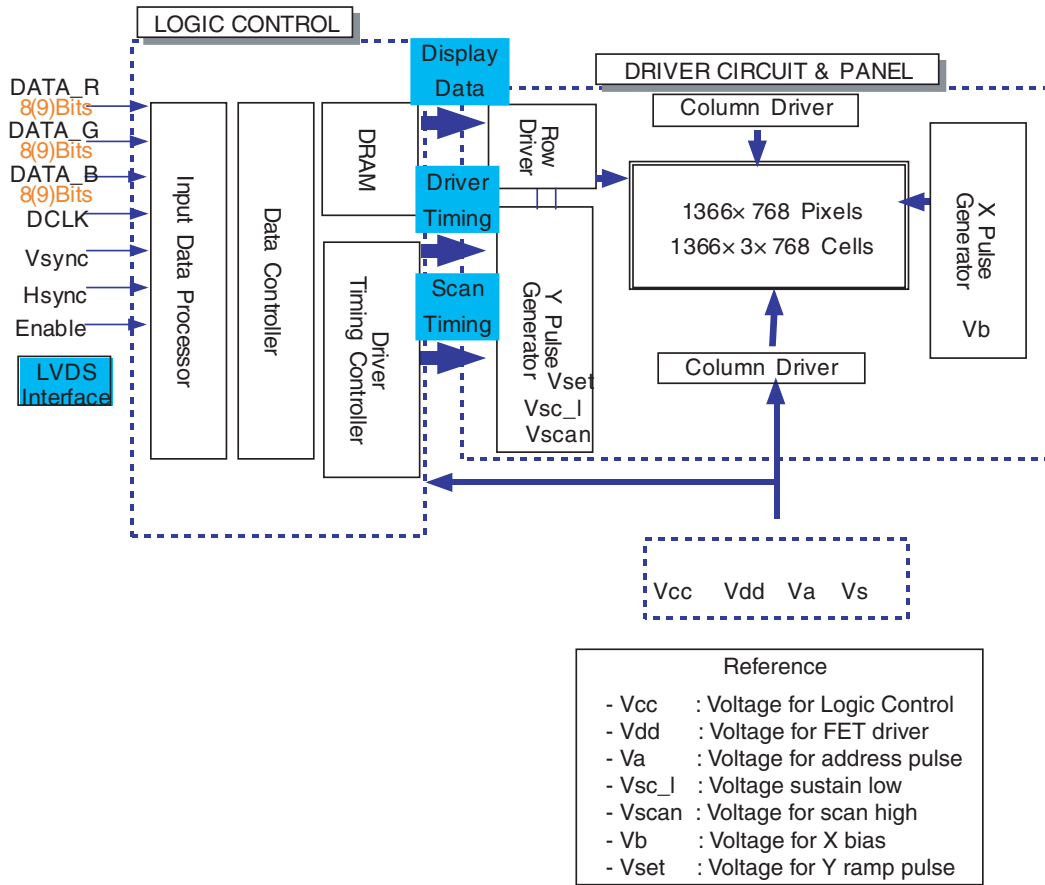

Figure 6-7 Block diagram (50" HD v3)

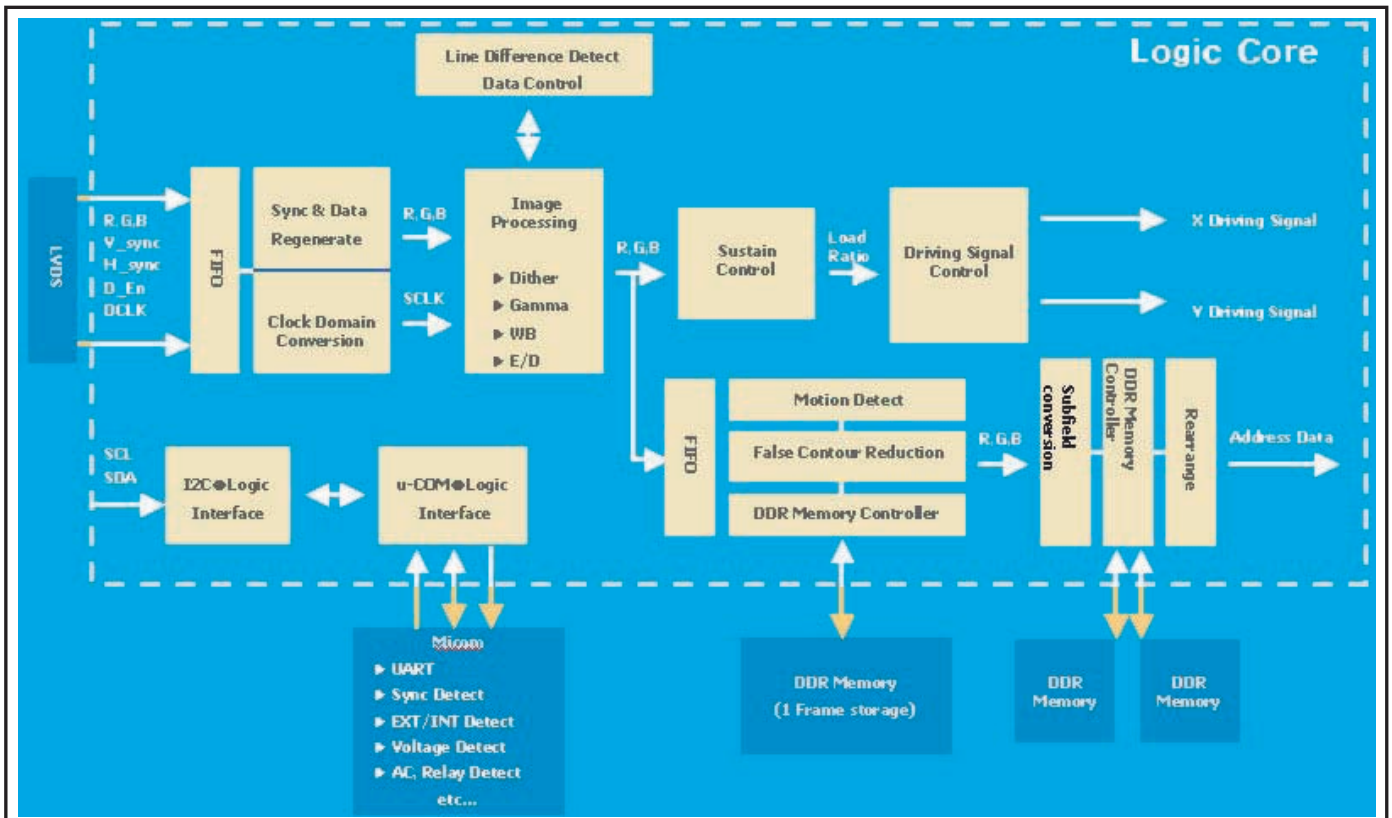

Figure 6-8 Block diagram (50" HD v4)



6.2.2 PSU 42" SD v2

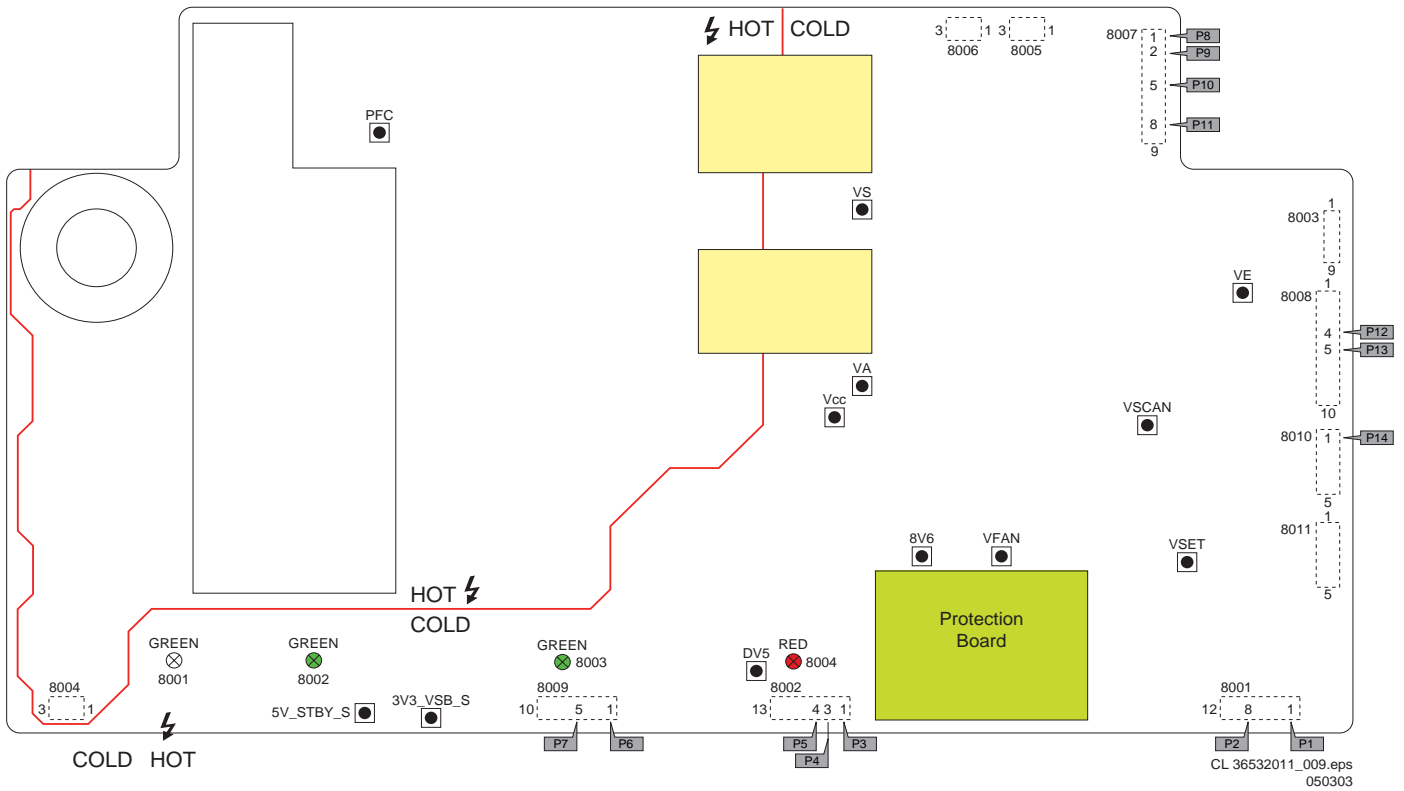

Figure 6-10 PSU layout

Table 6-2 Adjustment voltage level overview

No	Output voltage (V)	Voltage Setting (Nominal Load)	Output Voltage Variable Point
1	Vs	87V	78V ~ 92V
2	Va	79V	72V ~ 86V
3	Ve	107V	100V ~ 120V
4	Vset	93V	75V ~ 95V
5	Vscan	79V	65V ~ 85V
6	Vg	15V	Fixed
7	D5V	5.2V	5V ~ 5.6V
8	D3V3	3.3V	2.8V ~ 3.7V
Check voltage label on the PDP for correct values.			

6.2.3 PSU 42" SD v3

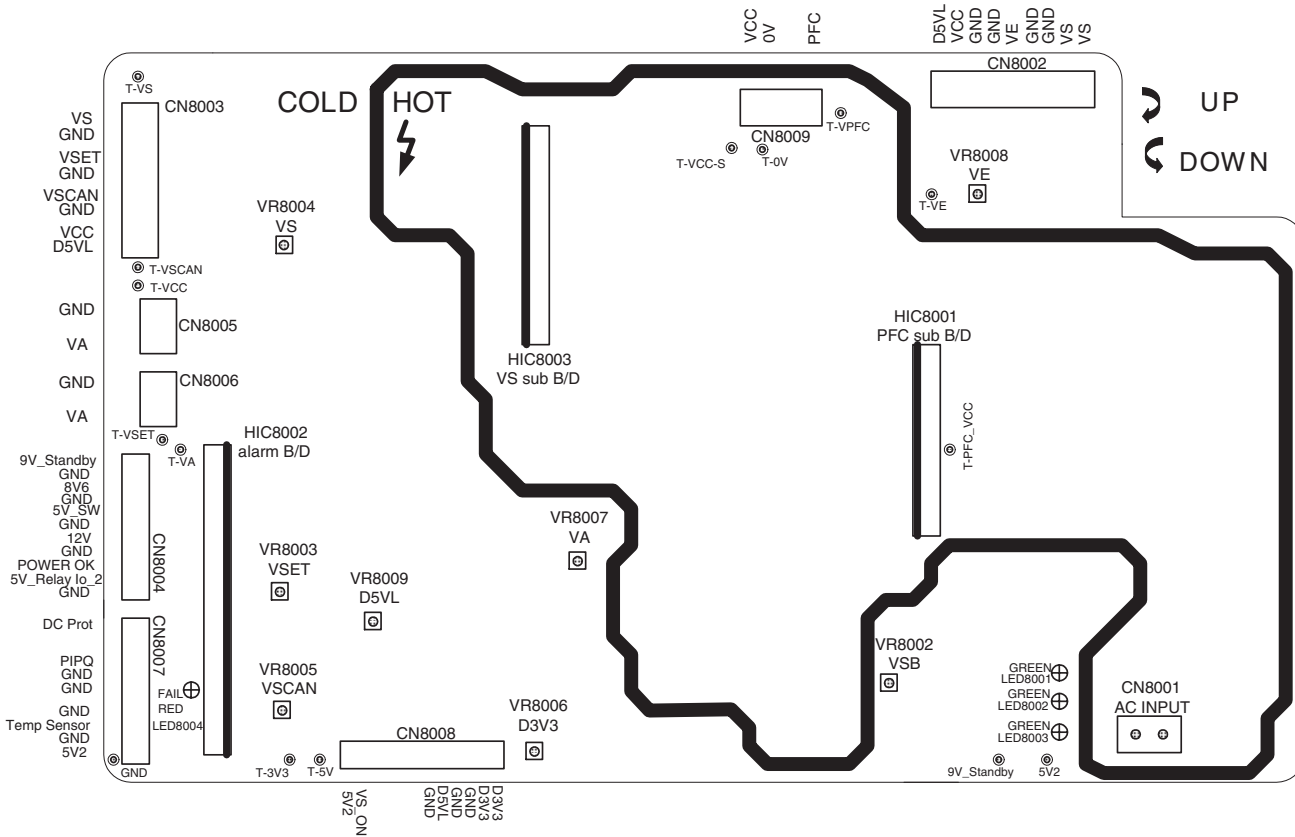

Figure 6-11 PSU layout

Table 6-3 Adjustment voltage level overview

No	Output voltage (V)	Voltage Setting (Nominal Load)	Output Voltage Variable Point
1	Vs	175V	160V ~ 185V
2	Va	70V	65V ~ 80V
3	Ve	160V	150V ~ 170V
4	Vset	173V	160V ~ 18095V
5	Vscan	-60V	-55V ~ -75V
6	D5VL	5.2V	4.0V ~ 6V
7	D3V3	3.3V	5V ~ 5.6V
8	Vcc	15V	Fixed
Check voltage label on the PDP for correct values.			

6.2.4 PSU 42" SD v4

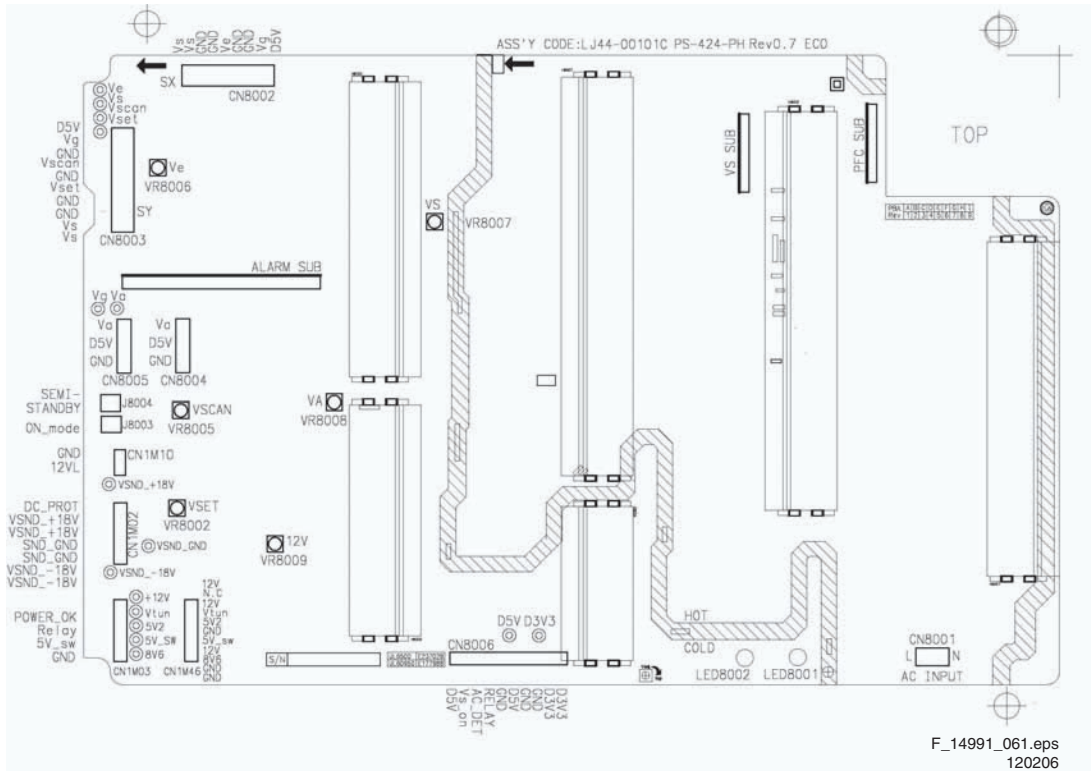

Figure 6-12 PSU layout

Table 6-4 Adjustment voltage level overview

No	Output voltage (V)	Voltage Setting (Normal Load)	Output Voltage Variable Point
1	VS	207V ± 1%	195V ~ 215V
2	VA	70V ± 1.5%	50V ~ 70V
3	VE	110V ± 1.5%	70V ~ 110V
4	VSET	198V ± 1.5%	180V ~ 210V
5	VSCAN	-185V ± 1.5%	-170V ~ -190V
6	VSB	5V ± 5%	Fixed
7	VG	15V ± 5%	Fixed
8	D5VL	5.2V ± 5%	Fixed
9	D3V3	3.3V ± 5%	Fixed

Check voltage label on the PDP for correct values.





6.2.6 PSU 42" HD v4

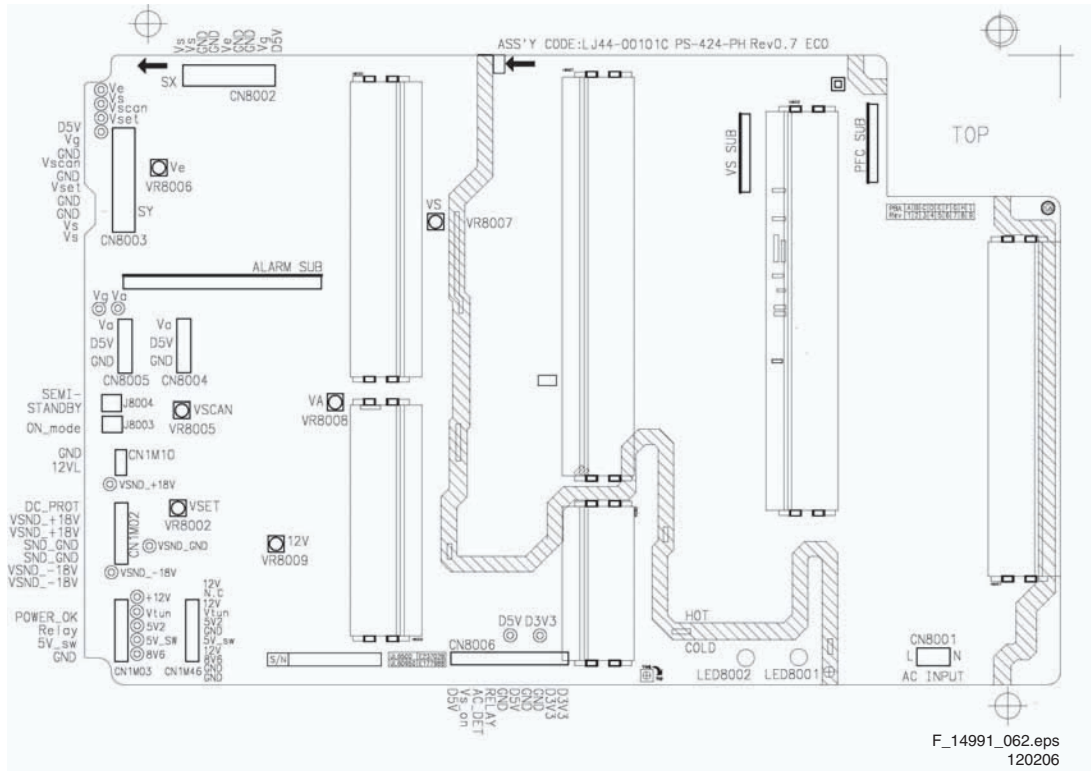

Figure 6-14 PSU layout

Table 6-6 Adjustment voltage level overview

No	Output voltage (V)	Voltage Setting (Normal Load)	Output Voltage Variable Point
1	Vs	208V	190V ~ 210V
2	Va	70V	50V ~ 70V
3	Ve	90V	80V ~ 105V
4	Vset	195V	180V ~ 205V
5	Vscan	-190V	-170V ~ -205V
6	Vsb	5V	Fixed
7	Vg	15V	Fixed
8	D5VL	5.2V	Fixed
9	D3V3	3.3V	Fixed

Check voltage label on the PDP for correct values.

6.2.7 PSU 50" HD v3

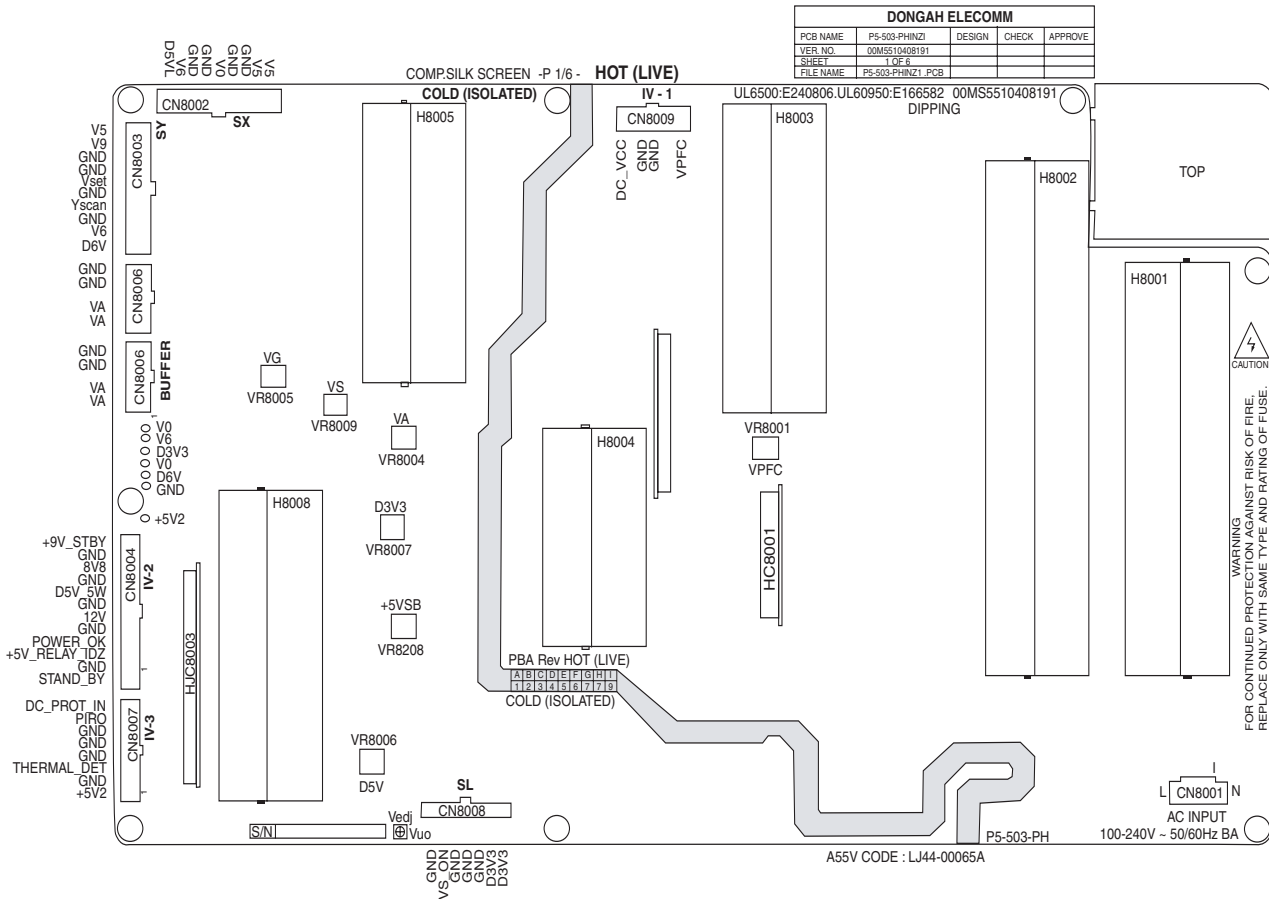

Figure 6-15 PSU layout

Table 6-7 Adjustment voltage level overview

No	Output voltage (V)	Voltage Setting (Normal Load)	Output Voltage Variable Point
1	PFC	385V ± 2V	370V ~ 400V
2	VS	175V ± 1%	160V ~ 185V
3	VA	70V ± 1%	65V ~ 80V
4	VE	160V ± 2%	150V ~ 170V
5	VSET	173V ± 2%	160V ~ 180V
6	VSCAN	-60V ± 2%	-55V ~ -75V
7	D5VL	5.2V ± 2%	4.0V ~ 6.0V
8	D3V3	3.3V ± 2%	2.8V ~ 4.0V
9	VCC	15V ± 5%	Fixed
10	5V2	5.4V ± 3%	3.5V ~ 6.0V
11	9V_Standby	8.5V ~ 9.5V	Fixed

Check voltage label on the PDP for correct values.



# 8. Alignments

**Index of this chapter:**

- 8.1 Alignments 37" SD v4
- 8.2 Alignments 42" SD v2
- 8.3 Alignments 42" SD v3
- 8.4 Alignments 42" HD v3
- 8.6 Alignments 42" HD v4
- 8.7 Alignments 50" HD v3
- 8.8 Alignments 50" HD v4
- 8.9 Alignment value overview (all screens)

**Note:**

- Figures can deviate due to the different model executions.

**Important:** Remove all non-default jumpers and reset all DIP switches, after the repair!

## 8.1 Alignments 37" SD v4

1. Set the pattern to Full White (place jumper CN2008 on the Logic Board).
2. Set Vsch (see Figure "Test point location LJ92-0102A") to -38V (see Figure "Waveform adjustment (Y-Board)"). Check with a digital multimeter, connected between the Y-scan test point and ground. Adjust the voltage with VR5000.
3. Check the waveform using an Oscilloscope.
  - Triggering through V\_TOGG of the LOGIC Board (see Figure "Logic PWB").
  - Connect the "ODD" test point, located at the centre of Y\_buffer (see Figure "Potentiometer locations LJ92-01149A"), to the other channel, and then check the first Subfield waveform of one TV-Field.
  - Check the waveform by adjusting Horizontal Division of the oscilloscope.
4. Adjust the flat time of the rising ramp of the 1st subframe to 40 μS with VR5001 (see Figure "Rising ramp flat time adjustment").

5. Adjust the flat time of the falling ramp of the 1st subframe to 16 μS with VR5002 (see Figure "Falling ramp flat time adjustment").
  - This is a difficult adjustment.
  - It is easier and more accurate to do the following:
    - Count 3 pulses between A and B;
    - Set the difference between A and B to 40 V; the time between C and D will then automatically be set to approximately 16 μS
    - Settings of the oscilloscope: vertically 20VDC/div, horizontally 10 μS/div.
6. Check with the oscilloscope if the voltage of Vsch is -38 V (see Figure "Y-scan H waveform").

**Special notice:** It is very important, that you execute this adjustment on the 1st Sub-Field (SF) of the 1st Frame of the Reset waveform and then move to the 3rd Sub-field for adjusting.

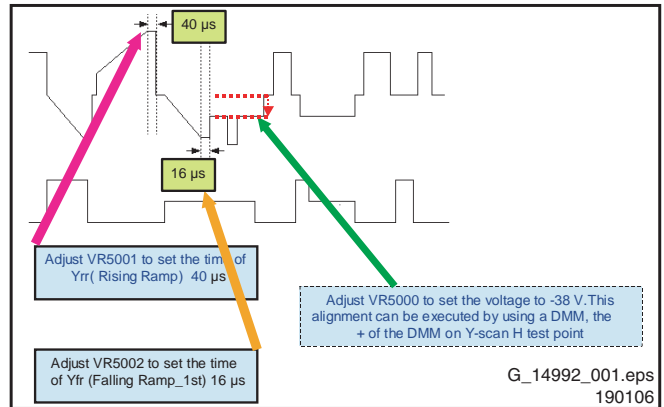

Figure 8-1 Waveform adjustment (Y-Board)

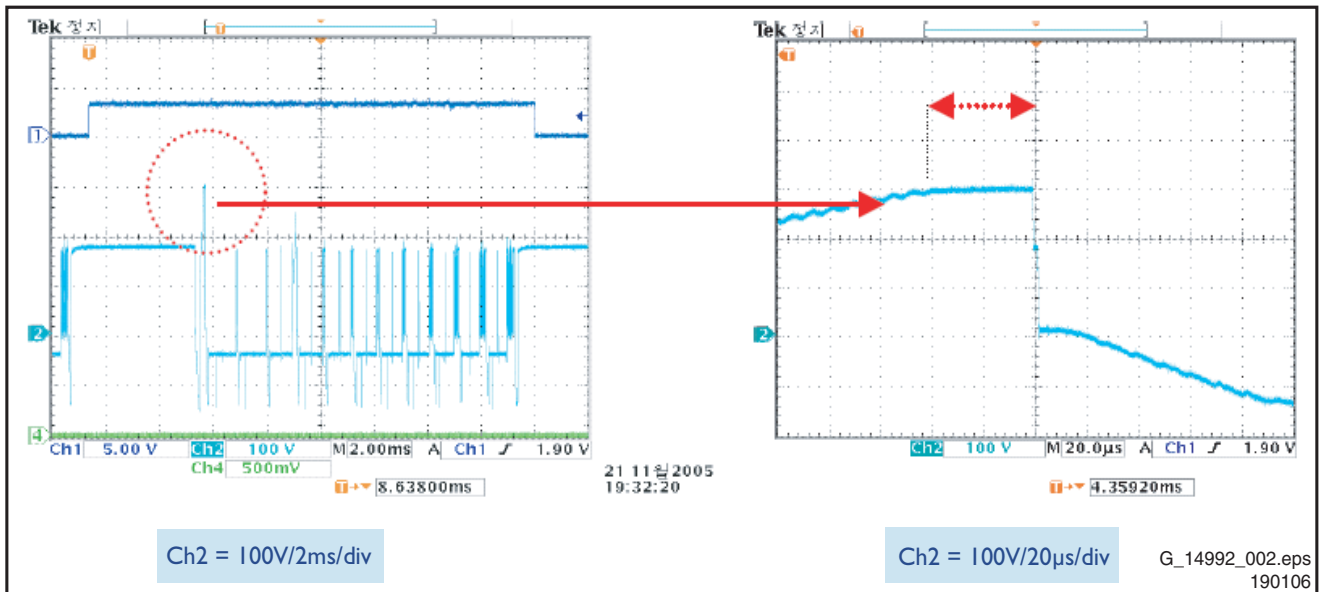

Figure 8-2 Rising ramp flat time adjustment (Y-Board)

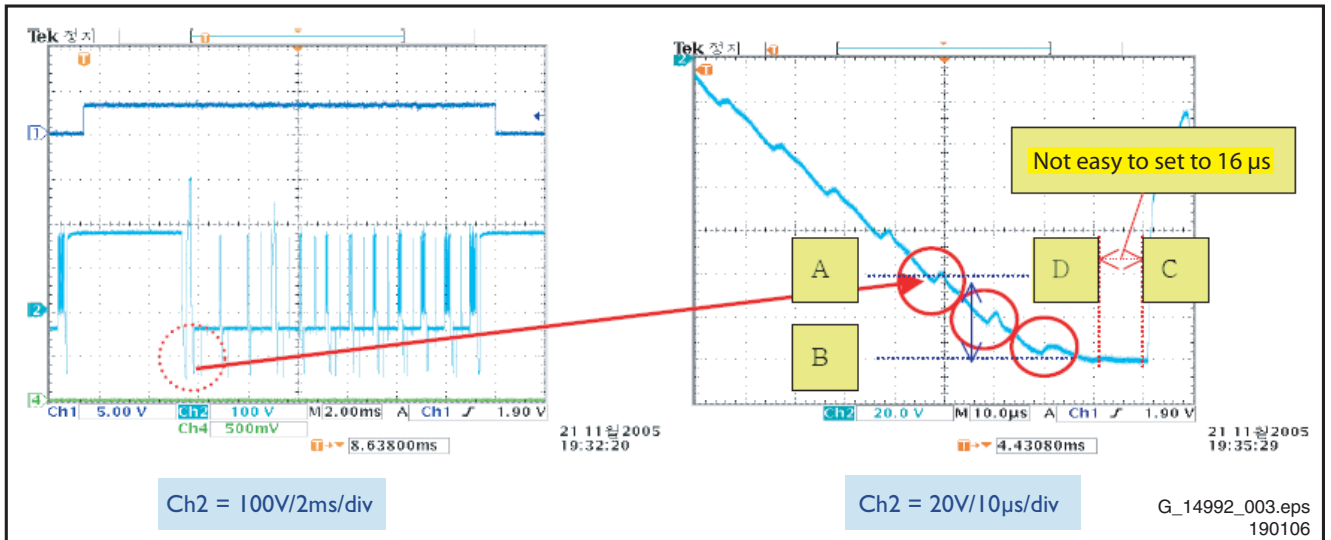

Figure 8-3 Falling ramp flat time adjustment (Y-Board)

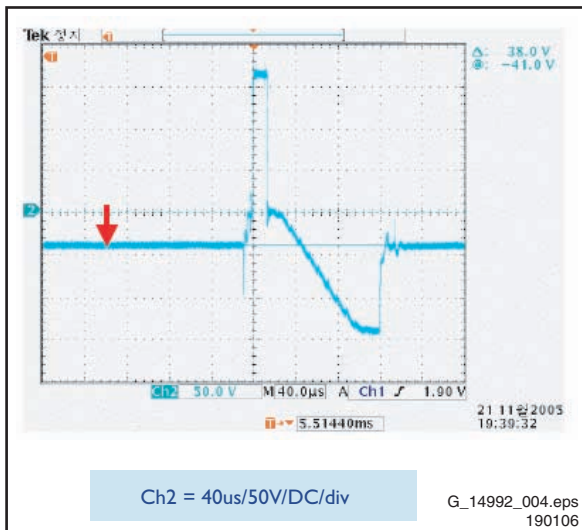

Figure 8-4 Y-scan H waveform (Y-Board)

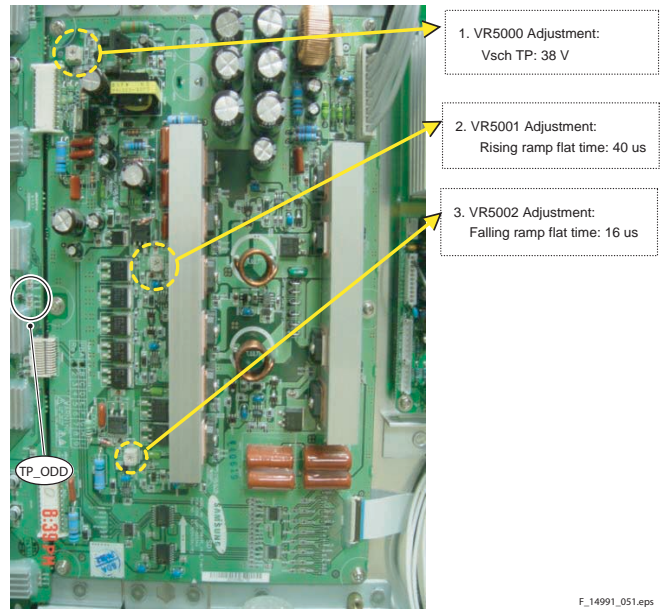

Figure 8-6 Potentiometer locations LJ92-01149A

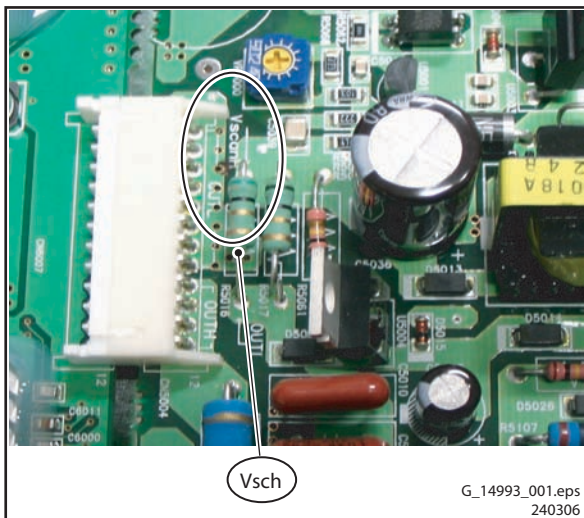
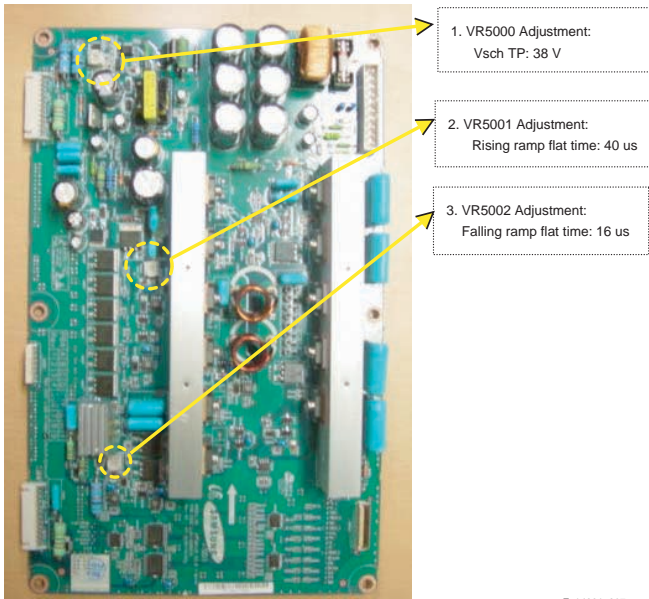
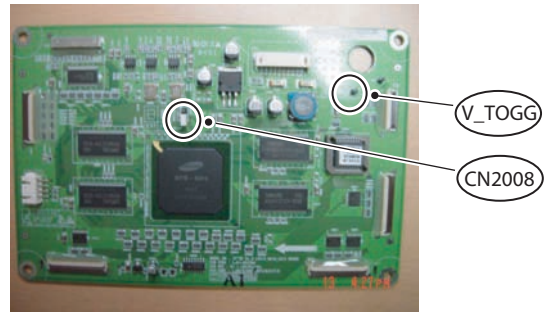

Figure 8-5 Test point location LJ92-01021A



F\_14991\_067.eps  
140206

Figure 8-7 Potentiometer locations LJ92-01149B



LJ92-01056A / LJ92-01145A

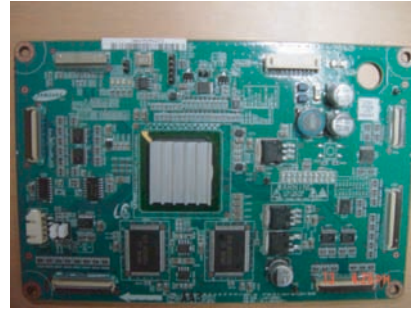

LJ92-01057A

F\_14991\_068.eps  
230306

Figure 8-9 Logic PWB

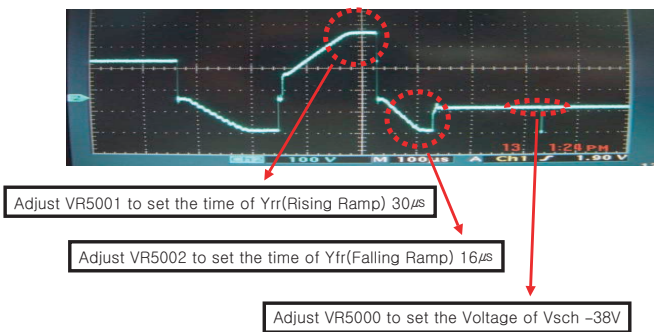

G\_14991\_066.eps  
140206

Figure 8-8 Wave form adjustment (Y-Main board)

## 8.2 Alignments 42" SD v2

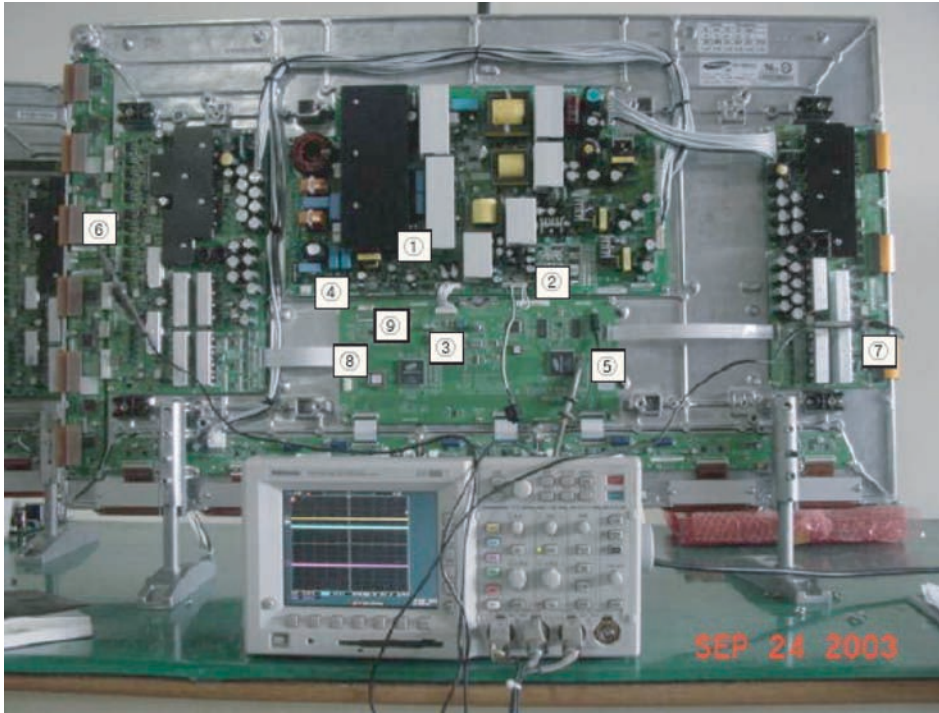

## 1) Preparation

- 1 Insert jumper J8002 on PSU board
- 2 Connect the Jig connector switch
- 3 Put the Logic board dipswitches into internal mode, to generate a Full White screen

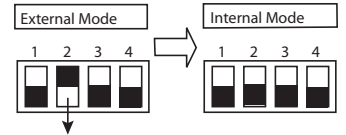

- 4 Connect the AC power jig

Connect the Oscilloscope:

- 5 CH1: V-SYNC (CN201)
- 6 CH2: Y-output (OUT4)
- 7 CH3: X-output (TP OUT)
- 8 Connect the Key-scan Board

## 2) Turn-On.

- Turn on the Power switch
- Check the LED on the Logic Board
- Check waveform of X- and Y-board (Refer to Picture below)

Figure 8-10 Adjusting procedure (42" SD v2)

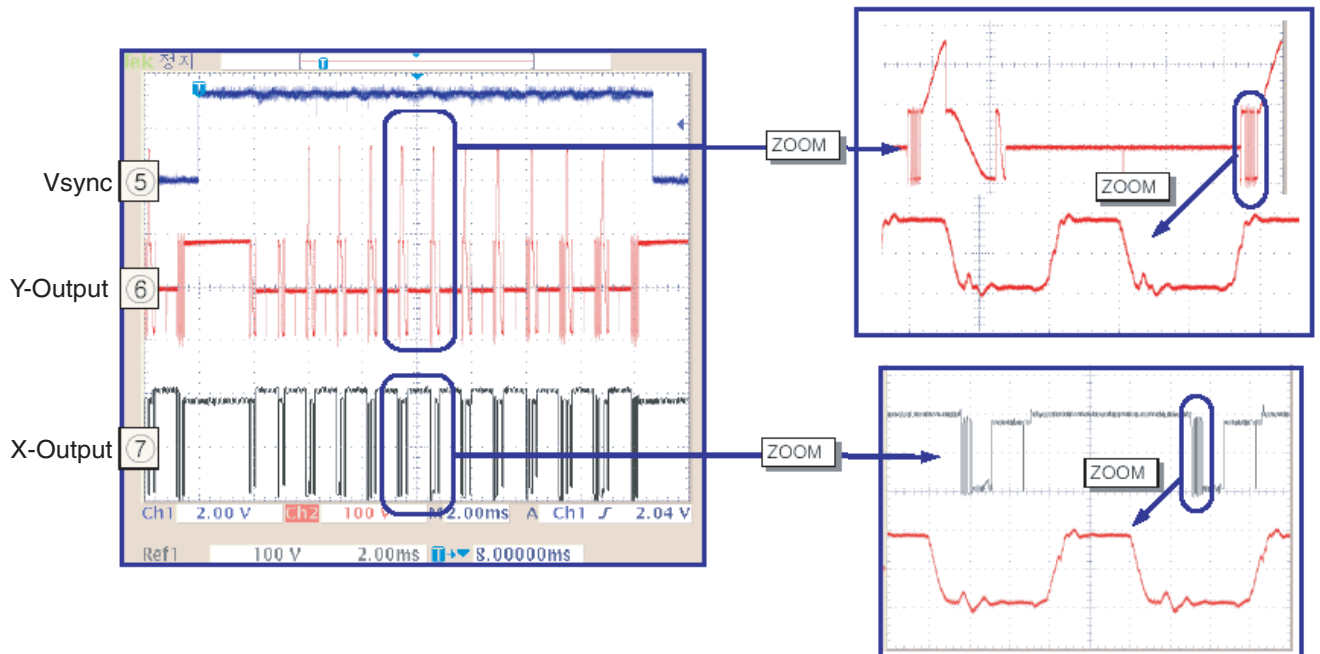

Figure 8-11 Waveform of X- and Y-board (42" SD v2)

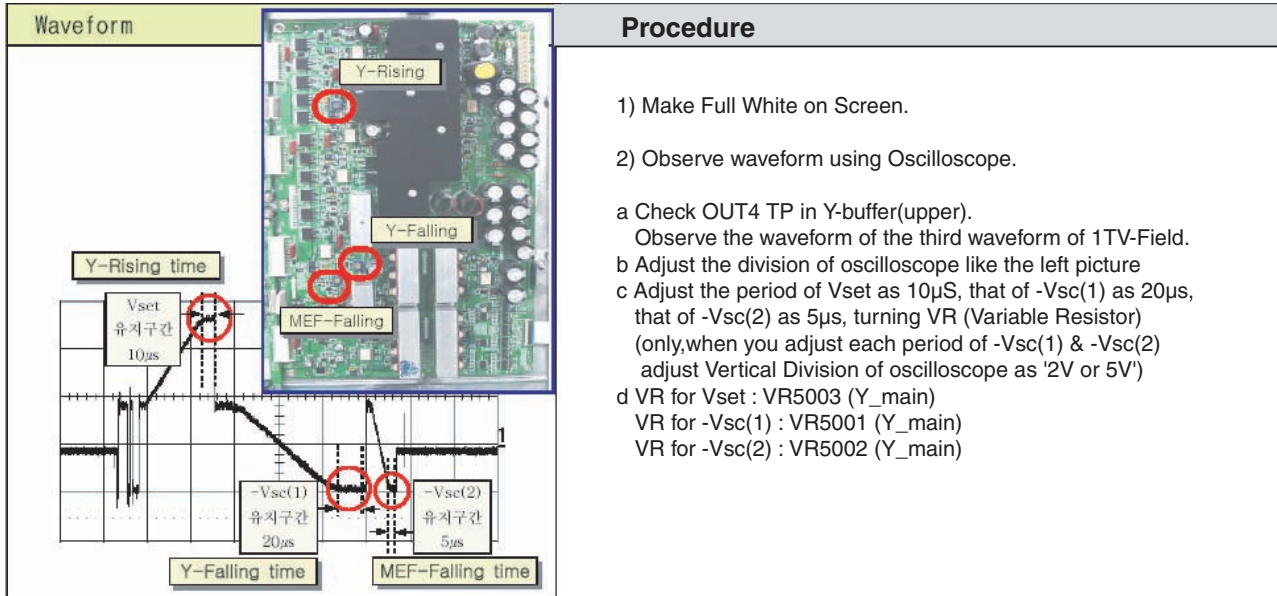

Figure 8-12 How to adjust the waveform (42" SD v2)



### 8.3 Alignments 42" SD v3

1. Put the dipswitches on the Logic Board in the internal position to get a Full White Pattern.
2. You can find the location of the test point and potentiometers in Figure "Potentiometer locations".
3. Adjust  $V_{sch}$  to 40 V with VR5004.
4. Check the waveform with an Oscilloscope.
  - Take the trigger signal from the testpoint marked "V-sync" on the Logic Board.
  - Connect the testpoint marked "OUT 4", located in the centre of Y\_buffer Board to the other channel, and then check the first Subfield operating waveform of one TV-Field.
  - Check the waveform again after adjusting Horizontal Division. Check the Reset waveform when the V\_TOGG Level is changed.
  - Set the  $V_{set}$  to  $10\mu s$  by adjusting VR5002.
  - Set the Falling maintenance time to  $30\mu s$  by adjusting VR5003.
  - Change the waveform position of Oscilloscope to the 3rd Subfield and then set the Falling maintenance time to  $30\mu s$  by adjusting the VR5001. GND maintenance section should be checked after the Vertical Division is readjusted to '2 V or 5 V'.

Reset waveform and then move to the 3rd Sub-field for adjusting.

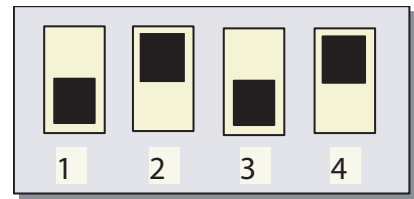

Figure 8-13 DIP switch mode: External

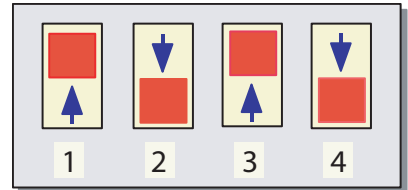

Figure 8-14 DIP switch mode: Internal

**Special notice:** It is very important, that you execute this adjustment on the 1st Sub-Field (SF) of the 1st Frame of the

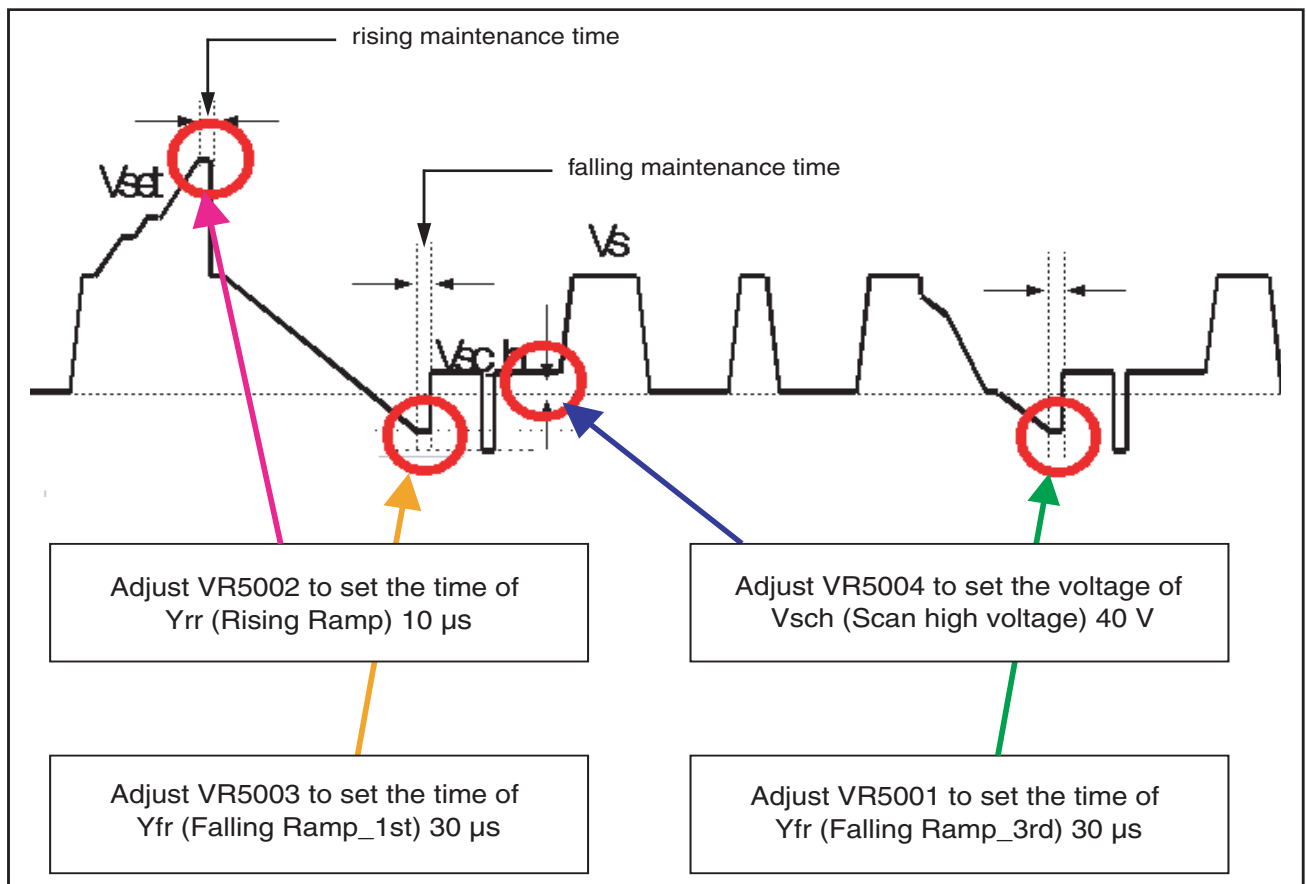

Figure 8-15 TCP ramp waveform inclination adjustment (Y-Board)

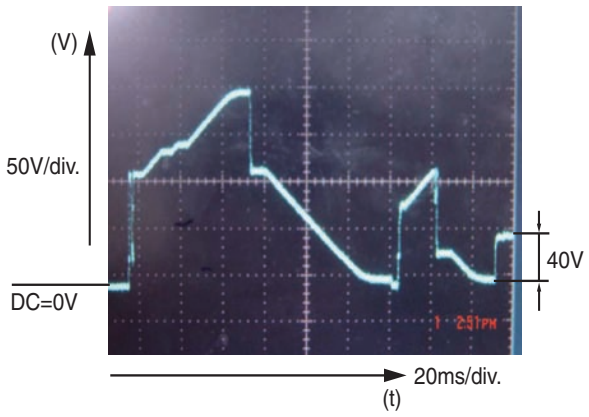

Figure 8-16 Rising ramp

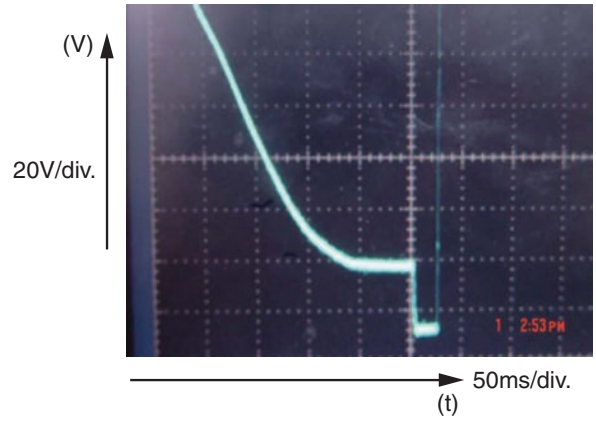
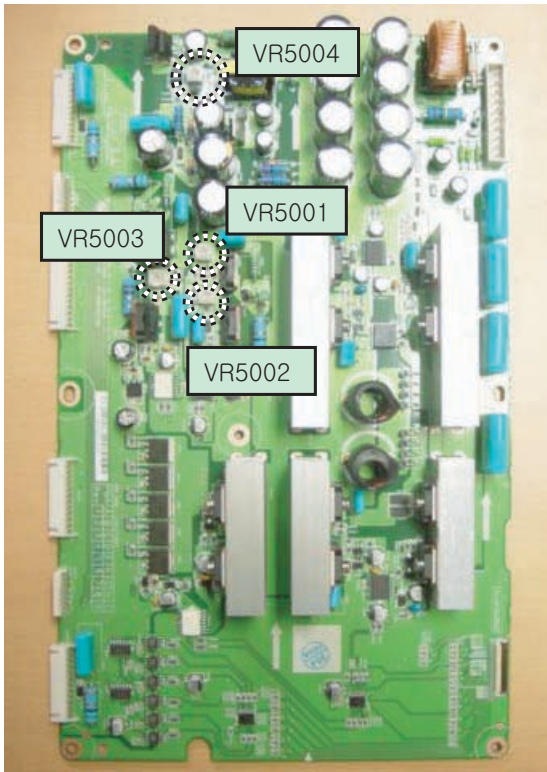

Figure 8-17 Falling ramp

- 1. VR5004 Adjustment: Vsch TP => 40 volt
- 2. VR5002 Adjustment: Rising Ramp flat time: Typ. 10  $\mu$ sec
- 3. VR5003 Adjustment: Falling Ramp flat time => Typ. 30  $\mu$ sec
- 4. VR5001 Adjustment: 3rd SF Falling Ramp flat time => Typ. 30  $\mu$ sec

\* Pay close attention to above adjustment

Figure 8-18 Potentiometer locations



LJ92-01284A

F\_14991\_070.eps  
140206

Figure 8-19 Potentiometer locations LJ92-01284A

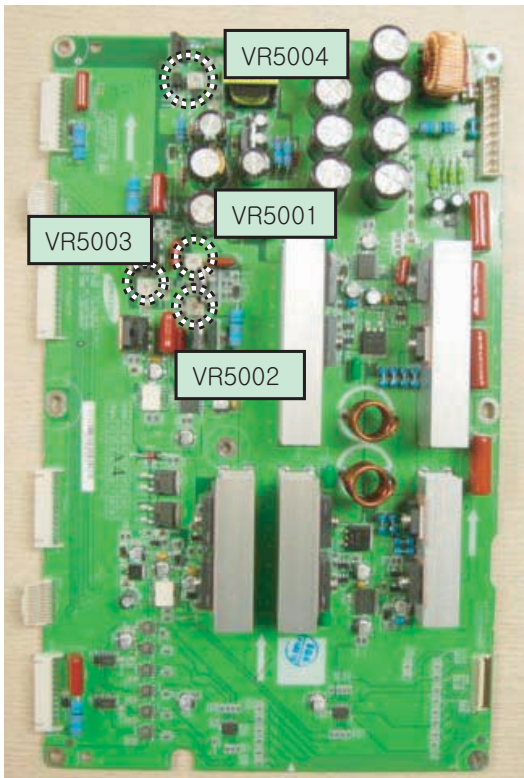

LJ92-00944B

F\_14991\_069.eps  
140206

Figure 8-20 Potentiometer locations LJ92-00944B

8.4 Alignments 42" HD v3

1. Put the dipswitches on the Logic Board in the internal position to get a Full White Pattern.
2. Adjust Vsch to Clock-wise max by using VR5004 (Vsch should be connected to "+" unit of DMM).
3. Check the waveform using Oscilloscope.
  - Triggering through V\_TOGG of LOGIC Board.
  - Connect the OUT 4 Test Point at the centre of Y\_buffer to other channel, and then check the first Subfield operating waveform of one TV-Field.
  - Check the waveform again after adjusting Horizontal Division. Check the Reset waveform when the V\_TOGG Level is changed.
  - Set the Vset to 20  $\mu$ s by adjusting VR5002. GND maintenance section should be checked after the Vertical Division is readjusted to '2 V or 5 V'.
  - Set the Falling maintenance time to 20  $\mu$ s by adjusting VR5006.
  - Change the waveform position of Oscilloscope to the 3rd Subfield and then set the Falling maintenance time to 10 $\mu$ s by adjusting the VR5003. GND maintenance section should be checked after the Vertical Division is readjusted to '2 V or 5 V'.

Reset waveform and then move to the 3rd Sub-field for adjusting.

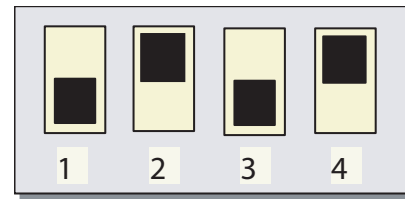

Figure 8-21 DIP switch mode: External

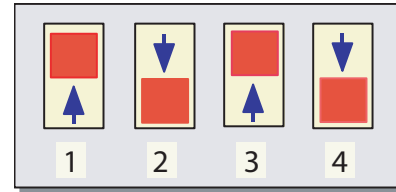

Figure 8-22 DIP switch mode: Internal

**Special notice:** It is very important, that you execute this adjustment on the 1st Sub-Field (SF) of the 1st Frame of the

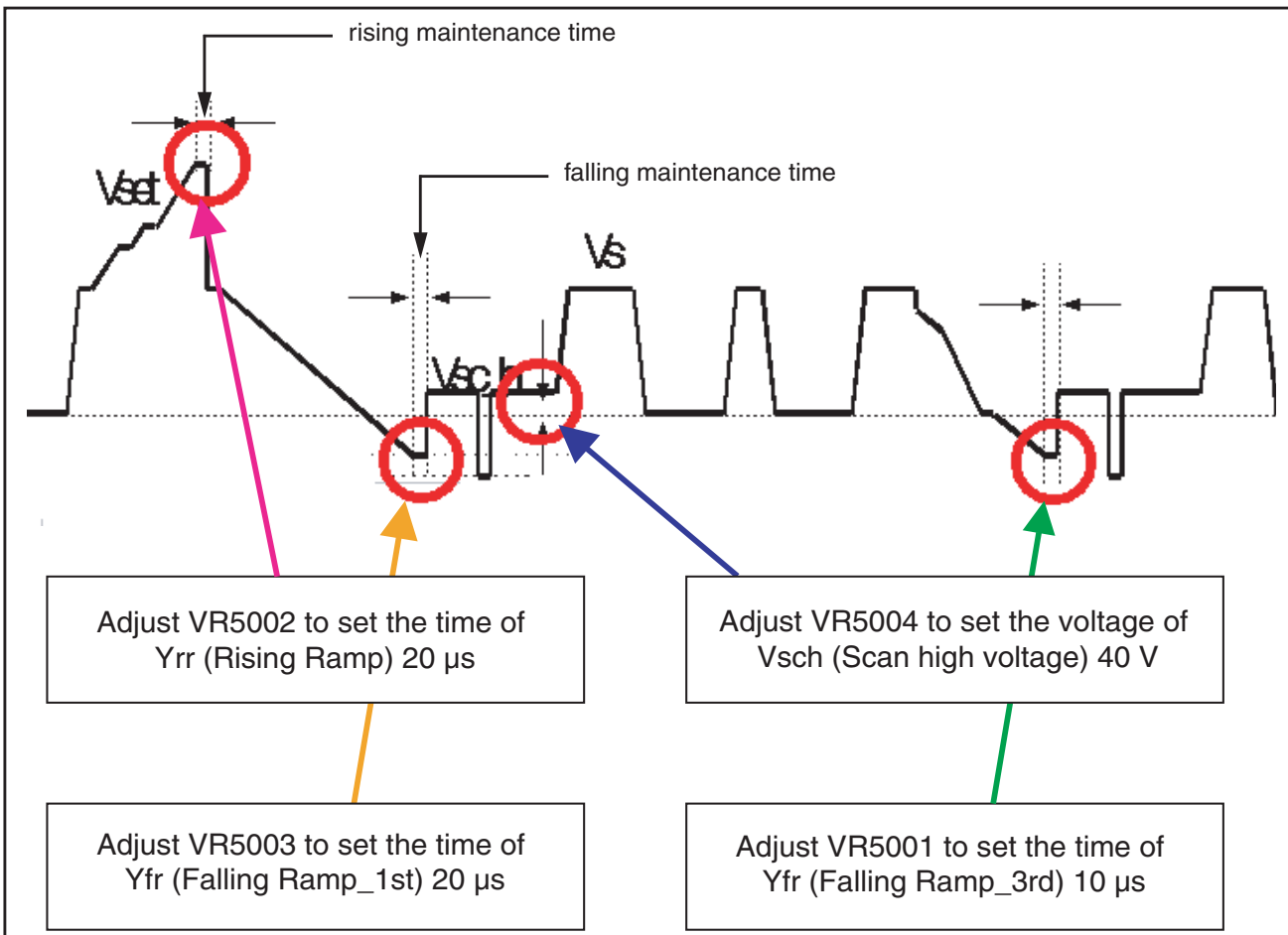

Figure 8-23 TCP ramp waveform inclination adjustment (Y-Board)

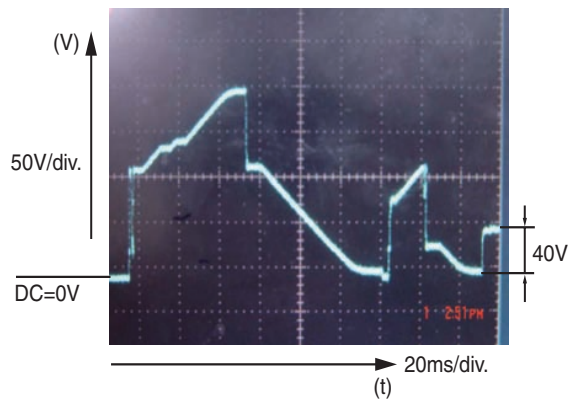

Figure 8-24 Rising ramp

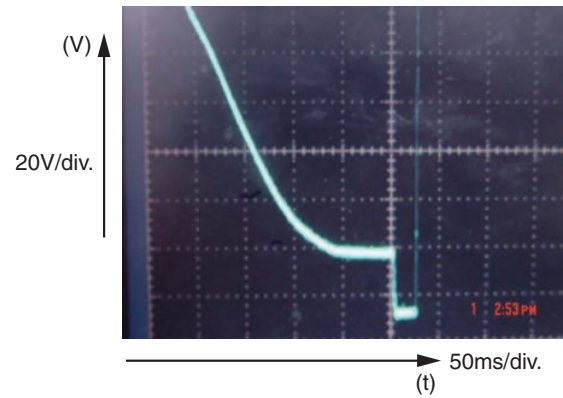

Figure 8-25 Falling ramp

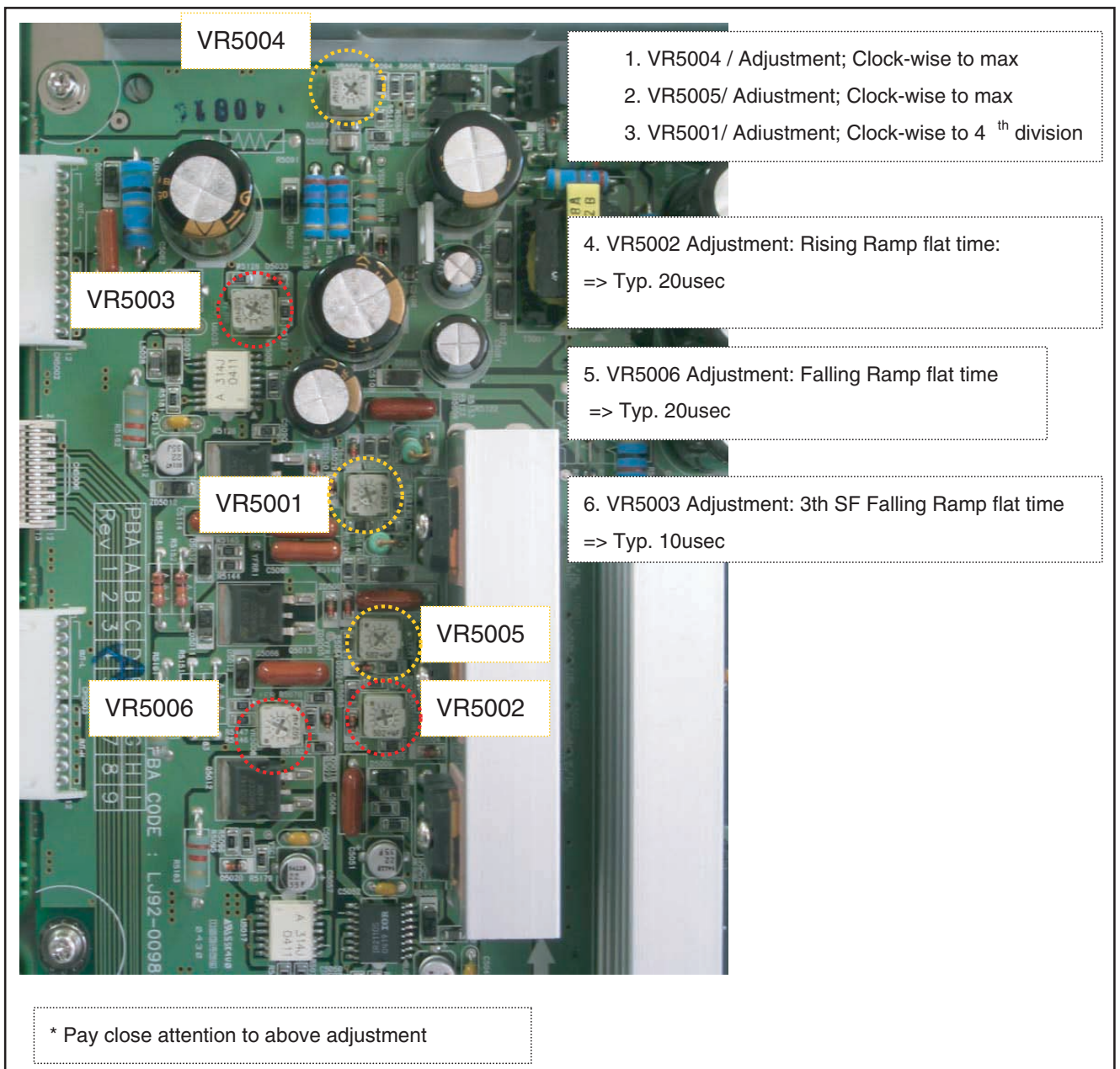
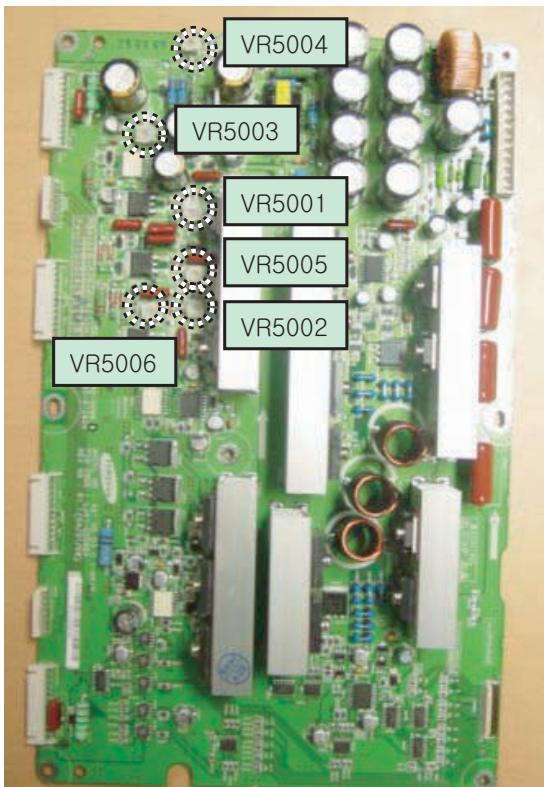

Figure 8-26 Potentiometer locations



LJ92-00981A

F\_14991\_071.eps  
140206

Figure 8-27 Potentiometer locations LJ92-00981A

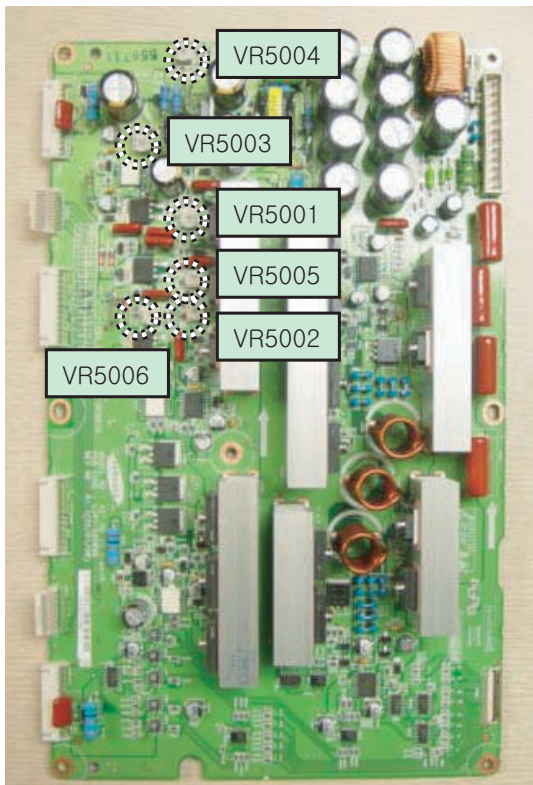

LJ92-00981B

F\_14991\_072.eps  
140206

Figure 8-28 Potentiometer locations LJ92-00981B

8.5 Alignments 42" SD v4

1. Get Pattern to be Full White (place jumper CN2034 on Logic Board).
2. Check the waveform using an Oscilloscope.
  - Triggering through V\_TOGG of LOGIC Board.
  - Connect the OUT 240 Test Point at the centre of Y\_buffer to other channel, and then check the first aid-reset waveform from the last sustain of 1TV-Field.

- Check the waveform again after adjusting Horizontal Division.  
Check the Reset waveform when the V\_TOGG Level is changed.
- Adjust the flat time of the rising ramp to 60µs with VR5001.
- Adjust the flat time of the falling ramp to 80µs with VR5003.

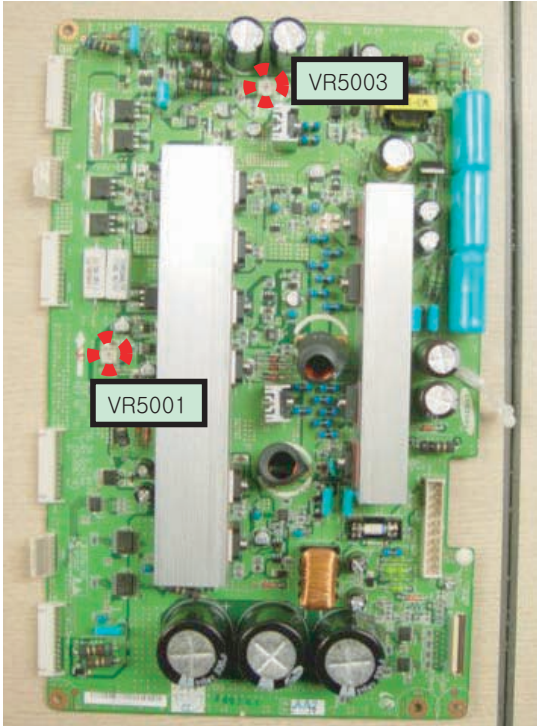

1.VR5001 Adjustment : Rising Ramp flat time :  
→ 60 µs

2.VR5003 Adjustment : Falling Ramp flat time :  
→ 80 µs

LJ92-01337A

F\_14991\_074.eps  
140206

Figure 8-29 Potentiometer locations

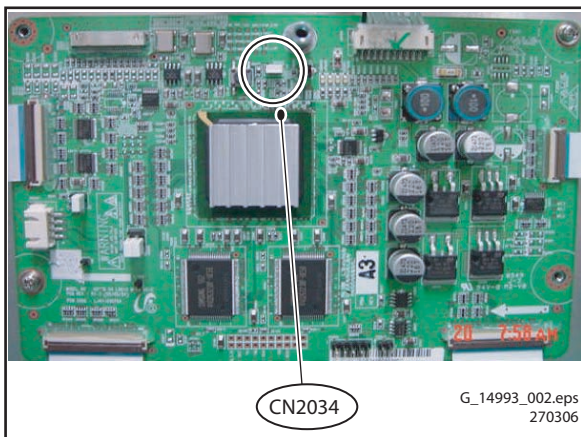

G\_14993\_002.eps  
270306

Figure 8-30 Jumper location (Logic board)

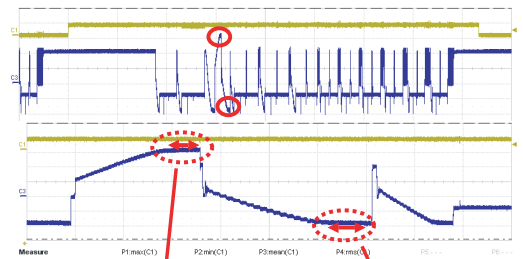

Adjust VR5001 to set the time of Yrr(Rising Ramp) 60µs

Adjust VR5003 to set the time of Yfr(Falling Ramp) 80µs

F\_14991\_073.eps  
140206

Figure 8-31 Wave form adjustment (Y-Main board)

8.6 Alignments 42" HD v4

1. Get Pattern to be Full White (place jumper CN2072 on Logic Board).
2. Check the waveform using an Oscilloscope.
  - Triggering through V\_TOGG of LOGIC Board.
  - Connect the OUT 240 Test Point at the centre of Y\_buffer to other channel, and then check the first aid-reset waveform from the last sustain of one TV-Field.
  - Check the waveform again after adjusting Horizontal Division.
  - Check the Reset waveform when the V\_TOGG Level is changed.
  - Set the 15V by adjusting VR5002.
  - Set the 100V and 50us by adjusting VR5001

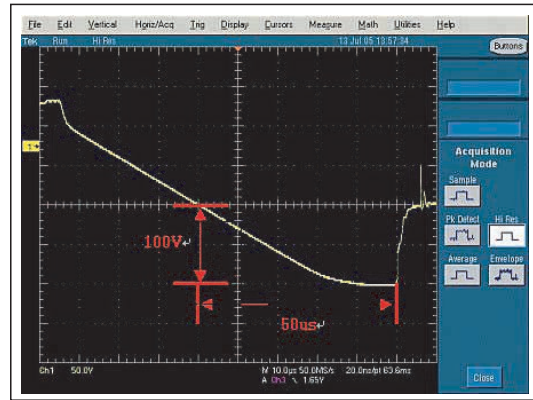

F\_14991\_025.eps 030805

Figure 8-35 Falling ramp of aid-reset

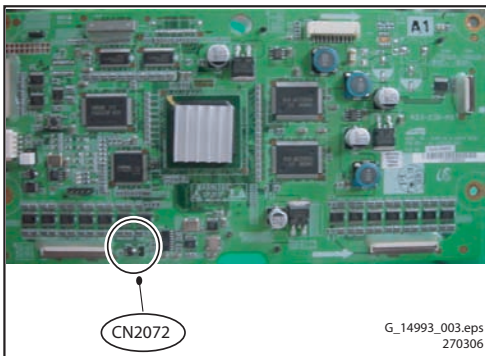

G\_14993\_003.eps 270306

Figure 8-32 Jumper location (Logic board)

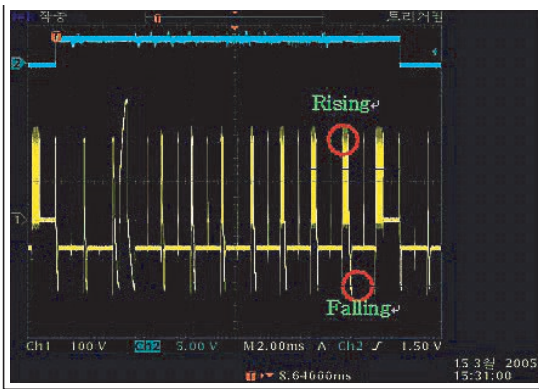

F\_14991\_023.eps 030805

Figure 8-33 1st subfield from the last sustain within 1 frame

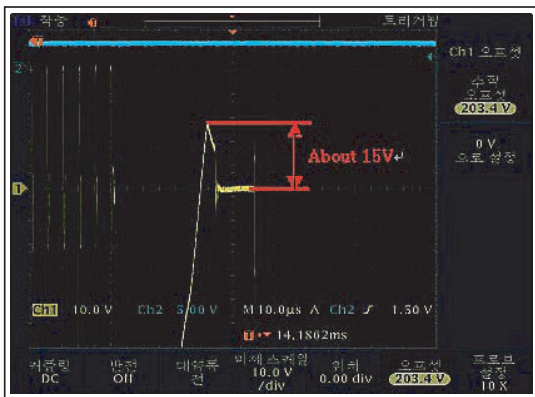

F\_14991\_024.eps 030805

Figure 8-34 Rising ramp of aid-reset

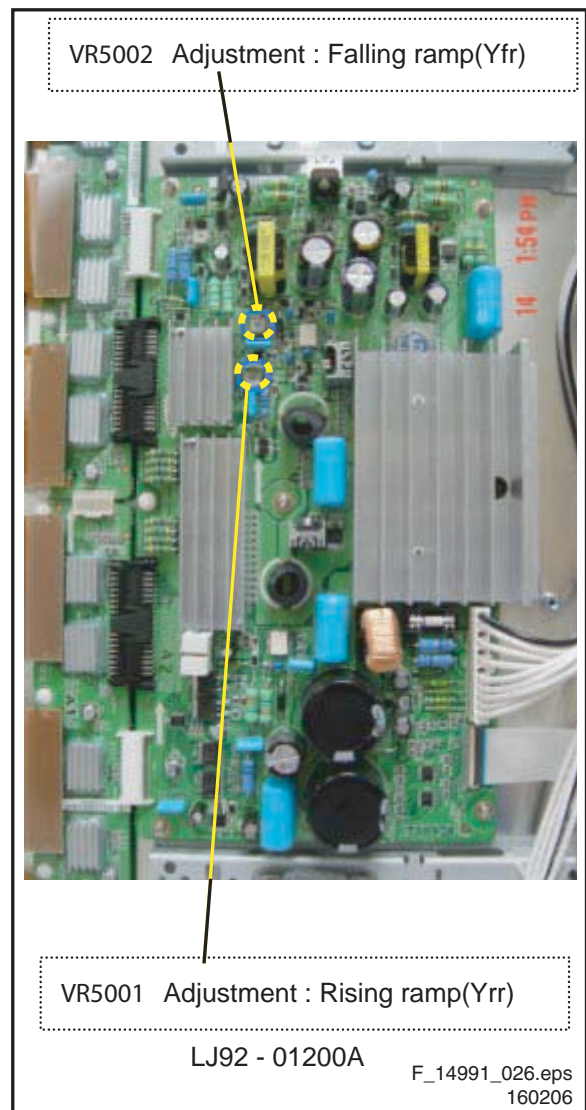

LJ92 - 01200A

F\_14991\_026.eps 160206

Figure 8-36 Potentiometer locations



## 8.7 Alignments 50" HD v3

- Put the dipswitches on the Logic Board in the internal position to get a Full White Pattern (see Figure "DIP switch positions").
- Adjust  $V_{sch}$  to 25 V by using VR5901\_VSC\_h ( $V_{sch\_h}$  should be connected to "+" unit of DMM).
- Check the waveform using Oscilloscope.
  - Triggering through V\_TOGG of LOGIC Board.
  - Connect the OUT 4 Test Point at the centre of Y\_buffer to other channel, and then check the first Subfield operating waveform of one TV-Field.
  - Check the waveform again after adjusting Horizontal Division. Check the Reset waveform when the V\_TOGG Level is changed.
  - Set the Rising Ramp Flat Time to 50  $\mu$ s by adjusting VR5000. GND maintenance section should be

checked after the Vertical Division is readjusted to '2 V or 5 V'.

- Set the Falling maintenance time to 35  $\mu$ s by adjusting VR5001.
- Change the waveform position of Oscilloscope to the 3rd Subfield and then set the Falling maintenance time to 20  $\mu$ s by adjusting the VR5002.
- GND maintenance section should be checked after the Vertical Division is readjusted to '2 V or 5 V'.

**Special notice:** When you adjust the inclination of waveform, do check and adjustment being based on the Reset waveform of 1st Sub-field of 1st Frame and then move to 3rd Sub-field for adjusting.

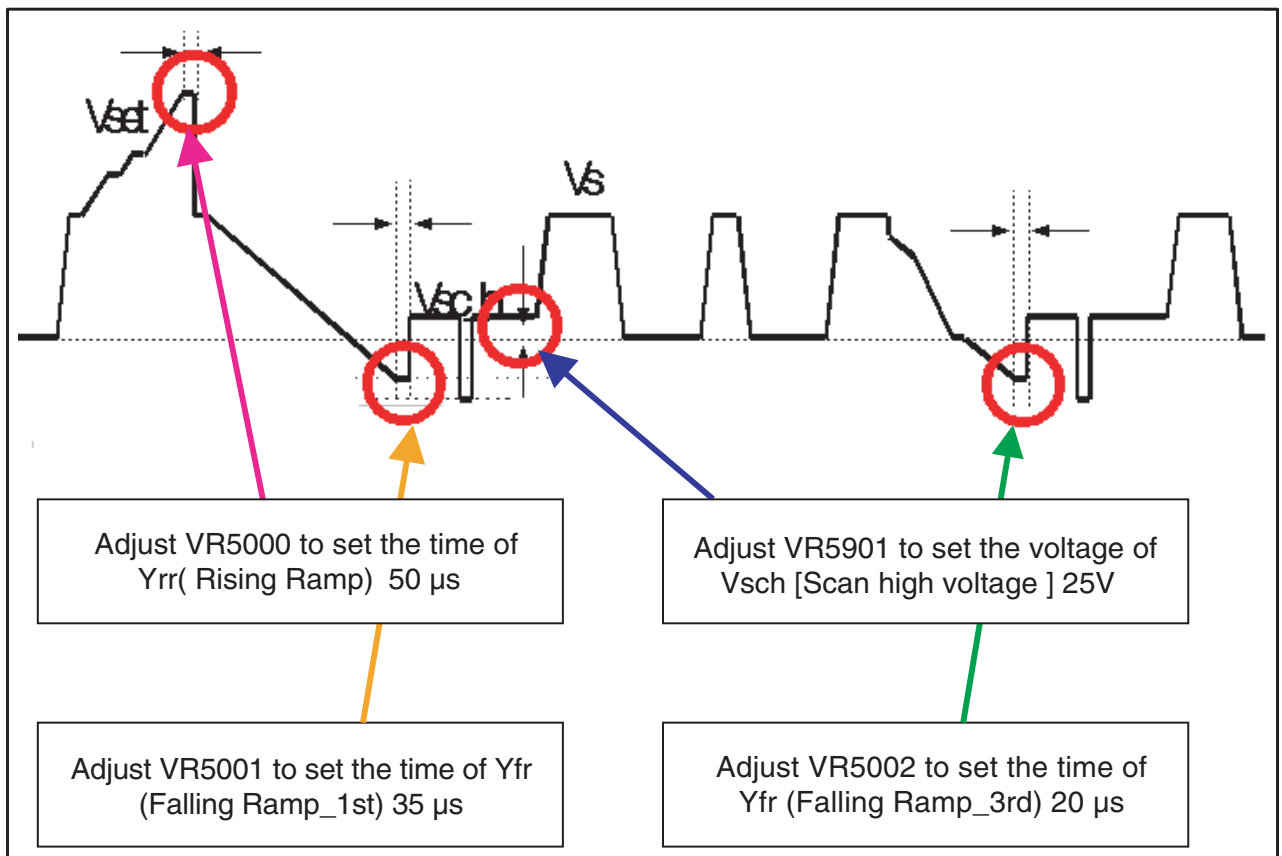

Figure 8-37 TCP ramp waveform inclination adjustment (Y-Board)

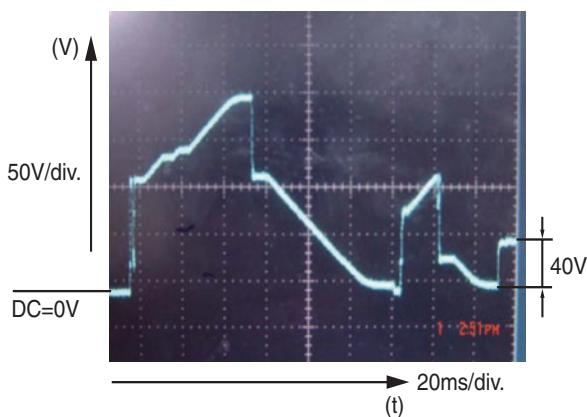

Figure 8-38 Rising ramp

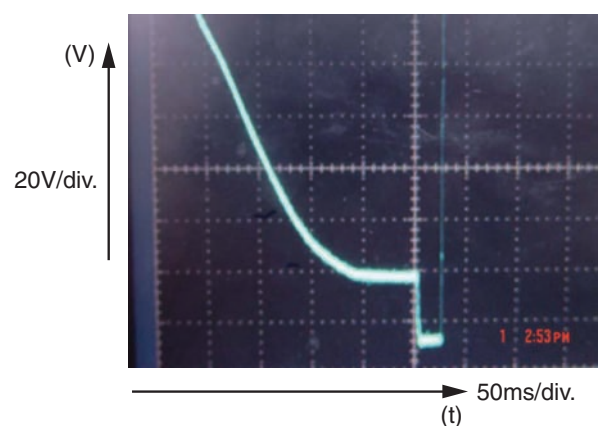

Figure 8-39 Falling ramp

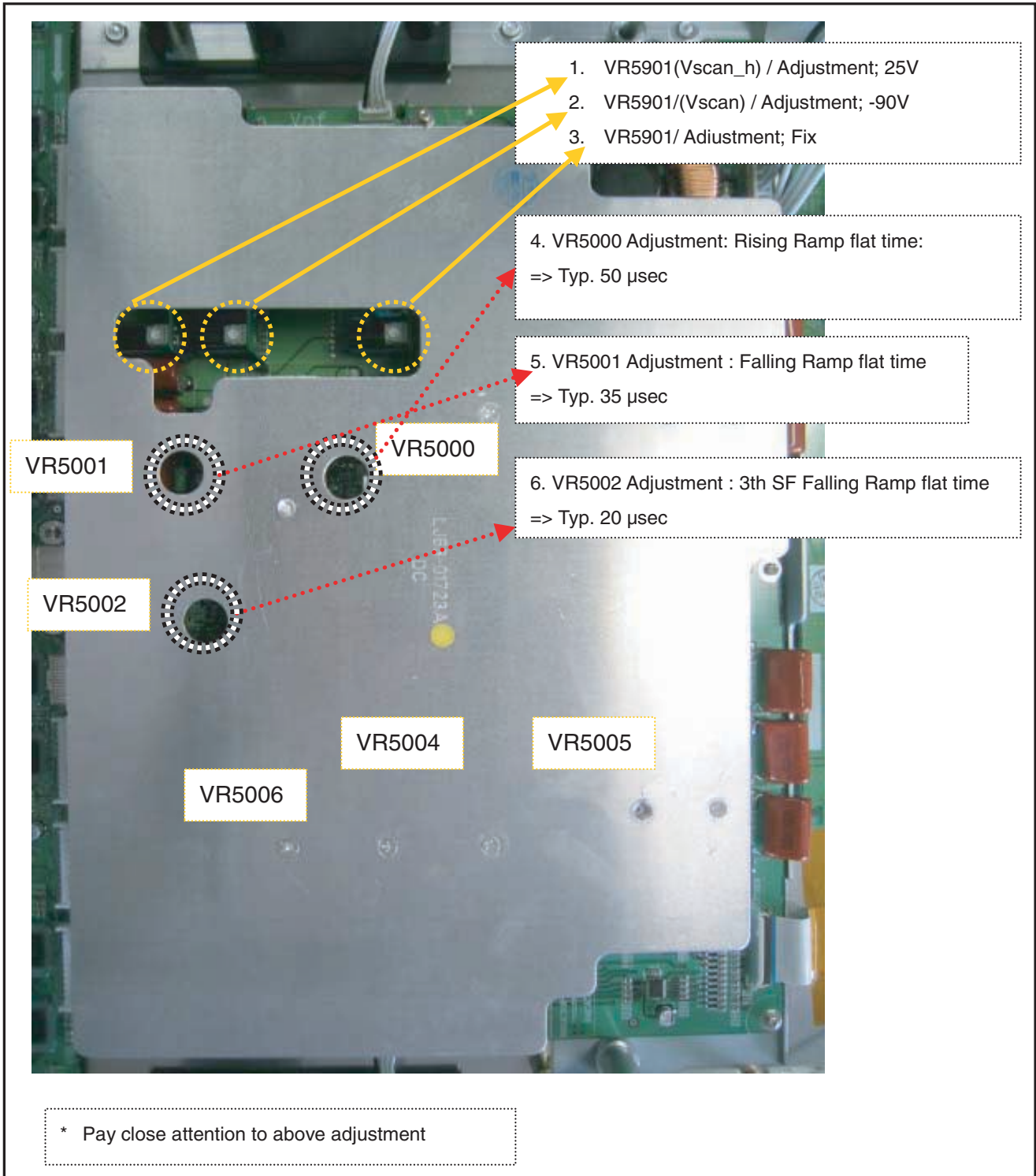
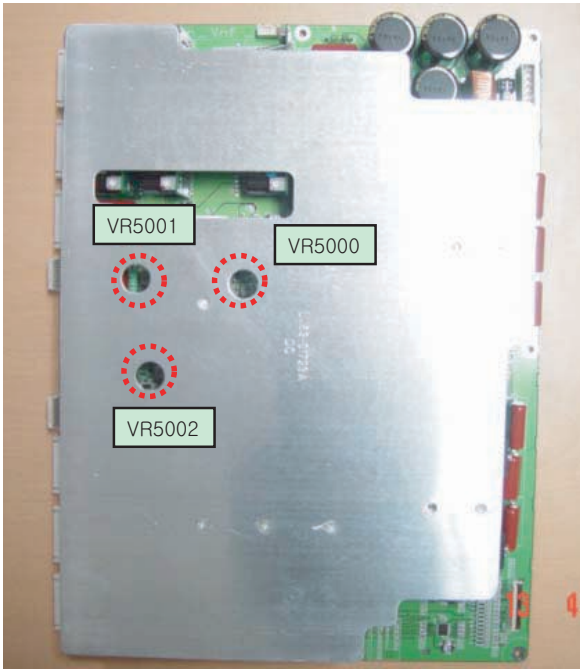

Figure 8-40 Potentiometer locations



LJ92-00853A

F\_14991\_076.eps  
140206

Figure 8-41 Potentiometer locations LJ92-00853A

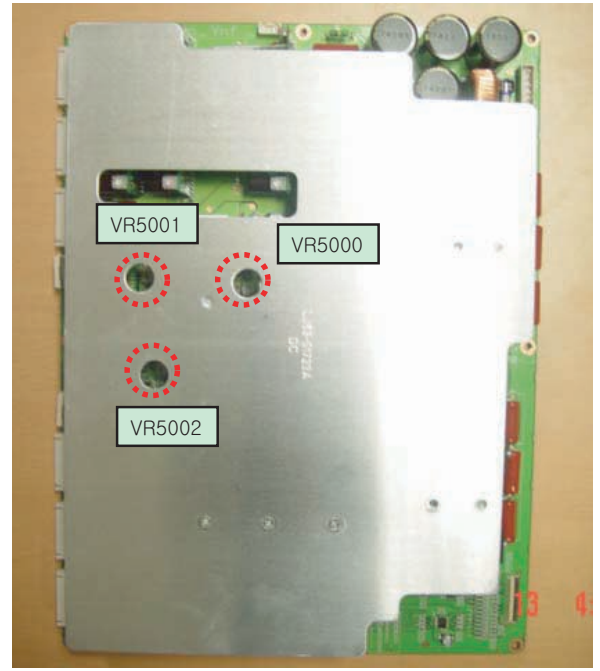

LJ92-00853B

F\_14991\_077.eps  
140206

Figure 8-42 Potentiometer locations LJ92-00853B



< External >

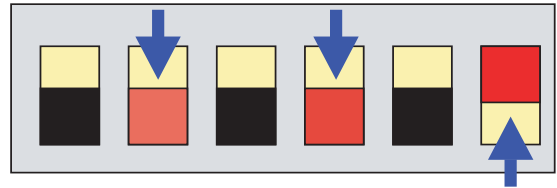

< Internal >

F\_14991\_050.eps  
230306

Figure 8-43 DIP switch positions

8.8 Alignments 50" HD v4

1. Get Pattern to be Full White (place jumper CN2012 on Logic Board).
2. Locate all testpoints and potentiometers of the board at hand.
  - Triggering through V\_TOGG of LOGIC Board.
  - Connect the CN511 Test Point at the Y\_buffer to other channel, and then check the first Subfield operating waveform of one TV-Field.

- Check the waveform again after adjusting Horizontal Division. Check the Reset waveform when the V\_TOGG Level is changed.
- Set the Rising Ramp Flat Time to 90  $\mu$ s by adjusting VR5000.
- Set the Falling maintenance time to 80  $\mu$ s by adjusting VR5001.

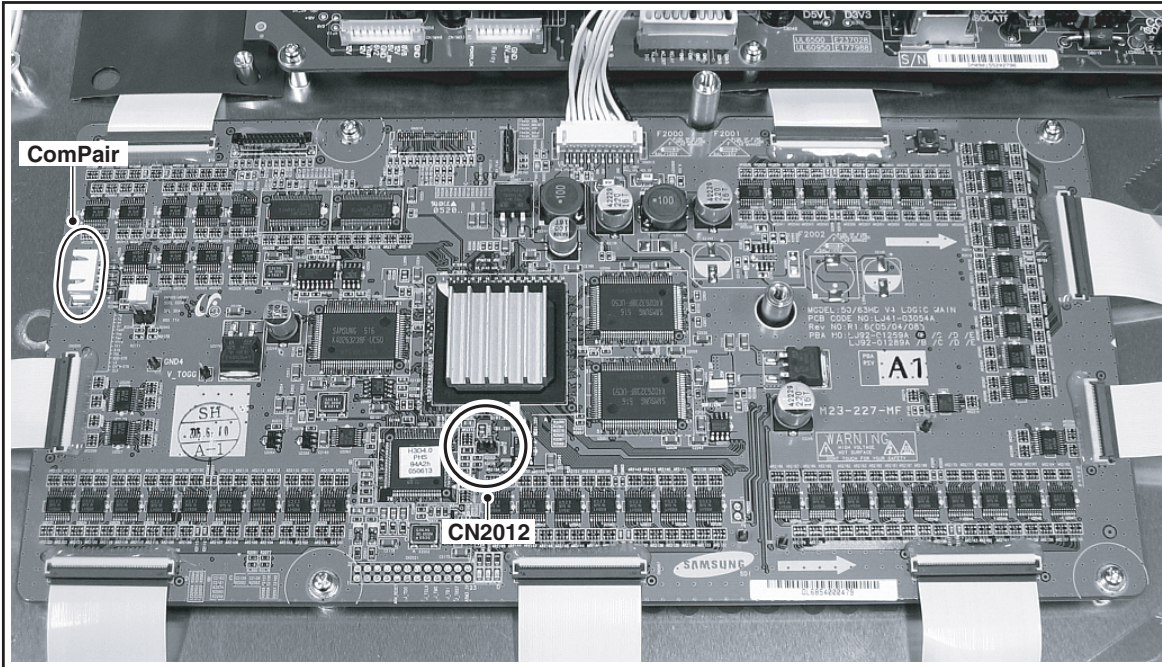

F\_14991\_052.eps  
081105

Figure 8-44 Jumper CN2012 / ComPair connector on v4 Logic board

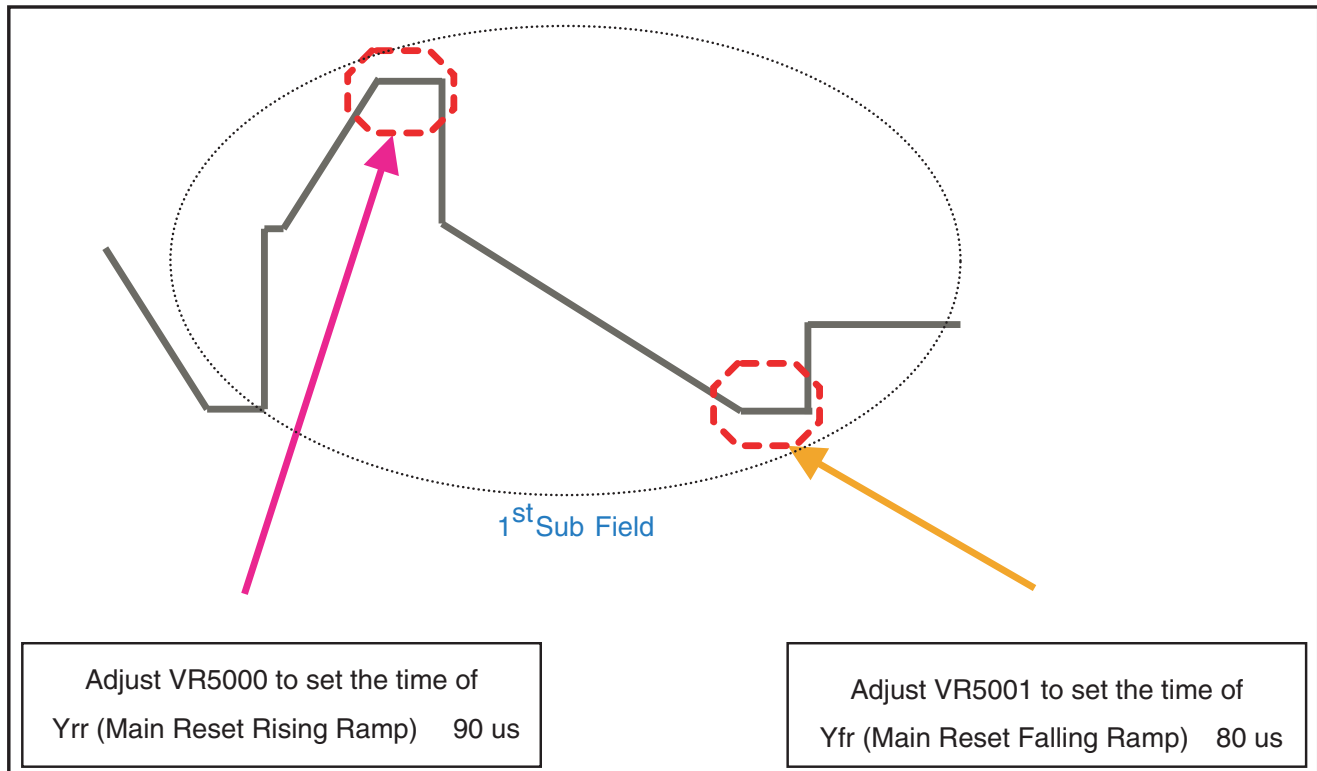
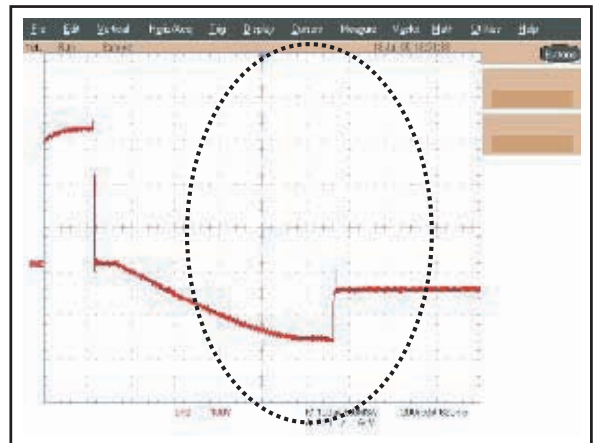

Figure 8-45 TCP ramp waveform inclination adjustment (Y-Board)



F\_14991\_021a.eps  
030805

Figure 8-46 Rising ramp



F\_14991\_021b.eps  
030805

Figure 8-47 Falling ramp

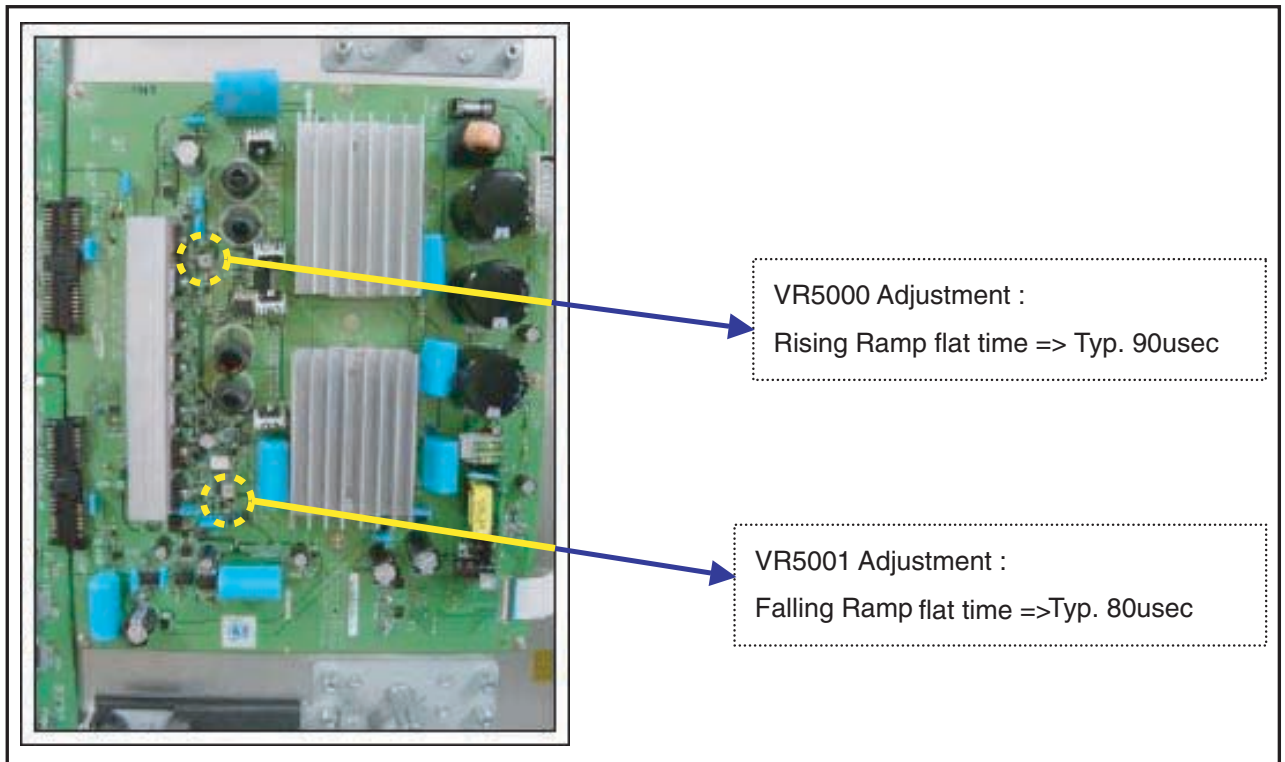

F\_14991\_022.eps  
030805

Figure 8-48 Potentiometer locations



## 9. Circuit Descriptions, Abbreviation List, and IC Data Sheets

### Index of this chapter:

- 9.1 Main function of Each Assembly
- 9.2 Abbreviation List
- 9.3 IC Data Sheets

### 9.1 Main function of Each Assembly

#### 9.1.1 X Main Board

The X Main board generates a drive signal by switching the FET in synchronization with logic main board timing, and supplies the X electrode of the panel with the drive signal through the connector.

1. Maintain voltage waveforms (including ERC).
2. Generate X rising ramp signal.
3. Maintain  $V_e$  bias between Scan intervals.

#### 9.1.2 Y Main Board

The Y Main board generates a drive signal by switching the FET in synchronization with the logic Main Board timing and sequential supplies the Y electrode of the panel with the drive signal through the scan driver IC on the Y-buffer board. This board connected to the panel's Y terminal has the following main functions.

1. Maintain voltage waveforms (including ERC).
2. Generate Y-rising Falling Ramp.
3. Maintain V scan bias.

#### 9.1.3 Logic Main Board

The Logic Main board generates and outputs the address drive output signal and the X,Y drive signal by processing the video signals. This Board buffers the address drive output signal and feeds it to the address drive IC (COF module, video signal- X Y drive signal generation, frame memory circuit / address data rearrangement).

#### 9.1.4 Logic Buffer (E, F)

The Logic Buffer transmits data signal and control signal.

#### 9.1.5 Y Buffer Board (Upper, Lower)

The Y Buffer board consisting of the upper and lower boards supplies the Y-terminal with scan waveforms. The board comprises eight scan driver ICs (ST microelectronics STV 7617: 64 or 65 output pins), but four ICs for the SD class.

#### 9.1.6 AC Noise Filter

The AC Noise filter has function for removing noise (low frequency) and blocking surge. It affects safety standards (EMC, EMI).

#### 9.1.7 TCP (Tape Carrier Package)

The TCP applies the  $V_a$  pulse to the address electrode and constitutes address discharge by the potential difference between the  $V_a$  pulse and the pulse applied to the Y electrode. The TCP comprise four data driver ICs (STV7610A: 96 pins output pins). Seven TCPs are required for signal scan.

### 9.2 Abbreviation List

AC	Alternating Current
COF	Circuit On Foil
DC	Direct Current
ERC	Energy Recovery Circuit
ESD	Electro Static Discharge
FET	Field Effect Transistor
FFC	Flat Foil Cable
FPC	Flexible Printed Circuit
FTV	Flat TeleVision
HD	High Definition
I/O	Input/Output
IC	Integrated Circuit
LB	Logic Buffer
LED	Light Emitting Diode
LVDS	Low Voltage Differential Signalling
PCB	Printed Circuit Board (same as PWB)
PDP	Plasma Display Panel
PSU	Power Supply Unit
PWB	Printed Wiring Board (same as PCB)
RGB	Red, Green, Blue colour space
SD	Standard Definition
SDI	Samsung Display Industry (supplier)
SMPS	Switched Mode Power Supply
SSB	Small Signal Board
SF	Sub Field
TCP	Tape Carrier Package
VR	Variable Resistor
Vsc	Scan Voltage
YBL	Y Buffer Lower board
YBU	Y Buffer Upper board
YM	Y Main board

### 9.3 IC Data Sheets

Not applicable.

## 10. Spare Parts List

### Notes;

- Determine the SDI part / model number of the PDP
- Find the SDI part number on the actual board to be replaced.  
SDI part number begin with "LJ92" and for the SMPS and sub SMPS the part number will begin with "LJ44".
- Find the SDI board part number in the spare parts overview.
- Find the SDI part number in this overview that matches the part number that is actually on the original board.
- Cross the SDI board part number to the philips part number.
- Order the philips part number.

- **Note:** The appearance of a leaded and lead-free board can be different; the colour of the PWB and also the layout of the components are sometimes different.



E\_06532\_026.eps  
081105

Figure 10-1 Lead-free logo SDI

Table 10-1 Spare parts overview 37" SD v4

PDP type	37" SD v4				
PDP 12NC	9322 217 39682 (8204 000 77261)				
PDP model type and version	S37SD-YD02				
Remarks	Lead type boards being not compatible with lead free type will not be phased out			Lead Free type being compatible with Lead type PWB	
Boards	Codes for lead type PWB's		Codes for lead-free type PWB's		
Logic-Buffer (E)	LJ92-00976A	9965 000 26187	LJ92-01138B	9965 000 32616	N
Logic-Buffer (F)	LJ92-00977A	9965 000 26188	LJ92-01139B	9965 000 32617	N
Logic-Buffer (G)	LJ92-01002A	9965 000 26189	LJ92-01140B	9965 000 32618	N
Logic-Buffer (H)	-	-	-	-	-
Logic-Buffer (I)	-	-	-	-	-
Logic-Buffer (J)	-	-	-	-	-
Y-Buffer (up)	LJ92-01022A	9965 000 26190	LJ92-01147A	9965 000 32619	N
Y-Buffer (down)	-	-	-	-	-
Logic-Board	LJ92-01056A (See Kit 1 Note) LJ92-01145A (See Kit 2 Note)	9965 000 26191	LJ92-01257A	9965 000 29322	N
SUBL	-	-	-	-	-
SUBR	-	-	-	-	-
X-Board	LJ92-01020A	9965 000 26192	LJ92-01268A	9965 000 32620	N
Y-Board	LJ92-01021A	9965 000 26193	LJ92-01149B	9965 000 32621	N
SMPS (PSU)	LJ44-00084A	9965 000 26194	LJ44-00084B	9965 000 32622	Y
SUB PSU	LJ44-00075A	9965 000 25131	LJ44-00075B	9965 000 32623	Y
			<b>Kit 1</b>	LJ93-00205A	9965 000 33796
			<b>Kit 2</b>	LJ93-00204A	9965 000 33797

### Note:

**Kit 1:** 37" FCR kit consists of 4 boards ( Logic + Y-main + Y and E buffer)

reference Symptom Cure information TV-05/0006

CORRECTION XI: PDP with "Lead" boards and use of Logic board (LJ92-01056A):

Replace the Logic board, the Y-Main board, the Y-buffer board, and the Logic buffer E board together.

These four boards are available in Service Kit number 1 (with order code 9965 000 33796 (LJ93-00205A)).

The content of Service Kit number 1 is:

- \* Logic main board 9965 000 29322 (LJ92-01257A).
- \* Y-Main board 9965 000 32621 (LJ92-01149B).
- \* Y-Buffer board 9965 000 32619 (LJ92-01147A).
- \* Logic-Buffer E 9965 000 32616 (LJ92-01138B).

### Note:

**FCR Kit:** = False contouring reduction kit

### Note:

**Kit 2:** 37" FCR kit consists of 2 boards (logic + Y-main)

reference Symptom Cure information TV-05/0006

CORRECTION XI

PDP with "Lead-free" boards and use of Logic board (LJ92-01145A):

Replace the Logic board and the Y-Main board together. These two boards are available in Service Kit number 2 (with order code 9965 000 33797 (LJ93-00204A)).

The content of Service Kit number 2 is:

- \* Logic main board 9965 000 29322 (LJ92-01257A).
- \* Y-Main board 9965 000 32621 (LJ92-01149B).

3) PDP with "Lead-free" boards and use of Logic board (LJ92-01257A):

In case this PDP has a defective board, replace this defective board only



Table 10-2 Spare parts overview 42" SD v2

PDP type	42"SDv2	
PDP model 12NC	9322 195 45682	
PDP model type and version	S42SD-YD06	
Remarks	Codes for lead type PWBs (this model has been produced with leaded type PWB's only)	
Boards	PWB Codes	
Logic-Buffer (E)	LJ92-00632A	9965 000 17726
Logic-Buffer (F)	LJ92-00633A	9965 000 17725
Logic-Buffer (G)	LJ92-00634A	9965 000 17724
Logic-Buffer (H)	-	-
Logic-Buffer (I)	-	-
Logic-Buffer (J)	-	-
Y-Buffer (up)	LJ92-00751A	9965 000 17727
Y-Buffer (down)	LJ92-00750A	9965 000 17728
Logic-Board	LJ92-00818A	9965 000 17729
SUBL	-	-
SUBR	-	-
X-Board	LJ92-00998A	9965 000 17720
Y-Board	LJ92-00999A	9965 000 17731
SMPS (PSU)	LJ44-00049A	9965 000 17730
SUB PSU	-	-

Table 10-3 Spare parts overview 42" SD v3

PDP type	42" SD v3				Lead Free type being compatible with Lead type PWB
PDP model 12NC	9322 215 27682				
PDP model type and version	S42SD-YD05				
Remarks	Lead type boards being phased out				
Boards	Codes for leaded type PWBs		Codes for lead-free type PWBs		
Logic-Buffer (E)	LJ92-00811A	9965 000 25109	LJ92-00811B	9965 000 32624	Y
Logic-Buffer (F)	LJ92-00812A	9965 000 25110	LJ92-00812B	9965 000 32625	Y
Logic-Buffer (G)	LJ92-00813A	9965 000 25111	LJ92-00813B	9965 000 32626	Y
Logic-Buffer (H)	-	-	-	-	-
Logic-Buffer (I)	-	-	-	-	-
Logic-Buffer (J)	-	-	-	-	-
Y-Buffer (up)	LJ92-00796A	9965 000 25112	LJ92-01285A	9965 000 32376	Y
Y-Buffer (down)	LJ92-00797A	9965 000 25113	LJ92-01286A	9965 000 32377	Y
Logic-Board	LJ92-00975D	9965 000 25114	LJ92-01247D	9965 000 32378	N (tdb)
SUBL	-	-	-	-	-
SUBR	-	-	-	-	-
X-Board	LJ92-00943A	9965 000 25115	LJ92-01283A	9965 000 32627	Y
Y-Board	LJ92-00944B	9965 000 25116	LJ92-01284A	9965 000 32379	Y
SMPS (PSU)	LJ44- 000 58A	9965 000 25108	LJ44-00058B	9965 000 32638	Y
SUB PSU	LJ44- 000 75A	9965 000 25131	LJ44-00075B	9965 000 32623	Y

Table 10-4 Spare parts overview 42" SD v4 (Part 1)

PDP type	42" SD v4				Boards from PP42SD015A and S42SD-YD07 (*) being compatible
PDP model 12NC	9322 226 37682				
PDP model type and version	S42SD-YD07 (*)		S42SD-YD07 (PP42SD015A)		
Remarks	No supply of new SMPS LJ44-00092B. Compatibility with LJ44-00101C + cable: tdb (15/2)		Version number used by SDI: PP42SD015B(SMPS Rev.0.55) New SMPS supply: LJ44-00101C + cables. Service information: tdb		
Logic-Buffer (E)	LJ92-01026A	9965 000 29205	LJ92-01026A	9965 000 29205	Y
Logic-Buffer (F)	LJ92-01027A	9965 000 29206	LJ92-01027A	9965 000 29206	Y
Logic-Buffer (G)	-	-	-	-	-
Logic-Buffer (H)	-	-	-	-	-
Logic-Buffer (I)	-	-	-	-	-
Logic-Buffer (J)	-	-	-	-	-
Y-Buffer (up)	LJ92-01031A	9965 000 29207	LJ92-01031A	9965 000 29207	Y
Y-Buffer (down)	LJ92-01032A	9965 000 29208	LJ92-01032A	9965 000 29208	Y
Logic-Board	LJ92-01274D	9966 000 30042	LJ92-01274D	9966 000 30042	Y
SUBL	-	-	-	-	-
SUBR	-	-	-	-	-
X-Board	LJ92-01029A	9965 000 29204	LJ92-01336A	9965 000 32628	Y
Y-Board	LJ92-01030A	9965 000 29209	LJ92-01337A	9965 000 32629	Y
SMPS (PSU)	LJ44-00092B	9965 000 29210	LJ44-00101A	9965 000 29210	N (tdb)
SUB PSU	-	-	-	-	-

Table 10-5 Spare parts overview 42" SD v4 (Part 2)

PDP type	42" SD v4					Service Information
PDP model 12NC	9322 226 96682			9322 233 81682		932223381682 being backwards compatible tbd
PDP model type and version	S42SD-YD07 (PP42SD015B)			S42SD-YD07 (PP42SD015F)		
Remarks	Version number used by SDI:PP42SD015B(SMPS Rev.0.55) New SMPS supply:LJ44-00101C + cables. Service information: tbd		PWB's from PP42SD015B and PP42SD015A being compatible	Version number used by SDI: PP42SD015F (SMPS Rev.0.7)		PWB's from PP42SD015B and PP42SD015F being compatible
Logic-Buffer (E)	LJ92-01026A	9965 000 29205	Y	LJ92-01026A	9965 000 29205	Y
Logic-Buffer (F)	LJ92-01027A	9965 000 29206	Y	LJ92-01027A	9965 000 29206	Y
Logic-Buffer (G)	-	-	-	-	-	-
Logic-Buffer (H)	-	-	-	-	-	-
Logic-Buffer (I)	-	-	-	-	-	-
Logic-Buffer (J)	-	-	-	-	-	-
Y-Buffer (up)	LJ92-01031A	9965 000 29207	Y	LJ92-01031A	9965 000 29207	Y
Y-Buffer (down)	LJ92-01032A	9965 000 29208	Y	LJ92-01032A	9965 000 29208	Y
Logic-Board	LJ92-01274D	9966 000 30042	Y	LJ92-01274D	9966 000 30042	Y
SUBL	-	-	-	-	-	-
SUBR	-	-	-	-	-	-
X-Board	LJ92-01336A	9965 000 32628	Y	LJ92-01336A	9965 000 32628	Y
Y-Board	LJ92-01337A	9965 000 32629	Y	LJ92-01337A	9965 000 32629	Y
SMPS (PSU)	LJ44-00101B	9965 000 32630	N	LJ44-00101C	9965 000 33880	Y
SUB PSU	-	-	-	-	-	-

Table 10-6 Spare parts overview 42" HD v3

PDP type	42" HD v3				Lead Free type being compatible with Lead type PWB
PDP model 12NC	9322 215 25682				
PDP model type and version	S42AX-XD02				
Remarks	Lead type boards being phased out		Codes for lead-free type PWBs		
Boards	Codes for leaded type PWBs		Codes for lead-free type PWBs		
Logic-Buffer (E)	LJ92-00895A	9965 000 25101	LJ92-01264A	9965 000 32631	Y
Logic-Buffer (F)	LJ92-00896A	9965 000 25102	LJ92-01265A	9965 000 32632	Y
Logic-Buffer (G)	-	-	-	-	-
Logic-Buffer (H)	-	-	-	-	-
Logic-Buffer (I)	-	-	-	-	-
Logic-Buffer (J)	-	-	-	-	-
Y-Buffer (up)	LJ92-00993A	9965 000 25103	LJ92-00993B	9965 000 32633	Y
Y-Buffer (down)	LJ92-00994A	9965 000 25104	LJ92-00994B	9965 000 32634	Y
Logic-Board	LJ92-00990E	9965 000 25105	LJ92-01221C	9965 000 32635	Y
SUBL	-	-	-	-	-
SUBR	-	-	-	-	-
X-Board	LJ92-00980A	9965 000 25106	LJ92-00980B	9965 000 32636	Y
Y-Board	LJ92-00981A	9965 000 25107	LJ92-00981B	9965 000 32637	Y
SMPS (PSU)	LJ44-00058A	9965 000 25108	LJ44-00058B	9965 000 32638	Y
SUB PSU	LJ44-00075A	9965 000 25131	LJ44-00075B	9965 000 32623	Y

Table 10-7 Spare parts overview 42" HD v4 (Part 1)

PDP type	42" HD v4				Boards from S42AX-YD01(*) and PP42AX- 007A being Compatible
PDP model 12NC	8204 000 78191		9322 225 38682		
PDP model type and version	S42AX-YD01 (*)		S42AX-YD01 (PP42AX-007A)		
Remarks	SMPS LJ44-00092A being phased out supply:LJ44-00101C + cables. Service information: tbd		(SMPS Rev.0.55) New SMPS supply:LJ44-00101C + cables. Service information: tbd		
Logic-Buffer (E)	LJ92-01054A	9965 000 29197	LJ92-01054A	9965 000 29197	Y
Logic-Buffer (F)	LJ92-01055A	9965 000 29198	LJ92-01055A	9965 000 29198	Y
Logic-Buffer (G)	-	-	-	-	-
Logic-Buffer (H)	-	-	-	-	-
Logic-Buffer (I)	-	-	-	-	-
Logic-Buffer (J)	-	-	-	-	-
Y-Buffer (up)	LJ92-01117A	9965 000 29199	LJ92-01202A	9965 000 32639	Y
Y-Buffer (down)	LJ92-01118A	9965 000 29200	LJ92-01203A	9965 000 32640	Y
Logic-Board	LJ92-01053A	9965 000 29203	LJ92-01270B	9965 000 32641	Y
SUBL	-	-	-	-	-
SUBR	-	-	-	-	-
X-Board	LJ92-01115A	9965 000 29196	LJ92-01199A	9965 000 32642	Y
Y-Board	LJ92-01200A	9965 000 32643	LJ92-01200A	9965 000 32643	Y
SMPS (PSU)	LJ44-00092A	9965 000 29202	LJ44-00101A	9965 000 29210	N
SUB PSU	-	-	-	-	-

Table 10-8 Spare parts overview 42" HD v4 (Part 2)

PDP type	42" HD v4					Service Information 9322 233 80682 being backwards compatible tbd
PDP model 12NC	9322 226 95682			9322 233 80682		
PDP model type and version	S42AX-YD01 (PP42AX-008A)		PWB's from PP42AX-007A and PP42AX-008A being Compatible	S42AX-YD01 (PP42AX-008B)		PWB's from PP42AX-008A and PP42AX-008B being compatible
Remarks	(SMPS Rev.0.65) New SMPS supply:LJ44-00101C + cables. Service information: tbd			(SMPS Rev.0.55) New SMPS supply:LJ44-00101C + cables. Service information: tbd		
Logic-Buffer (E)	LJ92-01054A	9965 000 29197	Y	LJ92-01054A	9965 000 29197	Y
Logic-Buffer (F)	LJ92-01055A	9965 000 29198	Y	LJ92-01055A	9965 000 29198	Y
Logic-Buffer (G)	-	-	-	-	-	-
Logic-Buffer (H)	-	-	-	-	-	-
Logic-Buffer (I)	-	-	-	-	-	-
Logic-Buffer (J)	-	-	-	-	-	-
Y-Buffer (up)	LJ92-01202A	9965 000 32639	Y	LJ92-01202A	9965 000 32639	Y
Y-Buffer (down)	LJ92-01203A	9965 000 32640	Y	LJ92-01203A	9965 000 32640	Y
Logic-Board	LJ92-01270B	9965 000 32641	Y	LJ92-01270B	9965 000 32641	Y
SUBL	-	-	-	-	-	-
SUBR	-	-	-	-	-	-
X-Board	LJ92-01199A	9965 000 32642	Y	LJ92-01199A	9965 000 32642	Y
Y-Board	LJ92-01200A	9965 000 32643	Y	LJ92-01200A	9965 000 32643	Y
SMPS (PSU)	LJ44-00101B	9965 000 32630	N	LJ44-00101C	9965 000 33880	Y
SUB PSU	-	-	-	-	-	-

Table 10-9 Spare parts overview 50" HD v3

PDP type	50" HD v3					
PDP model 12NC	9322 215 26682					
PDP model type and version	S50HW-XD03 (PP50HW004C)					
Remarks	Lead type boards being phased out					Lead Free type being compatible with Lead type PWB
Boards	Codes for leaded type PWBs		Codes for lead-free typePWBs			
Logic-Buffer (E)	LJ92-00917A	9965 000 25117	LJ92-00917B	9965 000 32614	Y	
Logic-Buffer (F)	LJ92-00918A	9965 000 25118	LJ92-00918B	9965 000 32615	Y	
Logic-Buffer (G)	LJ92-00919A	9965 000 25119	LJ92-00919B	9965 000 32646	Y	
Logic-Buffer (H)	LJ92-00920A	9965 000 25120	LJ92-00920B	9965 000 32647	Y	
Logic-Buffer (I)	LJ92-00921A	9965 000 25121	LJ92-00921B	9965 000 32648	Y	
Logic-Buffer (J)	LJ92-00922A	9965 000 25122	LJ92-00922B	9965 000 32649	Y	
Y-Buffer (up)	LJ92-00880A	9965 000 25123	LJ92-00880B	9965 000 32650	Y	
Y-Buffer (down)	LJ92-00881A	9965 000 25124	LJ92-00881B	9965 000 32651	Y	
Logic-Board	LJ92-00949C	9965 000 25125	LJ92-01224B	9965 000 32652	Y	
SUBL	LJ92-00923A	9965 000 25126	LJ92-00923B	9965 000 32653	Y	
SUBR	LJ92-00959A	9965 000 25127	LJ92-00959B	9965 000 32654	Y	
X-Board	LJ92-00852A	9965 000 25128	LJ92-00852B	9965 000 32655	Y	
Y-Board	LJ92-00853A	9965 000 25129	LJ92-00853B	9965 000 32656	Y	
SMPS (PSU)	LJ44-000 65A	9965 000 25130	LJ44-00065B	9965 000 32657	Y	
SUB PSU	LJ44-000 99A	9965 000 26195	LJ44-00099B	9965 000 32658	Y	

Table 10-10 Spare parts overview 50" HD v4 (Part 1)

PDP type	50" HD v4				
	9322 226 54682		9322 226 97682		
PDP model 12NC					
PDP model type and version	S50HW-XD04 (PP50HW-005A)		S50HW-XD04 (PP50HW-005B)		PWB's from PP50HW-005A and PP50HW-005B being compatible
Remarks	Codes for PWBs from 932222654682 PP50H-005A New SMPS supply:LJ44-00108C + cables. Service information: tbd		Codes for PWBs from 932222697682 PP50H-005B New SMPS supply:LJ44-00108C + cables. Service information: tbd		
Logic-Buffer (E)	LJ92-01103A	9965 000 30025	LJ92-01103A	9965 000 30025	Y
Logic-Buffer (F)	LJ92-01104A	9965 000 30026	LJ92-01104A	9965 000 30026	Y
Logic-Buffer (G)	LJ92-01105A	9965 000 30027	LJ92-01105A	9965 000 30027	Y
Logic-Buffer (H)	-	-	-	-	-
Logic-Buffer (I)	-	-	-	-	-
Logic-Buffer (J)	-	-	-	-	-
Y-Buffer (up)	LJ92-01047A	9965 000 30028	LJ92-01047A	9965 000 30028	Y
Y-Buffer (down)	LJ92-01048A	9965 000 30029	LJ92-01048A	9965 000 30029	Y
Logic-Board	LJ92-01269B	9965 000 30032	LJ92-01269B	9965 000 30032	Y
SUBL	-	-	-	-	-
SUBR	-	-	-	-	-
X-Board	LJ92-01045A	9965 000 30024	LJ92-01045A	9965 000 30024	Y
Y-Board	LJ92-01046A	9965 000 30030	LJ92-01046A	9965 000 30030	Y
SMPS (PSU)	LJ44-00108A	9965 000 33390	LJ44-00108B	9965 000 30031	N
SUB PSU	-	-	-	-	-

Table 10-11 Spare parts overview 50" HD v4 (Part 2)

PDP type	50" HD v4		Service information: 932223379682 being backwards compatible: tbd
	9322 233 79682		
PDP model 12NC			
PDP model type and version	S50HW-XD04 (PP50HW-005B)		PWB's from PP50HW-005B and PP50HW-005E being compatible
Remarks	Codes for PWBs from 932223379682 PP50H-005E		
Logic-Buffer (E)	LJ92-01103A	9965 000 30025	Y
Logic-Buffer (F)	LJ92-01104A	9965 000 30026	Y
Logic-Buffer (G)	LJ92-01105A	9965 000 30027	-
Logic-Buffer (H)	-	-	-
Logic-Buffer (I)	-	-	-
Logic-Buffer (J)	-	-	-
Y-Buffer (up)	LJ92-01047A	9965 000 30028	Y
Y-Buffer (down)	LJ92-01048A	9965 000 30029	Y
Logic-Board	LJ92-01269B	9965 000 30032	Y
SUBL	-	-	-
SUBR	-	-	-
X-Board	LJ92-01045A	9965 000 30024	Y
Y-Board	LJ92-01046A	9965 000 30030	Y
SMPS (PSU)	LJ44-00108C	9965 000 33879	Y
SUB PSU	-	-	-

**Note:** All 42- and 50-inch v4 panels are lead-free. Differences in table above are related to the SMPS (PSU).

# 11. Revision List

## Manual xxxx xxx xxxx.0

- First release.

## Manual xxxx xxx xxxx.1

- **General:** Update of whole manual to the latest publication standards and information.
- **37" SD v4:** Errors corrected, and info updated.
- **42" SD v2:** Errors corrected, and info updated.
- **42" SD v3:** Errors corrected, and info updated.
- **42" SD v4:** New.
- **42" HD v3:** Errors corrected, and info updated.
- **42" HD v4:** New.
- **50" HD v3:** Errors corrected, and info updated.
- **50" HD v4:** New.

## Manual xxxx xxx xxxx.2

- SMPS layouts and voltages updated
- Alignments updated
- Parts list updated

## Manual xxxx xxx xxxx.3

- **General:** Correction of some minor errors.
- **Chapter 8, Alignments:** Errors corrected, and info updated.