

Sx02xS Series

RoHS

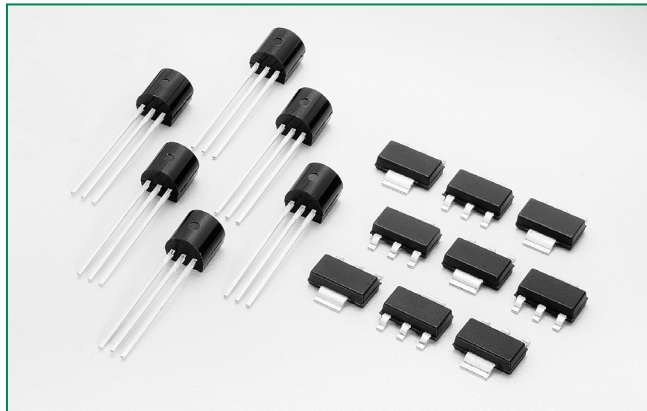

Main Features

| Symbol | Value | Unit |
|-------------------|------------|---------|
| $I_{T(RMS)}$ | 1.5 | A |
| V_{DRM}/V_{RRM} | 400 to 600 | V |
| I_{GT} | 200 | μ A |

Applications

The Sx02xS EV series is specifically designed for Gas Ignition applications that require high pulse surge current capability.

Description

New 1.5 Amp sensitive gate SCR series offers high static dv/dt with low turn off time (tq) through small die planar construction design. All SCR's junctions are glass-passivated to ensure long term reliability and parametric stability.

Features

- RoHS compliant and Halogen-Free
- Thru hole and surface mount packages
- Surge capability > 15Amps
- Blocking voltage (V_{DRM}/V_{RRM}) capability — up to 600V
- High dv/dt noise immunity
- Improved turn-off time (tq) < 35 μ sec.
- Sensitive gate for direct microprocessor interface

Schematic Symbol

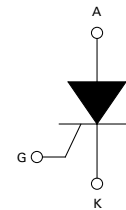

Absolute Maximum Ratings

| Symbol | Parameter | Value | Unit |
|--------------|--|--|-----------------------------|
| $I_{T(RMS)}$ | RMS on-state current (full sine wave) | TO-92 $T_c = 65^\circ\text{C}$ | 1.5 A |
| | | SOT-223 $T_L = 95^\circ\text{C}$ | |
| $I_{T(AV)}$ | Average on-state current | TO-92 $T_c = 65^\circ\text{C}$ | 0.95 A |
| | | SOT-223 $T_c = 95^\circ\text{C}$ | |
| I_{TSM} | Non repetitive surge peak on-state current (Single cycle, T_J initial = 25°C) | TO-92 $F = 50$ Hz | 12.5 A |
| | | SOT-223 $F = 60$ Hz | |
| I^2t | I^2t Value for fusing | $t_p = 10$ ms $F = 50$ Hz | 0.78 A^2s |
| | | $t_p = 8.3$ ms $F = 60$ Hz | |
| di/dt | Critical rate of rise of on-state current $I_G = 10\text{mA}$ | TO-92 $T_J = 125^\circ\text{C}$ SOT-223 | 50 $\text{A}/\mu\text{s}$ |
| I_{GM} | Peak gate current | $t_p = 10$ μs $T_J = 125^\circ\text{C}$ | 1.0 A |
| $P_{G(AV)}$ | Average gate power dissipation | $T_J = 125^\circ\text{C}$ | 0.1 W |
| T_{stg} | Storage junction temperature range | | -40 to 150 $^\circ\text{C}$ |
| T_J | Operating junction temperature range | | -40 to 125 $^\circ\text{C}$ |

Electrical Characteristics ($T_J = 25^\circ\text{C}$, unless otherwise specified)

| Symbol | Description | Test Conditions | Sx02xS | | Unit |
|-----------|--|--|--------|-----|------------------|
| | | | Min | Max | |
| I_{GT} | DC Gate Trigger Current | $V_D = 12\text{V}$ $R_L = 60\ \Omega$ | 15 | 200 | μA |
| V_{GT} | DC Gate Trigger Voltage | | — | 0.8 | V |
| V_{GRM} | Peak Reverse Gate Voltage | $I_{RG} = 10\ \mu\text{A}$ | 5 | — | V |
| I_H | Holding Current | $R_{GK} = 1\ \text{k}\Omega$ | — | 5 | mA |
| (dv/dt)s | Critical Rate-of-Rise of Off-State Voltage | $T_J = 125^\circ\text{C}$ $V_D = V_{DRM} / V_{RRM}$ Exponential Waveform $R_{GK} = 1\ \text{k}\Omega$ | 25 | — | V/ μs |
| t_q | Turn-Off Time | $T_J = 125^\circ\text{C} @ 600\ \text{V}$ $R_{GK} = 1\ \text{k}\Omega$ | — | 35 | μs |
| t_{gt} | Turn-On Time | $I_G = 10\ \text{mA}$ PW = 15 μsec $I_T = 3.0\ \text{A (pk)}$ | — | 3 | μs |

Static Characteristics ($T_J = 25^\circ\text{C}$, unless otherwise specified)

| Symbol | Description | Test Conditions | Value | | Unit |
|-----------|------------------------------------|---|-------|------|---------------|
| | | | Min | Max | |
| V_{TM} | Peak On-State Voltage | $I_{TM} = 3.0\ \text{A (pk)}$ | — | 1.70 | V |
| I_{DRM} | Off-State Current, Peak Repetitive | $T_J = 25^\circ\text{C} @ V_D = V_{DRM}$ $R_{GK} = 1\ \text{k}\Omega$ | — | 5 | μA |
| | | $T_J = 125^\circ\text{C} @ V_D = V_{DRM}$ $R_{GK} = 1\ \text{k}\Omega$ | — | 500 | μA |

Thermal Resistances

| Symbol | Parameter | | Value | Unit | |
|-------------------|-----------------------|---------------------------------|---------|------|--------------------|
| $R_{\theta(J-C)}$ | Junction to case (AC) | $I_T = 1.5\ \text{A}_{(RMS)}^1$ | TO-92 | 50 | $^\circ\text{C/W}$ |
| | | | SOT-223 | 25 | |
| $R_{\theta(J-A)}$ | Junction to ambient | $I_T = 1.5\ \text{A}_{(RMS)}^1$ | TO-92 | 160 | $^\circ\text{C/W}$ |
| | | | SOT-223 | 60 | |

¹ 60Hz AC resistive load condition, 100% conduction.

Additional Information

Datasheet

Resources

Samples

Figure 1: Normalized DC Gate Trigger Current vs. Junction Temperature

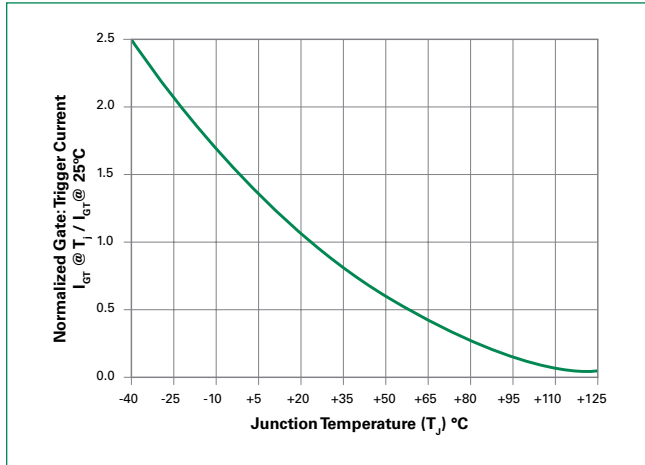

Figure 2: Normalized DC Holding Current vs. Junction Temperature

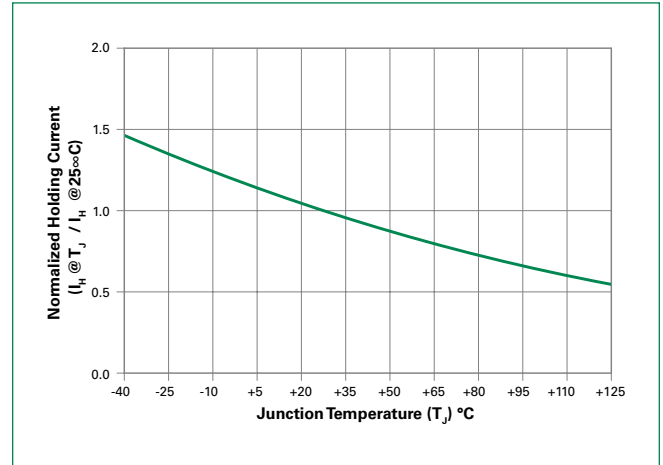

Figure 3: Normalized DC Gate Trigger Voltage vs. Junction Temperature

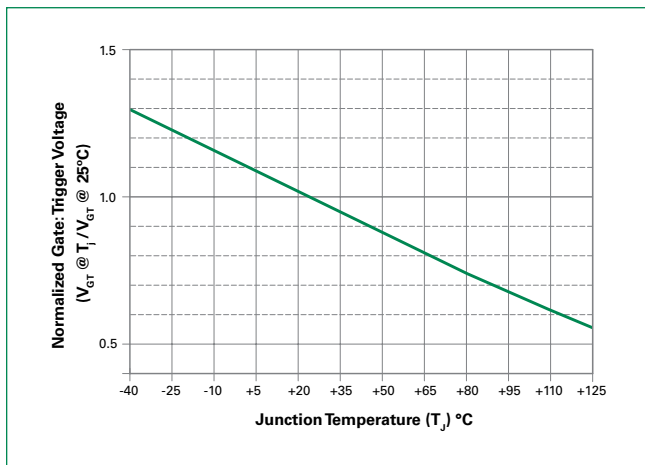

Figure 4: Power Dissipation (Typical) vs. RMS On-State Current

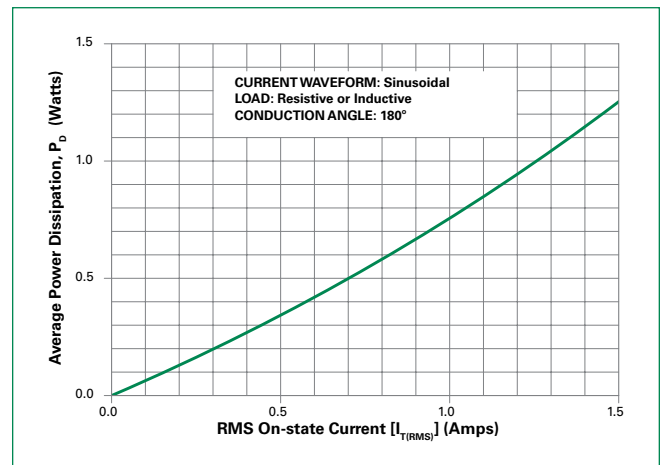

Figure 5: Maximum Allowable Case Temperature vs. On-State Current

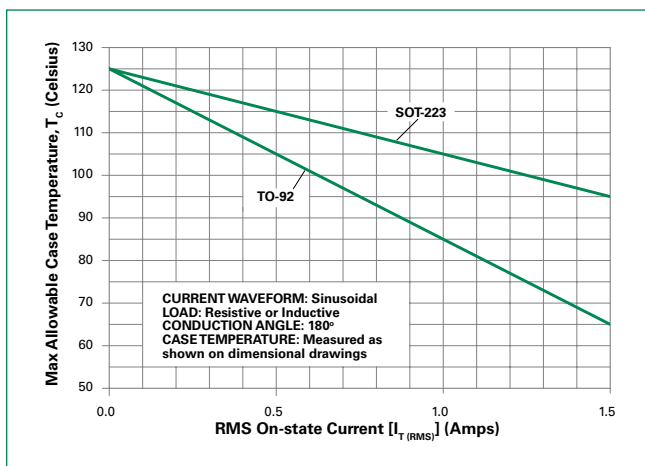
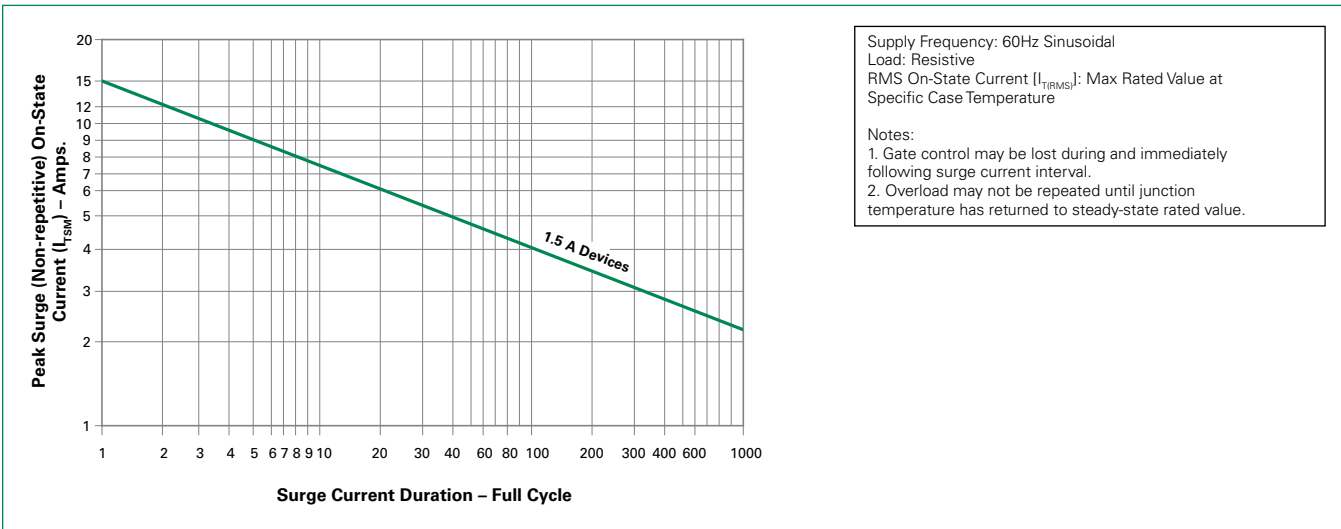
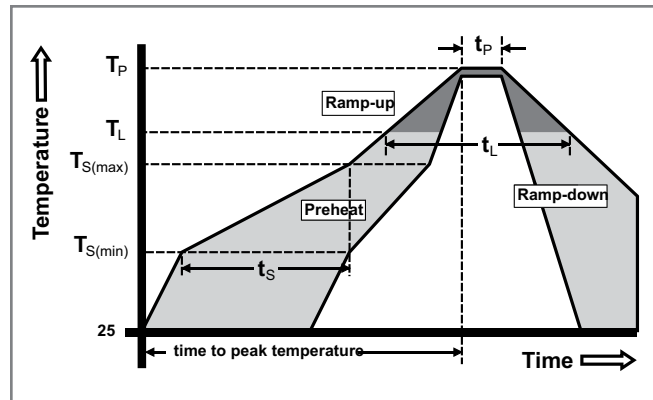

Figure 6: Surge Peak On-State Current vs. Number of Cycles



Soldering Parameters

| | | |
|--|------------------------------------|-------------------------|
| Reflow Condition | | Pb – Free assembly |
| Pre Heat | - Temperature Min ($T_{s(min)}$) | 150°C |
| | - Temperature Max ($T_{s(max)}$) | 200°C |
| | - Time (min to max) (t_s) | 60 – 180 secs |
| Average ramp up rate (Liquidus Temp) (T_L) to peak | | 5°C/second max |
| $T_{s(max)}$ to T_L - Ramp-up Rate | | 5°C/second max |
| Reflow | - Temperature (T_L) (Liquidus) | 217°C |
| | - Time (min to max) (t_s) | 60 – 150 seconds |
| Peak Temperature (T_p) | | 260 ^{+0/-5} °C |
| Time within 5°C of actual peak Temperature (t_p) | | 20 – 40 seconds |
| Ramp-down Rate | | 5°C/second max |
| Time 25°C to peak Temperature (T_p) | | 8 minutes Max. |
| Do not exceed | | 280°C |



Physical Specifications

| | |
|------------------------|--|
| Terminal Finish | 100% Matte Tin-plated. |
| Body Material | UL recognized epoxy meeting flammability classification 94V-0. |
| Lead Material | Copper Alloy |

Design Considerations

Careful selection of the correct device for the application's operating parameters and environment will go a long way toward extending the operating life of the Thyristor. Good design practice should limit the maximum continuous current through the main terminals to 75% of the device rating. Other ways to ensure long life for a power discrete semiconductor are proper heat sinking and selection of voltage ratings for worst case conditions. Overheating, overvoltage (including dv/dt), and surge currents are the main killers of semiconductors. Correct mounting, soldering, and forming of the leads also help protect against component damage.

Environmental Specifications

| Test | Specifications and Conditions |
|----------------------------------|---|
| AC Blocking | MIL-STD-750, M-1040, Cond A Applied Peak AC voltage @ 125°C for 1008 hours |
| Temperature Cycling | MIL-STD-750, M-1051, 100 cycles; -40°C to +150°C; 15-min dwell-time |
| Temperature/Humidity | EIA / JEDEC, JESD22-A101 1008 hours; 320V - DC: 85°C; 85% rel humidity |
| High Temp Storage | MIL-STD-750, M-1031, 1008 hours; 150°C |
| Low-Temp Storage | 1008 hours; -40°C |
| Thermal Shock | MIL-STD-750, M-1056 10 cycles; 0°C to 100°C; 5-min dwell-time at each temperature; 10 sec (max) transfer time between temperature |
| Autoclave | EIA / JEDEC, JESD22-A102 168 hours (121°C at 2 ATMs) and 100% R/H |
| Resistance to Solder Heat | MIL-STD-750 Method 2031 |
| Solderability | ANSI/J-STD-002, category 3, Test A |
| Lead Bend | MIL-STD-750, M-2036 Cond E |

Dimensions — TO-92 (E Package)

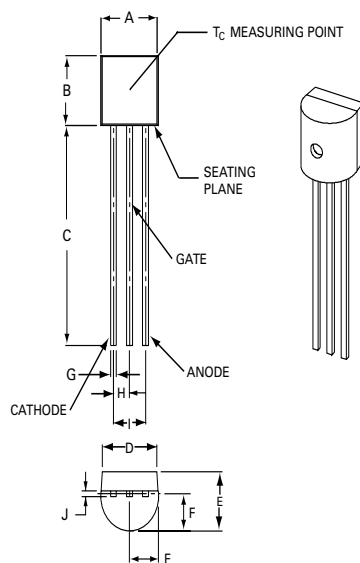

| Dimensions | Inches | | Millimeters | |
|------------|--------|-------|-------------|-------|
| | Min | Max | Min | Max |
| A | 0.175 | 0.205 | 4.450 | 5.200 |
| B | 0.170 | 0.210 | 4.320 | 5.330 |
| C | 0.500 | — | 12.700 | — |
| D | 0.135 | — | 3.430 | — |
| E | 0.125 | 0.165 | 3.180 | 4.190 |
| F | 0.080 | 0.105 | 2.040 | 2.660 |
| G | 0.016 | 0.021 | 0.407 | 0.533 |
| H | 0.045 | 0.055 | 1.150 | 1.390 |
| I | 0.095 | 0.105 | 2.420 | 2.660 |
| J | 0.015 | 0.020 | 0.380 | 0.500 |

Dimensions – SOT-223

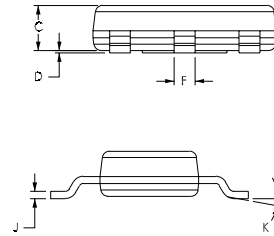
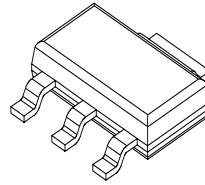
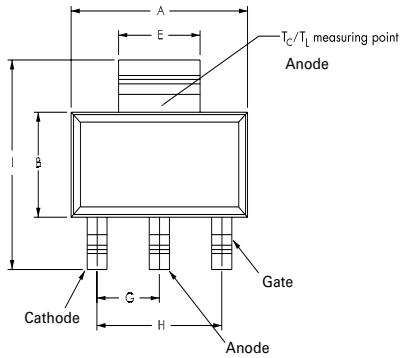

Pad Layout for SOT-223

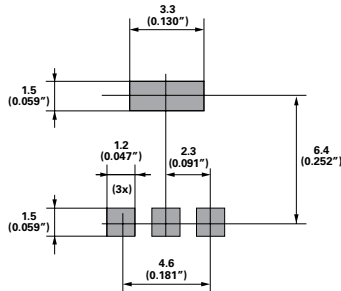

Dimensions in Millimeters (Inches)

| Dimensions | Inches | | | Millimeters | | |
|------------|---------|-------|-------|-------------|------|------|
| | Min | Typ | Max | Min | Typ | Max |
| A | 0.248 | 0.256 | 0.264 | 6.30 | 6.50 | 6.70 |
| B | 0.130 | 0.138 | 0.146 | 3.30 | 3.50 | 3.70 |
| C | — | — | 0.071 | — | — | 1.80 |
| D | 0.001 | — | 0.004 | 0.02 | — | 0.10 |
| E | 0.114 | 0.118 | 0.124 | 2.90 | 3.00 | 3.15 |
| F | 0.024 | 0.027 | 0.034 | 0.60 | 0.70 | 0.85 |
| G | — | 0.090 | — | — | 2.30 | — |
| H | — | 0.181 | — | — | 4.60 | — |
| I | 0.264 | 0.276 | 0.287 | 6.70 | 7.00 | 7.30 |
| J | 0.009 | 0.010 | 0.014 | 0.24 | 0.26 | 0.35 |
| K | 10° MAX | | | | | |

Product Selector

| Part Number | Voltage | | Gate Sensitivity | Package |
|-------------|---------|------|------------------|---------|
| | 400V | 600V | | |
| S402ES | X | — | 200µA | TO-92 |
| S602ES | — | X | 200µA | TO-92 |
| S402TS | X | — | 200µA | SOT-223 |
| S602TS | — | X | 200µA | SOT-223 |

Packing Options

| Part Number | Marking | Weight | Packing Mode | Base Quantity |
|-------------|---------|---------|--------------|---------------|
| Sx02ES | Sx02ES | 0.170 g | Bulk | 2500 |
| Sx02ESAP | Sx02ES | 0.170 g | Ammo Pack | 2000 |
| Sx02ESRP | Sx02ES | 0.170 g | Tape & Reel | 2000 |
| Sx02TSRP | Sx02TS | 0.120 g | Tape & Reel | 1000 |

Note: x = voltage

TO-92 (3-lead) Reel Pack (RP) Radial Leaded Specifications

Meets all EIA-468-C Standards

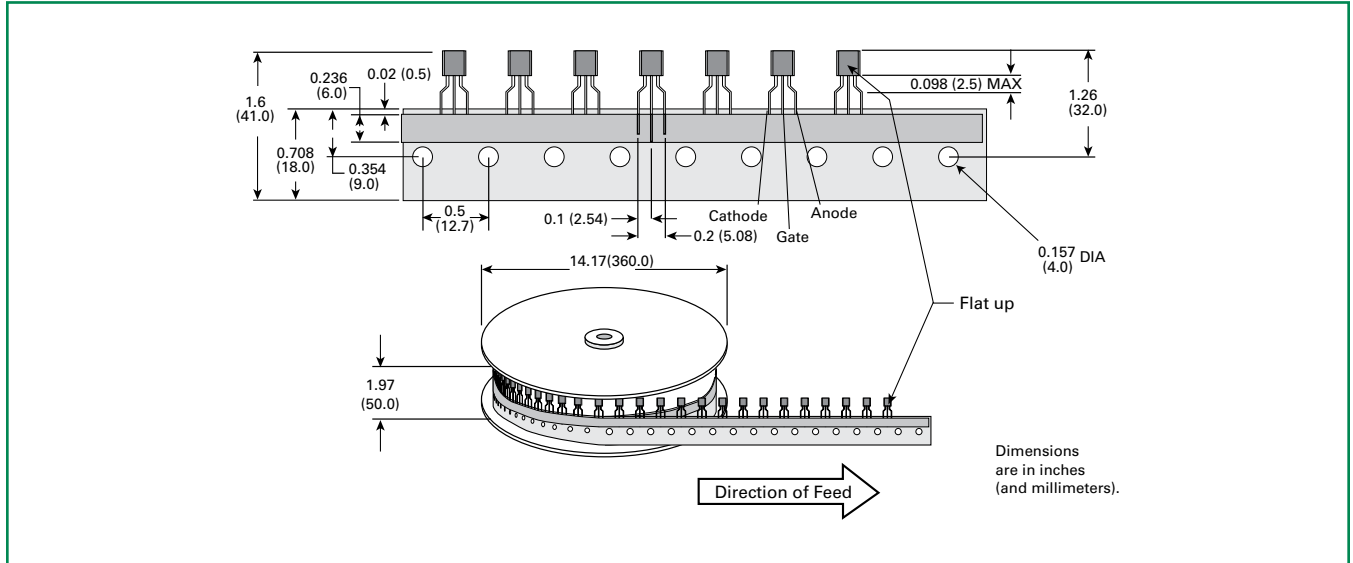

TO-92 (3-lead) Ammo Pack (AP) Radial Leaded Specifications

Meets all EIA-468-C Standards

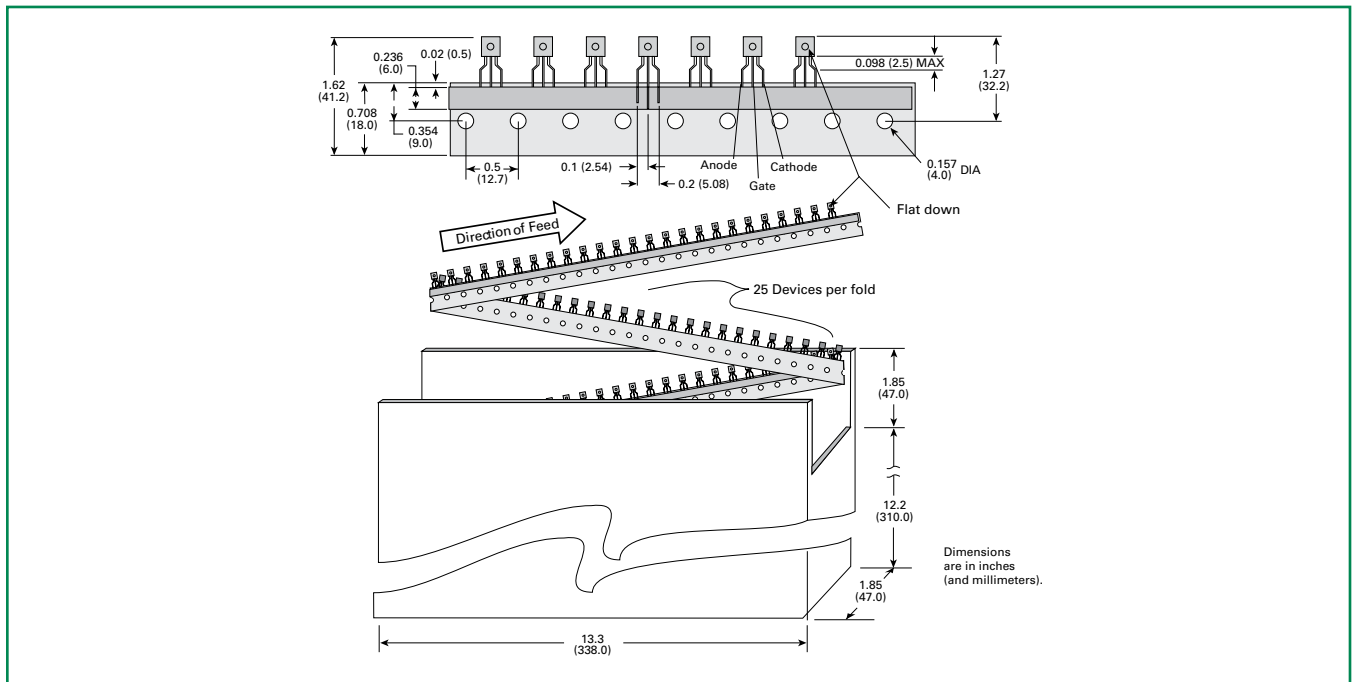

SOT-223 Reel Pack (RP) Specifications

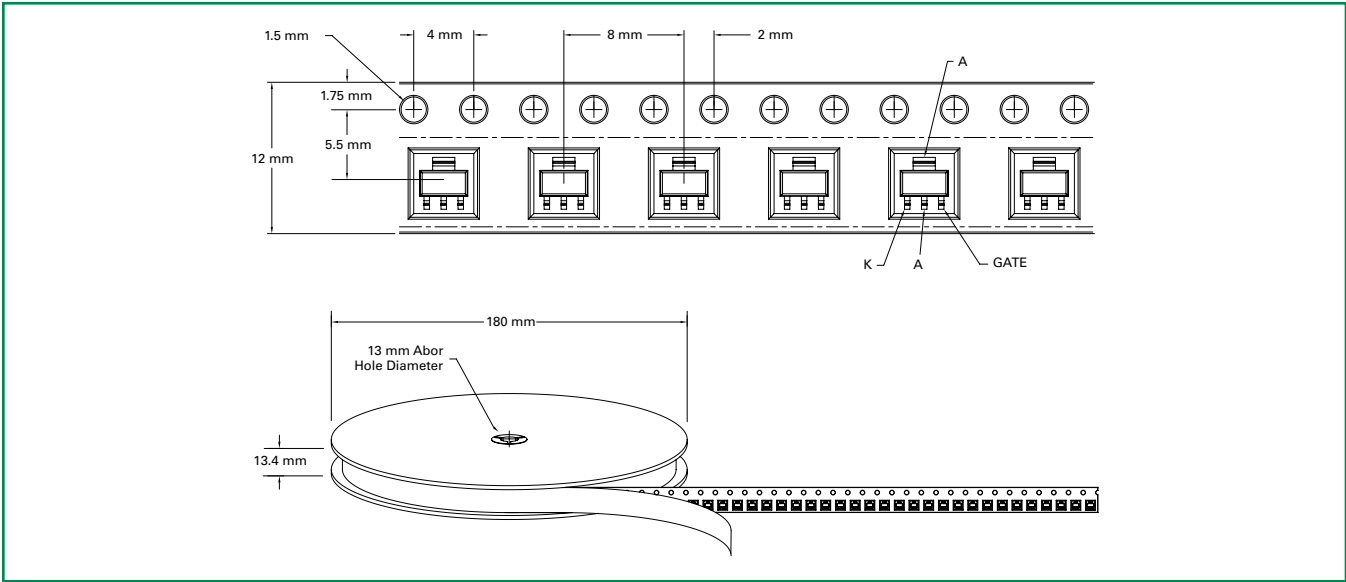

Part Numbering System

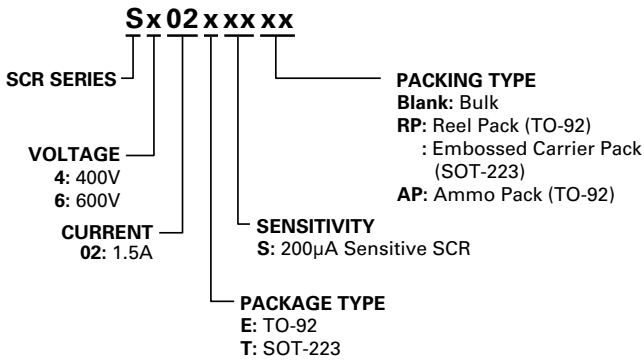

Part Marking System

