



S486

CMOS IC

DUAL 100mW AUDIO POWER AMPLIFIER WITH STANDBY MODE

DESCRIPTION

The UTC **S486** is a dual power amplifier capable of delivering typically 100mW per channel of continuous average power to an 8Ω load with 0.1% THD+N using a 5V power supply.

The UTC **S486** features an externally controlled, low-power consumption stand by mode. The UTC **S486** exhibit a low quiescent current of typically 1.8mA, allowing usage in portable applications.

The unity-gain stable UTC **S486** can be configured by external gain-setting resistors.

FEATURES

- * Operating voltage range $V_{CC}=2V \sim 5.5V$
- * Output power:
 - 102mW @5V into 16Ω with 0.1% THD+N max (1kHz)
- * Stand by mode available
- * Low current consumption: 2.5mA max
- * Click and pop reduction circuitry
- * Unity-gain stable
- * Short circuit protected

ORDERING INFORMATION

Ordering Number		Package	Packing
Lead Free	Halogen Free		
S486L-S08-R	S486G-S08-R	SOP-8	Tape Reel
S486L-SM1-R	S486G-SM1-R	MSOP-8	Tape Reel

<p>S486G-S08-R</p> <ul style="list-style-type: none"> (1) Packing Type (2) Package Type (3) Green Package 	<ul style="list-style-type: none"> (1) R: Tape Reel (2) S08: SOP-8, SM1: MSOP-8 (3) G: Halogen Free and Lead Free, L: Lead Free
--	--

MARKING

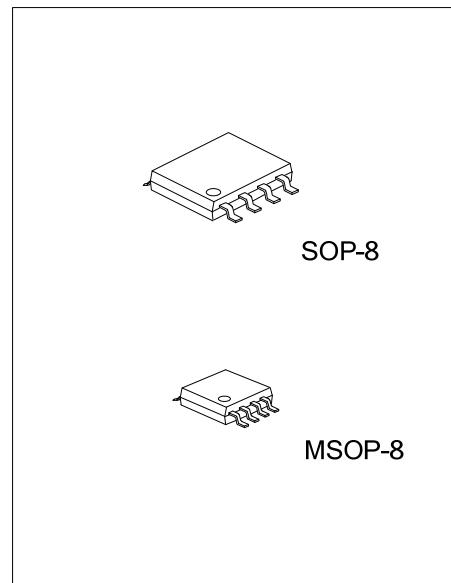
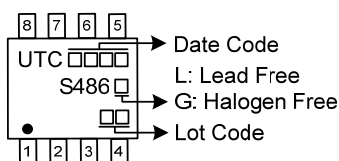

■ PIN CONFIGURATION

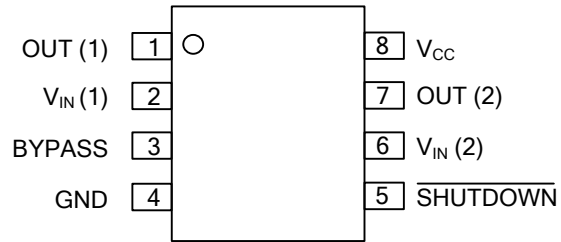

■ ABSOLUTE MAXIMUM RATING (T_A=25°C)

PARAMETER	SYMBOL	RATINGS	UNIT
Supply voltage (Note 2)	V _{CC}	6	V
Input Voltage	V _{IN}	-0.3V ~ V _{CC} +0.3V	V
Output Short Circuit to V _{CC} or GND		Continuous(Note 3)	
Power Dissipation (T _J =150°C)	SOP-8	0.71	W
	MSOP-8	0.58	W
Junction Temperature	T _J	+150	°C
Operating Temperature	T _{OPR}	-40 ~ +85	°C
Storage Temperature	T _{STG}	-65 ~ +150	°C

Notes: 1. Absolute maximum ratings are those values beyond which the device could be permanently damaged.

Absolute maximum ratings are stress ratings only and functional device operation is not implied.

2. All voltage values are measured with respect to the ground pin.

3. Attention must be paid to continuous power dissipation (V_{DD} × 300mA). Exposure of the I_C to a short circuit for an extended time period is dramatically reducing product life expectancy.

■ THERMAL DATA

PARAMETER	SYMBOL	RATINGS	UNIT
Junction to Ambient	SOP-8	175	°C/W
	MSOP-8	215	°C/W

■ RECOMMENDED OPERATING CONDITIONS

PARAMETER	SYMBOL	RATINGS	UNIT
Supply Voltage	V _{CC}	2 ~ 5.5	V
Standby Voltage Input	ACTIVE	1.5 ≤ V _{STB} ≤ V _{CC}	V
	STANDBY	GND ≤ V _{STB} ≤ 0.4(Note)	V
Load Resistor	R _L	≥ 16	Ω
Load Capacitor	R _L = 16 ~ 100Ω	400	pF
	R _L > 100Ω	100	pF
Junction to Ambient	θ _{JA}	150	°C/W

Note: The minimum current consumption (I_{STB}) is guaranteed at GND for the whole temperature range.

■ ELECTRICAL CHARACTERISTICS ($T_A = 25^\circ\text{C}$, GND = 0V, unless otherwise specified)

For $V_{CC} = +5\text{V}$

PARAMETER	SYMBOL	TEST CONDITIONS	MIN	TYP	MAX	UNIT	
Output Swing	V_{OUT}	V_{OL} : $R_L=32\Omega$		0.45	0.5	V	
		V_{OH} : $R_L=32\Omega$	4.45	4.52			
		V_{OL} : $R_L=16\Omega$		0.6	0.7		
		V_{OH} : $R_L=16\Omega$	4.2	4.35			
Input Offset Voltage	$V_{I(OFF)}$	$V_{ICM}=V_{CC}/2$		1		mV	
Supply Current	I_{CC}	Noinputsignal, noload		1.8	2.5	mA	
Stand By Current	I_{STB}	Noinputsignal, $V_{STB}=\text{GND}$, $R_L=32\Omega$		10	1000	nA	
Input Bias Current	$I_{I(BIAS)}$	$V_{ICM}=V_{CC}/2$		90	200	nA	
Max Output Current	I_{OUT}	THD+N \leq 1%, $R_L=16\Omega$ connectedbetweenoutand $V_{CC}/2$	106	115		mA	
Output Power	P_{OUT}	THD+N=0.1% Max, F=1kHz	$R_L=16\Omega$		102		mW
			$R_L=32\Omega$		64		
		THD+N=1% Max, F=1kHz	$R_L=16\Omega$	95	108		
			$R_L=32\Omega$	60	65		
Total Harmonic Distortion + Noise ($G_V=-1$)	THD+N	$R_L=32\Omega$, $P_{OUT}=60\text{mW}$, $20\text{Hz}\leq F\leq 20\text{kHz}$		0.3		%	
		$R_L=16\Omega$, $P_{OUT}=90\text{mW}$, $20\text{Hz}\leq F\leq 20\text{kHz}$		0.3			
Power Supply Rejection Ratio	PSRR	inputsgrounded ($G_V=-1$)(Note), $R_L\geq 16\Omega$, $C_B=1\text{mF}$, F=1kHz, $V_{RIPPLE}=200\text{mV}_{PP}$	53	58		dB	
Signal-to-Noise Ratio	SNR	(Aweighted, $G_V=-1$)(Note), $R_L=32\Omega$, THD+N<0.4%, $20\text{Hz}\leq F\leq 20\text{kHz}$	80	103		dB	
Crosstalk	CT	ChannelSeparation, $G_V=-1$, F=1kHz	$R_L=16\Omega$		80		dB
			$R_L=32\Omega$		83		
		ChannelSeparation, $G_V=-1$, F=20Hz~20kHz	$R_L=16\Omega$		72		
			$R_L=32\Omega$		79		
Input Capacitance	C_{IN}			1		pF	
Gain Bandwidth Product	GB_W	$R_L=32\Omega$		1.1		MHz	
Slew Rate	SR	UnityGainInverting ($R_L=16\Omega$)		0.4		V/ μs	

Note: Guaranteed by design and evaluation.

■ ELECTRICAL CHARACTERISTICS(Cont.) ($T_A = 25^\circ\text{C}$, GND = 0V, unless otherwise specified)

For $V_{CC} = +3.3\text{V}$

PARAMETER	SYMBOL	TEST CONDITIONS	MIN	TYP	MAX	UNIT	
Output Swing	V_{OUT}	$V_{OL}: R_L=32\Omega$		0.3	0.38	V	
		$V_{OH}: R_L=32\Omega$	2.85	3			
		$V_{OL}: R_L=16\Omega$		0.45	0.52		
		$V_{OH}: R_L=16\Omega$	2.68	2.85			
Input Offset Voltage	$V_{I(OFF)}$	$V_{ICM}=V_{CC}/2$		1		mV	
Supply Current	I_{CC}	Noinputsignal, noload		1.8	2.5	mA	
Stand By Current	I_{STB}	Noinputsignal, $V_{STB}=\text{GND}$, $R_L=32\Omega$		10	1000	nA	
Input Bias Current	$I_{I(BIAS)}$	$V_{ICM}=V_{CC}/2$		90	200	nA	
Max Output Current	I_{OUT}	THD+N \leq 1%, $R_L=16\Omega$ connectedbetweenoutand $V_{CC}/2$	64	75		mA	
Output Power	P_{OUT}	THD+N=0.1% Max, F=1kHz	$R_L=16\Omega$		38		mW
			$R_L=32\Omega$		26		
		THD+N=1% Max, F=1kHz	$R_L=16\Omega$	36	42		
			$R_L=32\Omega$	23	28		
Total Harmonic Distortion + Noise ($G_V=-1$)	THD+N	$R_L=32\Omega$, $P_{OUT}=60\text{mW}$, $20\text{Hz}\leq F\leq 20\text{kHz}$		0.3		%	
		$R_L=16\Omega$, $P_{OUT}=90\text{mW}$, $20\text{Hz}\leq F\leq 20\text{kHz}$		0.3			
Power Supply Rejection Ratio	PSRR	inputsgrounded($G_V=-1$)(Note2), $R_L\geq 16\Omega$, $C_B=1\text{mF}$, F=1kHz, $V_{RIPPLE}=200\text{mV}_{PP}$	53	58		dB	
Signal-to-Noise Ratio	SNR	(Aweighted, $G_V=-1$)(Note2), $R_L=32\Omega$, THD+N $<$ 0.4%, $20\text{Hz}\leq F\leq 20\text{kHz}$	80	98		dB	
Crosstalk	CT	ChannelSeparation, $G_V=-1$, F=1kHz	$R_L=16\Omega$		77		dB
			$R_L=32\Omega$		80		
		ChannelSeparation, $G_V=-1$, F=20Hz~20kHz	$R_L=16\Omega$		69		
			$R_L=32\Omega$		76		
Input Capacitance	C_{IN}			1		pF	
Gain Bandwidth Product	GBW	$R_L=32\Omega$		1.1		MHz	
Slew Rate	SR	UnityGainInverting ($R_L=16\Omega$)		0.4		V/ μs	

Note 1. All electrical values are guaranteed with correlation measurements at 2V and 5V.

2. Guaranteed by design and evaluation.

■ ELECTRICAL CHARACTERISTICS(Cont.) ($T_A = 25^\circ\text{C}$, GND = 0V, unless otherwise specified)

For $V_{CC} = +2.5\text{V}$

PARAMETER	SYMBOL	TEST CONDITIONS	MIN	TYP	MAX	UNIT
Output Swing	V_{OUT}	$V_{OL}: R_L=32\Omega$		0.25	0.32	V
		$V_{OH}: R_L=32\Omega$	2.14	2.25		
		$V_{OL}: R_L=16\Omega$		0.35	0.45	
		$V_{OH}: R_L=16\Omega$	1.97	2.15		
Input Offset Voltage	$V_{I(OFF)}$	$V_{ICM}=V_{CC}/2$		1		mV
Supply Current	I_{CC}	Noinputsignal, noload		1.7	2.5	mA
Stand By Current	I_{STB}	Noinputsignal, $V_{STB}=GND$, $R_L=32\Omega$		10	1000	nA
Input Bias Current	$I_{I(BIAS)}$	$V_{ICM}=V_{CC}/2$		90	200	nA
Max Output Current	I_{OUT}	THD+N \leq 1%, $R_L=16\Omega$ connectedbetweenoutand $V_{CC}/2$	45	56		mA
Output Power	P_{OUT}	THD+N=0.1% Max, F=1kHz	$R_L=16\Omega$		21	mW
			$R_L=32\Omega$		13	
		THD+N=1% Max, F=1kHz	$R_L=16\Omega$	17.5	22	
			$R_L=32\Omega$	12.5	14	
Total Harmonic Distortion + Noise ($G_V=-1$)	THD+N	$R_L=32\Omega$, $P_{OUT}=60\text{mW}$, $20\text{Hz}\leq F\leq 20\text{kHz}$		0.3		%
		$R_L=16\Omega$, $P_{OUT}=90\text{mW}$, $20\text{Hz}\leq F\leq 20\text{kHz}$		0.3		
Power Supply Rejection Ratio	PSRR	inputsgrounded($G_V=-1$)(Note2), $R_L\geq 16\Omega$, $C_B=1\text{mF}$, F=1kHz, $V_{RIPPLE}=200\text{mV}_{PP}$	53	58		dB
Signal-to-Noise Ratio	SNR	(Aweighted, $A_V=-1$)(Note2), $R_L=32\Omega$, THD+N<0.4%, $20\text{Hz}\leq F\leq 20\text{kHz}$	80	95		dB
Crosstalk	CT	ChannelSeparation, $G_V=-1$, F=1kHz	$R_L=16\Omega$		77	dB
			$R_L=32\Omega$		80	
		ChannelSeparation, $G_V=-1$, F=20Hz~20kHz	$R_L=16\Omega$		69	
			$R_L=32\Omega$		76	
Input Capacitance	C_{IN}			1		pF
Gain Bandwidth Product	GBP	$R_L=32\Omega$		1.1		MHz
Slew Rate	SR	UnityGainInverting ($R_L=16\Omega$)		0.4		V/ μs

Note 1. All electrical values are guaranteed with correlation measurements at 2V and 5V.

2. Guaranteed by design and evaluation.

■ ELECTRICAL CHARACTERIST(Cont.) ($T_A = 25^\circ\text{C}$, GND = 0V, unless otherwise specified)

For $V_{CC} = +2\text{V}$

PARAMETER	SYMBOL	TEST CONDITIONS	MIN	TYP	MAX	UNIT	
Output Swing	V_{OUT}	$V_{OL}:R_L=32\Omega$		0.24	0.29	V	
		$V_{OH}:R_L=32\Omega$	1.67	1.73			
		$V_{OL}:R_L=16\Omega$		0.33	0.41		
		$V_{OH}:R_L=16\Omega$	1.53	1.63			
Input Offset Voltage	$V_{I(OFF)}$	$V_{ICM}=V_{CC}/2$		1		mV	
Supply Current	I_{CC}	Noinputsignal, noload		1.7	2.5	mA	
Stand By Current	I_{STB}	Noinputsignal, $V_{STB}=\text{GND}$, $R_L=32\Omega$		10	1000	nA	
Input Bias Current	$I_{I(BIAS)}$	$V_{ICM}=V_{CC}/2$		90	200	nA	
Max Output Current	I_{OUT}	THD+N \leq 1%, $R_L=16\Omega$ connectedbetweenoutand $V_{CC}/2$	33	41		mA	
Output Power	P_{OUT}	THD+N=0.1% Max, F=1kHz	$R_L=16\Omega$		12		mW
			$R_L=32\Omega$		8		
		THD+N=1% Max, F=1kHz	$R_L=16\Omega$	9.5	13		
			$R_L=32\Omega$	7	9		
Total Harmonic Distortion + Noise ($G_V=-1$)	THD+N	$R_L=32\Omega$, $P_{OUT}=60\text{mW}$, $20\text{Hz}\leq F\leq 20\text{kHz}$		0.3		%	
		$R_L=16\Omega$, $P_{OUT}=90\text{mW}$, $20\text{Hz}\leq F\leq 20\text{kHz}$		0.3			
Power Supply Rejection Ratio	PSRR	inputsgrounded ($G_V=-1$)(Note), $R_L\geq 16\Omega$, $C_B=1\text{mF}$, F=1kHz, $V_{RIPPLE}=200\text{mV}_{PP}$	52	57		dB	
Signal-to-Noise Ratio	SNR	(Aweighted, $G_V=-1$)(Note), $R_L=32\Omega$, THD+N $<$ 0.4%, $20\text{Hz}\leq F\leq 20\text{kHz}$	80	93		dB	
Crosstalk	CT	ChannelSeparation, $G_V=-1$, F=1kHz	$R_L=16\Omega$		77		dB
			$R_L=32\Omega$		80		
		ChannelSeparation, $G_V=-1$, F=20Hz~20kHz	$R_L=16\Omega$		69		
			$R_L=32\Omega$		76		
Input Capacitance	C_{IN}			1		pF	
Gain Bandwidth Product	GBP	$R_L=32\Omega$		1.1		MHz	
Slew Rate	SR	UnityGainInverting ($R_L=16\Omega$)		0.4		V/ μs	

Note: Guaranteed by design and evaluation.

TYPICAL APPLICATION CIRCUIT

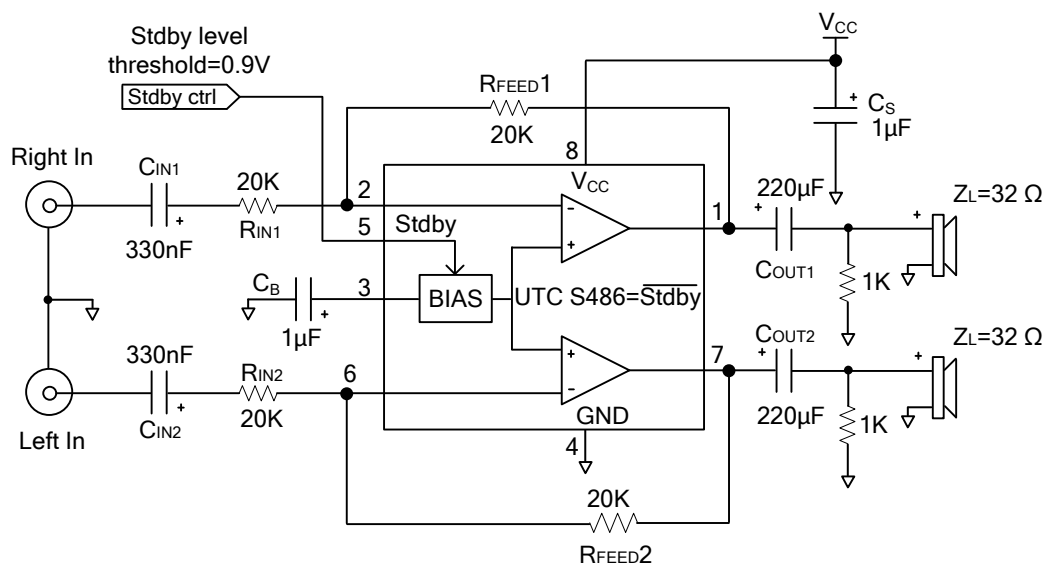

COMPONENTS INFORMATION

Components	Functional Description
$R_{IN1,2}$	Inverting input resistor which sets the closed loop gain in conjunction with R_{FEED} . This resistor also forms a high pass filter with C_{IN} ($f_c = 1 / (2 \times \pi \times R_{IN} \times C_{IN})$).
$C_{IN1,2}$	Input coupling capacitor which blocks the DC voltage at the amplifier's input terminal.
$R_{FEED1,2}$	Feedback resistor which sets the closed loop gain in conjunction with R_{IN} . $A_V = \text{Closed Loop Gain} = -R_{FEED}/R_{IN}$.
C_S	Supply Bypass capacitor which provides power supply filtering.
C_B	Bypass capacitor which provides half supply filtering.
$C_{OUT1,2}$	Output coupling capacitor which blocks the DC voltage at the load input terminal. This capacitor also forms a high pass filter with R_L ($f_c = 1 / (2 \times \pi \times R_L \times C_{OUT})$).

■ TYPICAL CHARACTERISTICS

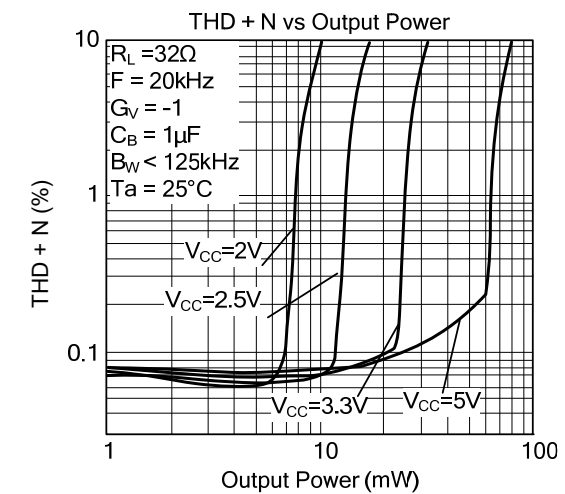
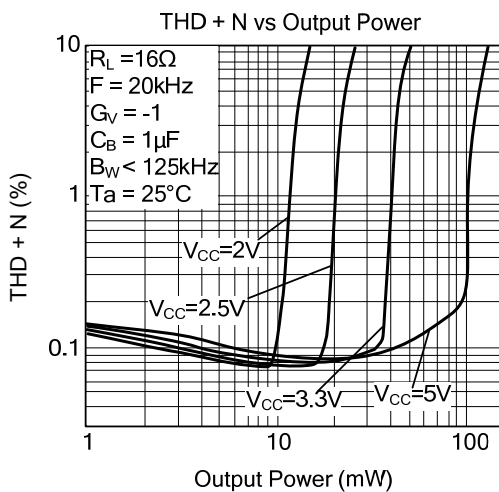
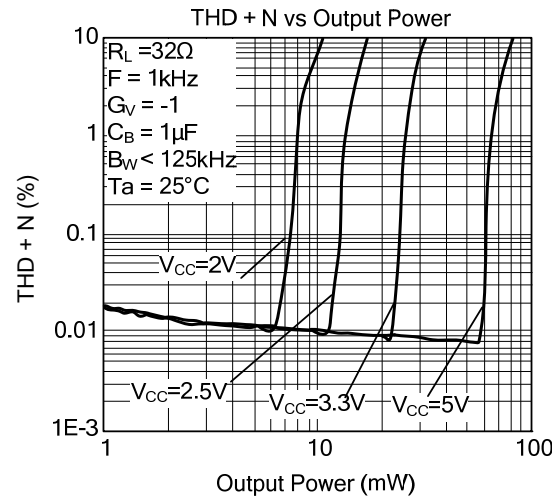
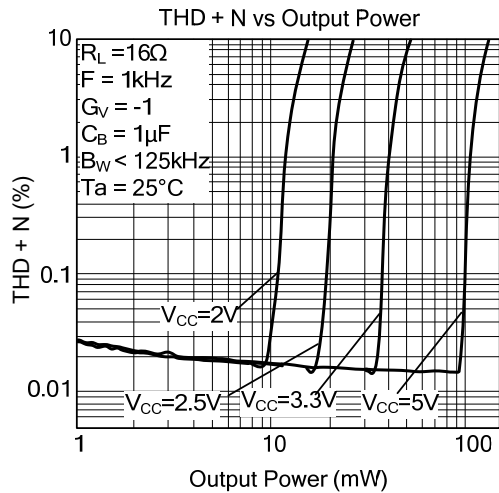
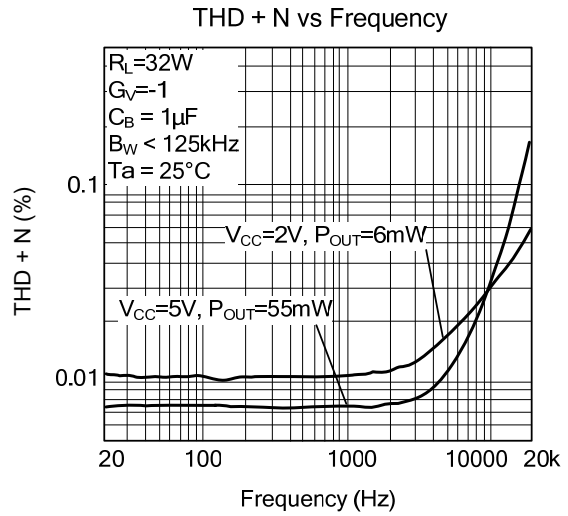
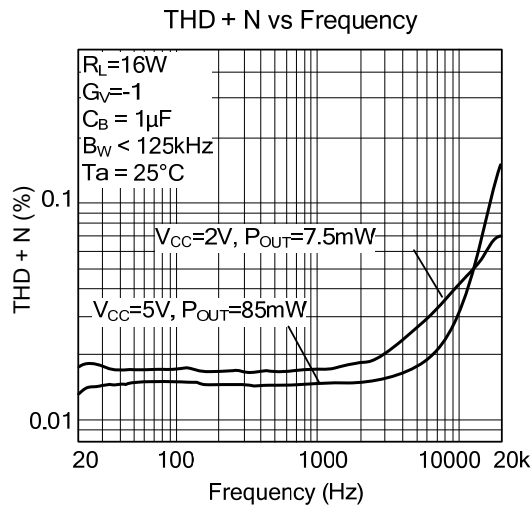

■ TYPICAL CHARACTERISTICS(Cont.)

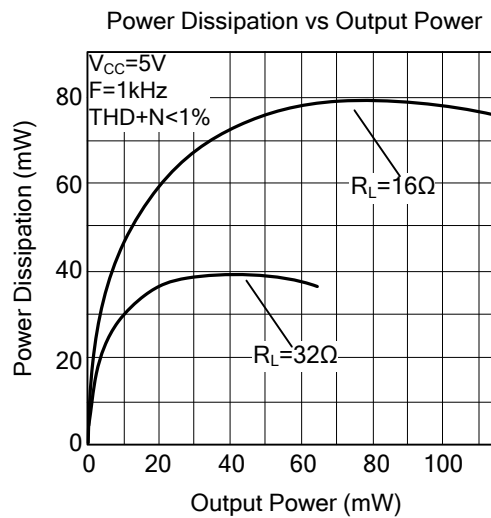
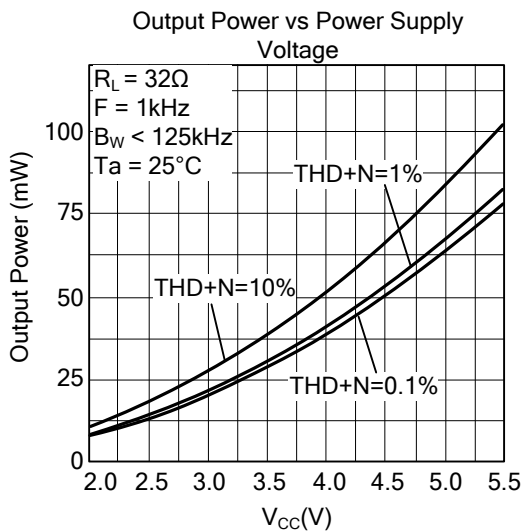
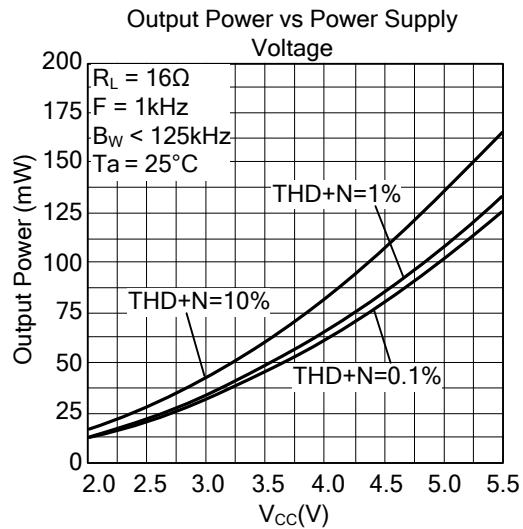
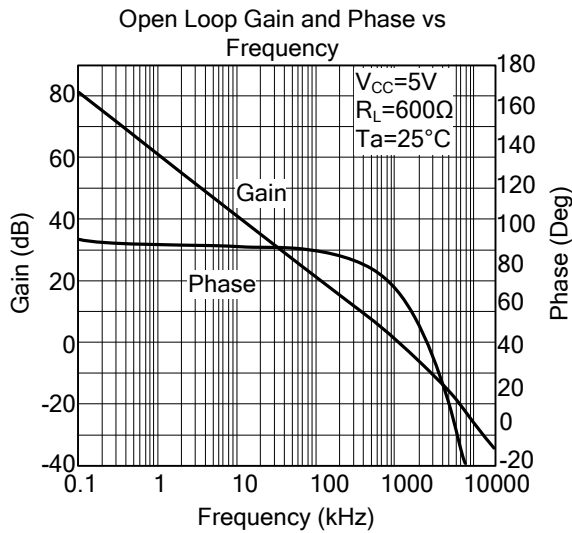
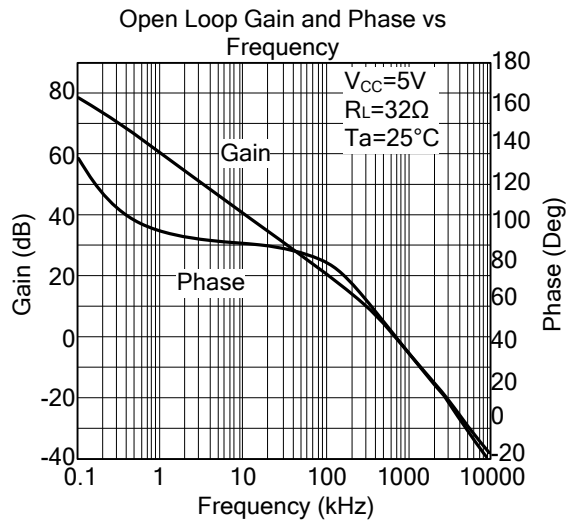
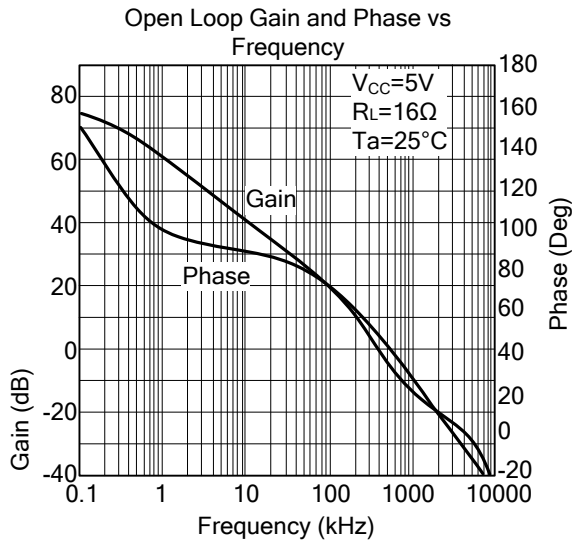

■ TYPICAL CHARACTERISTICS(Cont.)

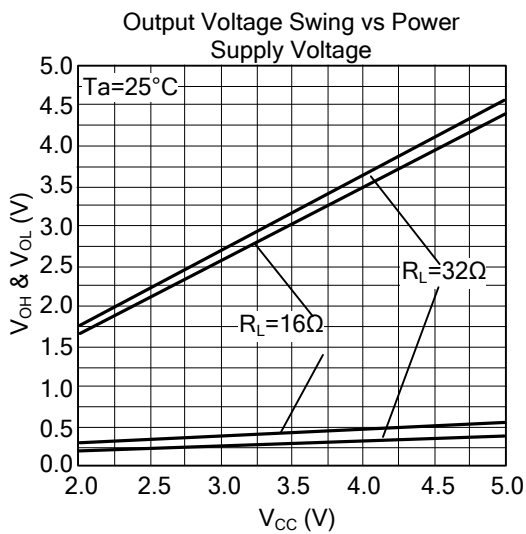
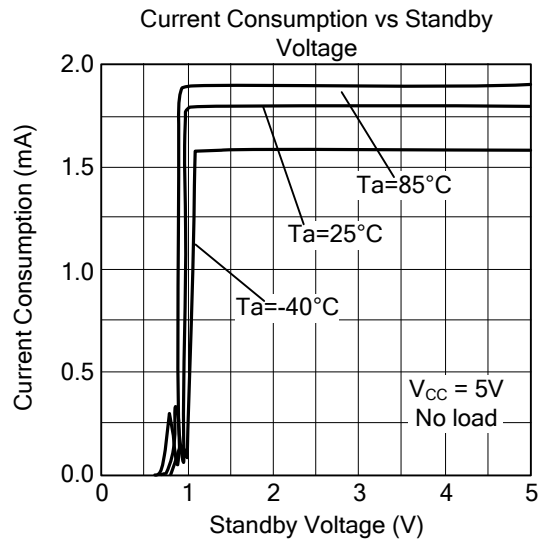
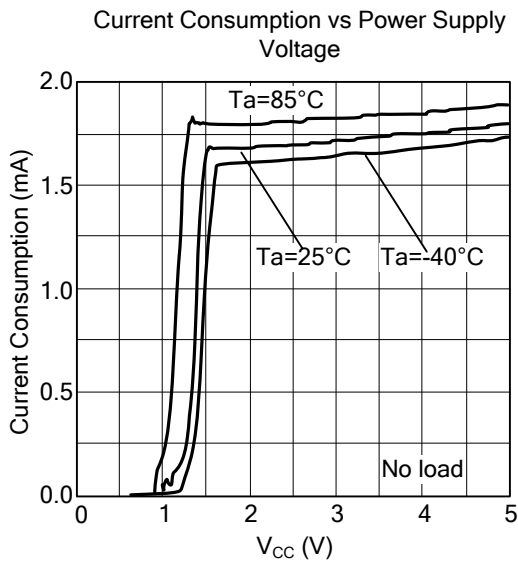
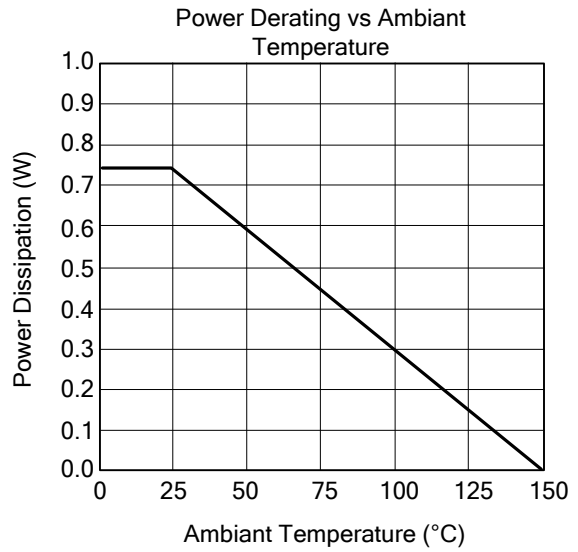
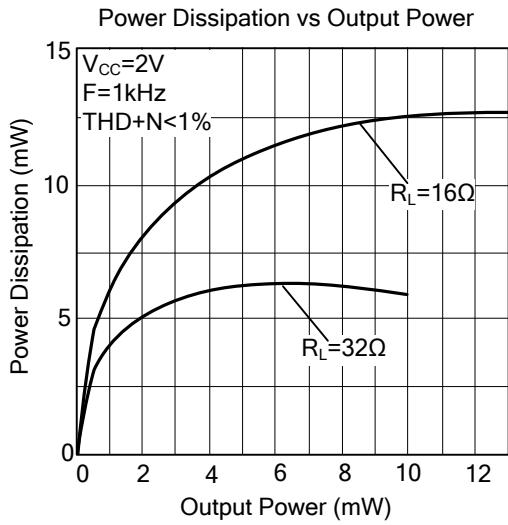

UTC assumes no responsibility for equipment failures that result from using products at values that exceed, even momentarily, rated values (such as maximum ratings, operating condition ranges, or other parameters) listed in products specifications of any and all UTC products described or contained herein. UTC products are not designed for use in life support appliances, devices or systems where malfunction of these products can be reasonably expected to result in personal injury. Reproduction in whole or in part is prohibited without the prior written consent of the copyright owner. The information presented in this document does not form part of any quotation or contract, is believed to be accurate and reliable and may be changed without notice.