

TOSHIBA

Toshiba S4E38XX Series LEDs

S4E38XX

Features

5mm Package
InGaAlP Technology
Water Clear Lens
All Plastic Mold Type
High Power Luminous Intensity

Applications

Traffic
VMS
Roadway Hazard Signs

Maximum Ratings (Ta=25°C)

Characteristic	Symbol	Max.	Unit
Forward Current	I _F	50	mA
Reverse Voltage	V _R	4.00	V
Power Dissipation	P _D	125.00	mW
Operating Temperature	T _{opr}	-30 ~ 85	°C
Storage Temperature	T _{stg}	-40 ~ 120	°C
Soldering Temperature	T _{sol}	260	°C
Soldering Time	-	for 3 sec. max	-

Opto-Electrical Characteristics (Ta=25°C)

Characteristic	Symbol	Test Condition	Min	Typ	Max	Unit
Forward Voltage	V _F	I _F =20mA	-	2.10	2.50	V
Reverse Current	I _R	V _R =4V	-	-	50	μA
Luminous Intensity	I _v	I _F =20mA	2200.00	3500.00	-	mcd
Viewing Angle	2θ ^{1/2}	-	-	17°	-	deg.
Peak Wavelength	λ _p	I _F =20mA	-	590	-	nm
Dominant Wavelength	λ _d	I _F =20mA	-	587	-	nm
Spectral Line Half Width	Δλ	I _F =20mA	-	13	-	nm

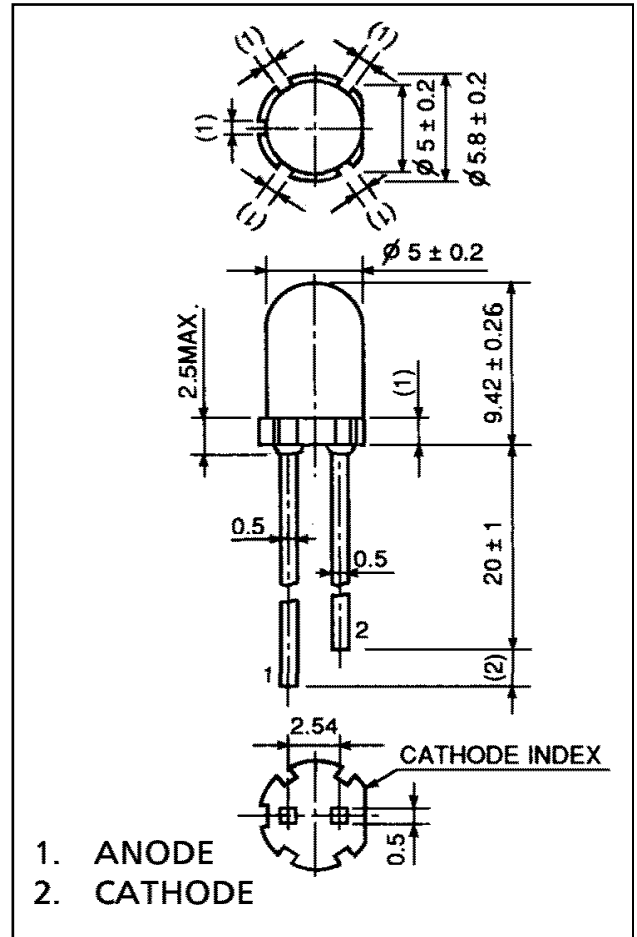

Company Headquarters
3 Northway Lane North
Latham, New York 12110
Toll Free: 800.984.5337
Fax: 518.785.4725

Marktech
Optoelectronics

Web: www.marktechopto.com | Email: info@marktechopto.com

California Sales Office:
950 South Coast Drive, Suite 265
Costa Mesa, California 92626
Toll Free: 800.984.5337
Fax: 714.850.9314
www.DataSheet4U.com

S4E38XX Graphs

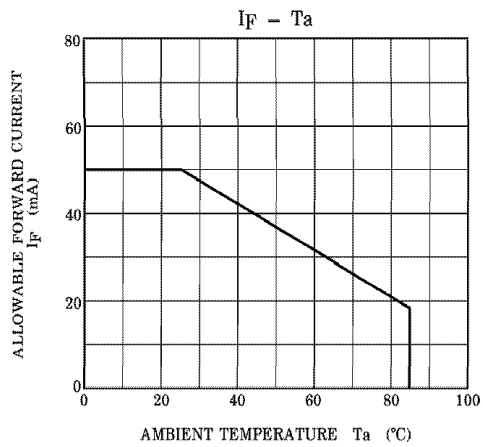
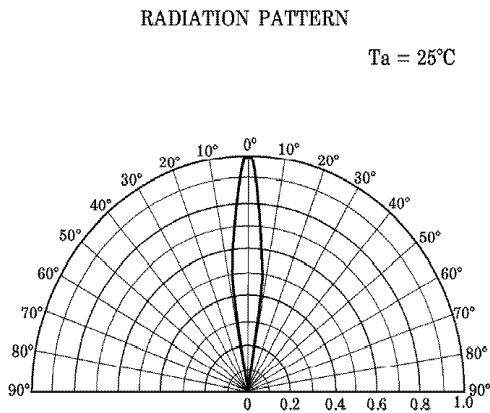
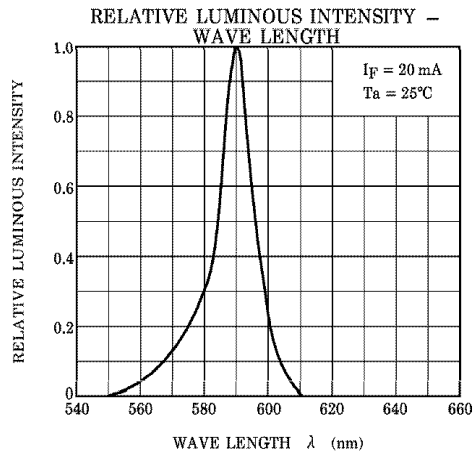
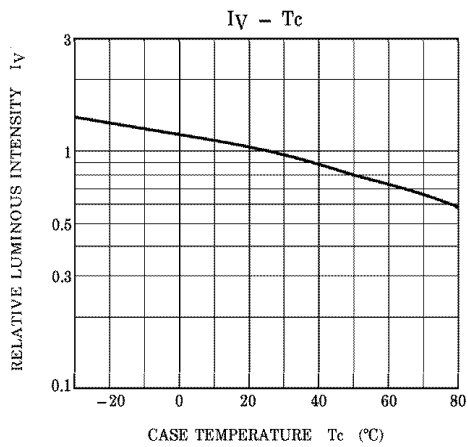
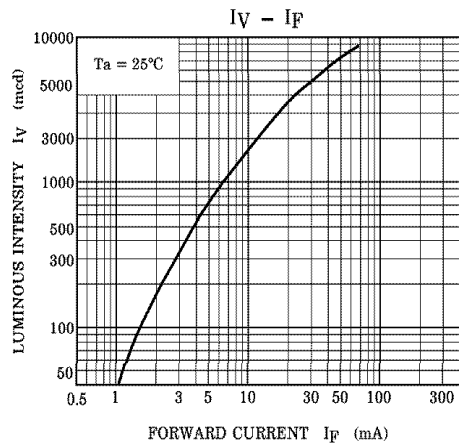
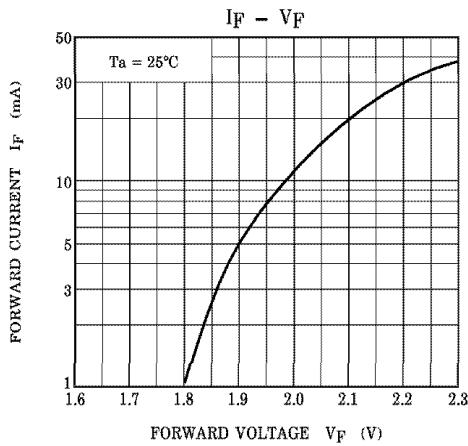



Toshiba S4E38XX Series LEDs

NOTICE:

- TOSHIBA is continually working to improve the quality and reliability of its products. Nevertheless, semiconductor devices in general can malfunction or fail due to their inherent electrical sensitivity and vulnerability to physical stress. It is the responsibility of the buyer, when utilizing TOSHIBA products, to comply with the standards of safety in making a safe design for the entire system, and to avoid situations in which a malfunction or failure of such TOSHIBA products could cause loss of human life, bodily injury or damage to property.
- In developing your designs, please ensure that TOSHIBA products are used within specified operating ranges as set forth in the most recent TOSHIBA products specifications. Also, please keep in mind the precautions and conditions set forth in the "Handling Guide for Semiconductor Devices," or "TOSHIBA Semiconductor Reliability Handbook" etc..
- The TOSHIBA products listed in this document are intended for usage in general electronics applications (computer, personal equipment, office equipment, measuring equipment, industrial robotics, domestic appliances, etc.). These TOSHIBA products are neither intended nor warranted for usage in equipment that requires extraordinarily high quality and/or reliability or a malfunction or failure of which may cause loss of human life or bodily injury ("Unintended Usage"). Unintended Usage include atomic energy control instruments, airplane or spaceship instruments, transportation instruments, traffic signal instruments, combustion control instruments, medical instruments, all types of safety devices, etc.. Unintended Usage of TOSHIBA products listed in this document shall be made at the customer's own risk.
- Gallium arsenide (GaAs) is a substance used in the products described in this document. GaAs dust and fumes are toxic. Do not break, cut or pulverize the product, or use chemicals to dissolve them. When disposing of the products, follow the appropriate regulations. Do not dispose of the products with other industrial waste or with domestic garbage.
- The information contained herein is presented only as a guide for the applications of our products. No responsibility is assumed by TOSHIBA CORPORATION for any infringements of intellectual property or other rights of the third parties which may result from its use. No license is granted by implication or otherwise under any intellectual property or other rights of TOSHIBA CORPORATION or others.
- The information contained herein is subject to change without notice.

Company Headquarters
3 Northway Lane North
Latham, New York 12110
Toll Free: 800.984.5337
Fax: 518.785.4725



Web: www.marktechopto.com | Email: info@marktechopto.com

California Sales Office:
950 South Coast Drive, Suite 265
Costa Mesa, California 92626
Toll Free: 800.984.5337
Fax: 714.850.9314
www.DataSheet4U.com