

**Sensitive Gate
Silicon Controlled Rectifiers
Reverse Blocking Thyristors**

**SCRs
4 AMPERES RMS
600 VOLTS**

FEATURES

- Glass-Passivated Surface for Reliability and Uniformity
- Power Rated at Economical Prices
- Practical Level Triggering and Holding Characteristics
- Flat, Rugged, Thermopad Construction for Low Thermal Resistance, High Heat Dissipation and Durability

TO-126

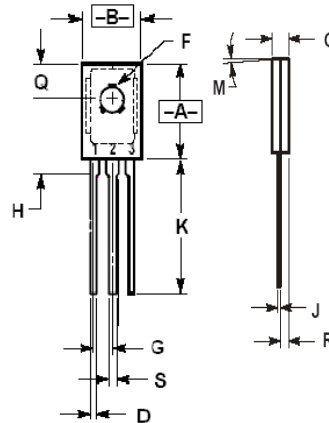

TO126		
DIM.	MIN.	MAX.
A	10.16	11.43
B	7.12	8.38
C	2.29	3.04
D	0.64	0.88
F	2.54	3.3
G	2.04	2.54
H	-	2.54
J	0.39	0.63
K	15.12	16.63
M	3° TYP	
Q	3.31	4.44
R	0.89	1.65
S	0.64	0.88

All Dimensions in millimeter

PIN ASSIGNMENT	
1	Cathode
2	Anode
3	Gate

MAXIMUM RATINGS (T_J= 25°C unless otherwise noticed)

Rating	Symbol	Value	Unit
Peak Repetitive Off- State Voltage (T _J = -40 to 110°C, Sine Wave, 50 to 60 Hz; Gate Open)	V _{DRM} , V _{VRRM}	600	Volts
On-State RMS Current (T _C = 80°C) 180° Conduction Angles	I _{T(RMS)}	4.0	Amp
Peak Non-Repetitive Surge Current (1/2 Cycle, Sine Wave, 60 Hz, T _J = 25°C)	I _{TSM}	25	Amps
Circuit Fusing Consideration (t = 8.3 ms)	$I^2 t$	2.6	A ² s
Forward Peak Gate Power	P _{GM}	1	Watt
Forward Average Gate Power	P _{G(AV)}	0.1	Watt
Operating Junction Temperature Range @ Rate V _{DRM} and V _{VRRM}	T _J	-40 to +110	°C
Storage Temperature Range	T _{stg}	-40 to +150	°C

Notice: (1) V_{DRM} and V_{VRRM} for all types can be applied on a continuous basis. Ratings apply for zero or negative gate voltage; positive gate voltage shall not be applied concurrent with negative potential on the anode. Blocking voltages shall not be tested with a constant current source such that the voltage ratings of the devices are exceeded

THERMAL CHARACTERISTICS

Characteristic	Symbol	Value	Unit
Thermal Resistance - Junction to Case - Junction to Ambient	R _{thJC} R _{thJA}	7.0 75	°C/W
Maximum Lead Temperature for Soldering Purposes 1/16" from Case for 10 Seconds	TL	260	°C

ELECTRICAL CHARACTERISTICS (T_J=25°C unless otherwise noted)

Characteristics	Symbol	Min	Typ	Max	Unit
-----------------	--------	-----	-----	-----	------

OFF CHARACTERISTICS

Peak Repetitive Forward or Reverse Blocking Current (V _{AK} =Rated V _{DRM} and V _{RRM} ; R _{GK} =1K Ohms)	T _J = 25°C	I _{DRM}	----	----	10	uA
	T _J =110°C	I _{RRM}	----	----	200	

ON CHARACTERISTICS

Peak Forward On-State Voltage @T _J =25°C (I _{TM} = 8.0A Peak, Pulse Width ≤ 1.0 ms, Duty Cycle ≤ 1%)	V _{TM}	----	----	2.0	Volts
Gate Trigger Current (V _{AK} = 12 V ; R _L = 100 Ohms) (1)	I _{GT}	----	----	200	uA
Holding Current (V _{AK} = 12 V, R _L = 100 Ohms)	I _H	----	----	5.0	mA
Gate Trigger Voltage (V _{AK} = 12 V ; R _L =100 Ohms) (1)	V _{GT}	----	----	1.0	Volts
Latching Current (V _{AK} = 12 V, R _L = 100 Ohms)	I _L	----	----	10	mA

DYNAMIC CHARACTERISTICS

Critical Rate of Rise of Off-State Voltage (V _{AK} =0.67% Rated V _{DRM} , Exponential Waveform, T _J =110°C , R _{GK} =1Kohm)	dv/dt	----	10	----	V/us
---	-------	------	----	------	------

(1) R_{GK} current is not included in measurement

Symbol	Parameter
V_{DRM}	Peak Repetitive Off State Forward Voltage
I_{DRM}	Peak Forward Blocking Current
V_{RRM}	Peak Repetitive Off State Reverse Voltage
I_{RRM}	Peak Reverse Blocking Current
V_{TM}	Peak on State Voltage
I_H	Holding Current

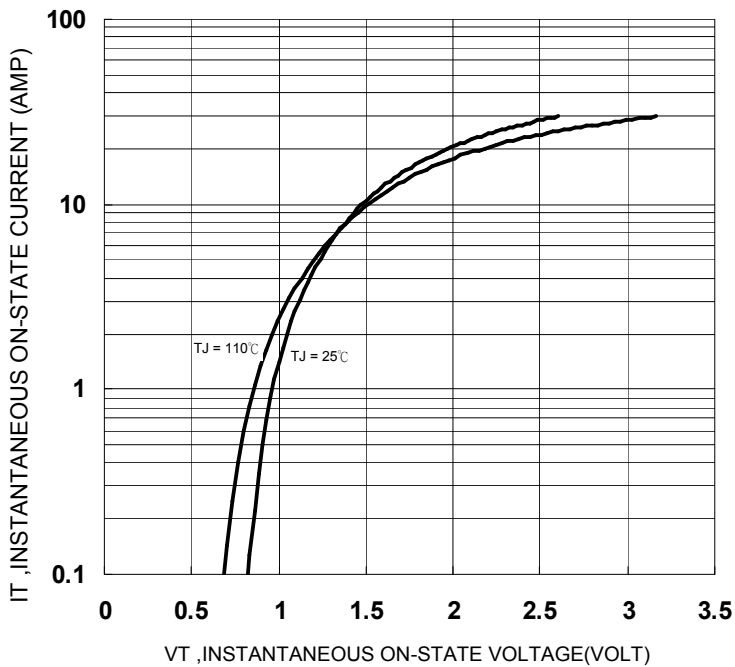
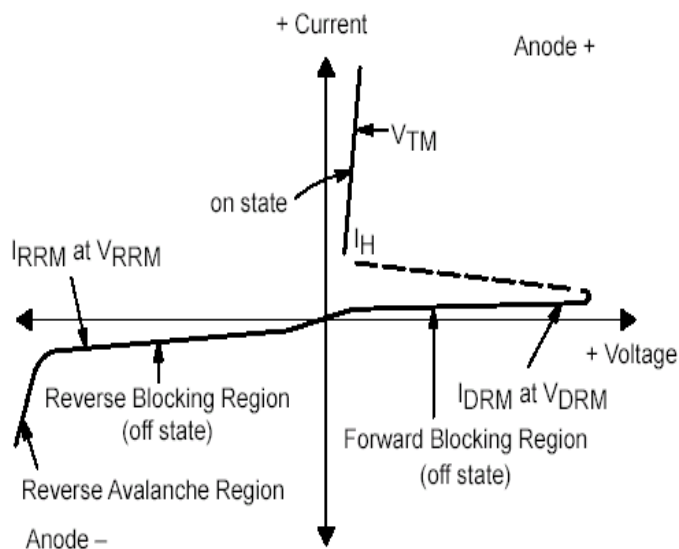
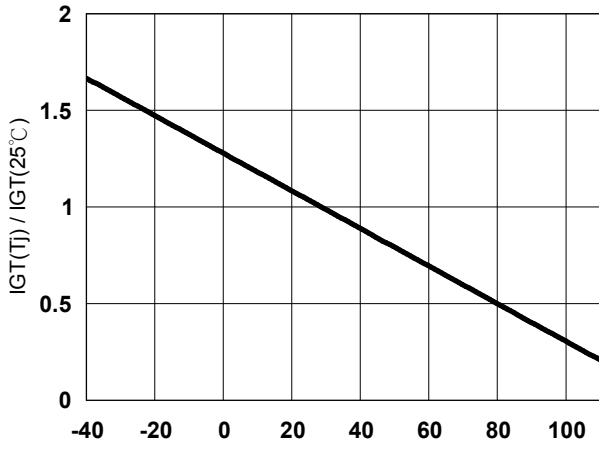
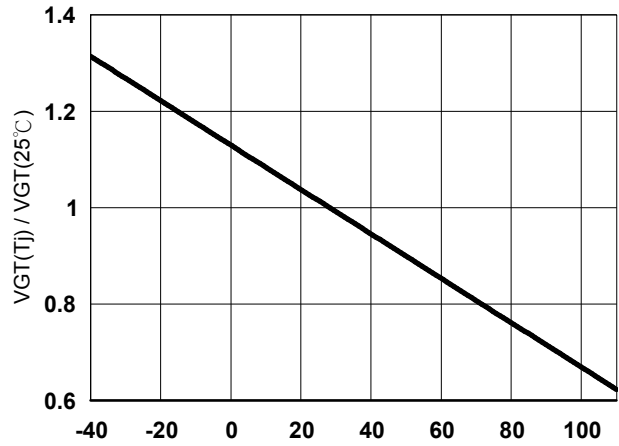

Figure 1. On-State Characteristics



T_J, JUNCTION TEMPERATURE(°C)
 Figure 2. Typical IGT versus T_J



T_J, JUNCTION TEMPERATURE(°C)
 Figure 3. Typical VGT versus T_J

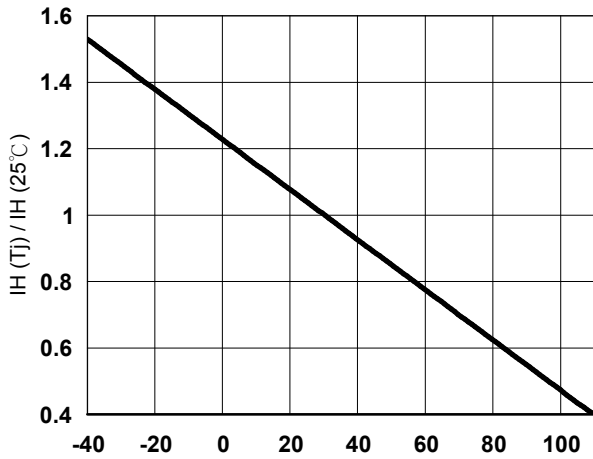

T_J, JUNCTION TEMPERATURE(°C)
 Figure 4. Typical I_H versus T_J

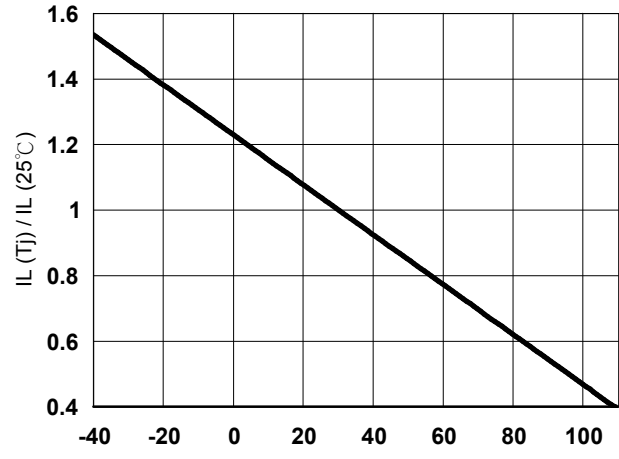

T_J, JUNCTION TEMPERATURE(°C)
 Figure 5. Typical I_L versus T_J

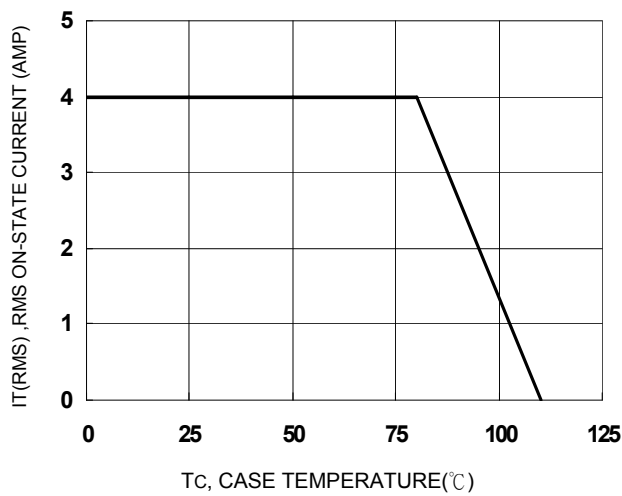

Figure 6. On-State Current Derating Curve

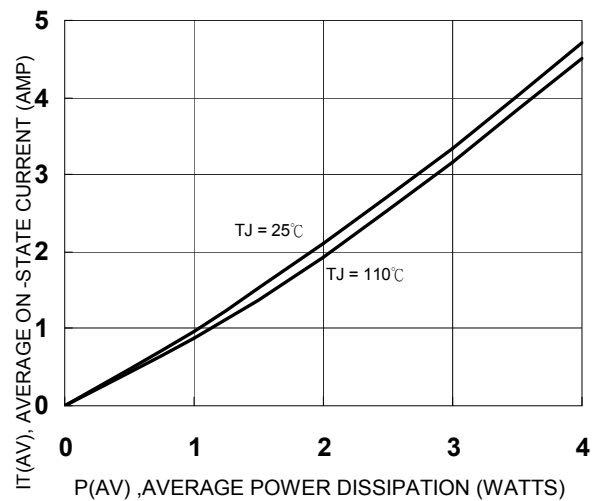
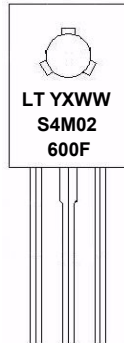

Figure 7. Power Dissipation versus I_T

MARKING DIAGRAMS



Y : Year
X : Subcon
WW : Work Week

ORDERING INFORMATION

Ordering type	Marking	Package	Base qty	Delivery mode
S4M02-600F	S4M02600F	TO-126	50	Tube

S4M02-600F (4A SCR)

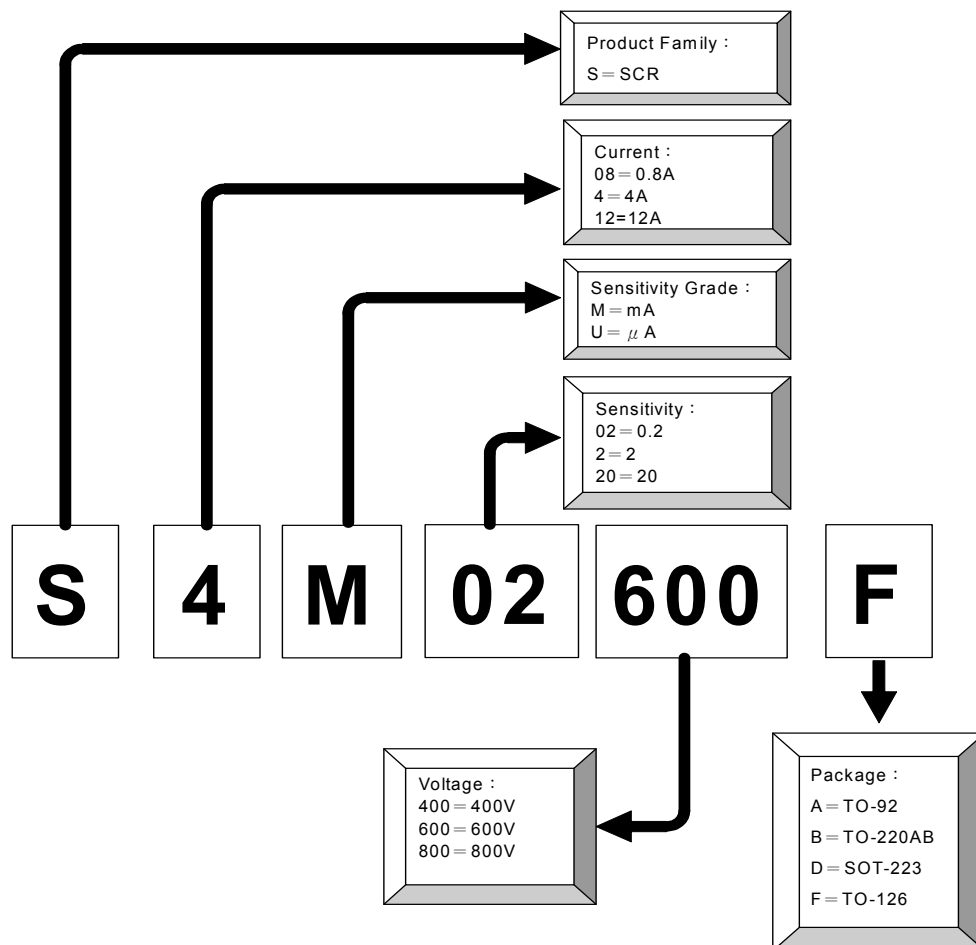

Important Notice and Disclaimer

LSC reserves the right to make changes to this document and its products and specifications at any time without notice. Customers should obtain and confirm the latest product information and specifications before final design, purchase or use.

LSC makes no warranty, representation or guarantee regarding the suitability of its products for any particular purpose, nor does LSC assume any liability for application assistance or customer product design. LSC does not warrant or accept any liability with products which are purchased or used for any unintended or unauthorized application.

No license is granted by implication or otherwise under any intellectual property rights of LSC.

LSC products are not authorized for use as critical components in life support devices or systems without express written approval of LSC.