

SURFACE MOUNT GENERAL PURPOSE SILICON RECTIFIERS

FEATURES

- For surface mounted applications
- Low profile package
- Glass Passivated Chip Junction
- Easy to pick and place
- Lead free in comply with EU RoHS 2011/65/EU directives

MECHANICAL DATA

- Case: SMC
- Terminals: Solderable per MIL-STD-750, Method 2026
- Approx. Weight: 0.22g / 0.0077oz

PINNING

PIN	DESCRIPTION
1	Cathode
2	Anode

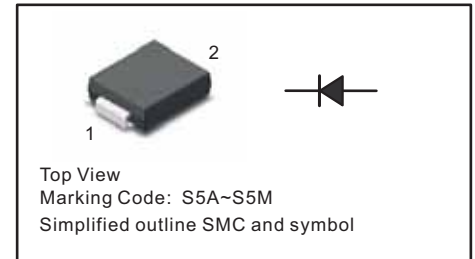

Maximum Ratings and Electrical characteristics

- Ratings at 25 °C ambient temperature unless otherwise specified.
- Single phase half-wave 60 Hz, resistive or inductive load, for capacitive load current derate by 20 %.

Parameter	Symbols	S5A	S5B	S5D	S5G	S5J	S5K	S5M	Units
Maximum Repetitive Peak Reverse Voltage	V_{RRM}	50	100	200	400	600	800	1000	V
Maximum RMS voltage	V_{RMS}	35	70	140	280	420	560	700	V
Maximum DC Blocking Voltage	V_{DC}	50	100	200	400	600	800	1000	V
Maximum Average Forward Rectified Current	$I_{F(AV)}$	5							A
Peak Forward Surge Current 8.3 ms Single Half Sine Wave Superimposed on Rated Load	I_{FSM}	150							A
Maximum Instantaneous Forward Voltage at 5 A	V_F	1.1							V
Maximum DC Reverse Current at Rated DC Blocking Voltage	I_R	5 100							μA
Typical Junction Capacitance ⁽¹⁾	C_j	50							pF
Typical Thermal Resistance ⁽²⁾	$R_{\theta JA}$ $R_{\theta JC}$	35 13							°C/W
Operating and Storage Temperature Range	T_j, T_{stg}	-55 ~ +150							°C

Notes:

1. Measured at 1 MHz and applied reverse voltage of 4 V D.C
2. P.C.B. mounted with 2.0" X 2.0" (5 X 5 cm) copper pad areas.

SURFACE MOUNT GENERAL PURPOSE SILICON RECTIFIERS

RATINGS AND CHARACTERISTIC CURVES S5A - S5M

Fig.1 Forward Current Derating Curve

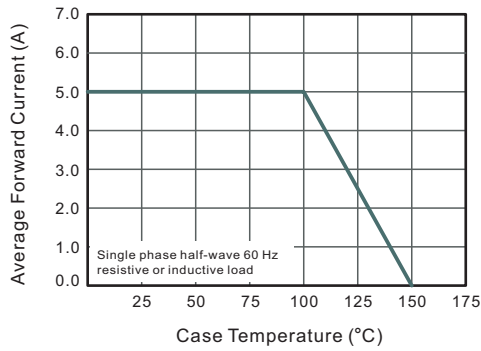

Fig.2 Typical Reverse Characteristics

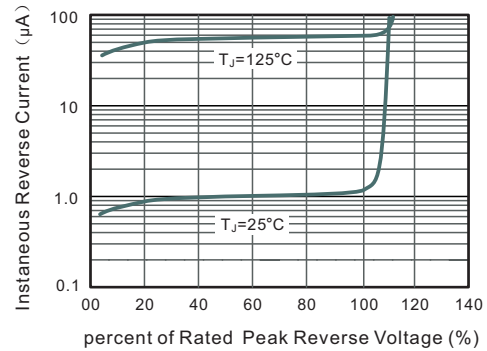

Fig.3 Typical Forward Characteristic

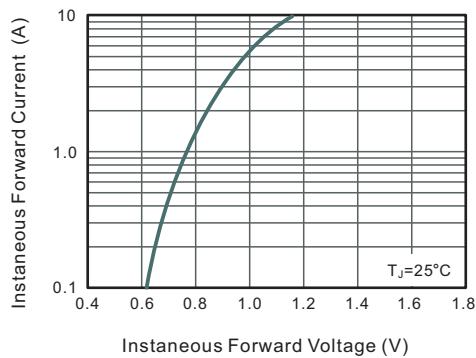

Fig.4 Typical Junction Capacitance

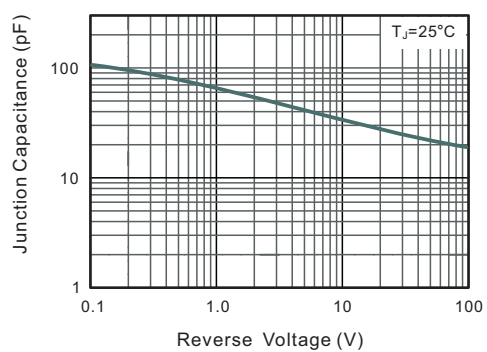
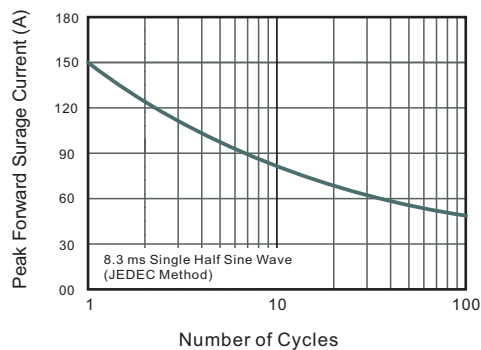

Fig.6 Maximum Non-Repetitive Peak Forward Surge Current



SURFACE MOUNT GENERAL PURPOSE SILICON RECTIFIERS

PACKAGE OUTLINE

Plastic surface mounted package; 2 leads

SMC

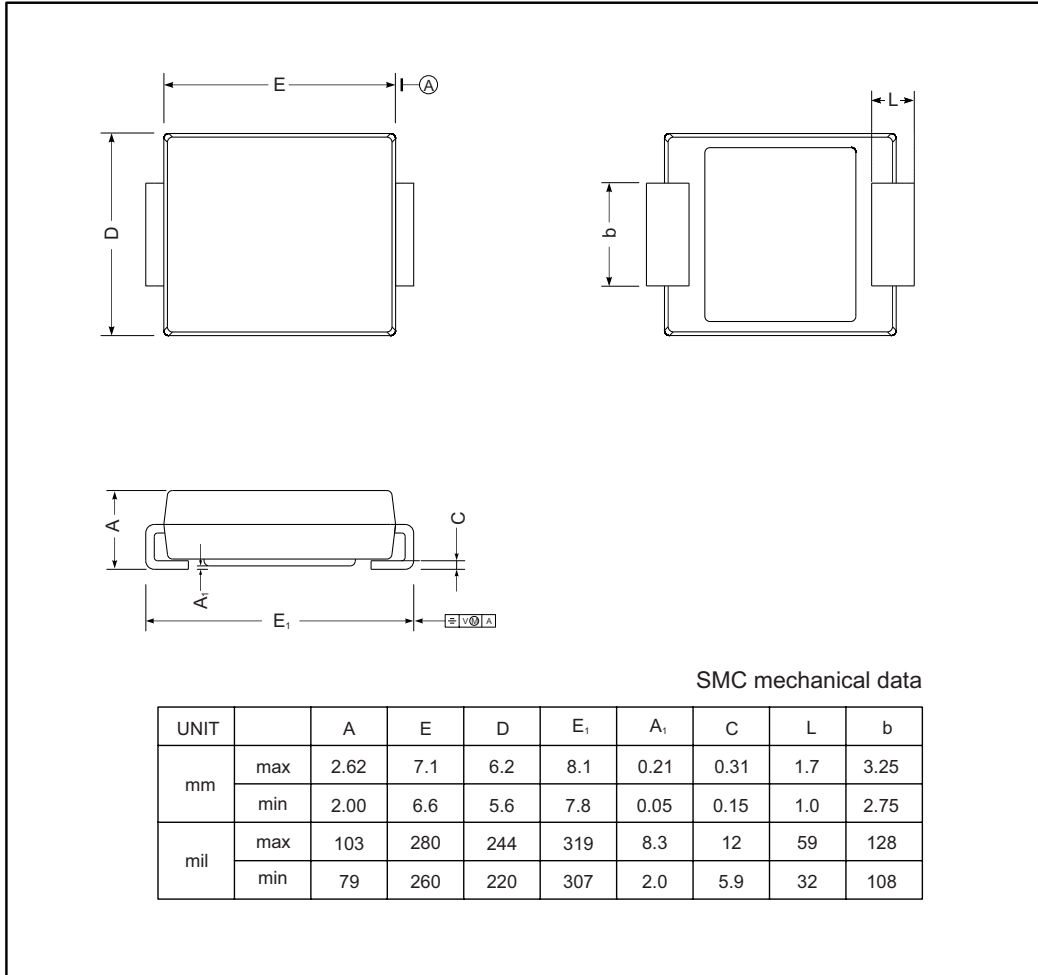

The recommended mounting pad size

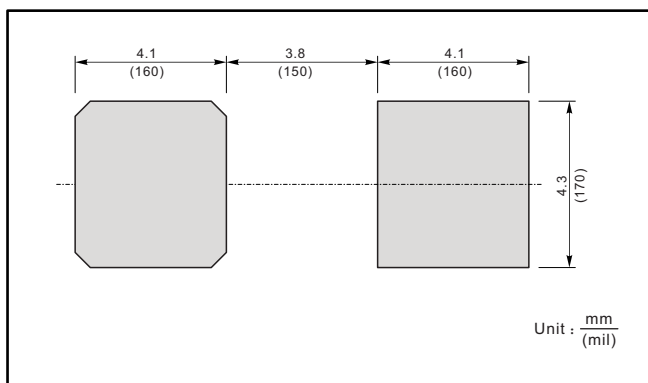

Marking

Type number	Marking code
S5A	S5A
S5B	S5B
S5D	S5D
S5G	S5G
S5J	S5J
S5K	S5K
S5M	S5M

Disclaimer

All product, product specifications and data are subject to change without notice to improve reliability, function or design or otherwise.