

S5ULM2576

Simple Switcher 3A Step-Down Voltage Regulator

Description

The S5ULM2576 series of regulators are monolithic integrated circuits that provide all active functions for a step-down (buck) switching regulator, capable of driving 3A load with excellent line and load regulation. These devices are available in fixed output voltage of 3.3V, 5V, 12V, 15V and an adjustable output version. Requiring a min. number of external components, these regulators are simple to use and include internal frequency components and a fixed-frequency oscillator. The S5ULM2576 series offers a high-efficiency replacement for popular three-terminal linear regulators. It substantially reduces the size of the heat sink, and in some cases no heat sink is required. A standard series of inductors optimized for use with the S5ULM2576 are available from several different manufacturers. The feature greatly simplifies the design of switching-mode power supplies. Other features include a guaranteed $\pm 4\%$ tolerance on output voltage within specified input voltages and output load condition, and $\pm 10\%$ on the oscillator frequency. External shutdown is included, featuring 50 μ A (Typ.) standby current. The output switch includes cycle-by-cycle current limiting, as well as thermal shutdown for full protection under fault condition.

Features

- * High Efficiency
- * Wide Input Voltage Range
- * 52KHz Fixed Frequency Oscillator
- * 3.3V, 5V, 12V, 15V and Adjustable Output Versions
- * Uses Readily Available Standard Inductors
- * TTL Shutdown Capability, Low Power Standby Mode
- * Thermal Shutdown And Current Limit Protection
- * Guaranteed 3A Output Current
- * Efficient Per-regulator For Linear Regulators
- * Requires Only 4 External Components
- * Adjustable Version Output Voltage Range, 1.23V to 37V $\pm 4\%$ Max. Over Line And Load Conditions

Applications

- * Positive To Negative Converter (Buck-Boost)
- * Simple High-Efficiency Step-Down (Buck) Regulator
- * One-Card Switching Regulators

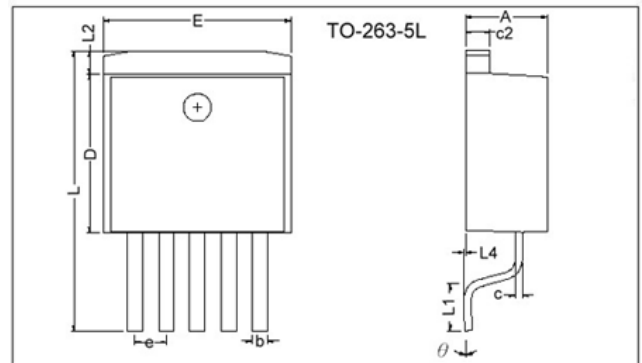

REF.	Millimeter		REF.	Millimeter	
	Min.	Max.		Min.	Max.
A	4.40	4.80	c2	1.25	1.45
b	0.66	0.91	L2	1.27	REF.
L4	0.00	0.30	D	8.6	9.0
c	0.36	0.5	e	1.70	REF.
L1	2.29	2.79	L	14.6	15.8
E	9.80	10.4	θ	0°	8°

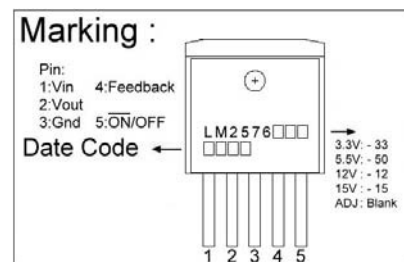

Typical Application (Fixed Output Voltage Version)

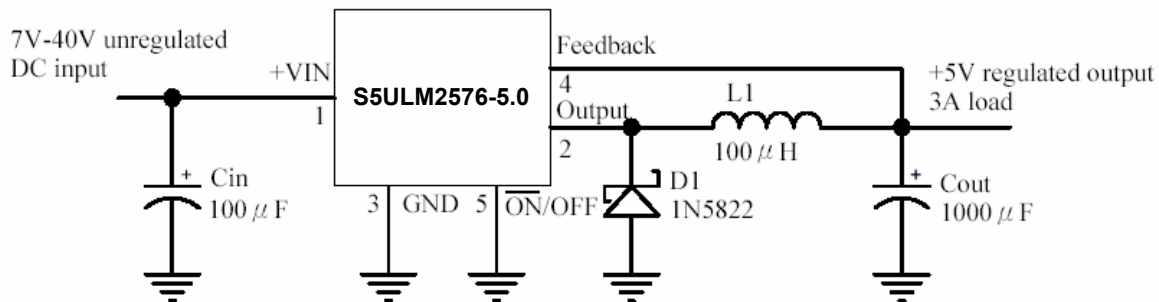

Block Diagram

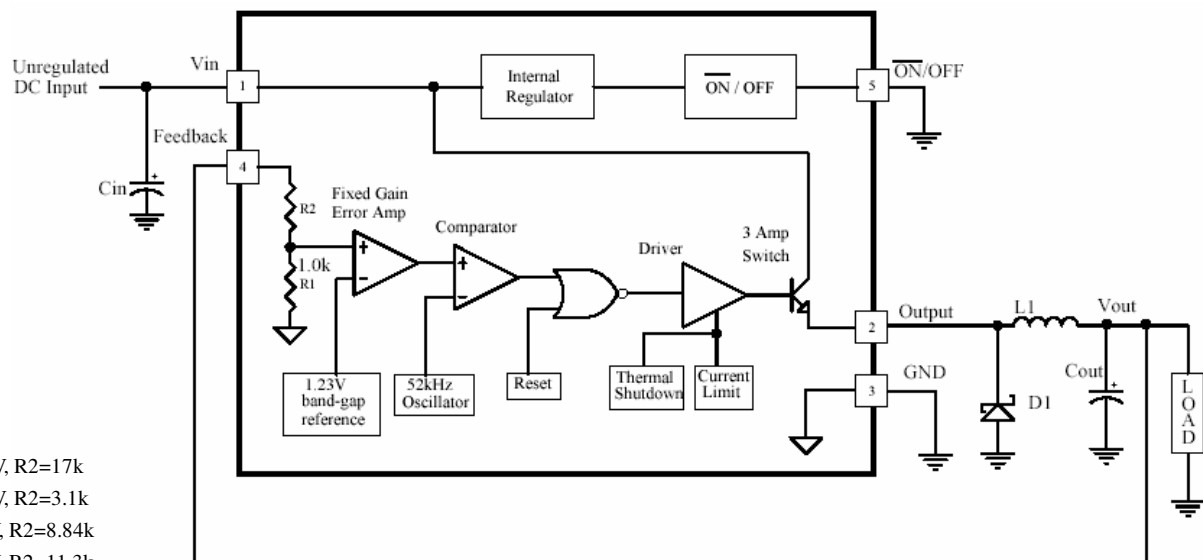

3.3V, R2=17k
5.0V, R2=3.1k
12V, R2=8.84k
15V, R2=11.3k

For Adjustable version, R1=open, R2=0

Absolute Maximum Ratings (Note1)

Parameter	Ratings	Unit
Maximum Supply Voltage	45	V
ON/OFF pin input Voltage	$-0.3 \leq V \leq +V_{IN}$	V
Output Voltage to ground (steady state)	-1	V
Power dissipation	Internally Limited	
Storage Temperature	$-65 \sim +150$	°C
Maximum junction temperature	+150	°C
Minimum ESD rating (C=100pF, R=1.5kΩ)	2k	V
Lead temperature (soldering, 10seconds)	+260	°C

Operating Ratings

Parameter	Ratings	Unit
Temperature range	$-40 \leq T_J \leq +125$	°C
Supply Voltage	40	V

S5ULM2576-3.3 Electrical Characteristics

Specifications with standard type face are for $T_J=25\text{ }^\circ\text{C}$, and those with **boldface type** apply over full operating temperature range

Parameter	Symbol	Conditions	Min	Typ	Max	Unit
System Parameters (Note3) Test Circuit Figure 2						
Output Voltage	V_{OUT}	$V_{IN}=12\text{V}$, $I_{LOAD}=0.5\text{A}$ Circuit of Figure 2	3.234	3.3	3.366	V
Output Voltage	V_{OUT}	$6\text{V} \leq V_{IN} \leq 40\text{V}$, $0.5\text{A} \leq I_{LOAD} \leq 3\text{A}$ Circuit of Figure 2	3.168/ 3.135	3.3	3.432/ 3.465	V
Efficiency	η	$V_{IN}=12\text{V}$, $I_{LOAD}=3\text{A}$		75		%

S5ULM2576-5.0 Electrical Characteristics

Specifications with standard type face are for $T_J=25\text{ }^\circ\text{C}$, and those with **boldface type** apply over full operating temperature range

Parameter	Symbol	Conditions	Min	Typ	Max	Unit
System Parameters (Note3) Test Circuit Figure 2						
Output Voltage	V_{OUT}	$V_{IN}=12\text{V}$, $I_{LOAD}=0.5\text{A}$ Circuit of Figure 2	4.9	5.0	5.1	V
Output Voltage	V_{OUT}	$8\text{V} \leq V_{IN} \leq 40\text{V}$, $0.5\text{A} \leq I_{LOAD} \leq 3\text{A}$ Circuit of Figure 2	4.80/ 4.75	5.0	5.20/ 5.25	V
Efficiency	η	$V_{IN}=12\text{V}$, $I_{LOAD}=3\text{A}$		77		%

S5ULM2576-12 Electrical Characteristics

Specifications with standard type face are for $T_J=25\text{ }^\circ\text{C}$, and those with **boldface type** apply over full operating temperature range

Parameter	Symbol	Conditions	Min	Typ	Max	Unit
System Parameters (Note3) Test Circuit Figure 2						
Output Voltage	V_{OUT}	$V_{IN}=25\text{V}$, $I_{LOAD}=0.5\text{A}$ Circuit of Figure 2	11.76	12	12.24	V
Output Voltage	V_{OUT}	$15\text{V} \leq V_{IN} \leq 40\text{V}$, $0.5\text{A} \leq I_{LOAD} \leq 3\text{A}$ Circuit of Figure 2	11.52/ 11.40	12	12.48/ 12.60	V
Efficiency	η	$V_{IN}=15\text{V}$, $I_{LOAD}=3\text{A}$		88		%

S5ULM2576-15 Electrical Characteristics

Specifications with standard type face are for $T_J=25\text{ }^\circ\text{C}$, and those with **boldface type** apply over full operating temperature range

Parameter	Symbol	Conditions	Min	Typ	Max	Unit
System Parameters (Note3) Test Circuit Figure 2						
Output Voltage	V_{OUT}	$V_{IN}=25\text{V}$, $I_{LOAD}=0.5\text{A}$ Circuit of Figure 2	14.70	15	15.30	V
Output Voltage	V_{OUT}	$18\text{V} \leq V_{IN} \leq 40\text{V}$, $0.5\text{A} \leq I_{LOAD} \leq 3\text{A}$ Circuit of Figure 2	14.40/ 14.25	15	15.60/ 15.75	V
Efficiency	η	$V_{IN}=18\text{V}$, $I_{LOAD}=3\text{A}$		88		%

S5ULM2576 Electrical Characteristics

Specifications with standard type face are for $T_J=25\text{ }^\circ\text{C}$, and those with **boldface type** apply over full operating temperature range

Parameter	Symbol	Conditions	Min	Typ	Max	Unit
System Parameters (Note3) Test Circuit Figure 2						
Output Voltage	V_{OUT}	$V_{IN}=12\text{V}$, $I_{LOAD}=0.5\text{A}$, $V_{OUT}=5\text{V}$ Circuit of Figure 2	1.217	1.230	1.243	V
Output Voltage	V_{OUT}	$8\text{V} \leq V_{IN} \leq 40\text{V}$, $0.5\text{A} \leq I_{LOAD} \leq 3\text{A}$ $V_{OUT}=5\text{V}$, Circuit of Figure 2	1.193/ 1.180	1.230	1.267/ 1.280	V
Efficiency	η	$V_{IN}=12\text{V}$, $I_{LOAD}=3\text{A}$, $V_{OUT}=5\text{V}$		77		%

All Output Voltage Version Electrical Characteristics

Specifications with standard type face are for $T_J=25^\circ\text{C}$, and those with **boldface type** apply over full operating temperature range.

Unless otherwise specified, $V_{IN}=12\text{V}$ for the 3.3V, 5.0V and Adjustable versions, $V_{IN}=25\text{V}$ for 12V version, and $V_{IN}=30\text{V}$ for 15V version.

$I_{LOAD}=0.5\text{A}$

Parameter	Symbol	Conditions	Min	Typ	Max	Unit
Feedback bias current	I_b	$V_{OUT}=5\text{V}$ (adjustable version only)	-	50	100/ 500	nA
Oscillator frequency	f_o	(Note 8)	47/ 42	52	58/ 63	kHz
Saturation voltage	V_{SAT}	$I_{LOAD}=3\text{A}$ (Note 4)	-	1.4	1.8/ 2.0	V
Maximum duty cycle (ON)	DC	(Note 5)	93	98		%
Current limit	ICL	(Note 4, 8)	4.2/ 3.5	5.8	6.9/ 7.5	A
Output leakage current	I_L	(Note 6, 7) Output=0V Output=-1V	- -	- 7.5	2 30	mA
Quiescent current	I_Q	(Note 6)	-	5	10	mA
Standby quiescent current	I_{STBY}	$\overline{\text{ON/OFF}}$ pin=5V (OFF)	-	50	200	μA
ON/OFF Control						
$\overline{\text{ON/OFF}}$ pin logic input level	V_{IH}	$V_{OUT}=0\text{V}$	2.2/ 2.4	1.4	-	V
	V_{IL}	$V_{OUT}=\text{Nominal output voltage}$	-	1.2	1.0/ 0.8	
$\overline{\text{ON/OFF}}$ pin input current	I_{IH}	$\overline{\text{ON/OFF}}$ pin=5V (OFF)	-	12	30	μA
	I_{IL}	$\overline{\text{ON/OFF}}$ pin=0V (ON)	-	0	10	

Note 1: Absolute Maximum Rating indicate limits beyond which damage to the device may occur. Operating Rating indicate conditions for which the device is intended to be functional, but do not guaranteed specific performance limits. For guaranteed specifications and test conditions, see the Electrical Characteristics.

Note 2: All limits guaranteed at room temperature (standard type face) and at temperature extremes (bold type face).

Note 3: External component such as the catch diode, inductor, input and output capacitors can affect switching regulator system performance. When the G5ELM2576 is used as shutdown in the Figure 2 test circuit, system performance will be as shown in system parameters section of Electrical Characteristics.

Note 4: Output pin sourcing current. No diode, inductor or capacitor connected to output.

Note 5: Feedback pin removed from output and connected to 0V.

Note 6: Feedback pin removed from output and connected to +12V for the Adjustable, 3.3V and 5V versions, and +25V for the 12V and 15V versions, to force the output transistor OFF.

Note 7: $V_{IN}=40\text{V}$.

Note 8: The oscillator frequency reduces to approximately 11 kHz in the event of an output short or an overload which causes the regulated output voltage to drop approximately 40% from the nominal output voltage. This self protection feature lowers the average power dissipation of the IC by lowering the minimum duty cycle from 5% down to approximately 2%.

Typical Performance Characteristics (circuit of Figure 1)

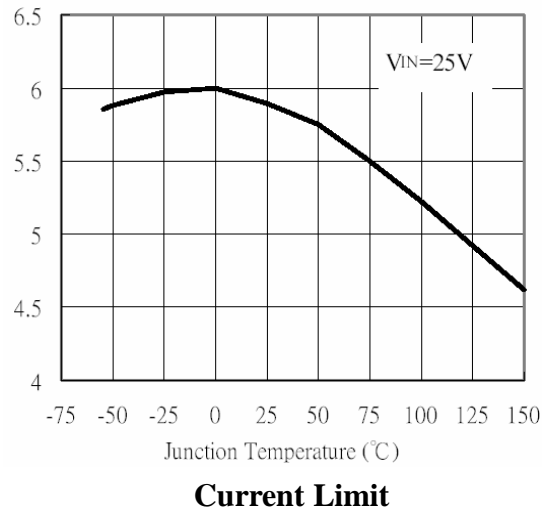
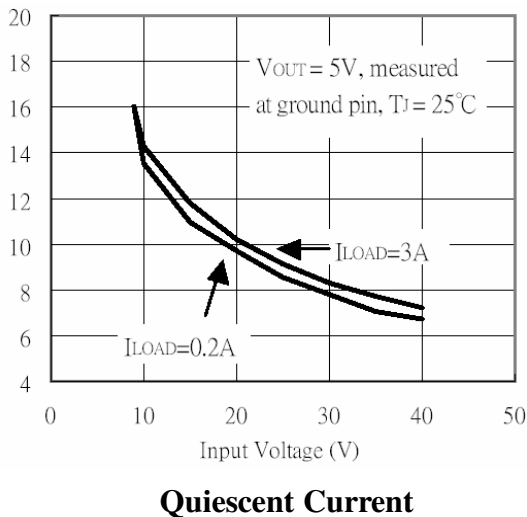
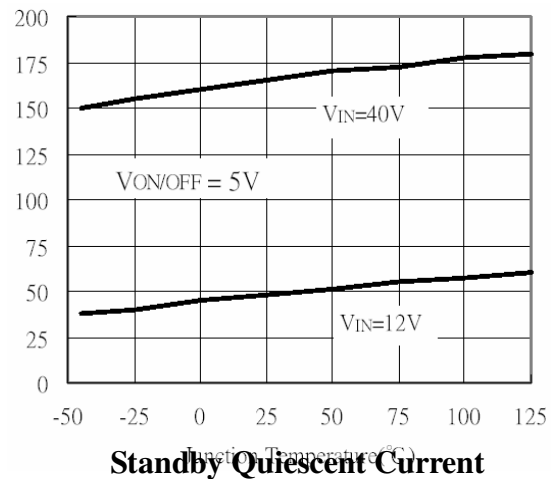
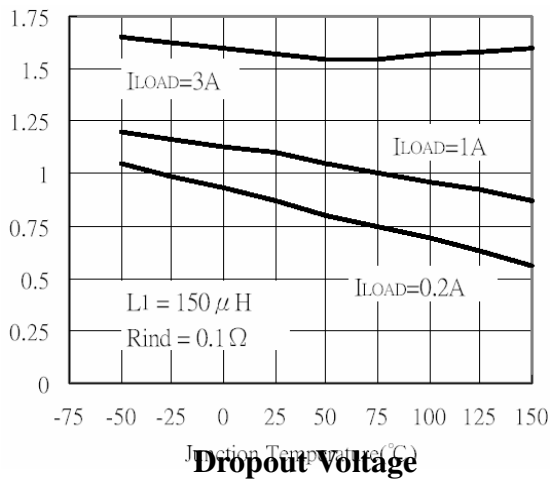
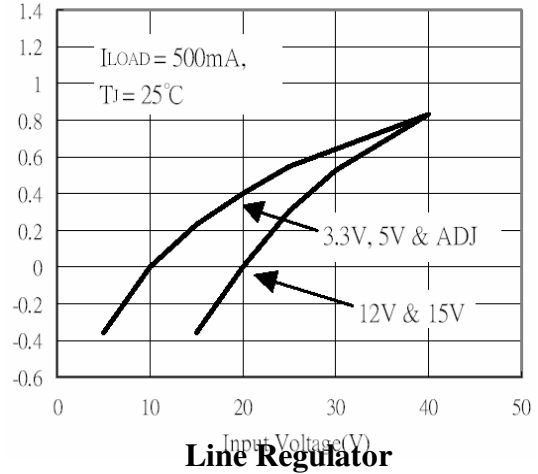
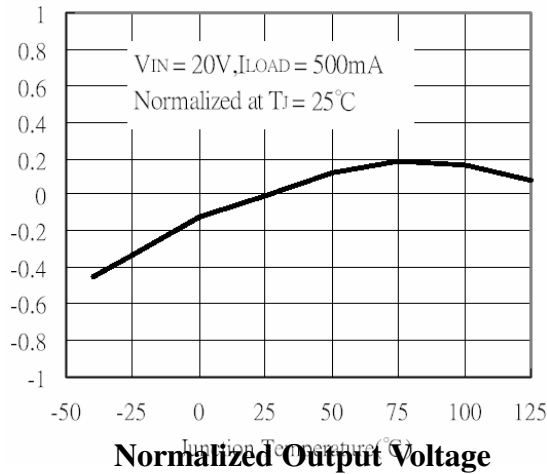

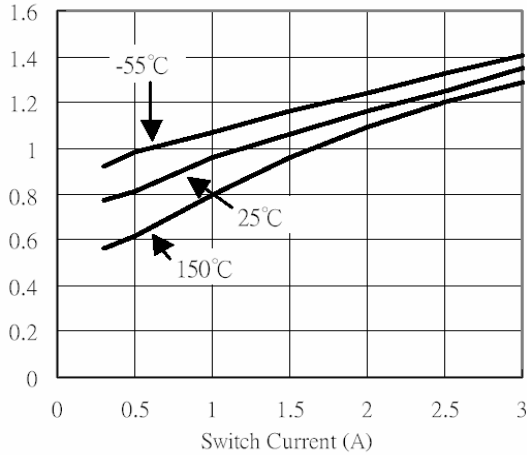

Switch Saturation Voltage

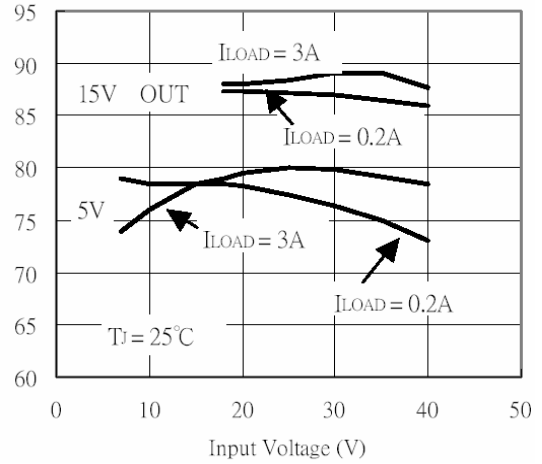

Efficiency

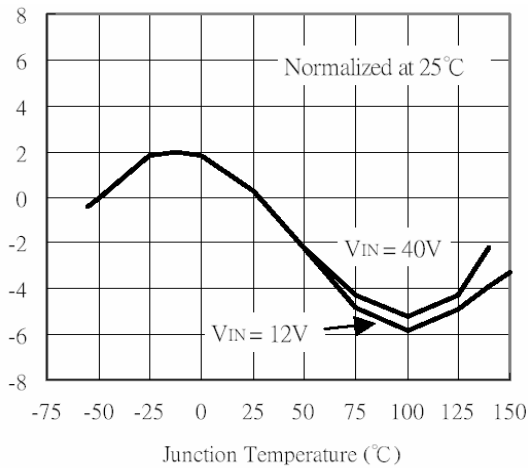

Oscillator Frequency

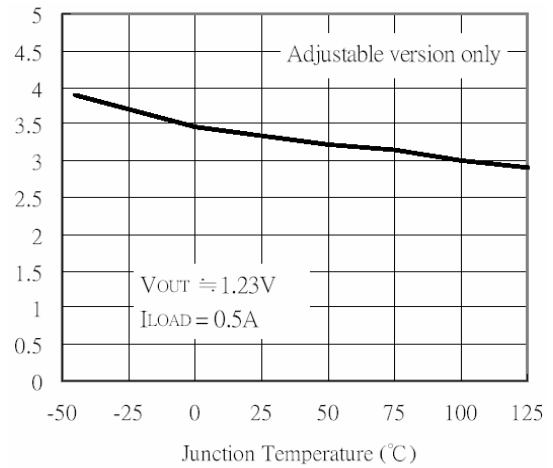

Minimum Operating voltage

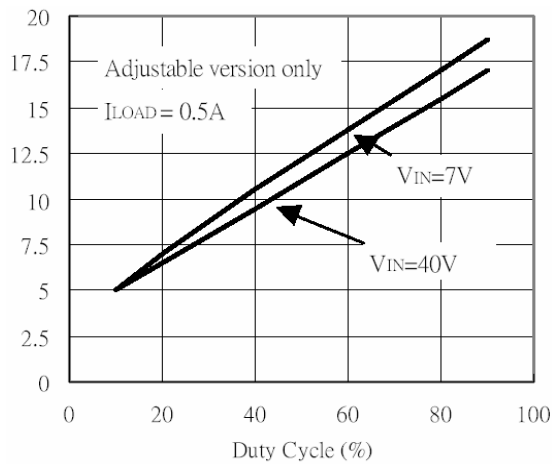

Quiescent Current vs Duty Cycle

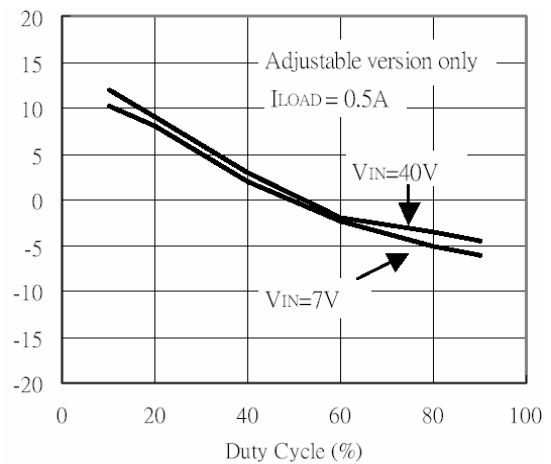

Feedback Voltage vs Duty Cycle

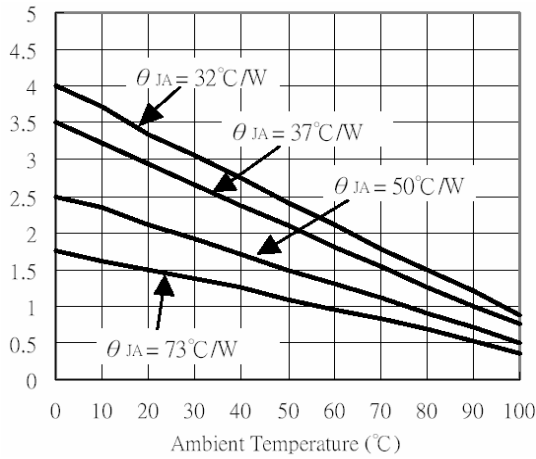

Minimum Power Dissipation

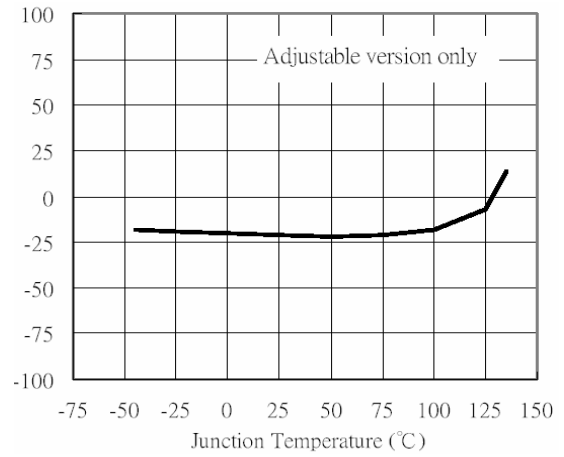

Feedback Pin Current

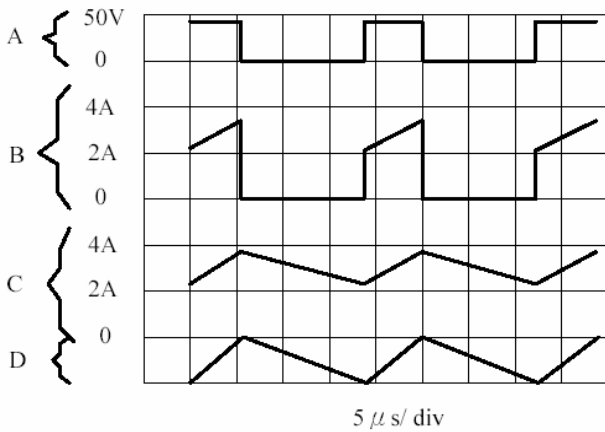

Switching Waveforms

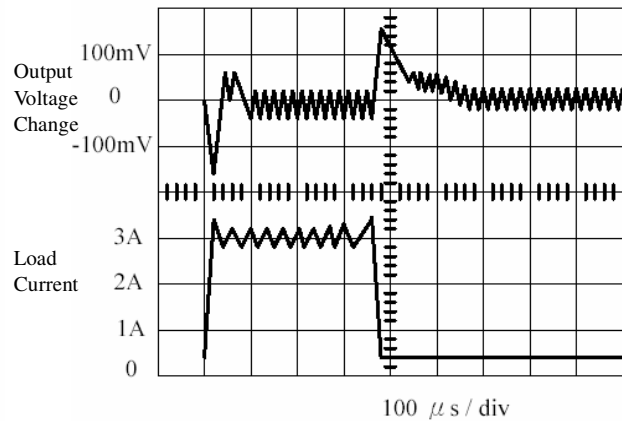

Load Transient Response

VOUT=15V

A: Output Pin Voltage, 50V/div

B: Output Pin Current, 2A/div

C: Inductor Current, 2A/div

D: Output Ripple Voltage, 50mV/div

AC Coupled

Horizontal Time Base: 5us/div

Test Circuit and layout Guidelines

As in any switching regulator, layout is very important. Rapidly switching currents associated with wiring inductance generate voltage transients which can cause problems. For minimal inductance and ground loops, the length of the leads indicated by heavy lines should be kept as short as possible. Single-point grounding (as indicated) or ground plane construction should be used for best results. When using the Adjustable version, physically locate the programming resistors near the regulator, to keep the sensitive feedback wiring short.

Fixed Output Voltage Versions

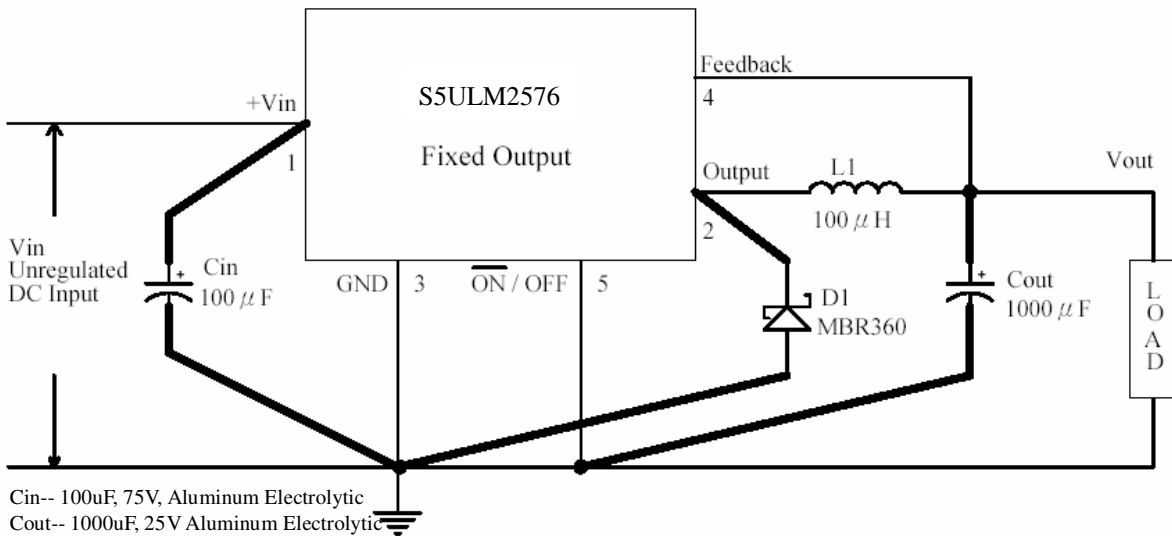

- Cin-- 100µF, 75V, Aluminum Electrolytic
- Cout-- 1000µF, 25V Aluminum Electrolytic
- D1-- Schottky, MBR360
- L1-- 100µH, Pulse Eng, PE92108
- R1-- 2k, 0.1%
- R2-- 6.12k, 0.1%

Adjustable Output Voltage Version

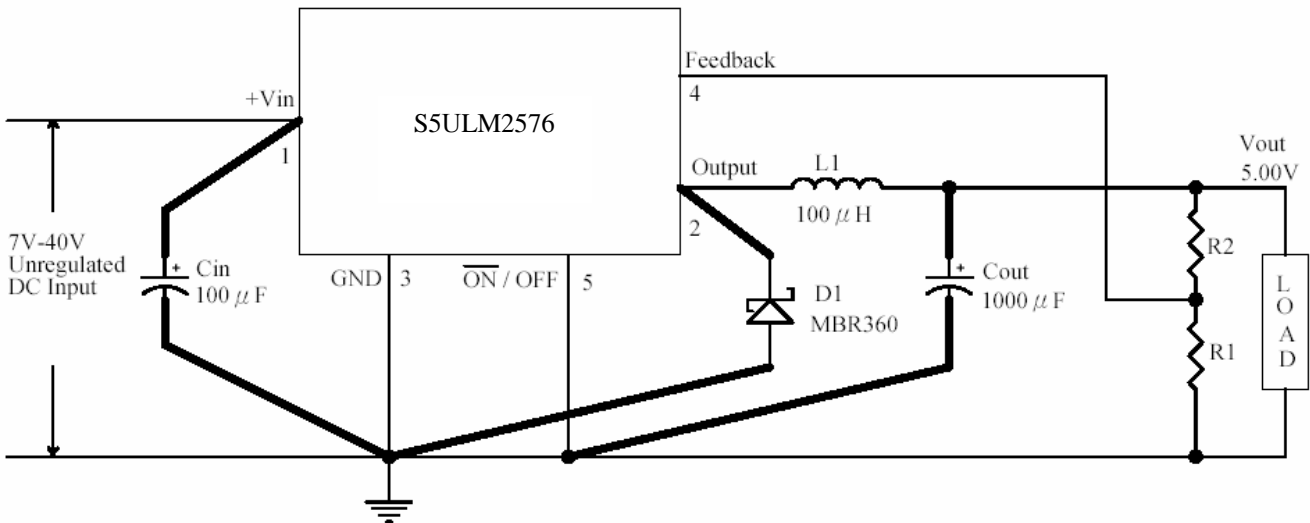

Where VREF=1.23V, R1 between 1k and 5k

Figure 1