

S6C0671

8 BIT 384 CHANNEL TFT-LCD SOURCE DRIVER

February. 2000.

Ver. 0.0

Prepared by:



Myoung-Sik, Suh

mail to: mssuh@samsung.co.kr

Contents in this document are subject to change without notice. No part of this document may be reproduced or transmitted in any form or by any means, electronic or mechanical, for any purpose, without the express written permission of LCD Driver IC Team.

S6C0671 Specification Revision History		
Version	Content	Date
0.0	Original	Feb.2000
0.1	Ac timing	Mar. 2000

CONTENTS

INTRODUCTION	4
FEATURES	4
BLOCK DIAGRAM	5
PIN ASSIGNMENTS	6
PIN DESCRIPTIONS	7
OPERATION DESCRIPTION	8
DISPLAY DATA TRANSFER.....	8
EXTENSION OF OUTPUT	8
RELATIONSHIP BETWEEN INPUT DATA VALUE AND OUTPUT VOLTAGE	8
RELATIONSHIP BETWEEN INPUT DATA AND OUTPUT VOLTAGE VALUE	11
RECOMMENDED OPERATION CONDITIONS	25
DC CHARACTERISTICS	26
AC CHARACTERISTICS	27
WAVEFORMS ($V_{IH} = 0.8 V_{DD1}$, $V_{IL} = 0.2 V_{DD1}$)	28
RELATIONSHIPS BETWEEN CLK1, START PULSE (DIO1, DIO2) AND BLANKING PERIOD	29

INTRODUCTION

The S6C0671 is a 384 channel output, TFT-LCD source driver for an 256 gray scale LCD panel. Data input is based on digital input consisting of 8 bits by 6 dots, which can realize a full-color display of 16,700,000 color by output of 256 values gamma-corrected.

This device has an internal D/A (Digital-to-Analog) converter for each output and 18 (9-by-2) reference voltages. Because the output dynamic range is as large as 7.8 - 14.8 Vp-p, it is unnecessary to operate level inversion of the LCD's common electrode. Besides, to be able to deal with dot-line inversion when mounted on a single-side, output gray scale voltages with different polarity can be output to the odd number output pins and the even output pins.

S6C0671 can be adopted to larger panel, and SHL (shift direction selection) pin makes the use of the LCD panel connection conveniently. Maximum operation clock frequency is 65 MHz at 2.7 V logic operation and it can be applied to the TFT-LCD panel of XGA/SXGA standard.

FEATURES

- TFT active matrix LCD source driver LSI
- 256G/S is possible through 18 (9 by 2) reference voltages and D/A converter
- Both dot inversion display and N-line inversion display are possible
- CMOS level input
- Compatible with gamma-correction
- Input data inversion function (DATPOL1,2)
- Logic supply voltage: 2.7 - 3.6 V
- LCD driver supply voltage: 8.0 - 15.0 V
- Output dynamic range: 7.8 - 14.8 Vp-p
- Maximum operating frequency: $f_{MAX} = 65$ MHz (internal data transmission rate at 2.7 V operation)
- Output: 384 outputs
- TCP

BLOCK DIAGRAM

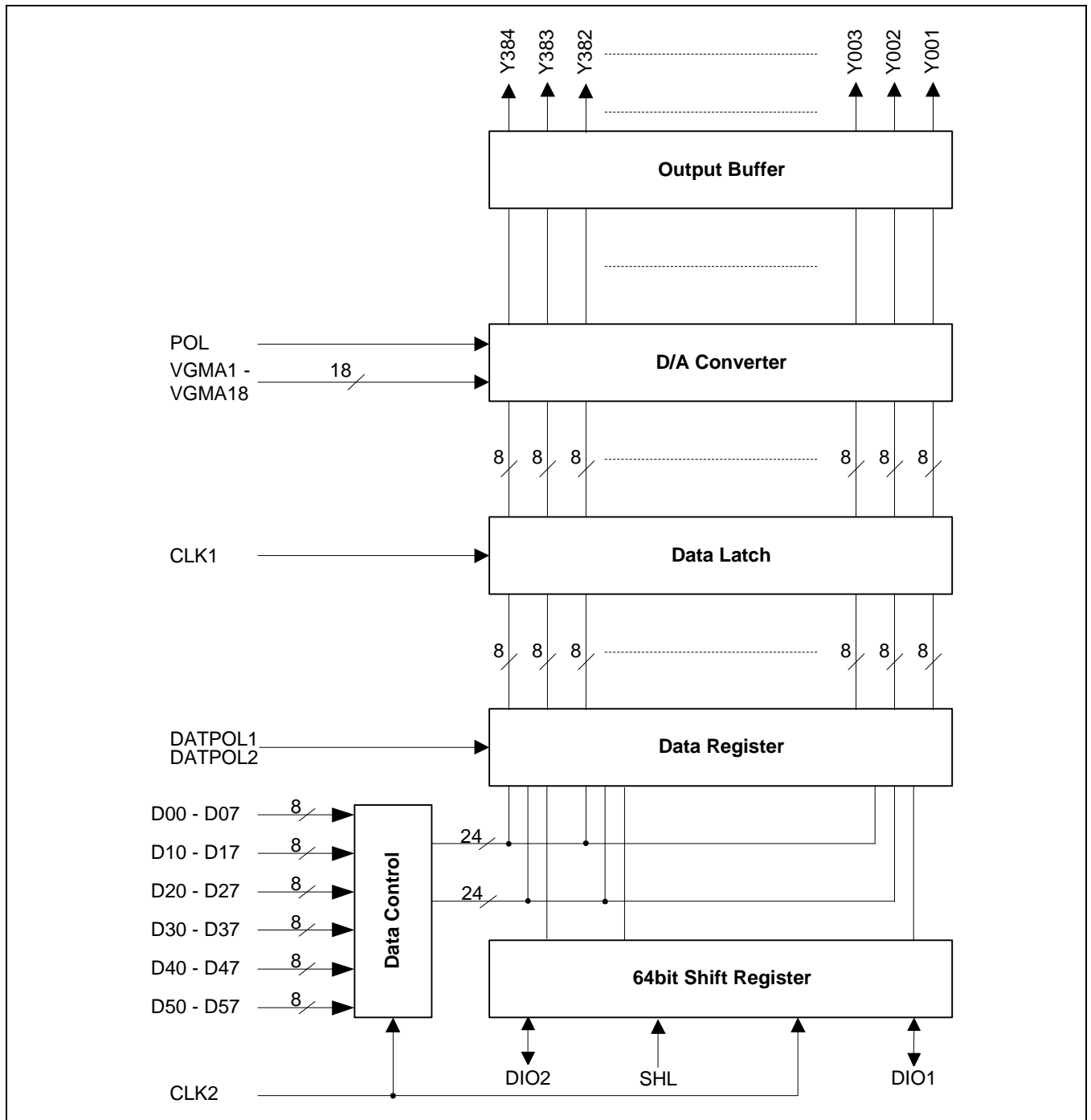

Figure 1. S6C0671 Block Diagram

PIN ASSIGNMENTS

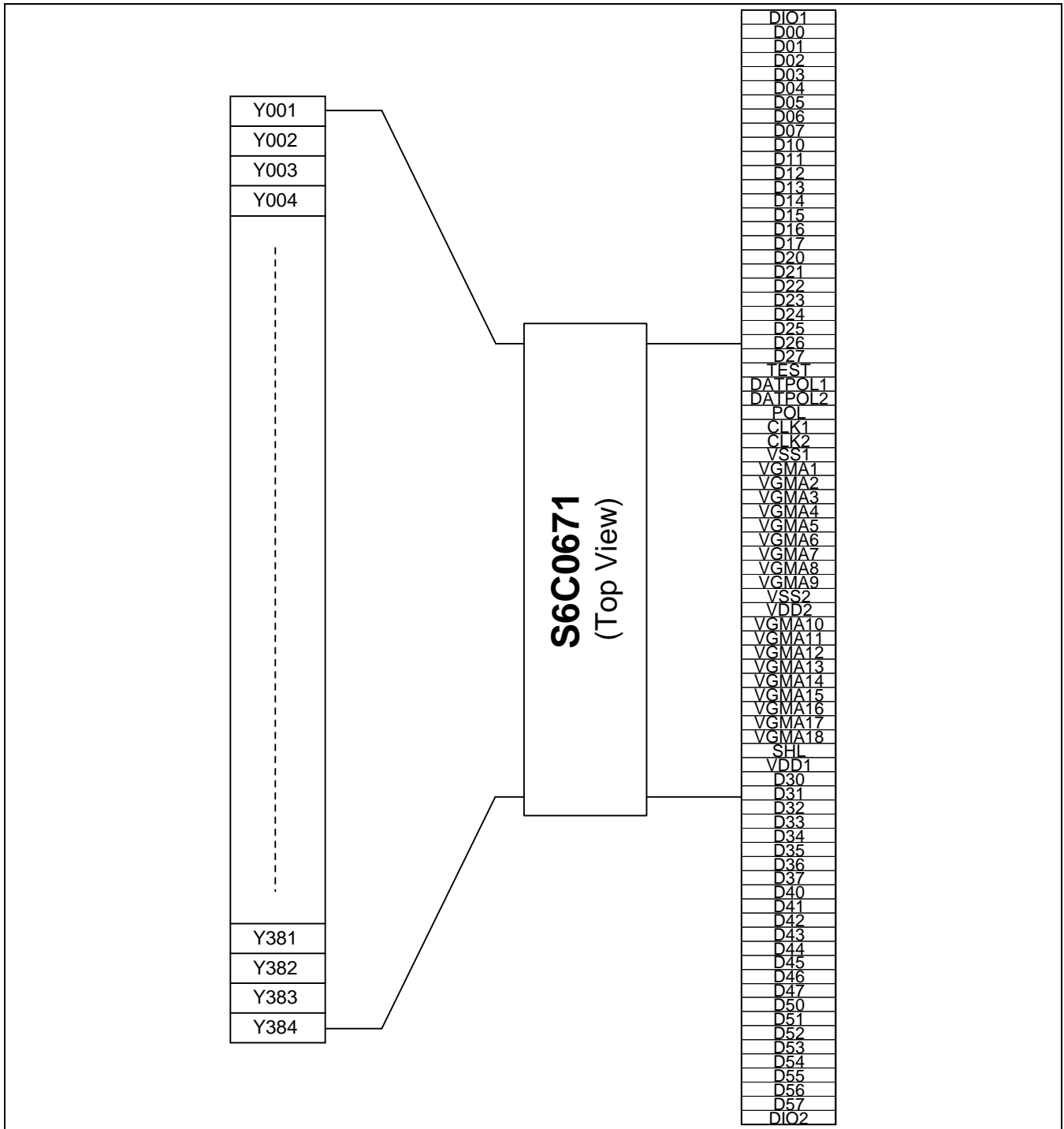

Figure 2. S6C0671 Pin Assignments

PIN DESCRIPTIONS

Symbol	Pin Name	Description
VDD1	Logic power supply	2.7 - 3.6 V
VDD2	Driver power supply	8.0 - 15.0 V
VSS1	Logic ground	Ground (0 V)
VSS2	Driver ground	Ground (0 V)
Y1 – Y384	Driver outputs	The D/A converted 256 gray-scale analog voltage is output.
D0<0:7> - D5<0:7>	Display data input	The display data is input with a width of 48 bits, gray-scale data (8 bits) by 6 dots (R,G,B) DX0: LSB, DX7: MSB
SHL	Shift direction control input	This pin controls the direction of shift register in cascade connection. The shift direction of the shift registers is as follows. SHL = H: DIO1 input, Y1 → Y384, DIO2 output SHL = L: DIO2 input, Y384 → Y1, DIO1 output
DIO1	Start pulse input/output	SHL = H: Used as the start pulse input pin. SHL = L: Used as the start pulse output pin.
DIO2	Start pulse input/output	SHL = H: Used as the start pulse output pin. SHL = L: Used as the start pulse input pin.
DATPOL1 DATPOL2	Data inversion input	DATPOL1,2 = L: Display data is not inverted DATPOL1 = H: Display data of D0<0:7> - D2<0:7> is inverted DATPOL2 = H: Display data of D3<0:7> - D5<0:7> is inverted
POL	Polarity input	POL = H: The reference voltage for odd number outputs are VGMA10 – VGMA18 and those for even number outputs are VGMA1 – VGMA9. POL = L: The reference voltage for odd number outputs are VGMA1 – VGMA9 and those for even number outputs are VGMA10 – VGMA18.
CLK2	Shift clock input	Refer to the shift register's shift clock input. the display data is loaded to the data register at the rising edge of CLK2.
CLK1	Latch input	Latches the contents of the data register at rising edge and transfers them to the D/A converter. Also, after CLK1 input, clears the internal shift register contents. After 1 pulse input on start, operates normally. CLK1 input timing refers to the "Relationships between CLK1 start pulse (DIO1, DIO2) and blanking period" of the switching characteristic waveform. Outputs the G/S data at falling edge.
VGMA1 – VGMA18	Gamma corrected power supplies	Input the gamma corrected power supplies from external source. VDD2 > VGMA1 > VGMA2 > > VGMA17 > VGMA18 > VSS2 Keep gray-scale power supply unchanged during the gray-scale voltage output.
TEST	Test input	TEST = L: Normal operation mode TEST = H: Test mode (OP AMP CUT-OFF, Rpd = 10kΩ)

OPERATION DESCRIPTION

DISPLAY DATA TRANSFER

When DIO1 (or DIO2) pulse is loaded into internal latch on the rising edge of CLK2, DIO1 (or DIO2) pulse enables the operation of data transfer, so display data is valid on the next rising edge of CLK2. Once all the data of 384 channels are loaded into internal latch, it goes into stand-by state automatically, and any new data is not accepted even though CLK2 is provided until next DIO1 (or DIO2) input. When next DIO1 (or DIO2) is provided, new display data is valid on the 2nd rising edge of CLK2 after the rising edge of DIO1 (or DIO2).

EXTENSION OF OUTPUT

Output pin can be adjusted to an extended screen by cascade connection.

(1) SHL = "L"

Connect DIO1 pin of previous stage to the DIO2 pin of next stage and all the input pins except DIO1 and DIO2 are connected together in each device.

(2) SHL = "H"

Connect DIO2 pin of previous stage to the DIO1 pin of next stage and all the input pins except DIO2 and DIO1 are connected together in each device.

RELATIONSHIP BETWEEN INPUT DATA VALUE AND OUTPUT VOLTAGE

The LCD drive output voltages are determined by the input data and 18 (9 by 2) gamma corrected power supplies (VGMA1 - VGMA18). Besides, to be able to deal with dot line inversion when mounted on a single-side, gradation voltages with different polarity can be output to the odd number output pins and the even number output pins. Among 9-by-2 gamma corrected voltages, input gray-scale voltages of the same polarity with respect to the common voltage, for the respective 9 gamma corrected voltages of VGMA1 – VGMA9 and VGMA10 - VGMA18.

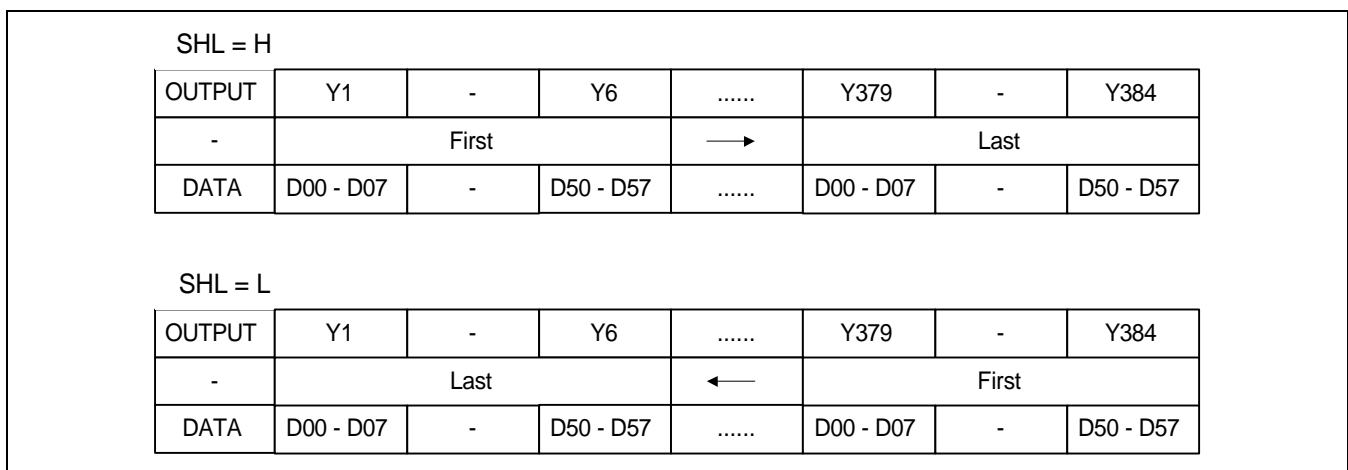

Figure 3. Relationship between Shift Direction and Output Data

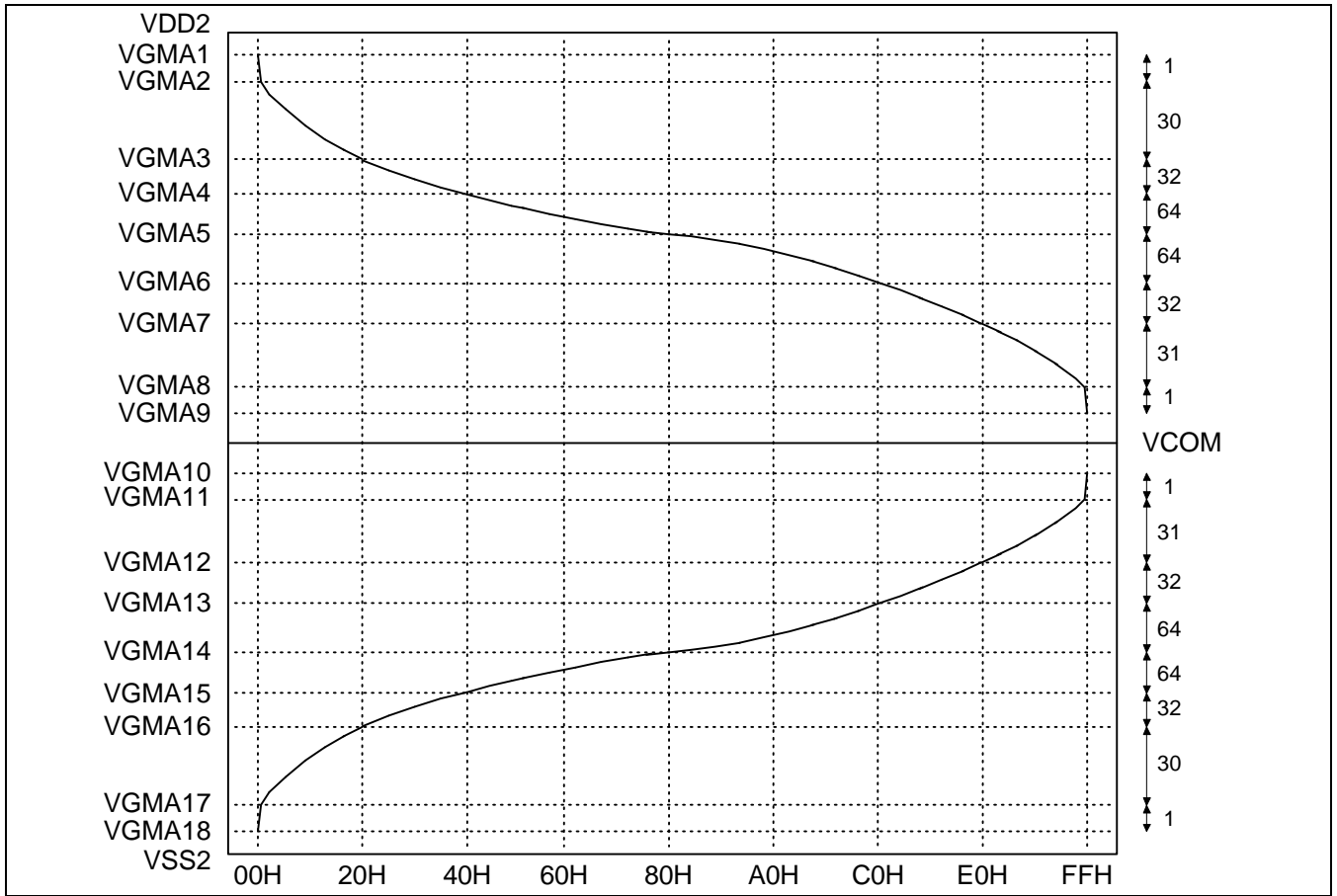

Figure 4. Gamma Correction Curve

Table 1. Resistor Strings (R0 - R254, unit: Ω)

Name	Value	Name	Value	Name	Value
R0	1500	R59 – R66	49	R221	82
R1	350	R67 – R70	46	R222 – R223	87
R2	300	R71 – R74	43	R224	89
R3	265	R75 – R78	40	R225	91
R4	240	R79 – R82	38	R226	92
R5	220	R83 – R86	37	R227	94
R6	202	R87 – R90	35	R228	95
R7	187	R91 – R94	34	R229	96
R8	174	R95 – R98	32	R230 – R231	97
R9	162	R99 – R102	31	R232	98
R10	150	R103 – R106	29	R233	99
R11	140	R107 – R114	28	R234	100
R12	130	R115 – R122	26	R235	102
R13	120	R123 – R130	25	R236 – R237	104
R14	110	R131 – R134	28	R238	106
R15	105	R135 – R138	31	R239	108
R16	100	R139 – R146	34	R240 – R241	110
R17	95	R147 – R150	37	R242	112
R18	92	R151 – R154	40	R243	114
R19	89	R155 – R162	43	R244	116
R20	86	R163 – R166	46	R245 – R246	118
R21	83	R167 – R170	49	R247 – R248	120
R22	82	R171 – R174	52	R249	122
R23 – R26	81	R175 – R178	55	R250	124
R27 – R30	79	R179 – R186	58	R251	127
R31 – R34	78	R187 – R194	61	R252	131
R35 – R38	71	R195 – R202	64	R253	135
R39 – R42	66	R203 – R210	67	R254	1500
R43 – R46	61	R211 – R214	70		
R47 – R50	58	R215 – R218	73		
R51 - R54	55	R219	74		
R55 - R58	52	R220	78		

RELATIONSHIP BETWEEN INPUT DATA AND OUTPUT VOLTAGE VALUE

Table 2. Relationship between Input Data and Output Voltage Value (1)

Input data	DX7 DX6 DX5 DX4 DX3 DX2 DX1 DX0	G/S	Output voltage
00H	0 0 0 0 0 0 0 0	VH0	VGMA1
01H	0 0 0 0 0 0 0 1	VH1	VGMA2
02H	0 0 0 0 0 0 1 0	VH2	$VGMA2 + (VGMA3 - VGMA2) \times 350 / 4122$
03H	0 0 0 0 0 0 1 1	VH3	$VGMA2 + (VGMA3 - VGMA2) \times 650 / 4122$
04H	0 0 0 0 0 1 0 0	VH4	$VGMA2 + (VGMA3 - VGMA2) \times 915 / 4122$
05H	0 0 0 0 0 1 0 1	VH5	$VGMA2 + (VGMA3 - VGMA2) \times 1155 / 4122$
06H	0 0 0 0 0 1 1 0	VH6	$VGMA2 + (VGMA3 - VGMA2) \times 1375 / 4122$
07H	0 0 0 0 0 1 1 1	VH7	$VGMA2 + (VGMA3 - VGMA2) \times 1577 / 4122$
08H	0 0 0 0 1 0 0 0	VH8	$VGMA2 + (VGMA3 - VGMA2) \times 1764 / 4122$
09H	0 0 0 0 1 0 0 1	VH9	$VGMA2 + (VGMA3 - VGMA2) \times 1938 / 4122$
0AH	0 0 0 0 1 0 1 0	VH10	$VGMA2 + (VGMA3 - VGMA2) \times 2100 / 4122$
0BH	0 0 0 0 1 0 1 1	VH11	$VGMA2 + (VGMA3 - VGMA2) \times 2250 / 4122$
0CH	0 0 0 0 1 1 0 0	VH12	$VGMA2 + (VGMA3 - VGMA2) \times 2390 / 4122$
0DH	0 0 0 0 1 1 0 1	VH13	$VGMA2 + (VGMA3 - VGMA2) \times 2520 / 4122$
0EH	0 0 0 0 1 1 1 0	VH14	$VGMA2 + (VGMA3 - VGMA2) \times 2640 / 4122$
0FH	0 0 0 0 1 1 1 1	VH15	$VGMA2 + (VGMA3 - VGMA2) \times 2750 / 4122$
10H	0 0 0 1 0 0 0 0	VH16	$VGMA2 + (VGMA3 - VGMA2) \times 2855 / 4122$
11H	0 0 0 1 0 0 0 1	VH17	$VGMA2 + (VGMA3 - VGMA2) \times 2955 / 4122$
12H	0 0 0 1 0 0 1 0	VH18	$VGMA2 + (VGMA3 - VGMA2) \times 3040 / 4122$
13H	0 0 0 1 0 0 1 1	VH19	$VGMA2 + (VGMA3 - VGMA2) \times 3132 / 4122$
14H	0 0 0 1 0 1 0 0	VH20	$VGMA2 + (VGMA3 - VGMA2) \times 3221 / 4122$
15H	0 0 0 1 0 1 0 1	VH21	$VGMA2 + (VGMA3 - VGMA2) \times 3307 / 4122$
16H	0 0 0 1 0 1 1 0	VH22	$VGMA2 + (VGMA3 - VGMA2) \times 3390 / 4122$
17H	0 0 0 1 0 1 1 1	VH23	$VGMA2 + (VGMA3 - VGMA2) \times 3472 / 4122$
18H	0 0 0 1 1 0 0 0	VH24	$VGMA2 + (VGMA3 - VGMA2) \times 3553 / 4122$
19H	0 0 0 1 1 0 0 1	VH25	$VGMA2 + (VGMA3 - VGMA2) \times 3634 / 4122$
1AH	0 0 0 1 1 0 1 0	VH26	$VGMA2 + (VGMA3 - VGMA2) \times 3715 / 4122$
1BH	0 0 0 1 1 0 1 1	VH27	$VGMA2 + (VGMA3 - VGMA2) \times 3796 / 4122$
1CH	0 0 0 1 1 1 0 0	VH28	$VGMA2 + (VGMA3 - VGMA2) \times 3875 / 4122$
1DH	0 0 0 1 1 1 0 1	VH29	$VGMA2 + (VGMA3 - VGMA2) \times 3944 / 4122$
1EH	0 0 0 1 1 1 1 0	VH30	$VGMA2 + (VGMA3 - VGMA2) \times 4023 / 4122$
1FH	0 0 0 1 1 1 1 1	VH31	VGMA3
20H	0 0 1 0 0 0 0 0	VH32	$VGMA3 + (VGMA4 - VGMA3) \times 78 / 1960$
21H	0 0 1 0 0 0 0 1	VH33	$VGMA3 + (VGMA4 - VGMA3) \times 156 / 1960$
22H	0 0 1 0 0 0 1 0	VH34	$VGMA3 + (VGMA4 - VGMA3) \times 234 / 1960$
23H	0 0 1 0 0 0 1 1	VH35	$VGMA3 + (VGMA4 - VGMA3) \times 312 / 1960$
24H	0 0 1 0 0 1 0 0	VH36	$VGMA3 + (VGMA4 - VGMA3) \times 383 / 1960$
25H	0 0 1 0 0 1 0 1	VH37	$VGMA3 + (VGMA4 - VGMA3) \times 454 / 1960$
26H	0 0 1 0 0 1 1 0	VH38	$VGMA3 + (VGMA4 - VGMA3) \times 525 / 1960$
27H	0 0 1 0 0 1 1 1	VH39	$VGMA3 + (VGMA4 - VGMA3) \times 596 / 1960$

NOTE: VDD2>VGMA1>VGMA2>VGMA3>VGMA4>VGMA5>VGMA6>VGMA7>VGMA8>VGMA9

Table 2. Relationship between Input Data and Output Voltage Value (2)

Input data	DX7 DX6 DX5 DX4 DX3 DX2 DX1 DX0	G/S	Output voltage
28H	0 0 1 0 1 0 0 0	VH40	$VGMA3 + (VGMA4 - VGMA3) \times 662 / 1960$
29H	0 0 1 0 1 0 0 1	VH41	$VGMA3 + (VGMA4 - VGMA3) \times 728 / 1960$
2AH	0 0 1 0 1 0 1 0	VH42	$VGMA3 + (VGMA4 - VGMA3) \times 794 / 1960$
2BH	0 0 1 0 1 0 1 1	VH43	$VGMA3 + (VGMA4 - VGMA3) \times 860 / 1960$
2CH	0 0 1 0 1 1 0 0	VH44	$VGMA3 + (VGMA4 - VGMA3) \times 921 / 1960$
2DH	0 0 1 0 1 1 0 1	VH45	$VGMA3 + (VGMA4 - VGMA3) \times 982 / 1960$
2EH	0 0 1 0 1 1 1 0	VH46	$VGMA3 + (VGMA4 - VGMA3) \times 1043 / 1960$
2FH	0 0 1 0 1 1 1 1	VH47	$VGMA3 + (VGMA4 - VGMA3) \times 1104 / 1960$
30H	0 0 1 1 0 0 0 0	VH48	$VGMA3 + (VGMA4 - VGMA3) \times 1162 / 1960$
31H	0 0 1 1 0 0 0 1	VH49	$VGMA3 + (VGMA4 - VGMA3) \times 1220 / 1960$
32H	0 0 1 1 0 0 1 0	VH50	$VGMA3 + (VGMA4 - VGMA3) \times 1278 / 1960$
33H	0 0 1 1 0 0 1 1	VH51	$VGMA3 + (VGMA4 - VGMA3) \times 1336 / 1960$
34H	0 0 1 1 0 1 0 0	VH52	$VGMA3 + (VGMA4 - VGMA3) \times 1391 / 1960$
35H	0 0 1 1 0 1 0 1	VH53	$VGMA3 + (VGMA4 - VGMA3) \times 1446 / 1960$
36H	0 0 1 1 0 1 1 0	VH54	$VGMA3 + (VGMA4 - VGMA3) \times 1501 / 1960$
37H	0 0 1 1 0 1 1 1	VH55	$VGMA3 + (VGMA4 - VGMA3) \times 1556 / 1960$
38H	0 0 1 1 1 0 0 0	VH56	$VGMA3 + (VGMA4 - VGMA3) \times 1608 / 1960$
39H	0 0 1 1 1 0 0 1	VH57	$VGMA3 + (VGMA4 - VGMA3) \times 1660 / 1960$
3AH	0 0 1 1 1 0 1 0	VH58	$VGMA3 + (VGMA4 - VGMA3) \times 1712 / 1960$
3BH	0 0 1 1 1 0 1 1	VH59	$VGMA3 + (VGMA4 - VGMA3) \times 1764 / 1960$
3CH	0 0 1 1 1 1 0 0	VH60	$VGMA3 + (VGMA4 - VGMA3) \times 1813 / 1960$
3DH	0 0 1 1 1 1 0 1	VH61	$VGMA3 + (VGMA4 - VGMA3) \times 1862 / 1960$
3EH	0 0 1 1 1 1 1 0	VH62	$VGMA3 + (VGMA4 - VGMA3) \times 1911 / 1960$
3FH	0 0 1 1 1 1 1 1	VH63	$VGMA4$
40H	0 1 0 0 0 0 0 0	VH64	$VGMA4 + (VGMA5 - VGMA4) \times 49 / 2188$
41H	0 1 0 0 0 0 0 1	VH65	$VGMA4 + (VGMA5 - VGMA4) \times 98 / 2188$
42H	0 1 0 0 0 0 1 0	VH66	$VGMA4 + (VGMA5 - VGMA4) \times 147 / 2188$
43H	0 1 0 0 0 0 1 1	VH67	$VGMA4 + (VGMA5 - VGMA4) \times 196 / 2188$
44H	0 1 0 0 0 1 0 0	VH68	$VGMA4 + (VGMA5 - VGMA4) \times 242 / 2188$
45H	0 1 0 0 0 1 0 1	VH69	$VGMA4 + (VGMA5 - VGMA4) \times 288 / 2188$
46H	0 1 0 0 0 1 1 0	VH70	$VGMA4 + (VGMA5 - VGMA4) \times 334 / 2188$
47H	0 1 0 0 0 1 1 1	VH71	$VGMA4 + (VGMA5 - VGMA4) \times 380 / 2188$
48H	0 1 0 0 1 0 0 0	VH72	$VGMA4 + (VGMA5 - VGMA4) \times 423 / 2188$
49H	0 1 0 0 1 0 0 1	VH73	$VGMA4 + (VGMA5 - VGMA4) \times 466 / 2188$
4AH	0 1 0 0 1 0 1 0	VH74	$VGMA4 + (VGMA5 - VGMA4) \times 509 / 2188$
4BH	0 1 0 0 1 0 1 1	VH75	$VGMA4 + (VGMA5 - VGMA4) \times 552 / 2188$
4CH	0 1 0 0 1 1 0 0	VH76	$VGMA4 + (VGMA5 - VGMA4) \times 592 / 2188$
4DH	0 1 0 0 1 1 0 1	VH77	$VGMA4 + (VGMA5 - VGMA4) \times 632 / 2188$
4EH	0 1 0 0 1 1 1 0	VH78	$VGMA4 + (VGMA5 - VGMA4) \times 672 / 2188$
4FH	0 1 0 0 1 1 1 1	VH79	$VGMA4 + (VGMA5 - VGMA4) \times 712 / 2188$

Table 2. Relationship between Input Data and Output Voltage Value (3)

Input data	DX7 DX6 DX5 DX4 DX3 DX2 DX1 DX0	G/S	Output voltage
50H	0 1 0 1 0 0 0 0	VH80	$VGMA4 + (VGMA5 - VGMA4) \times 750 / 2188$
51H	0 1 0 1 0 0 0 1	VH81	$VGMA4 + (VGMA5 - VGMA4) \times 788 / 2188$
52H	0 1 0 1 0 0 1 0	VH82	$VGMA4 + (VGMA5 - VGMA4) \times 826 / 2188$
53H	0 1 0 1 0 0 1 1	VH83	$VGMA4 + (VGMA5 - VGMA4) \times 864 / 2188$
54H	0 1 0 1 0 1 0 0	VH84	$VGMA4 + (VGMA5 - VGMA4) \times 901 / 2188$
55H	0 1 0 1 0 1 0 1	VH85	$VGMA4 + (VGMA5 - VGMA4) \times 938 / 2188$
56H	0 1 0 1 0 1 1 0	VH86	$VGMA4 + (VGMA5 - VGMA4) \times 975 / 2188$
57H	0 1 0 1 0 1 1 1	VH87	$VGMA4 + (VGMA5 - VGMA4) \times 1012 / 2188$
58H	0 1 0 1 1 0 0 0	VH88	$VGMA4 + (VGMA5 - VGMA4) \times 1047 / 2188$
59H	0 1 0 1 1 0 0 1	VH89	$VGMA4 + (VGMA5 - VGMA4) \times 1082 / 2188$
5AH	0 1 0 1 1 0 1 0	VH90	$VGMA4 + (VGMA5 - VGMA4) \times 1117 / 2188$
5BH	0 1 0 1 1 0 1 1	VH91	$VGMA4 + (VGMA5 - VGMA4) \times 1152 / 2188$
5CH	0 1 0 1 1 1 0 0	VH92	$VGMA4 + (VGMA5 - VGMA4) \times 1186 / 2188$
5DH	0 1 0 1 1 1 0 1	VH93	$VGMA4 + (VGMA5 - VGMA4) \times 1220 / 2188$
5EH	0 1 0 1 1 1 1 0	VH94	$VGMA4 + (VGMA5 - VGMA4) \times 1254 / 2188$
5FH	0 1 0 1 1 1 1 1	VH95	$VGMA4 + (VGMA5 - VGMA4) \times 1288 / 2188$
60H	0 1 1 0 0 0 0 0	VH96	$VGMA4 + (VGMA5 - VGMA4) \times 1320 / 2188$
61H	0 1 1 0 0 0 0 1	VH97	$VGMA4 + (VGMA5 - VGMA4) \times 1352 / 2188$
62H	0 1 1 0 0 0 1 0	VH98	$VGMA4 + (VGMA5 - VGMA4) \times 1384 / 2188$
63H	0 1 1 0 0 0 1 1	VH99	$VGMA4 + (VGMA5 - VGMA4) \times 1416 / 2188$
64H	0 1 1 0 0 1 0 0	VH100	$VGMA4 + (VGMA5 - VGMA4) \times 1447 / 2188$
65H	0 1 1 0 0 1 0 1	VH101	$VGMA4 + (VGMA5 - VGMA4) \times 1478 / 2188$
66H	0 1 1 0 0 1 1 0	VH102	$VGMA4 + (VGMA5 - VGMA4) \times 1509 / 2188$
67H	0 1 1 0 0 1 1 1	VH103	$VGMA4 + (VGMA5 - VGMA4) \times 1540 / 2188$
68H	0 1 1 0 1 0 0 0	VH104	$VGMA4 + (VGMA5 - VGMA4) \times 1569 / 2188$
69H	0 1 1 0 1 0 0 1	VH105	$VGMA4 + (VGMA5 - VGMA4) \times 1598 / 2188$
6AH	0 1 1 0 1 0 1 0	VH106	$VGMA4 + (VGMA5 - VGMA4) \times 1627 / 2188$
6BH	0 1 1 0 1 0 1 1	VH107	$VGMA4 + (VGMA5 - VGMA4) \times 1656 / 2188$
6CH	0 1 1 0 1 1 0 0	VH108	$VGMA4 + (VGMA5 - VGMA4) \times 1684 / 2188$
6DH	0 1 1 0 1 1 0 1	VH109	$VGMA4 + (VGMA5 - VGMA4) \times 1712 / 2188$
6EH	0 1 1 0 1 1 1 0	VH110	$VGMA4 + (VGMA5 - VGMA4) \times 1740 / 2188$
6FH	0 1 1 0 1 1 1 1	VH111	$VGMA4 + (VGMA5 - VGMA4) \times 1768 / 2188$
70H	0 1 1 1 0 0 0 0	VH112	$VGMA4 + (VGMA5 - VGMA4) \times 1796 / 2188$
71H	0 1 1 1 0 0 0 1	VH113	$VGMA4 + (VGMA5 - VGMA4) \times 1824 / 2188$
72H	0 1 1 1 0 0 1 0	VH114	$VGMA4 + (VGMA5 - VGMA4) \times 1852 / 2188$
73H	0 1 1 1 0 0 1 1	VH115	$VGMA4 + (VGMA5 - VGMA4) \times 1880 / 2188$
74H	0 1 1 1 0 1 0 0	VH116	$VGMA4 + (VGMA5 - VGMA4) \times 1906 / 2188$
75H	0 1 1 1 0 1 0 1	VH117	$VGMA4 + (VGMA5 - VGMA4) \times 1932 / 2188$
76H	0 1 1 1 0 1 1 0	VH118	$VGMA4 + (VGMA5 - VGMA4) \times 1958 / 2188$
77H	0 1 1 1 0 1 1 1	VH119	$VGMA4 + (VGMA5 - VGMA4) \times 1984 / 2188$

Table 2. Relationship between Input Data and Output Voltage Value (4)

Input data	DX7	DX6	DX5	DX4	DX3	DX2	DX1	DX0	G/S	Output voltage
78H	0	1	1	1	1	0	0	0	VH120	$VGMA4 + (VGMA5 - VGMA4) \times 2010 / 2188$
79H	0	1	1	1	1	0	0	1	VH121	$VGMA4 + (VGMA5 - VGMA4) \times 2036 / 2188$
7AH	0	1	1	1	1	0	1	0	VH122	$VGMA4 + (VGMA5 - VGMA4) \times 2062 / 2188$
7BH	0	1	1	1	1	0	1	1	VH123	$VGMA4 + (VGMA5 - VGMA4) \times 2088 / 2188$
7CH	0	1	1	1	1	1	0	0	VH124	$VGMA4 + (VGMA5 - VGMA4) \times 2113 / 2188$
7DH	0	1	1	1	1	1	0	1	VH125	$VGMA4 + (VGMA5 - VGMA4) \times 2138 / 2188$
7EH	0	1	1	1	1	1	1	0	VH126	$VGMA4 + (VGMA5 - VGMA4) \times 2163 / 2188$
7FH	0	1	1	1	1	1	1	1	VH127	VGMA5
80H	1	0	0	0	0	0	0	0	VH128	$VGMA5 + (VGMA6 - VGMA5) \times 25 / 2776$
81H	1	0	0	0	0	0	0	1	VH129	$VGMA5 + (VGMA6 - VGMA5) \times 50 / 2776$
82H	1	0	0	0	0	0	1	0	VH130	$VGMA5 + (VGMA6 - VGMA5) \times 75 / 2776$
83H	1	0	0	0	0	0	1	1	VH131	$VGMA5 + (VGMA6 - VGMA5) \times 100 / 2776$
84H	1	0	0	0	0	1	0	0	VH132	$VGMA5 + (VGMA6 - VGMA5) \times 128 / 2776$
85H	1	0	0	0	0	1	0	1	VH133	$VGMA5 + (VGMA6 - VGMA5) \times 156 / 2776$
86H	1	0	0	0	0	1	1	0	VH134	$VGMA5 + (VGMA6 - VGMA5) \times 184 / 2776$
87H	1	0	0	0	0	1	1	1	VH135	$VGMA5 + (VGMA6 - VGMA5) \times 212 / 2776$
88H	1	0	0	0	1	0	0	0	VH136	$VGMA5 + (VGMA6 - VGMA5) \times 243 / 2776$
89H	1	0	0	0	1	0	0	1	VH137	$VGMA5 + (VGMA6 - VGMA5) \times 274 / 2776$
8AH	1	0	0	0	1	0	1	0	VH138	$VGMA5 + (VGMA6 - VGMA5) \times 305 / 2776$
8BH	1	0	0	0	1	0	1	1	VH139	$VGMA5 + (VGMA6 - VGMA5) \times 336 / 2776$
8CH	1	0	0	0	1	1	0	0	VH140	$VGMA5 + (VGMA6 - VGMA5) \times 370 / 2776$
8DH	1	0	0	0	1	1	0	1	VH141	$VGMA5 + (VGMA6 - VGMA5) \times 404 / 2776$
8EH	1	0	0	0	1	1	1	0	VH142	$VGMA5 + (VGMA6 - VGMA5) \times 438 / 2776$
8FH	1	0	0	0	1	1	1	1	VH143	$VGMA5 + (VGMA6 - VGMA5) \times 472 / 2776$
90H	1	0	0	1	0	0	0	0	VH144	$VGMA5 + (VGMA6 - VGMA5) \times 506 / 2776$
91H	1	0	0	1	0	0	0	1	VH145	$VGMA5 + (VGMA6 - VGMA5) \times 540 / 2776$
92H	1	0	0	1	0	0	1	0	VH146	$VGMA5 + (VGMA6 - VGMA5) \times 574 / 2776$
93H	1	0	0	1	0	0	1	1	VH147	$VGMA5 + (VGMA6 - VGMA5) \times 608 / 2776$
94H	1	0	0	1	0	1	0	0	VH148	$VGMA5 + (VGMA6 - VGMA5) \times 645 / 2776$
95H	1	0	0	1	0	1	0	1	VH149	$VGMA5 + (VGMA6 - VGMA5) \times 682 / 2776$
96H	1	0	0	1	0	1	1	0	VH150	$VGMA5 + (VGMA6 - VGMA5) \times 719 / 2776$
97H	1	0	0	1	0	1	1	1	VH151	$VGMA5 + (VGMA6 - VGMA5) \times 756 / 2776$
98H	1	0	0	1	1	0	0	0	VH152	$VGMA5 + (VGMA6 - VGMA5) \times 796 / 2776$
99H	1	0	0	1	1	0	0	1	VH153	$VGMA5 + (VGMA6 - VGMA5) \times 836 / 2776$
9AH	1	0	0	1	1	0	1	0	VH154	$VGMA5 + (VGMA6 - VGMA5) \times 876 / 2776$
9BH	1	0	0	1	1	0	1	1	VH155	$VGMA5 + (VGMA6 - VGMA5) \times 916 / 2776$
9CH	1	0	0	1	1	1	0	0	VH156	$VGMA5 + (VGMA6 - VGMA5) \times 959 / 2776$
9DH	1	0	0	1	1	1	0	1	VH157	$VGMA5 + (VGMA6 - VGMA5) \times 1002 / 2776$
9EH	1	0	0	1	1	1	1	0	VH158	$VGMA5 + (VGMA6 - VGMA5) \times 1045 / 2776$
9FH	1	0	0	1	1	1	1	1	VH159	$VGMA5 + (VGMA6 - VGMA5) \times 1088 / 2776$

Table 2. Relationship between Input Data and Output Voltage Value (5)

Input data	DX7	DX6	DX5	DX4	DX3	DX2	DX1	DX0	G/S	Output voltage
A0H	1	0	1	0	0	0	0	0	VH160	$VGMA5 + (VGMA6 - VGMA5) \times 1131 / 2776$
A1H	1	0	1	0	0	0	0	1	VH161	$VGMA5 + (VGMA6 - VGMA5) \times 1174 / 2776$
A2H	1	0	1	0	0	0	1	0	VH162	$VGMA5 + (VGMA6 - VGMA5) \times 1217 / 2776$
A3H	1	0	1	0	0	0	1	1	VH163	$VGMA5 + (VGMA6 - VGMA5) \times 1260 / 2776$
A4H	1	0	1	0	0	1	0	0	VH164	$VGMA5 + (VGMA6 - VGMA5) \times 1306 / 2776$
A5H	1	0	1	0	0	1	0	1	VH165	$VGMA5 + (VGMA6 - VGMA5) \times 1352 / 2776$
A6H	1	0	1	0	0	1	1	0	VH166	$VGMA5 + (VGMA6 - VGMA5) \times 1398 / 2776$
A7H	1	0	1	0	0	1	1	1	VH167	$VGMA5 + (VGMA6 - VGMA5) \times 1444 / 2776$
A8H	1	0	1	0	1	0	0	0	VH168	$VGMA5 + (VGMA6 - VGMA5) \times 1493 / 2776$
A9H	1	0	1	0	1	0	0	1	VH169	$VGMA5 + (VGMA6 - VGMA5) \times 1542 / 2776$
AAH	1	0	1	0	1	0	1	0	VH170	$VGMA5 + (VGMA6 - VGMA5) \times 1591 / 2776$
ABH	1	0	1	0	1	0	1	1	VH171	$VGMA5 + (VGMA6 - VGMA5) \times 1640 / 2776$
ACH	1	0	1	0	1	1	0	0	VH172	$VGMA5 + (VGMA6 - VGMA5) \times 1692 / 2776$
ADH	1	0	1	0	1	1	0	1	VH173	$VGMA5 + (VGMA6 - VGMA5) \times 1744 / 2776$
AEH	1	0	1	0	1	1	1	0	VH174	$VGMA5 + (VGMA6 - VGMA5) \times 1796 / 2776$
AFH	1	0	1	0	1	1	1	1	VH175	$VGMA5 + (VGMA6 - VGMA5) \times 1848 / 2776$
B0H	1	0	1	1	0	0	0	0	VH176	$VGMA5 + (VGMA6 - VGMA5) \times 1903 / 2776$
B1H	1	0	1	1	0	0	0	1	VH177	$VGMA5 + (VGMA6 - VGMA5) \times 1958 / 2776$
B2H	1	0	1	1	0	0	1	0	VH178	$VGMA5 + (VGMA6 - VGMA5) \times 2013 / 2776$
B3H	1	0	1	1	0	0	1	1	VH179	$VGMA5 + (VGMA6 - VGMA5) \times 2068 / 2776$
B4H	1	0	1	1	0	1	0	0	VH180	$VGMA5 + (VGMA6 - VGMA5) \times 2126 / 2776$
B5H	1	0	1	1	0	1	0	1	VH181	$VGMA5 + (VGMA6 - VGMA5) \times 2184 / 2776$
B6H	1	0	1	1	0	1	1	0	VH182	$VGMA5 + (VGMA6 - VGMA5) \times 2242 / 2776$
B7H	1	0	1	1	0	1	1	1	VH183	$VGMA5 + (VGMA6 - VGMA5) \times 2300 / 2776$
B8H	1	0	1	1	1	0	0	0	VH184	$VGMA5 + (VGMA6 - VGMA5) \times 2358 / 2776$
B9H	1	0	1	1	1	0	0	1	VH185	$VGMA5 + (VGMA6 - VGMA5) \times 2416 / 2776$
BAH	1	0	1	1	1	0	1	0	VH186	$VGMA5 + (VGMA6 - VGMA5) \times 2474 / 2776$
BBH	1	0	1	1	1	0	1	1	VH187	$VGMA5 + (VGMA6 - VGMA5) \times 2532 / 2776$
BCH	1	0	1	1	1	1	0	0	VH188	$VGMA5 + (VGMA6 - VGMA5) \times 2593 / 2776$
BDH	1	0	1	1	1	1	0	1	VH189	$VGMA5 + (VGMA6 - VGMA5) \times 2654 / 2776$
BEH	1	0	1	1	1	1	1	0	VH190	$VGMA5 + (VGMA6 - VGMA5) \times 2715 / 2776$
BFH	1	0	1	1	1	1	1	1	VH191	VGMA6
C0H	1	1	0	0	0	0	0	0	VH192	$VGMA6 + (VGMA7 - VGMA6) \times 61 / 2185$
C1H	1	1	0	0	0	0	0	1	VH193	$VGMA6 + (VGMA7 - VGMA6) \times 122 / 2185$
C2H	1	1	0	0	0	0	1	0	VH194	$VGMA6 + (VGMA7 - VGMA6) \times 183 / 2185$
C3H	1	1	0	0	0	0	1	1	VH195	$VGMA6 + (VGMA7 - VGMA6) \times 244 / 2185$
C4H	1	1	0	0	0	1	0	0	VH196	$VGMA6 + (VGMA7 - VGMA6) \times 308 / 2185$
C5H	1	1	0	0	0	1	0	1	VH197	$VGMA6 + (VGMA7 - VGMA6) \times 372 / 2185$
C6H	1	1	0	0	0	1	1	0	VH198	$VGMA6 + (VGMA7 - VGMA6) \times 436 / 2185$
C7H	1	1	0	0	0	1	1	1	VH199	$VGMA6 + (VGMA7 - VGMA6) \times 500 / 2185$

Table 2. Relationship between Input Data and Output Voltage Value (6)

Input data	DX7	DX6	DX5	DX4	DX3	DX2	DX1	DX0	G/S	Output voltage
C8H	1	1	0	0	1	0	0	0	VH200	$VGMA6 + (VGMA7 - VGMA6) \times 564 / 2185$
C9H	1	1	0	0	1	0	0	1	VH201	$VGMA6 + (VGMA7 - VGMA6) \times 628 / 2185$
CAH	1	1	0	0	1	0	1	0	VH202	$VGMA6 + (VGMA7 - VGMA6) \times 692 / 2185$
CBH	1	1	0	0	1	0	1	1	VH203	$VGMA6 + (VGMA7 - VGMA6) \times 756 / 2185$
CCH	1	1	0	0	1	1	0	0	VH204	$VGMA6 + (VGMA7 - VGMA6) \times 823 / 2185$
CDH	1	1	0	0	1	1	0	1	VH205	$VGMA6 + (VGMA7 - VGMA6) \times 890 / 2185$
CEH	1	1	0	0	1	1	1	0	VH206	$VGMA6 + (VGMA7 - VGMA6) \times 957 / 2185$
CFH	1	1	0	0	1	1	1	1	VH207	$VGMA6 + (VGMA7 - VGMA6) \times 1024 / 2185$
D0H	1	1	0	1	0	0	0	0	VH208	$VGMA6 + (VGMA7 - VGMA6) \times 1091 / 2185$
D1H	1	1	0	1	0	0	0	1	VH209	$VGMA6 + (VGMA7 - VGMA6) \times 1158 / 2185$
D2H	1	1	0	1	0	0	1	0	VH210	$VGMA6 + (VGMA7 - VGMA6) \times 1225 / 2185$
D3H	1	1	0	1	0	0	1	1	VH211	$VGMA6 + (VGMA7 - VGMA6) \times 1292 / 2185$
D4H	1	1	0	1	0	1	0	0	VH212	$VGMA6 + (VGMA7 - VGMA6) \times 1362 / 2185$
D5H	1	1	0	1	0	1	0	1	VH213	$VGMA6 + (VGMA7 - VGMA6) \times 1432 / 2185$
D6H	1	1	0	1	0	1	1	0	VH214	$VGMA6 + (VGMA7 - VGMA6) \times 1502 / 2185$
D7H	1	1	0	1	0	1	1	1	VH215	$VGMA6 + (VGMA7 - VGMA6) \times 1572 / 2185$
D8H	1	1	0	1	1	0	0	0	VH216	$VGMA6 + (VGMA7 - VGMA6) \times 1645 / 2185$
D9H	1	1	0	1	1	0	0	1	VH217	$VGMA6 + (VGMA7 - VGMA6) \times 1718 / 2185$
DAH	1	1	0	1	1	0	1	0	VH218	$VGMA6 + (VGMA7 - VGMA6) \times 1791 / 2185$
DBH	1	1	0	1	1	0	1	1	VH219	$VGMA6 + (VGMA7 - VGMA6) \times 1864 / 2185$
DCH	1	1	0	1	1	1	0	0	VH220	$VGMA6 + (VGMA7 - VGMA6) \times 1938 / 2185$
DDH	1	1	0	1	1	1	0	1	VH221	$VGMA6 + (VGMA7 - VGMA6) \times 2016 / 2185$
DEH	1	1	0	1	1	1	1	0	VH222	$VGMA6 + (VGMA7 - VGMA6) \times 2098 / 2185$
DFH	1	1	0	1	1	1	1	1	VH223	$VGMA7$
E0H	1	1	1	0	0	0	0	0	VH224	$VGMA7 + (VGMA8 - VGMA7) \times 87 / 3336$
E1H	1	1	1	0	0	0	0	1	VH225	$VGMA7 + (VGMA8 - VGMA7) \times 176 / 3336$
E2H	1	1	1	0	0	0	1	0	VH226	$VGMA7 + (VGMA8 - VGMA7) \times 267 / 3336$
E3H	1	1	1	0	0	0	1	1	VH227	$VGMA7 + (VGMA8 - VGMA7) \times 359 / 3336$
E4H	1	1	1	0	0	1	0	0	VH228	$VGMA7 + (VGMA8 - VGMA7) \times 453 / 3336$
E5H	1	1	1	0	0	1	0	1	VH229	$VGMA7 + (VGMA8 - VGMA7) \times 548 / 3336$
E6H	1	1	1	0	0	1	1	0	VH230	$VGMA7 + (VGMA8 - VGMA7) \times 644 / 3336$
E7H	1	1	1	0	0	1	1	1	VH231	$VGMA7 + (VGMA8 - VGMA7) \times 741 / 3336$
E8H	1	1	1	0	1	0	0	0	VH232	$VGMA7 + (VGMA8 - VGMA7) \times 838 / 3336$
E9H	1	1	1	0	1	0	0	1	VH233	$VGMA7 + (VGMA8 - VGMA7) \times 936 / 3336$
EAH	1	1	1	0	1	0	1	0	VH234	$VGMA7 + (VGMA8 - VGMA7) \times 1035 / 3336$
EBH	1	1	1	0	1	0	1	1	VH235	$VGMA7 + (VGMA8 - VGMA7) \times 1135 / 3336$
ECH	1	1	1	0	1	1	0	0	VH236	$VGMA7 + (VGMA8 - VGMA7) \times 1237 / 3336$
EDH	1	1	1	0	1	1	0	1	VH237	$VGMA7 + (VGMA8 - VGMA7) \times 1341 / 3336$
EEH	1	1	1	0	1	1	1	0	VH238	$VGMA7 + (VGMA8 - VGMA7) \times 1445 / 3336$
EFH	1	1	1	0	1	1	1	1	VH239	$VGMA7 + (VGMA8 - VGMA7) \times 1551 / 3336$

Table 2. Relationship between Input Data and Output Voltage Value (7)

Input data	DX7	DX6	DX5	DX4	DX3	DX2	DX1	DX0	G/S	Output voltage
F0H	1	1	1	1	0	0	0	0	VH240	$VGMA7 + (VGMA8 - VGMA7) \times 1659 / 3336$
F1H	1	1	1	1	0	0	0	1	VH241	$VGMA7 + (VGMA8 - VGMA7) \times 1769 / 3336$
F2H	1	1	1	1	0	0	1	0	VH242	$VGMA7 + (VGMA8 - VGMA7) \times 1879 / 3336$
F3H	1	1	1	1	0	0	1	1	VH243	$VGMA7 + (VGMA8 - VGMA7) \times 1991 / 3336$
F4H	1	1	1	1	0	1	0	0	VH244	$VGMA7 + (VGMA8 - VGMA7) \times 2105 / 3336$
F5H	1	1	1	1	0	1	0	1	VH245	$VGMA7 + (VGMA8 - VGMA7) \times 2221 / 3336$
F6H	1	1	1	1	0	1	1	0	VH246	$VGMA7 + (VGMA8 - VGMA7) \times 2339 / 3336$
F7H	1	1	1	1	0	1	1	1	VH247	$VGMA7 + (VGMA8 - VGMA7) \times 2457 / 3336$
F8H	1	1	1	1	1	0	0	0	VH248	$VGMA7 + (VGMA8 - VGMA7) \times 2577 / 3336$
F9H	1	1	1	1	1	0	0	1	VH249	$VGMA7 + (VGMA8 - VGMA7) \times 2697 / 3336$
FAH	1	1	1	1	1	0	1	0	VH250	$VGMA7 + (VGMA8 - VGMA7) \times 2819 / 3336$
FBH	1	1	1	1	1	0	1	1	VH251	$VGMA7 + (VGMA8 - VGMA7) \times 2943 / 3336$
FCH	1	1	1	1	1	1	0	0	VH252	$VGMA7 + (VGMA8 - VGMA7) \times 3070 / 3336$
FDH	1	1	1	1	1	1	0	1	VH253	$VGMA7 + (VGMA8 - VGMA7) \times 3201 / 3336$
FEH	1	1	1	1	1	1	1	0	VH254	VGMA8
FFH	1	1	1	1	1	1	1	1	VH255	VGMA9

Table 2. Relationship between Input Data and Output Voltage Value (8)

Input data	DX7 DX6 DX5 DX4 DX3 DX2 DX1 DX0	G/S	Output voltage
00H	0 0 0 0 0 0 0 0	VL0	VGMA18
01H	0 0 0 0 0 0 0 1	VL1	VGMA17
02H	0 0 0 0 0 0 1 0	VL2	$VGMA17 + (VGMA16 - VGMA17) \times 350 / 4122$
03H	0 0 0 0 0 0 1 1	VL3	$VGMA17 + (VGMA16 - VGMA17) \times 650 / 4122$
04H	0 0 0 0 0 1 0 0	VL4	$VGMA17 + (VGMA16 - VGMA17) \times 915 / 4122$
05H	0 0 0 0 0 1 0 1	VL5	$VGMA17 + (VGMA16 - VGMA17) \times 1155 / 4122$
06H	0 0 0 0 0 1 1 0	VL6	$VGMA17 + (VGMA16 - VGMA17) \times 1375 / 4122$
07H	0 0 0 0 0 1 1 1	VL7	$VGMA17 + (VGMA16 - VGMA17) \times 1577 / 4122$
08H	0 0 0 0 1 0 0 0	VL8	$VGMA17 + (VGMA16 - VGMA17) \times 1764 / 4122$
09H	0 0 0 0 1 0 0 1	VL9	$VGMA17 + (VGMA16 - VGMA17) \times 1938 / 4122$
0AH	0 0 0 0 1 0 1 0	VL10	$VGMA17 + (VGMA16 - VGMA17) \times 2100 / 4122$
0BH	0 0 0 0 1 0 1 1	VL11	$VGMA17 + (VGMA16 - VGMA17) \times 2250 / 4122$
0CH	0 0 0 0 1 1 0 0	VL12	$VGMA17 + (VGMA16 - VGMA17) \times 2390 / 4122$
0DH	0 0 0 0 1 1 0 1	VL13	$VGMA17 + (VGMA16 - VGMA17) \times 2520 / 4122$
0EH	0 0 0 0 1 1 1 0	VL14	$VGMA17 + (VGMA16 - VGMA17) \times 2640 / 4122$
0FH	0 0 0 0 1 1 1 1	VL15	$VGMA17 + (VGMA16 - VGMA17) \times 2750 / 4122$
10H	0 0 0 1 0 0 0 0	VL16	$VGMA17 + (VGMA16 - VGMA17) \times 2855 / 4122$
11H	0 0 0 1 0 0 0 1	VL17	$VGMA17 + (VGMA16 - VGMA17) \times 2955 / 4122$
12H	0 0 0 1 0 0 1 0	VL18	$VGMA17 + (VGMA16 - VGMA17) \times 3040 / 4122$
13H	0 0 0 1 0 0 1 1	VL19	$VGMA17 + (VGMA16 - VGMA17) \times 3132 / 4122$
14H	0 0 0 1 0 1 0 0	VL20	$VGMA17 + (VGMA16 - VGMA17) \times 3221 / 4122$
15H	0 0 0 1 0 1 0 1	VL21	$VGMA17 + (VGMA16 - VGMA17) \times 3307 / 4122$
16H	0 0 0 1 0 1 1 0	VL22	$VGMA17 + (VGMA16 - VGMA17) \times 3390 / 4122$
17H	0 0 0 1 0 1 1 1	VL23	$VGMA17 + (VGMA16 - VGMA17) \times 3472 / 4122$
18H	0 0 0 1 1 0 0 0	VL24	$VGMA17 + (VGMA16 - VGMA17) \times 3553 / 4122$
19H	0 0 0 1 1 0 0 1	VL25	$VGMA17 + (VGMA16 - VGMA17) \times 3634 / 4122$
1AH	0 0 0 1 1 0 1 0	VL26	$VGMA17 + (VGMA16 - VGMA17) \times 3715 / 4122$
1BH	0 0 0 1 1 0 1 1	VL27	$VGMA17 + (VGMA16 - VGMA17) \times 3796 / 4122$
1CH	0 0 0 1 1 1 0 0	VL28	$VGMA17 + (VGMA16 - VGMA17) \times 3875 / 4122$
1DH	0 0 0 1 1 1 0 1	VL29	$VGMA17 + (VGMA16 - VGMA17) \times 3944 / 4122$
1EH	0 0 0 1 1 1 1 0	VL30	$VGMA17 + (VGMA16 - VGMA17) \times 4023 / 4122$
1FH	0 0 0 1 1 1 1 1	VL31	VGMA16
20H	0 0 1 0 0 0 0 0	VL32	$VGMA16 + (VGMA15 - VGMA16) \times 78 / 1960$
21H	0 0 1 0 0 0 0 1	VL33	$VGMA16 + (VGMA15 - VGMA16) \times 156 / 1960$
22H	0 0 1 0 0 0 1 0	VL34	$VGMA16 + (VGMA15 - VGMA16) \times 234 / 1960$
23H	0 0 1 0 0 0 1 1	VL35	$VGMA16 + (VGMA15 - VGMA16) \times 312 / 1960$
24H	0 0 1 0 0 1 0 0	VL36	$VGMA16 + (VGMA15 - VGMA16) \times 383 / 1960$
25H	0 0 1 0 0 1 0 1	VL37	$VGMA16 + (VGMA15 - VGMA16) \times 454 / 1960$
26H	0 0 1 0 0 1 1 0	VL38	$VGMA16 + (VGMA15 - VGMA16) \times 525 / 1960$
27H	0 0 1 0 0 1 1 1	VL39	$VGMA16 + (VGMA15 - VGMA16) \times 596 / 1960$

NOTE: VSS2<VGMA18<VGMA17<VGMA16<VGMA15<VGMA14<VGMA13<VGMA12<VGMA11<VGMA10

Table 2. Relationship between Input Data and Output Voltage Value (9)

Input data	DX7 DX6 DX5 DX4 DX3 DX2 DX1 DX0	G/S	Output voltage
28H	0 0 1 0 1 0 0 0	VL40	$VGMA16 + (VGMA15 - VGMA16) \times 662 / 1960$
29H	0 0 1 0 1 0 0 1	VL41	$VGMA16 + (VGMA15 - VGMA16) \times 728 / 1960$
2AH	0 0 1 0 1 0 1 0	VL42	$VGMA16 + (VGMA15 - VGMA16) \times 794 / 1960$
2BH	0 0 1 0 1 0 1 1	VL43	$VGMA16 + (VGMA15 - VGMA16) \times 860 / 1960$
2CH	0 0 1 0 1 1 0 0	VL44	$VGMA16 + (VGMA15 - VGMA16) \times 921 / 1960$
2DH	0 0 1 0 1 1 0 1	VL45	$VGMA16 + (VGMA15 - VGMA16) \times 982 / 1960$
2EH	0 0 1 0 1 1 1 0	VL46	$VGMA16 + (VGMA15 - VGMA16) \times 1043 / 1960$
2FH	0 0 1 0 1 1 1 1	VL47	$VGMA16 + (VGMA15 - VGMA16) \times 1104 / 1960$
30H	0 0 1 1 0 0 0 0	VL48	$VGMA16 + (VGMA15 - VGMA16) \times 1162 / 1960$
31H	0 0 1 1 0 0 0 1	VL49	$VGMA16 + (VGMA15 - VGMA16) \times 1220 / 1960$
32H	0 0 1 1 0 0 1 0	VL50	$VGMA16 + (VGMA15 - VGMA16) \times 1278 / 1960$
33H	0 0 1 1 0 0 1 1	VL51	$VGMA16 + (VGMA15 - VGMA16) \times 1336 / 1960$
34H	0 0 1 1 0 1 0 0	VL52	$VGMA16 + (VGMA15 - VGMA16) \times 1391 / 1960$
35H	0 0 1 1 0 1 0 1	VL53	$VGMA16 + (VGMA15 - VGMA16) \times 1446 / 1960$
36H	0 0 1 1 0 1 1 0	VL54	$VGMA16 + (VGMA15 - VGMA16) \times 1501 / 1960$
37H	0 0 1 1 0 1 1 1	VL55	$VGMA16 + (VGMA15 - VGMA16) \times 1556 / 1960$
38H	0 0 1 1 1 0 0 0	VL56	$VGMA16 + (VGMA15 - VGMA16) \times 1608 / 1960$
39H	0 0 1 1 1 0 0 1	VL57	$VGMA16 + (VGMA15 - VGMA16) \times 1660 / 1960$
3AH	0 0 1 1 1 0 1 0	VL58	$VGMA16 + (VGMA15 - VGMA16) \times 1712 / 1960$
3BH	0 0 1 1 1 0 1 1	VL59	$VGMA16 + (VGMA15 - VGMA16) \times 1764 / 1960$
3CH	0 0 1 1 1 1 0 0	VL60	$VGMA16 + (VGMA15 - VGMA16) \times 1813 / 1960$
3DH	0 0 1 1 1 1 0 1	VL61	$VGMA16 + (VGMA15 - VGMA16) \times 1862 / 1960$
3EH	0 0 1 1 1 1 1 0	VL62	$VGMA16 + (VGMA15 - VGMA16) \times 1911 / 1960$
3FH	0 0 1 1 1 1 1 1	VL63	$VGMA15$
40H	0 1 0 0 0 0 0 0	VL64	$VGMA15 + (VGMA14 - VGMA15) \times 49 / 2188$
41H	0 1 0 0 0 0 0 1	VL65	$VGMA15 + (VGMA14 - VGMA15) \times 98 / 2188$
42H	0 1 0 0 0 0 1 0	VL66	$VGMA15 + (VGMA14 - VGMA15) \times 147 / 2188$
43H	0 1 0 0 0 0 1 1	VL67	$VGMA15 + (VGMA14 - VGMA15) \times 196 / 2188$
44H	0 1 0 0 0 1 0 0	VL68	$VGMA15 + (VGMA14 - VGMA15) \times 242 / 2188$
45H	0 1 0 0 0 1 0 1	VL69	$VGMA15 + (VGMA14 - VGMA15) \times 288 / 2188$
46H	0 1 0 0 0 1 1 0	VL70	$VGMA15 + (VGMA14 - VGMA15) \times 334 / 2188$
47H	0 1 0 0 0 1 1 1	VL71	$VGMA15 + (VGMA14 - VGMA15) \times 380 / 2188$
48H	0 1 0 0 1 0 0 0	VL72	$VGMA15 + (VGMA14 - VGMA15) \times 423 / 2188$
49H	0 1 0 0 1 0 0 1	VL73	$VGMA15 + (VGMA14 - VGMA15) \times 466 / 2188$
4AH	0 1 0 0 1 0 1 0	VL74	$VGMA15 + (VGMA14 - VGMA15) \times 509 / 2188$
4BH	0 1 0 0 1 0 1 1	VL75	$VGMA15 + (VGMA14 - VGMA15) \times 552 / 2188$
4CH	0 1 0 0 1 1 0 0	VL76	$VGMA15 + (VGMA14 - VGMA15) \times 592 / 2188$
4DH	0 1 0 0 1 1 0 1	VL77	$VGMA15 + (VGMA14 - VGMA15) \times 632 / 2188$
4EH	0 1 0 0 1 1 1 0	VL78	$VGMA15 + (VGMA14 - VGMA15) \times 672 / 2188$
4FH	0 1 0 0 1 1 1 1	VL79	$VGMA15 + (VGMA14 - VGMA15) \times 712 / 2188$

Table 2. Relationship between Input Data and Output Voltage Value (10)

Input data	DX7 DX6 DX5 DX4 DX3 DX2 DX1 DX0	G/S	Output voltage
50H	0 1 0 1 0 0 0 0	VL80	$VGMA15 + (VGMA14 - VGMA15) \times 750 / 2188$
51H	0 1 0 1 0 0 0 1	VL81	$VGMA15 + (VGMA14 - VGMA15) \times 788 / 2188$
52H	0 1 0 1 0 0 1 0	VL82	$VGMA15 + (VGMA14 - VGMA15) \times 826 / 2188$
53H	0 1 0 1 0 0 1 1	VL83	$VGMA15 + (VGMA14 - VGMA15) \times 864 / 2188$
54H	0 1 0 1 0 1 0 0	VL84	$VGMA15 + (VGMA14 - VGMA15) \times 901 / 2188$
55H	0 1 0 1 0 1 0 1	VL85	$VGMA15 + (VGMA14 - VGMA15) \times 938 / 2188$
56H	0 1 0 1 0 1 1 0	VL86	$VGMA15 + (VGMA14 - VGMA15) \times 975 / 2188$
57H	0 1 0 1 0 1 1 1	VL87	$VGMA15 + (VGMA14 - VGMA15) \times 1012 / 2188$
58H	0 1 0 1 1 0 0 0	VL88	$VGMA15 + (VGMA14 - VGMA15) \times 1047 / 2188$
59H	0 1 0 1 1 0 0 1	VL89	$VGMA15 + (VGMA14 - VGMA15) \times 1082 / 2188$
5AH	0 1 0 1 1 0 1 0	VL90	$VGMA15 + (VGMA14 - VGMA15) \times 1117 / 2188$
5BH	0 1 0 1 1 0 1 1	VL91	$VGMA15 + (VGMA14 - VGMA15) \times 1152 / 2188$
5CH	0 1 0 1 1 1 0 0	VL92	$VGMA15 + (VGMA14 - VGMA15) \times 1186 / 2188$
5DH	0 1 0 1 1 1 0 1	VL93	$VGMA15 + (VGMA14 - VGMA15) \times 1220 / 2188$
5EH	0 1 0 1 1 1 1 0	VL94	$VGMA15 + (VGMA14 - VGMA15) \times 1254 / 2188$
5FH	0 1 0 1 1 1 1 1	VL95	$VGMA15 + (VGMA14 - VGMA15) \times 1288 / 2188$
60H	0 1 1 0 0 0 0 0	VL96	$VGMA15 + (VGMA14 - VGMA15) \times 1320 / 2188$
61H	0 1 1 0 0 0 0 1	VL97	$VGMA15 + (VGMA14 - VGMA15) \times 1352 / 2188$
62H	0 1 1 0 0 0 1 0	VL98	$VGMA15 + (VGMA14 - VGMA15) \times 1384 / 2188$
63H	0 1 1 0 0 0 1 1	VL99	$VGMA15 + (VGMA14 - VGMA15) \times 1416 / 2188$
64H	0 1 1 0 0 1 0 0	VL100	$VGMA15 + (VGMA14 - VGMA15) \times 1447 / 2188$
65H	0 1 1 0 0 1 0 1	VL101	$VGMA15 + (VGMA14 - VGMA15) \times 1478 / 2188$
66H	0 1 1 0 0 1 1 0	VL102	$VGMA15 + (VGMA14 - VGMA15) \times 1509 / 2188$
67H	0 1 1 0 0 1 1 1	VL103	$VGMA15 + (VGMA14 - VGMA15) \times 1540 / 2188$
68H	0 1 1 0 1 0 0 0	VL104	$VGMA15 + (VGMA14 - VGMA15) \times 1569 / 2188$
69H	0 1 1 0 1 0 0 1	VL105	$VGMA15 + (VGMA14 - VGMA15) \times 1598 / 2188$
6AH	0 1 1 0 1 0 1 0	VL106	$VGMA15 + (VGMA14 - VGMA15) \times 1627 / 2188$
6BH	0 1 1 0 1 0 1 1	VL107	$VGMA15 + (VGMA14 - VGMA15) \times 1656 / 2188$
6CH	0 1 1 0 1 1 0 0	VL108	$VGMA15 + (VGMA14 - VGMA15) \times 1684 / 2188$
6DH	0 1 1 0 1 1 0 1	VL109	$VGMA15 + (VGMA14 - VGMA15) \times 1712 / 2188$
6EH	0 1 1 0 1 1 1 0	VL110	$VGMA15 + (VGMA14 - VGMA15) \times 1740 / 2188$
6FH	0 1 1 0 1 1 1 1	VL111	$VGMA15 + (VGMA14 - VGMA15) \times 1768 / 2188$
70H	0 1 1 1 0 0 0 0	VL112	$VGMA15 + (VGMA14 - VGMA15) \times 1796 / 2188$
71H	0 1 1 1 0 0 0 1	VL113	$VGMA15 + (VGMA14 - VGMA15) \times 1824 / 2188$
72H	0 1 1 1 0 0 1 0	VL114	$VGMA15 + (VGMA14 - VGMA15) \times 1852 / 2188$
73H	0 1 1 1 0 0 1 1	VL115	$VGMA15 + (VGMA14 - VGMA15) \times 1880 / 2188$
74H	0 1 1 1 0 1 0 0	VL116	$VGMA15 + (VGMA14 - VGMA15) \times 1906 / 2188$
75H	0 1 1 1 0 1 0 1	VL117	$VGMA15 + (VGMA14 - VGMA15) \times 1932 / 2188$
76H	0 1 1 1 0 1 1 0	VL118	$VGMA15 + (VGMA14 - VGMA15) \times 1958 / 2188$
77H	0 1 1 1 0 1 1 1	VL119	$VGMA15 + (VGMA14 - VGMA15) \times 1984 / 2188$

Table 2. Relationship between Input Data and Output Voltage Value (11)

Input data	DX7 DX6 DX5 DX4 DX3 DX2 DX1 DX0	G/S	Output voltage
78H	0 1 1 1 1 0 0 0	VL120	$VGMA15 + (VGMA14 - VGMA15) \times 2010 / 2188$
79H	0 1 1 1 1 0 0 1	VL121	$VGMA15 + (VGMA14 - VGMA15) \times 2036 / 2188$
7AH	0 1 1 1 1 0 1 0	VL122	$VGMA15 + (VGMA14 - VGMA15) \times 2062 / 2188$
7BH	0 1 1 1 1 0 1 1	VL123	$VGMA15 + (VGMA14 - VGMA15) \times 2088 / 2188$
7CH	0 1 1 1 1 1 0 0	VL124	$VGMA15 + (VGMA14 - VGMA15) \times 2113 / 2188$
7DH	0 1 1 1 1 1 0 1	VL125	$VGMA15 + (VGMA14 - VGMA15) \times 2138 / 2188$
7EH	0 1 1 1 1 1 1 0	VL126	$VGMA15 + (VGMA14 - VGMA15) \times 2163 / 2188$
7FH	0 1 1 1 1 1 1 1	VL127	VGMA14
80H	1 0 0 0 0 0 0 0	VL128	$VGMA14 + (VGMA13 - VGMA14) \times 25 / 2776$
81H	1 0 0 0 0 0 0 1	VL129	$VGMA14 + (VGMA13 - VGMA14) \times 50 / 2776$
82H	1 0 0 0 0 0 1 0	VL130	$VGMA14 + (VGMA13 - VGMA14) \times 75 / 2776$
83H	1 0 0 0 0 0 1 1	VL131	$VGMA14 + (VGMA13 - VGMA14) \times 100 / 2776$
84H	1 0 0 0 0 1 0 0	VL132	$VGMA14 + (VGMA13 - VGMA14) \times 128 / 2776$
85H	1 0 0 0 0 1 0 1	VL133	$VGMA14 + (VGMA13 - VGMA14) \times 156 / 2776$
86H	1 0 0 0 0 1 1 0	VL134	$VGMA14 + (VGMA13 - VGMA14) \times 184 / 2776$
87H	1 0 0 0 0 1 1 1	VL135	$VGMA14 + (VGMA13 - VGMA14) \times 212 / 2776$
88H	1 0 0 0 1 0 0 0	VL136	$VGMA14 + (VGMA13 - VGMA14) \times 243 / 2776$
89H	1 0 0 0 1 0 0 1	VL137	$VGMA14 + (VGMA13 - VGMA14) \times 274 / 2776$
8AH	1 0 0 0 1 0 1 0	VL138	$VGMA14 + (VGMA13 - VGMA14) \times 305 / 2776$
8BH	1 0 0 0 1 0 1 1	VL139	$VGMA14 + (VGMA13 - VGMA14) \times 336 / 2776$
8CH	1 0 0 0 1 1 0 0	VL140	$VGMA14 + (VGMA13 - VGMA14) \times 370 / 2776$
8DH	1 0 0 0 1 1 0 1	VL141	$VGMA14 + (VGMA13 - VGMA14) \times 404 / 2776$
8EH	1 0 0 0 1 1 1 0	VL142	$VGMA14 + (VGMA13 - VGMA14) \times 438 / 2776$
8FH	1 0 0 0 1 1 1 1	VL143	$VGMA14 + (VGMA13 - VGMA14) \times 472 / 2776$
90H	1 0 0 1 0 0 0 0	VL144	$VGMA14 + (VGMA13 - VGMA14) \times 506 / 2776$
91H	1 0 0 1 0 0 0 1	VL145	$VGMA14 + (VGMA13 - VGMA14) \times 540 / 2776$
92H	1 0 0 1 0 0 1 0	VL146	$VGMA14 + (VGMA13 - VGMA14) \times 574 / 2776$
93H	1 0 0 1 0 0 1 1	VL147	$VGMA14 + (VGMA13 - VGMA14) \times 608 / 2776$
94H	1 0 0 1 0 1 0 0	VL148	$VGMA14 + (VGMA13 - VGMA14) \times 645 / 2776$
95H	1 0 0 1 0 1 0 1	VL149	$VGMA14 + (VGMA13 - VGMA14) \times 682 / 2776$
96H	1 0 0 1 0 1 1 0	VL150	$VGMA14 + (VGMA13 - VGMA14) \times 719 / 2776$
97H	1 0 0 1 0 1 1 1	VL151	$VGMA14 + (VGMA13 - VGMA14) \times 756 / 2776$
98H	1 0 0 1 1 0 0 0	VL152	$VGMA14 + (VGMA13 - VGMA14) \times 796 / 2776$
99H	1 0 0 1 1 0 0 1	VL153	$VGMA14 + (VGMA13 - VGMA14) \times 836 / 2776$
9AH	1 0 0 1 1 0 1 0	VL154	$VGMA14 + (VGMA13 - VGMA14) \times 876 / 2776$
9BH	1 0 0 1 1 0 1 1	VL155	$VGMA14 + (VGMA13 - VGMA14) \times 916 / 2776$
9CH	1 0 0 1 1 1 0 0	VL156	$VGMA14 + (VGMA13 - VGMA14) \times 959 / 2776$
9DH	1 0 0 1 1 1 0 1	VL157	$VGMA14 + (VGMA13 - VGMA14) \times 1002 / 2776$
9EH	1 0 0 1 1 1 1 0	VL158	$VGMA14 + (VGMA13 - VGMA14) \times 1045 / 2776$
9FH	1 0 0 1 1 1 1 1	VL159	$VGMA14 + (VGMA13 - VGMA14) \times 1088 / 2776$

Table 2. Relationship between Input Data and Output Voltage Value (12)

Input data	DX7 DX6 DX5 DX4 DX3 DX2 DX1 DX0	G/S	Output voltage
A0H	1 0 1 0 0 0 0 0	VL160	$VGMA14 + (VGMA13 - VGMA14) \times 1131 / 2776$
A1H	1 0 1 0 0 0 0 1	VL161	$VGMA14 + (VGMA13 - VGMA14) \times 1174 / 2776$
A2H	1 0 1 0 0 0 1 0	VL162	$VGMA14 + (VGMA13 - VGMA14) \times 1217 / 2776$
A3H	1 0 1 0 0 0 1 1	VL163	$VGMA14 + (VGMA13 - VGMA14) \times 1260 / 2776$
A4H	1 0 1 0 0 1 0 0	VL164	$VGMA14 + (VGMA13 - VGMA14) \times 1306 / 2776$
A5H	1 0 1 0 0 1 0 1	VL165	$VGMA14 + (VGMA13 - VGMA14) \times 1352 / 2776$
A6H	1 0 1 0 0 1 1 0	VL166	$VGMA14 + (VGMA13 - VGMA14) \times 1398 / 2776$
A7H	1 0 1 0 0 1 1 1	VL167	$VGMA14 + (VGMA13 - VGMA14) \times 1444 / 2776$
A8H	1 0 1 0 1 0 0 0	VL168	$VGMA14 + (VGMA13 - VGMA14) \times 1493 / 2776$
A9H	1 0 1 0 1 0 0 1	VL169	$VGMA14 + (VGMA13 - VGMA14) \times 1542 / 2776$
AAH	1 0 1 0 1 0 1 0	VL170	$VGMA14 + (VGMA13 - VGMA14) \times 1591 / 2776$
ABH	1 0 1 0 1 0 1 1	VL171	$VGMA14 + (VGMA13 - VGMA14) \times 1640 / 2776$
ACH	1 0 1 0 1 1 0 0	VL172	$VGMA14 + (VGMA13 - VGMA14) \times 1692 / 2776$
ADH	1 0 1 0 1 1 0 1	VL173	$VGMA14 + (VGMA13 - VGMA14) \times 1744 / 2776$
AEH	1 0 1 0 1 1 1 0	VL174	$VGMA14 + (VGMA13 - VGMA14) \times 1796 / 2776$
AFH	1 0 1 0 1 1 1 1	VL175	$VGMA14 + (VGMA13 - VGMA14) \times 1848 / 2776$
B0H	1 0 1 1 0 0 0 0	VL176	$VGMA14 + (VGMA13 - VGMA14) \times 1903 / 2776$
B1H	1 0 1 1 0 0 0 1	VL177	$VGMA14 + (VGMA13 - VGMA14) \times 1958 / 2776$
B2H	1 0 1 1 0 0 1 0	VL178	$VGMA14 + (VGMA13 - VGMA14) \times 2013 / 2776$
B3H	1 0 1 1 0 0 1 1	VL179	$VGMA14 + (VGMA13 - VGMA14) \times 2068 / 2776$
B4H	1 0 1 1 0 1 0 0	VL180	$VGMA14 + (VGMA13 - VGMA14) \times 2126 / 2776$
B5H	1 0 1 1 0 1 0 1	VL181	$VGMA14 + (VGMA13 - VGMA14) \times 2184 / 2776$
B6H	1 0 1 1 0 1 1 0	VL182	$VGMA14 + (VGMA13 - VGMA14) \times 2242 / 2776$
B7H	1 0 1 1 0 1 1 1	VL183	$VGMA14 + (VGMA13 - VGMA14) \times 2300 / 2776$
B8H	1 0 1 1 1 0 0 0	VL184	$VGMA14 + (VGMA13 - VGMA14) \times 2358 / 2776$
B9H	1 0 1 1 1 0 0 1	VL185	$VGMA14 + (VGMA13 - VGMA14) \times 2416 / 2776$
BAH	1 0 1 1 1 0 1 0	VL186	$VGMA14 + (VGMA13 - VGMA14) \times 2474 / 2776$
BBH	1 0 1 1 1 0 1 1	VL187	$VGMA14 + (VGMA13 - VGMA14) \times 2532 / 2776$
BCH	1 0 1 1 1 1 0 0	VL188	$VGMA14 + (VGMA13 - VGMA14) \times 2593 / 2776$
BDH	1 0 1 1 1 1 0 1	VL189	$VGMA14 + (VGMA13 - VGMA14) \times 2654 / 2776$
BEH	1 0 1 1 1 1 1 0	VL190	$VGMA14 + (VGMA13 - VGMA14) \times 2715 / 2776$
BFH	1 0 1 1 1 1 1 1	VL191	$VGMA13$
C0H	1 1 0 0 0 0 0 0	VL192	$VGMA13 + (VGMA12 - VGMA13) \times 61 / 2185$
C1H	1 1 0 0 0 0 0 1	VL193	$VGMA13 + (VGMA12 - VGMA13) \times 122 / 2185$
C2H	1 1 0 0 0 0 1 0	VL194	$VGMA13 + (VGMA12 - VGMA13) \times 183 / 2185$
C3H	1 1 0 0 0 0 1 1	VL195	$VGMA13 + (VGMA12 - VGMA13) \times 244 / 2185$
C4H	1 1 0 0 0 1 0 0	VL196	$VGMA13 + (VGMA12 - VGMA13) \times 308 / 2185$
C5H	1 1 0 0 0 1 0 1	VL197	$VGMA13 + (VGMA12 - VGMA13) \times 372 / 2185$
C6H	1 1 0 0 0 1 1 0	VL198	$VGMA13 + (VGMA12 - VGMA13) \times 436 / 2185$
C7H	1 1 0 0 0 1 1 1	VL199	$VGMA13 + (VGMA12 - VGMA13) \times 500 / 2185$

Table 2. Relationship between Input Data and Output Voltage Value (13)

Input data	DX7 DX6 DX5 DX4 DX3 DX2 DX1 DX0	G/S	Output voltage
C8H	1 1 0 0 1 0 0 0	VL200	$VGMA13 + (VGMA12 - VGMA13) \times 564 / 2185$
C9H	1 1 0 0 1 0 0 1	VL201	$VGMA13 + (VGMA12 - VGMA13) \times 628 / 2185$
CAH	1 1 0 0 1 0 1 0	VL202	$VGMA13 + (VGMA12 - VGMA13) \times 692 / 2185$
CBH	1 1 0 0 1 0 1 1	VL203	$VGMA13 + (VGMA12 - VGMA13) \times 756 / 2185$
CCH	1 1 0 0 1 1 0 0	VL204	$VGMA13 + (VGMA12 - VGMA13) \times 823 / 2185$
CDH	1 1 0 0 1 1 0 1	VL205	$VGMA13 + (VGMA12 - VGMA13) \times 890 / 2185$
CEH	1 1 0 0 1 1 1 0	VL206	$VGMA13 + (VGMA12 - VGMA13) \times 957 / 2185$
CFH	1 1 0 0 1 1 1 1	VL207	$VGMA13 + (VGMA12 - VGMA13) \times 1024 / 2185$
D0H	1 1 0 1 0 0 0 0	VL208	$VGMA13 + (VGMA12 - VGMA13) \times 1091 / 2185$
D1H	1 1 0 1 0 0 0 1	VL209	$VGMA13 + (VGMA12 - VGMA13) \times 1158 / 2185$
D2H	1 1 0 1 0 0 1 0	VL210	$VGMA13 + (VGMA12 - VGMA13) \times 1225 / 2185$
D3H	1 1 0 1 0 0 1 1	VL211	$VGMA13 + (VGMA12 - VGMA13) \times 1292 / 2185$
D4H	1 1 0 1 0 1 0 0	VL212	$VGMA13 + (VGMA12 - VGMA13) \times 1362 / 2185$
D5H	1 1 0 1 0 1 0 1	VL213	$VGMA13 + (VGMA12 - VGMA13) \times 1432 / 2185$
D6H	1 1 0 1 0 1 1 0	VL214	$VGMA13 + (VGMA12 - VGMA13) \times 1502 / 2185$
D7H	1 1 0 1 0 1 1 1	VL215	$VGMA13 + (VGMA12 - VGMA13) \times 1572 / 2185$
D8H	1 1 0 1 1 0 0 0	VL216	$VGMA13 + (VGMA12 - VGMA13) \times 1645 / 2185$
D9H	1 1 0 1 1 0 0 1	VL217	$VGMA13 + (VGMA12 - VGMA13) \times 1718 / 2185$
DAH	1 1 0 1 1 0 1 0	VL218	$VGMA13 + (VGMA12 - VGMA13) \times 1791 / 2185$
DBH	1 1 0 1 1 0 1 1	VL219	$VGMA13 + (VGMA12 - VGMA13) \times 1864 / 2185$
DCH	1 1 0 1 1 1 0 0	VL220	$VGMA13 + (VGMA12 - VGMA13) \times 1938 / 2185$
DDH	1 1 0 1 1 1 0 1	VL221	$VGMA13 + (VGMA12 - VGMA13) \times 2016 / 2185$
DEH	1 1 0 1 1 1 1 0	VL222	$VGMA13 + (VGMA12 - VGMA13) \times 2098 / 2185$
DFH	1 1 0 1 1 1 1 1	VL223	$VGMA12$
E0H	1 1 1 0 0 0 0 0	VL224	$VGMA12 + (VGMA11 - VGMA12) \times 87 / 3336$
E1H	1 1 1 0 0 0 0 1	VL225	$VGMA12 + (VGMA11 - VGMA12) \times 176 / 3336$
E2H	1 1 1 0 0 0 1 0	VL226	$VGMA12 + (VGMA11 - VGMA12) \times 267 / 3336$
E3H	1 1 1 0 0 0 1 1	VL227	$VGMA12 + (VGMA11 - VGMA12) \times 359 / 3336$
E4H	1 1 1 0 0 1 0 0	VL228	$VGMA12 + (VGMA11 - VGMA12) \times 453 / 3336$
E5H	1 1 1 0 0 1 0 1	VL229	$VGMA12 + (VGMA11 - VGMA12) \times 548 / 3336$
E6H	1 1 1 0 0 1 1 0	VL230	$VGMA12 + (VGMA11 - VGMA12) \times 644 / 3336$
E7H	1 1 1 0 0 1 1 1	VL231	$VGMA12 + (VGMA11 - VGMA12) \times 741 / 3336$
E8H	1 1 1 0 1 0 0 0	VL232	$VGMA12 + (VGMA11 - VGMA12) \times 838 / 3336$
E9H	1 1 1 0 1 0 0 1	VL233	$VGMA12 + (VGMA11 - VGMA12) \times 936 / 3336$
EAH	1 1 1 0 1 0 1 0	VL234	$VGMA12 + (VGMA11 - VGMA12) \times 1035 / 3336$
EBH	1 1 1 0 1 0 1 1	VL235	$VGMA12 + (VGMA11 - VGMA12) \times 1135 / 3336$
ECH	1 1 1 0 1 1 0 0	VL236	$VGMA12 + (VGMA11 - VGMA12) \times 1237 / 3336$
EDH	1 1 1 0 1 1 0 1	VL237	$VGMA12 + (VGMA11 - VGMA12) \times 1341 / 3336$
EEH	1 1 1 0 1 1 1 0	VL238	$VGMA12 + (VGMA11 - VGMA12) \times 1445 / 3336$
EFH	1 1 1 0 1 1 1 1	VL239	$VGMA12 + (VGMA11 - VGMA12) \times 1551 / 3336$

Table 2. Relationship between Input Data and Output Voltage Value (14)

Input data	DX7	DX6	DX5	DX4	DX3	DX2	DX1	DX0	G/S	Output voltage
F0H	1	1	1	1	0	0	0	0	VL240	$VGMA12 + (VGMA11 - VGMA12) \times 1659 / 3336$
F1H	1	1	1	1	0	0	0	1	VL241	$VGMA12 + (VGMA11 - VGMA12) \times 1769 / 3336$
F2H	1	1	1	1	0	0	1	0	VL242	$VGMA12 + (VGMA11 - VGMA12) \times 1879 / 3336$
F3H	1	1	1	1	0	0	1	1	VL243	$VGMA12 + (VGMA11 - VGMA12) \times 1991 / 3336$
F4H	1	1	1	1	0	1	0	0	VL244	$VGMA12 + (VGMA11 - VGMA12) \times 2105 / 3336$
F5H	1	1	1	1	0	1	0	1	VL245	$VGMA12 + (VGMA11 - VGMA12) \times 2221 / 3336$
F6H	1	1	1	1	0	1	1	0	VL246	$VGMA12 + (VGMA11 - VGMA12) \times 2339 / 3336$
F7H	1	1	1	1	0	1	1	1	VL247	$VGMA12 + (VGMA11 - VGMA12) \times 2457 / 3336$
F8H	1	1	1	1	1	0	0	0	VL248	$VGMA12 + (VGMA11 - VGMA12) \times 2577 / 3336$
F9H	1	1	1	1	1	0	0	1	VL249	$VGMA12 + (VGMA11 - VGMA12) \times 2697 / 3336$
FAH	1	1	1	1	1	0	1	0	VL250	$VGMA12 + (VGMA11 - VGMA12) \times 2819 / 3336$
FBH	1	1	1	1	1	0	1	1	VL251	$VGMA12 + (VGMA11 - VGMA12) \times 2943 / 3336$
FCH	1	1	1	1	1	1	0	0	VL252	$VGMA12 + (VGMA11 - VGMA12) \times 3070 / 3336$
FDH	1	1	1	1	1	1	0	1	VL253	$VGMA12 + (VGMA11 - VGMA12) \times 3201 / 3336$
FEH	1	1	1	1	1	1	1	0	VL254	VGMA11
FFH	1	1	1	1	1	1	1	1	VL255	VGMA10

ABSOLUTE MAXIMUM RATINGS

Table 3. Absolute Maximum Ratings (VSS1 = VSS2 = 0 V)

Parameter	Symbol	Ratings	Unit
Logic supply voltage	VDD1	-0.3 to 5.0	V
Driver supply voltage	VDD2	-0.3 to 16.0	V
Input voltage	VGMA1 - 18	-0.3 to VDD2+0.3	V
	Others	-0.3 to VDD1+0.3	
Output voltage	DIO1, 2	-0.3 to VDD1+0.3	V
	Y1 – Y384	-0.3 to VDD2+0.3	
Operating power dissipation	Pd	300 ⁽¹⁾	mW
Operation temperature	Top	-20 to 75	°C
Storage temperature	Tstg	-55 to 125	°C

CAUTIONS:

If LSIs are stressed beyond those listed above “absolute maximum ratings”, they may be permanently destroyed. These are stress ratings only, and functional operation of the device at these or any other condition beyond those indicated under “recommended operating conditions” is not implied. Exposure to absolute maximum rated conditions for extended periods may affect device reliability.

Turn on power order: VDD1 → control signal input → VDD2 → VGMA1 to VGMA18

Turn off power order: VGMA1 to VGMA18 → VDD2 → control signal input → VDD1

RECOMMENDED OPERATION CONDITIONS

Table 4. Recommended Operation Conditions (Ta = -20 to 75 °C, VSS1 = VSS2 = 0 V)

Parameter	Symbol	Min.	Typ.	Max.	Unit
Logic supply voltage	VDD1	2.7	3.3	3.6	V
Driver supply voltage	VDD2 ⁽¹⁾	8.0	12.0	15.0	V
Gamma corrected voltage	VGMA1 – VGMA9	0.5 VDD2	-	VDD2 - 0.1	V
	VGMA10 – VGMA18	VSS2 + 0.1	-	0.5 VDD2	V
Driver part output voltage	Vyo	VSS2 + 0.1	-	VDD2 - 0.1	V
Maximum clock frequency	fmax	VDD1 = 2.7 V		65	MHz
Output load capacitance	CL ⁽¹⁾	-	-	200	pF / PIN

NOTE: 1. Relationship between TFT-LCD panel and Pd ($Pd \propto CL * (VDD2)^2 * fCLK1$)

TFT-LCD panel standard	CL = 140pF	CL = 200pF
SXGA	max. VDD2 = 15 V	max. VDD2 = 13 V

DC CHARACTERISTICS

Table 5. DC Characteristics (Ta = -20 to 75 °C, VDD1 = 2.7 to 3.6 V, VDD2 = 8 to 15 V, VSS1 = VSS2 = 0 V)

Parameter	Symbol	Condition	Min.	Typ.	Max.	Unit
High level input voltage	VIH	SHL, CLK2, D00 - D57, CLK1, DATPOL1, DATPOL2, POL, DIO1 (DIO2)	0.8 VDD1	-	VDD1	V
Low level input voltage	VIL		0	-	0.2 VDD1	
Input leakage current	IL		-1	-	1	μA
High level output voltage	VOH	DIO1 (DIO2), IO = -1.0 mA	VDD1 - 0.5	-	-	V
Low level output voltage	VOL	DIO1 (DIO2), IO = +1.0 mA	-	-	0.5	
Resistor	R0 - R254	Refer to Table 1. Resistor Strings	Rn × 0.7		Rn × 1.3	Ω
Driver output current	I _{VOH}	VDD2 = 10.0 V, V _x = 3.5 V, V _{yo} = 9.5 V ⁽¹⁾	-	-2.0	-1.0	mA
	I _{VOL}	VDD2 = 10.0 V, V _x = 6.5 V, V _{yo} = 0.5 V ⁽¹⁾	1.0	2.0	-	
Output voltage deviation	ΔVO	VSS2 + 0.1 V to VDD2 - 1.5 V	-	±7	±15	mV
		VDD2 - 1.5 V to VDD2 - 0.1 V	-	±10	±20	
Output RMS voltage deviation	dV _{rms} ⁽²⁾	Input data: 00H to FFH	-	±3	±10	
Output voltage range	V _{yo}	Input data: 00H to FFH	VSS2 + 0.1	-	VDD2 - 0.1	V
Logic part dynamic current	IDD1	VDD1 = 3.0 V ⁽³⁾	-	4.0	7.0	mA
Driver part dynamic current	IDD2	VDD2 = 10 V ⁽⁴⁾	-	10.0	15.0	

NOTES:

- V_{yo} is the output voltage of analog output pins Y1 to Y384.
V_x is the voltage applied to analog output pins Y1 to Y384.
- dV_{rms} is a maximum deviation value from ideal difference between high output and low output at the same gray scale.
- CLK1 period is defined to be 15.6 μs at fCLK2 = 54 MHz, data pattern = 10101010 (checkerboard pattern), Ta = 25 °C.
- Yout Load Condition

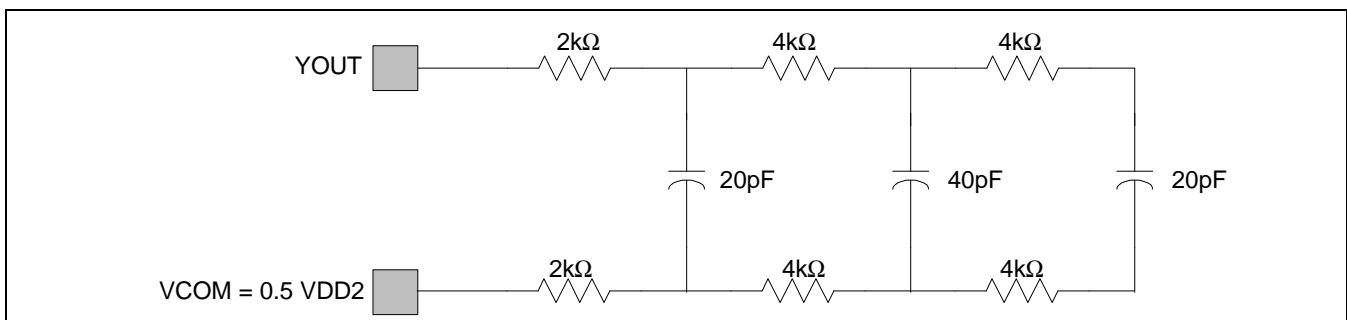

Figure 5. Yout Load Condition

AC CHARACTERISTICS

Table 6. AC Characteristics (Ta = -20 to 75 °C, VDD1 = 2.7 to 3.6 V ,VDD2 = 8 to 15 V, VSS1 = VSS2 = 0 V)

Parameter	Symbol	Condition	Min.	Typ.	Max.	Unit
Clock pulse width	PWCLK	-	15	-	-	ns
Clock pulse low period	PWCLK(L)	-	3	-	-	
Clock pulse high period	PWCLK(H)	-	3	-	-	
Data setup time	tSETUP1	-	0	-	-	
Data hold time	tHOLD1	-	2	-	-	
Start pulse setup time	tSETUP2	-	0	-	-	
Start pulse hold time	tHOLD2	-	2	-	-	
DATPOL-CLK2 setup time	tSETUP4	-	0	-	-	
DATPOL-CLK2 hold time	tHOLD4	-	2	-	-	
Start pulse delay time	tPLH1	CL = 20 pF	-	-	12	
CLK1 setup time	tSETUP3	-	2	-	-	CLK2 period
Driver output delay time1	tPHL1	PWCLK1 = 1 μs, Refer Figure 5. Yout Load Condition	-	-	4	μs
Driver output delay time2	tPHL2		-	-	8	
CLK1 pulse high period	PWCLK1	-	(3CLK2)	-	2	CLK2 period
Data invalid period	tINV	-	1	-	-	
Last data timing	tLDT	-	1	-	-	
CLK1-CLK2 time	tCLK1-CLK2	CLK1↑ or ↓ → CLK2↑	7	-	-	ns
POL-CLK1 time	tPOL-CLK1	POL↑ or ↓ → CLK1↑	7	-	-	ns

WAVEFORMS ($V_{IH} = 0.8 V_{DD1}$, $V_{IL} = 0.2 V_{DD1}$)

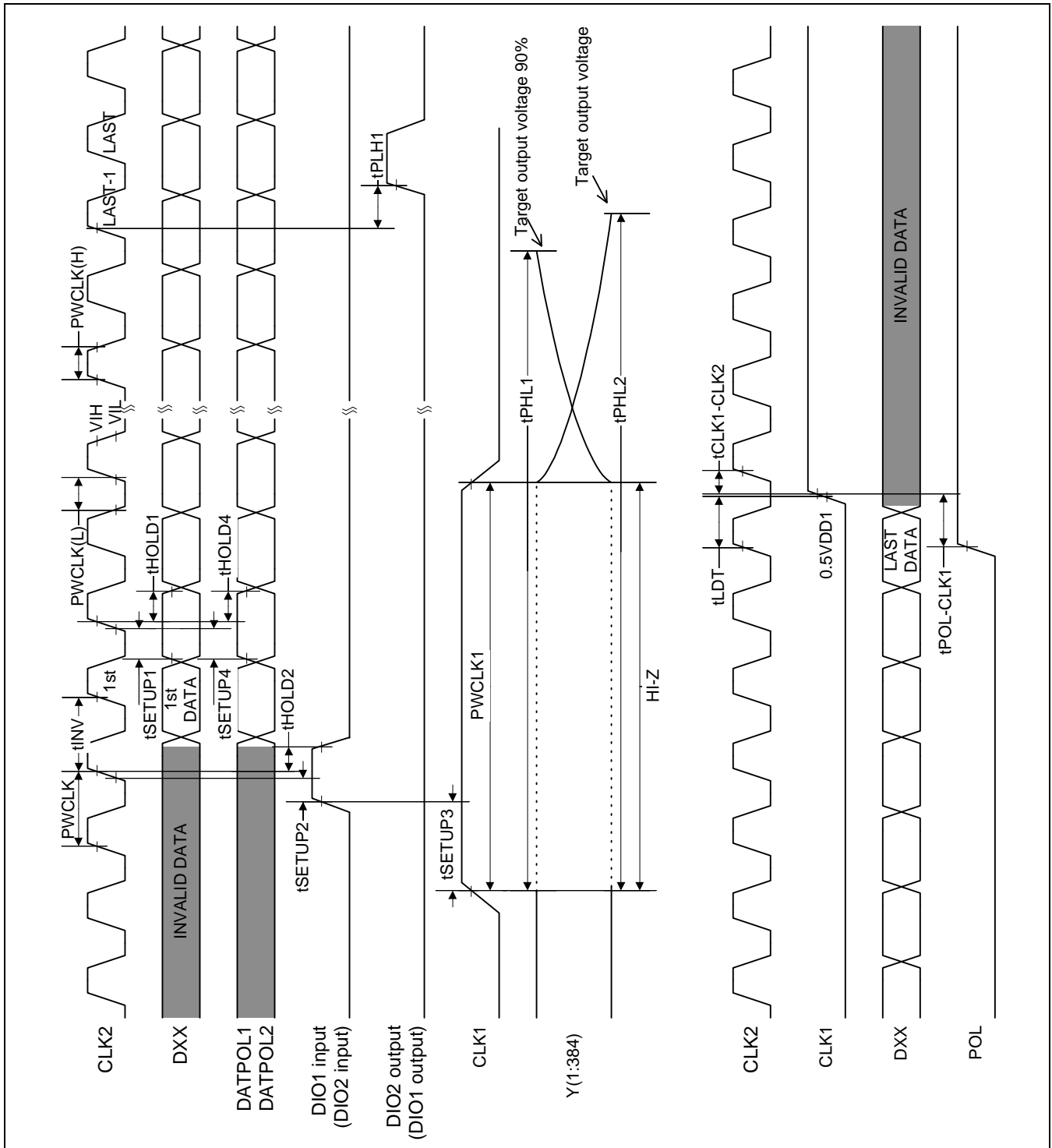

Figure 6. Waveforms, DEC = L

RELATIONSHIPS BETWEEN CLK1, START PULSE (DIO1, DIO2) AND BLANKING PERIOD

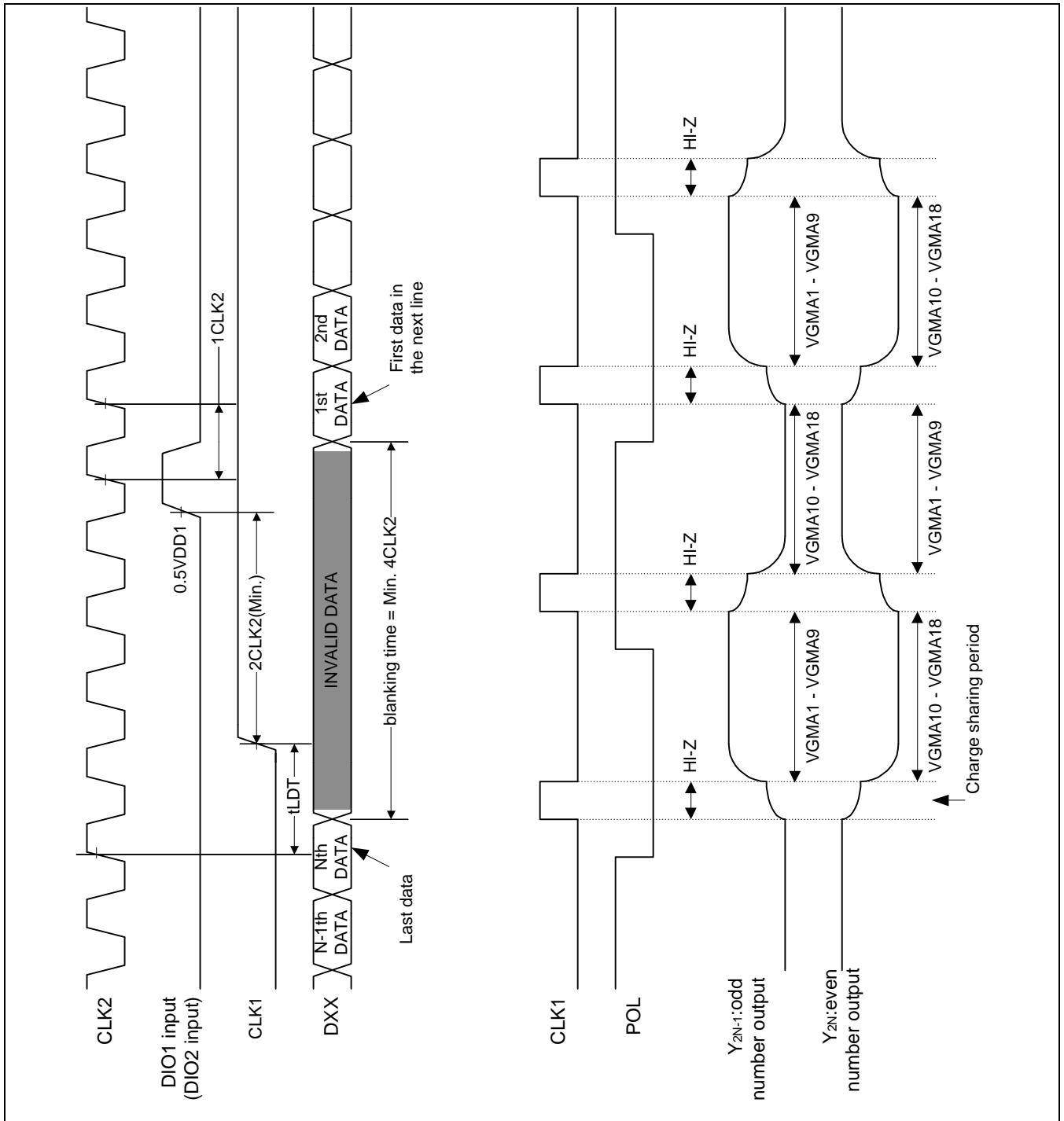

Figure 7. Waveforms