

## Description

- As Control Circuit of Battery-Backed Memory
- As Measure Against Erroneous Operations at Power On-Off
- As Resetting Function for the CPU-Mounted Equipment --- PC, Printer, VTR, Fax, C-TV etc.
- As Measure Against System Runaway at Instantaneous Break of Power Supply etc.

## Features

- Current Consumption is Low ( $I_{CCL}=300 \mu A$  Typ.  $I_{CCH}=30 \mu A$  Typ.)
- Resetting Output Minimum Guarantee Voltage is Low (0.8V Typ.)
- Hysteresis Voltage is Provided (50 mV Typ.)

## Ordering Information

Type NO.	Marking	Package Code
S7131SF	731	SOT-23F

## Outline Dimensions

unit : mm

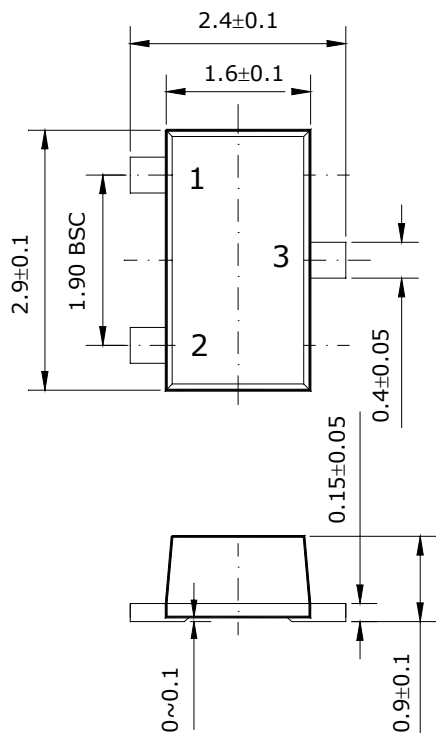

## Equivalent Circuit

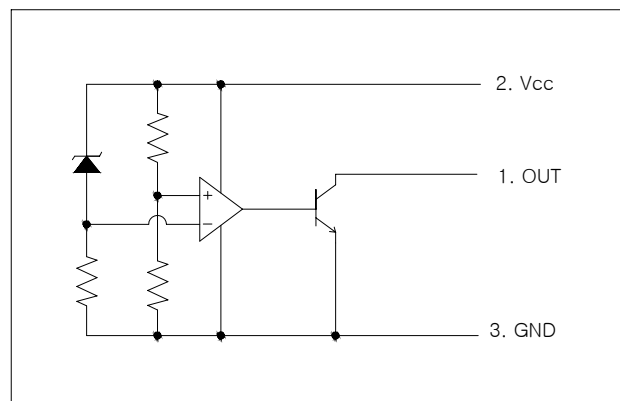

## PIN Connections

1. Out
2. Vcc
3. GND

## Absolute maximum ratings

(Ta=25°C)

Characteristic	Symbol	Ratings	Unit
Supply voltage	V <sub>CC</sub>	-0.3 ~ +15	V
Power Dissipation (Package Limitation)	P <sub>D</sub> *	300	mW
Operating Temperature	T <sub>opr</sub>	-30 ~ +75	°C
Storage Temperature	T <sub>stg</sub>	-55 ~ +150	°C

\* With PCB(8×8 mm Copper Area) at Glass Epoxy Board (t=1.7 mm, Area; 20×20 mm)

## Electrical Characteristics

(Ta=25°C)

Characteristic	Symbol	Test Circuit	Test Condition	Min.	Typ.	Max.	Unit
Detecting voltage	V <sub>S</sub>	1	R <sub>L</sub> =200Ω, V <sub>OL</sub> ≤0.4V	2.95	3.1	3.25	V
Low Level Output voltage	V <sub>OL</sub>	1	R <sub>L</sub> =200Ω	-	-	0.4	V
Output Leakage Current	I <sub>OH</sub>	1	V <sub>CC</sub> =15V	-	-	0.1	μA
Hysteresis Voltage	ΔV <sub>S</sub>	1	R <sub>L</sub> =200Ω	30	50	100	mV
Detecting Voltage Temperature Coefficient	V <sub>S</sub> /ΔT	1	R <sub>L</sub> =200Ω	-	±0.01	-	%/°C
Circuit current at on Time	I <sub>CCL</sub>	1	V <sub>CC</sub> = V <sub>Smin</sub> - 0.05V	-	300	500	μA
Circuit current at off Time	I <sub>CCH</sub>	1	V <sub>CC</sub> =5.25V	-	30	50	μA
Threshold Operating Voltage	V <sub>opr</sub>	1	R <sub>L</sub> =200Ω, V <sub>OL</sub> ≤0.4V	-	0.8	-	V
'L' Transmission Delay Time	t <sub>pHL</sub>	2	R <sub>L</sub> =1.0 kΩ, C <sub>L</sub> =100 pF	-	10	-	μs
'H' Transmission Delay Time	t <sub>pLH</sub>	2	R <sub>L</sub> =1.0 kΩ, C <sub>L</sub> =100 pF	-	15	-	μs
Output Current at on Time I	I <sub>OL I</sub>	1	V <sub>CC</sub> = V <sub>Smin</sub> - 0.05V Ta = 25°C	20	-	-	mA
Output Current at on Time II	I <sub>OL II</sub>	1	V <sub>CC</sub> = V <sub>Smin</sub> - 0.05V Ta = -30~+75°C	16	-	-	mA

**Test Circuit 1**

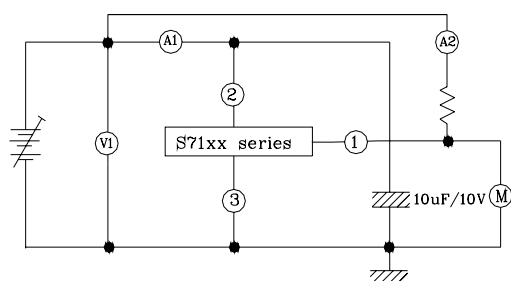

**Test Circuit 2**

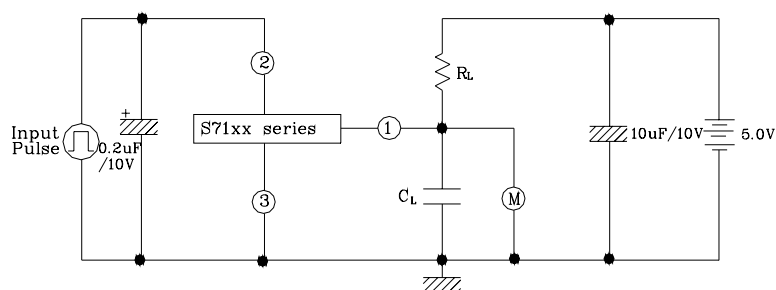

Electrical Characteristic Curves

Fig. 1  $V_{OUT} - V_{CC}$

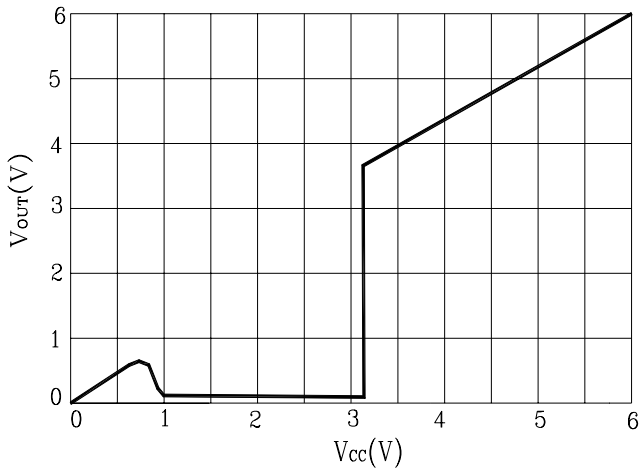

Fig. 2  $I_{CC} - V_{CC}$

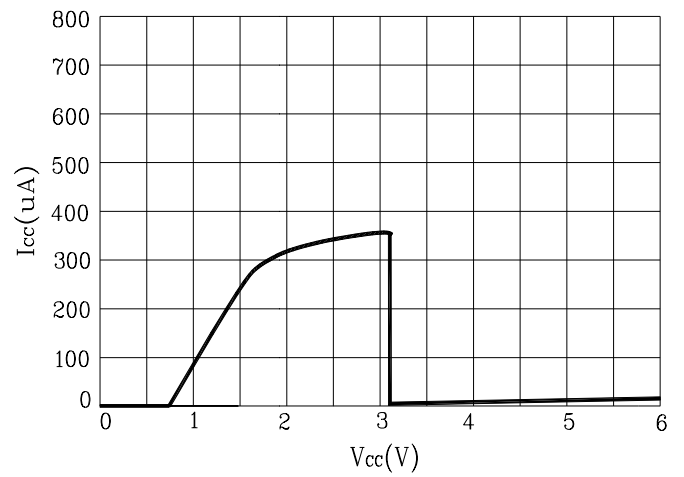

Fig. 3  $I_{CCH} - Temp$

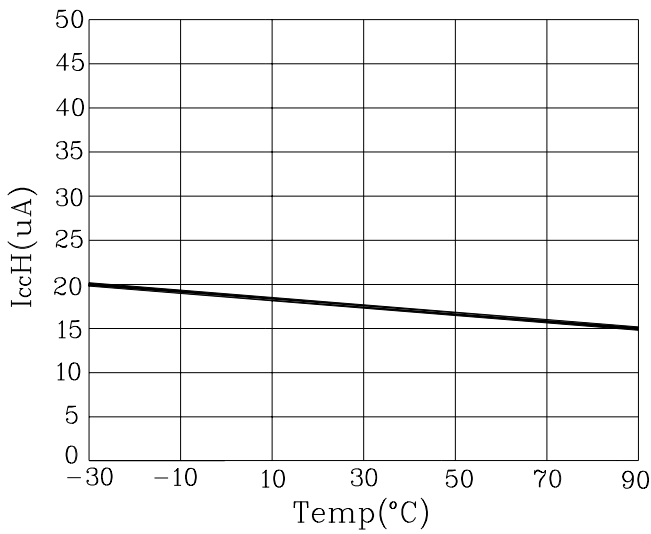

Fig. 4  $I_{OL} - R_L$

