

Description

- As Control Circuit of Battery-Backed Memory
- As Measure Against Erroneous Operations at Power On-Off
- As Resetting Function for the CPU-Mounted Equipment --- PC, Printer, VTR, Fax, C-TV etc.
- As Measure Against System Runaway at Instantaneous Break of Power Supply etc.

Features

- Current Consumption is Low ($I_{CC L} = 300 \mu A$ Typ. $I_{CC H} = 30 \mu A$ Typ.)
- Resetting Output Minimum Guarantee Voltage is Low (0.8V Typ.)
- Hysteresis Voltage is Provided (50 mV Typ.)

Ordering Information

Type NO.	Marking	Package Code
S7139SF	739	SOT-23F

Outline Dimensions

unit : mm

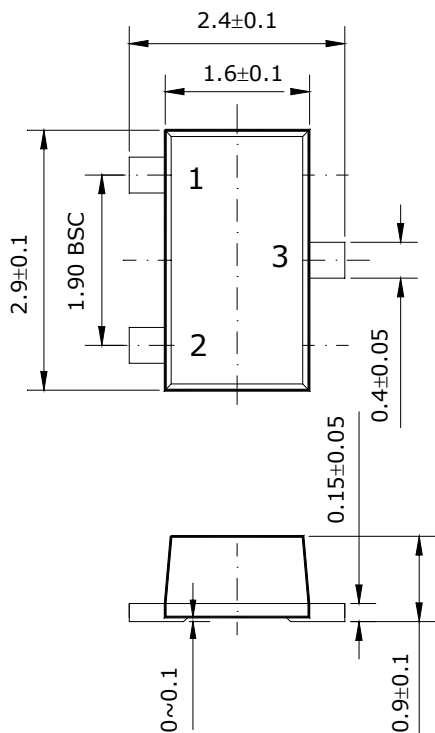

Equivalent Circuit

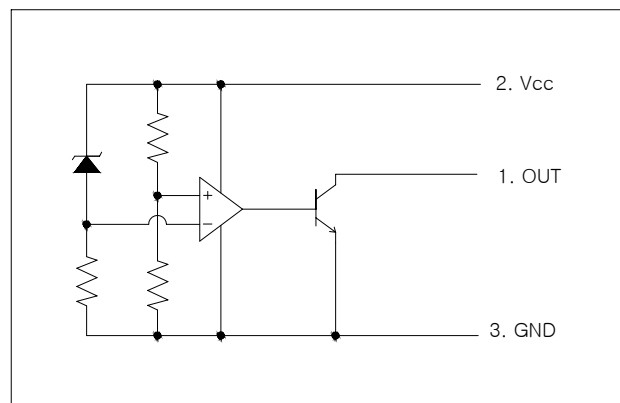

PIN Connections

1. Out
2. Vcc
3. GND

Absolute maximum ratings

(Ta=25°C)

Characteristic	Symbol	Ratings	Unit
Supply voltage	V_{CC}	-0.3 ~ +15	V
Power Dissipation (Package Limitation)	P_D^*	300	mW
Operating Temperature	T_{opr}	-30 ~ +75	°C
Storage Temperature	T_{stg}	-55 ~ +150	°C

* With PCB(8×8 mm Copper Area) at Glass Epoxy Board (t=1.7 mm, Area; 20×20 mm)

Electrical Characteristics

(Ta=25°C)

Characteristic	Symbol	Test Circuit	Test Condition	Min.	Typ.	Max.	Unit
Detecting voltage	V_S	1	$R_L=200\Omega, V_{OL}\leq 0.4V$	3.75	3.9	4.05	V
Low Level Output voltage	V_{OL}	1	$R_L=200\Omega$	-	-	0.4	V
Output Leakage Current	I_{OH}	1	$V_{CC}=15V$	-	-	0.1	μA
Hysteresis Voltage	ΔV_S	1	$R_L=200\Omega$	30	50	100	mV
Detecting Voltage Temperature Coefficient	$V_S/\Delta T$	1	$R_L=200\Omega$	-	±0.01	-	%/°C
Circuit current at on Time	I_{CCL}	1	$V_{CC} = V_{Smin} - 0.05V$	-	300	500	μA
Circuit current at off Time	I_{CCH}	1	$V_{CC}=5.25V$	-	30	50	μA
Threshold Operating Voltage	V_{opr}	1	$R_L=200\Omega, V_{OL}\leq 0.4V$	-	0.8	-	V
'L' Transmission Delay Time	t_{pHL}	2	$R_L=1.0\text{ k}\Omega, C_L=100\text{ pF}$	-	10	-	μs
'H' Transmission Delay Time	t_{pLH}	2	$R_L=1.0\text{ k}\Omega, C_L=100\text{ pF}$	-	15	-	μs
Output Current at on Time I	I_{OLI}	1	$V_{CC} = V_{Smin} - 0.05V$ $T_a = 25^\circ C$	20	-	-	mA
Output Current at on Time II	I_{OLII}	1	$V_{CC} = V_{Smin} - 0.05V$ $T_a = -30\sim+75^\circ C$	16	-	-	mA

Test Circuit 1

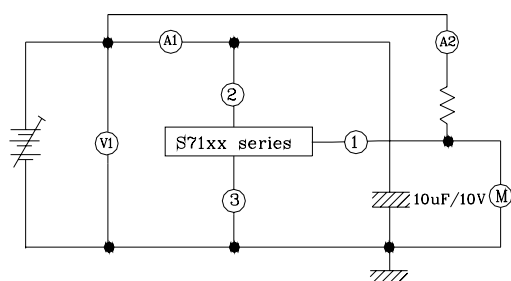

Test Circuit 2

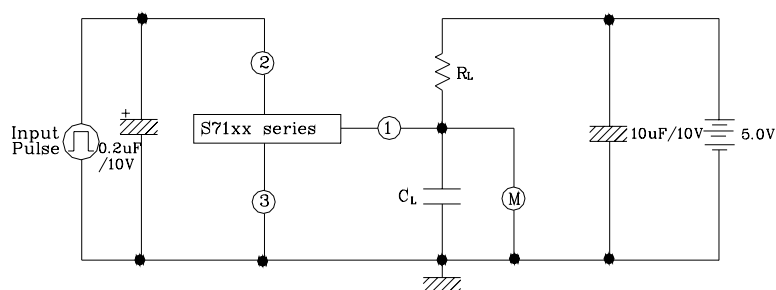

Electrical Characteristic Curves

Fig. 1 $V_{OUT} - V_{CC}$

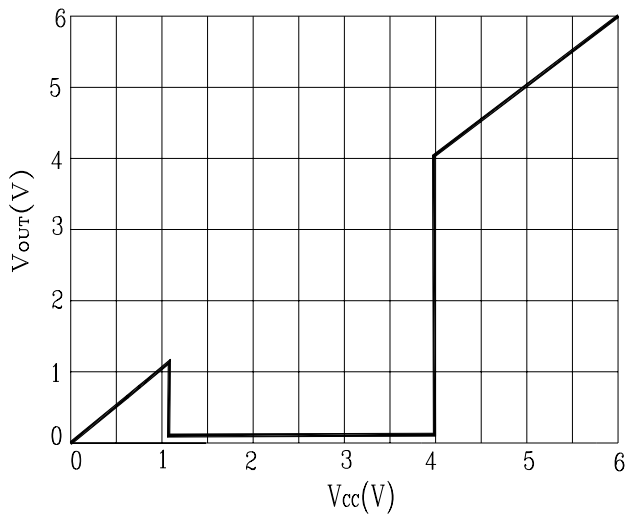

Fig. 2 $I_{CC} - V_{CC}$

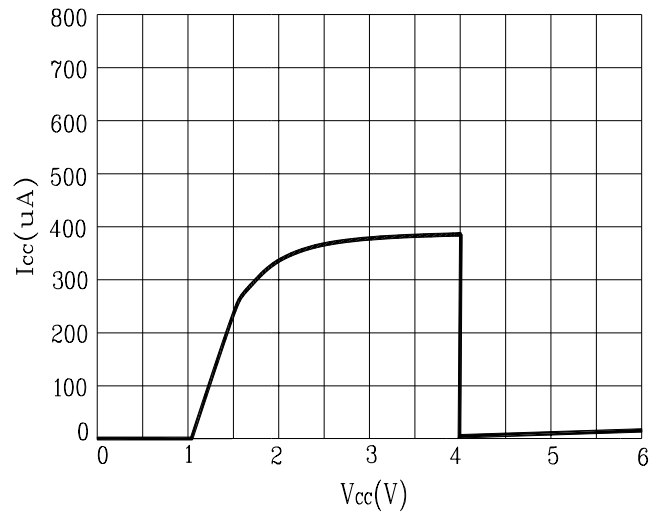

Fig. 3 $I_{CCH} - Temp$

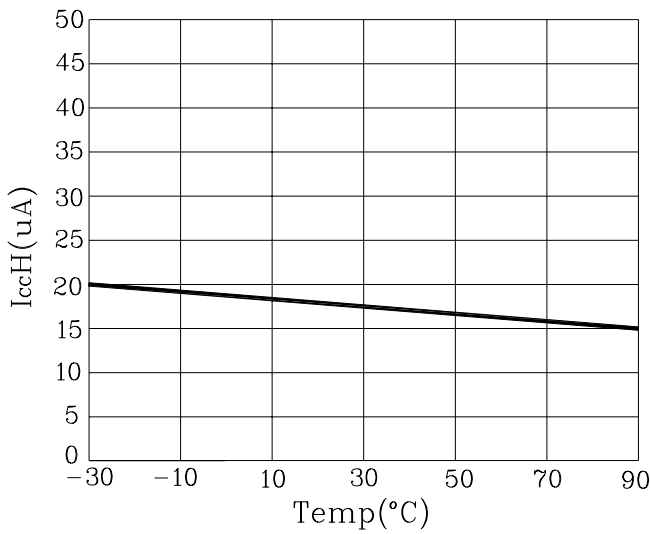

Fig. 4 $I_{OL} - R_L$

