

## 80C186EA/80C188EA AND 80L186EA/80L188EA 16-BIT HIGH-INTEGRATION EMBEDDED PROCESSORS

- 80C186 Upgrade for Power Critical Applications
  - Fully Static Operation
  - True CMOS Inputs and Outputs
- Integrated Feature Set
  - Static 186 CPU Core
  - Power Save, Idle and Powerdown Modes
  - Clock Generator
  - 2 Independent DMA Channels
  - 3 Programmable 16-Bit Timers
  - Dynamic RAM Refresh Control Unit
  - Programmable Memory and Peripheral Chip Select Logic
  - Programmable Wait State Generator
  - Local Bus Controller
  - System-Level Testing Support (High Impedance Test Mode)
- Speed Versions Available (5V):
  - 25 MHz (80C186EA25/80C188EA25)
  - 20 MHz (80C186EA20/80C188EA20)
  - 13 MHz (80C186EA13/80C188EA13)
- Speed Versions Available (3V):
  - 13 MHz (80L186EA13/80L188EA13)
  - 8 MHz (80L186EA8/80L188EA8)
- Direct Addressing Capability to 1 Mbyte Memory and 64 Kbyte I/O
- Supports 80C187 Numeric Coprocessor Interface (80C186EA only)
- Available in the Following Packages:
  - 68-Pin Plastic Leaded Chip Carrier (PLCC)
  - 80-Pin EIAJ Quad Flat Pack (QFP)
  - 80-Pin Shrink Quad Flat Pack (SQFP)
- Available in Extended Temperature Range (-40°C to +85°C)

The 80C186EA is a CHMOS high integration embedded microprocessor. The 80C186EA includes all of the features of an "Enhanced Mode" 80C186 while adding the additional capabilities of Idle and Powerdown Modes. In Numerics Mode, the 80C186EA interfaces directly with an 80C187 Numerics Coprocessor.

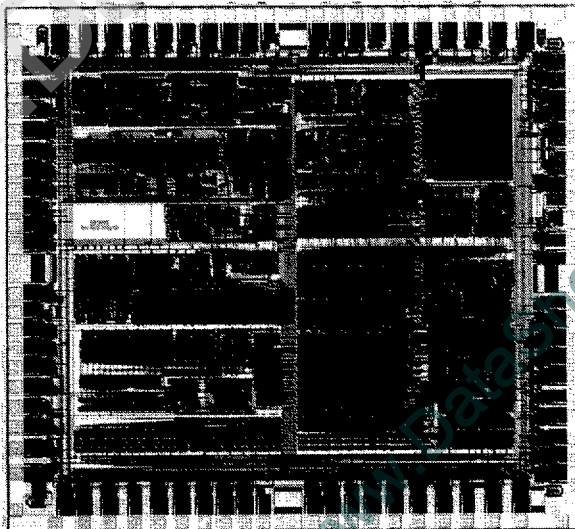

272432-1



# 80C186EA/80C188EA AND 80L186EA/80L188EA 16-Bit High Integration Embedded Processor

<b>CONTENTS</b>	<b>PAGE</b>
<b>INTRODUCTION</b> .....	1-85
<b>80C186EA CORE ARCHITECTURE</b> .....	1-85
Bus Interface Unit .....	1-85
Clock Generator .....	1-85
<b>80C186EA PERIPHERAL ARCHITECTURE</b> .....	1-86
Interrupt Control Unit .....	1-86
Timer/Counter Unit .....	1-86
DMA Control Unit .....	1-88
Chip-Select Unit .....	1-88
Refresh Control Unit .....	1-88
Power Management .....	1-88
80C187 Interface (80C186EA Only) .....	1-89
ONCE Test Mode .....	1-89
<b>DIFFERENCES BETWEEN THE 80C186XL AND THE 80C186EA</b> .....	1-89
Pinout Compatibility .....	1-89
Operating Modes .....	1-89
TTL vs CMOS Inputs .....	1-89
Timing Specifications .....	1-89
<b>PACKAGE INFORMATION</b> .....	1-90
Prefix Identification .....	1-90
Pin Descriptions .....	1-90
80C186EA Pinout .....	1-96

<b>CONTENTS</b>	<b>PAGE</b>
<b>PACKAGE THERMAL SPECIFICATIONS</b> .....	1-101
<b>ELECTRICAL SPECIFICATIONS</b> .....	1-102
Absolute Maximum Ratings .....	1-102
Recommended Connections .....	1-102
<b>DC SPECIFICATIONS</b> .....	1-103
I <sub>CC</sub> versus Frequency and Voltage .....	1-105
PDTMR Pin Delay Calculation .....	1-105
<b>AC SPECIFICATIONS</b> .....	1-106
AC Characteristics—80C186EA20/13 ..	1-106
AC Characteristics—80L186EA13/8 ..	1-108
Relative Timings .....	1-110
<b>AC TEST CONDITIONS</b> .....	1-111
<b>AC TIMING WAVEFORMS</b> .....	1-111
<b>DERATING CURVES</b> .....	1-114
<b>RESET</b> .....	1-114
<b>BUS CYCLE WAVEFORMS</b> .....	1-117
<b>EXECUTION TIMINGS</b> .....	1-124
<b>INSTRUCTION SET SUMMARY</b> .....	1-125
<b>REVISION HISTORY</b> .....	1-131
<b>ERRATA</b> .....	1-131

1

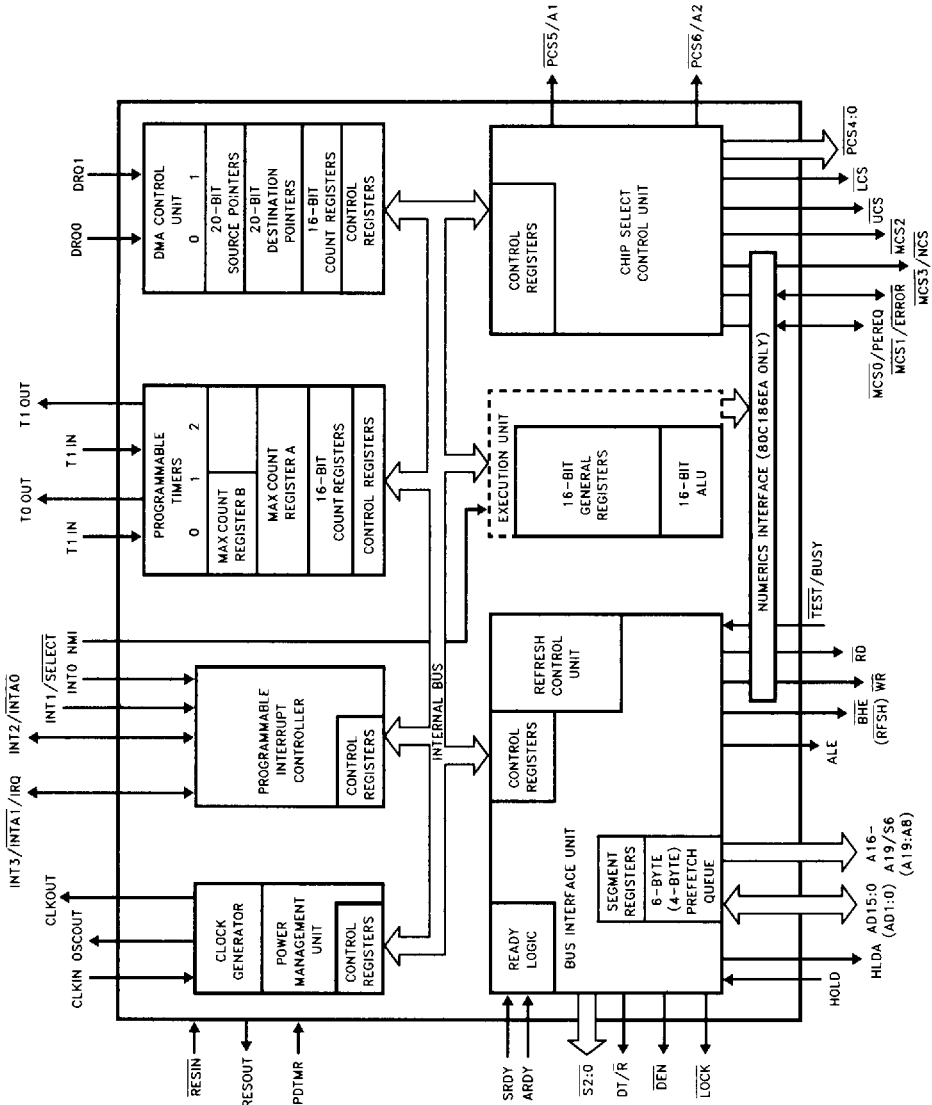

**NOTE:**  
Pin names in parentheses apply to the 80C186EA/80L188EA

Figure 1. 80C186EA/80C188EA Block Diagram



## INTRODUCTION

Unless specifically noted, all references to the 80C186EA apply to the 80C188EA, 80L186EA, and 80L188EA. References to pins that differ between the 80C186EA/80L186EA and the 80C188EA/80L188EA are given in parentheses. The "L" in the part number denotes low voltage operation. Physically and functionally, the "C" and "L" devices are identical.

The 80C186EA is the second product in a new generation of low-power, high-integration microprocessors. It enhances the existing 80C186XL family by offering new features and operating modes. The 80C186EA is object code compatible with the 80C186XL embedded processor.

The 80L186EA is the 3V version of the 80C186EA. The 80L186EA is functionally identical to the 80C186EA embedded processor. Current 80C186EA customers can easily upgrade their designs to use the 80L186EA and benefit from the reduced power consumption inherent in 3V operation.

The feature set of the 80C186EA/80L186EA meets the needs of low-power, space-critical applications. Low-power applications benefit from the static design of the CPU core and the integrated peripherals as well as low voltage operation. Minimum current consumption is achieved by providing a Powerdown Mode that halts operation of the device, and freezes the clock circuits. Peripheral design enhancements ensure that non-initialized peripherals consume little current.

Space-critical applications benefit from the integration of commonly used system peripherals. Two flexible DMA channels perform CPU-independent data transfers. A flexible chip select unit simplifies memory and peripheral interfacing. The interrupt unit provides sources for up to 128 external interrupts and will prioritize these interrupts with those generated from the on-chip peripherals. Three general purpose timer/counters round out the feature set of the 80C186EA.

Figure 1 shows a block diagram of the 80C186EA/80C188EA. The Execution Unit (EU) is an enhanced 8086 CPU core that includes: dedicated hardware to speed up effective address calculations, enhance execution speed for multiple-bit shift and rotate instructions and for multiply and divide instructions, string move instructions that operate at full bus bandwidth, ten new instructions, and static operation. The Bus Interface Unit (BIU) is the same as that found on the original 80C186 family products. An independent internal bus is used to allow communication between the BIU and internal peripherals.

## 80C186EA CORE ARCHITECTURE

### Bus Interface Unit

The 80C186EA core incorporates a bus controller that generates local bus control signals. In addition, it employs a HOLD/HLDA protocol to share the local bus with other bus masters.

The bus controller is responsible for generating 20 bits of address, read and write strobes, bus cycle status information and data (for write operations) information. It is also responsible for reading data off the local bus during a read operation. SRDY and ARDY input pins are provided to extend a bus cycle beyond the minimum four states (clocks).

The local bus controller also generates two control signals ( $\overline{DEN}$  and  $DT/\overline{R}$ ) when interfacing to external transceiver chips. This capability allows the addition of transceivers for simple buffering of the multiplexed address/data bus.

### Clock Generator

The processor provides an on-chip clock generator for both internal and external clock generation. The clock generator features a crystal oscillator, a divide-by-two counter, and two low-power operating modes.

The oscillator circuit is designed to be used with either a **parallel resonant** fundamental or third-overtone mode crystal network. Alternatively, the oscillator circuit may be driven from an external clock source. Figure 2 shows the various operating modes of the oscillator circuit.

The crystal or clock frequency chosen must be twice the required processor operating frequency due to the internal divide-by-two counter. This counter is used to drive all internal phase clocks and the external CLKOUT signal. CLKOUT is a 50% duty cycle processor clock and can be used to drive other system components. All AC timings are referenced to CLKOUT.

The following parameters are recommended when choosing a crystal:

Temperature Range:	Application Specific
ESR (Equivalent Series Resistance):	60Ω max
C0 (Shunt Capacitance of Crystal):	7.0 pF max
C <sub>L</sub> (Load Capacitance):	20 pF ± 2 pF
Drive Level:	2 mW max



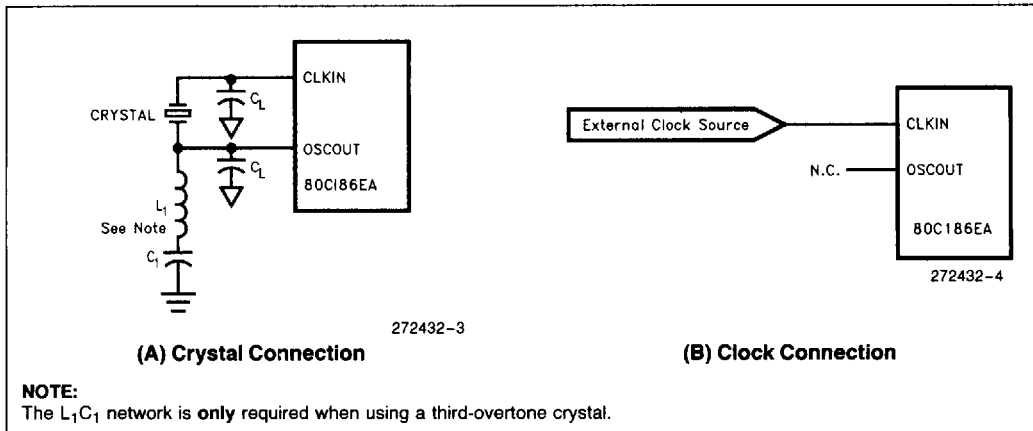

Figure 2. Clock Configurations

## 80C186EA PERIPHERAL ARCHITECTURE

The 80C186EA has integrated several common system peripherals with a CPU core to create a compact, yet powerful system. The integrated peripherals are designed to be flexible and provide logical interconnections between supporting units (e.g., the interrupt control unit supports interrupt requests from the timer/counters or DMA channels).

The list of integrated peripherals include:

- 4-Input Interrupt Control Unit
- 3-Channel Timer/Counter Unit
- 2-Channel DMA Unit
- 13-Output Chip-Select Unit
- Refresh Control Unit
- Power Management logic

The registers associated with each integrated peripheral are contained within a 128 x 16 register file called the Peripheral Control Block (PCB). The PCB can be located in either memory or I/O space on any 256 byte address boundary.

Figure 3 provides a list of the registers associated with the PCB when the processor's Interrupt Control Unit is in Master Mode. In Slave Mode, the definitions of some registers change. Figure 4 provides register definitions specific to Slave Mode.

## Interrupt Control Unit

The 80C186EA can receive interrupts from a number of sources, both internal and external. The Interrupt Control Unit (ICU) serves to merge these requests on a priority basis, for individual service by the CPU. Each interrupt source can be independently masked by the Interrupt Control Unit or all interrupts can be globally masked by the CPU.

Internal interrupt sources include the Timers and DMA channels. External interrupt sources come from the four input pins INT3:0. The NMI interrupt pin is not controlled by the ICU and is passed directly to the CPU. Although the timers only have one request input to the ICU, separate vector types are generated to service individual interrupts within the Timer Unit.

## Timer/Counter Unit

The 80C186EA Timer/Counter Unit (TCU) provides three 16-bit programmable timers. Two of these are highly flexible and are connected to external pins for control or clocking. A third timer is not connected to any external pins and can only be clocked internally. However, it can be used to clock the other two timer channels. The TCU can be used to count external events, time external events, generate non-repetitive waveforms, generate timed interrupts, etc.

PCB Offset	Function	PCB Offset	Function	PCB Offset	Function	PCB Offset	Function
00H	Reserved	40H	Reserved	80H	Reserved	C0H	DMA0 Src. Lo
02H	Reserved	42H	Reserved	82H	Reserved	C2H	DMA0 Src. Hi
04H	Reserved	44H	Reserved	84H	Reserved	C4H	DMA0 Dest. Lo
06H	Reserved	46H	Reserved	86H	Reserved	C6H	DMA0 Dest. Hi
08H	Reserved	48H	Reserved	88H	Reserved	C8H	DMA0 Count
0AH	Reserved	4AH	Reserved	8AH	Reserved	CAH	DMA0 Control
0CH	Reserved	4CH	Reserved	8CH	Reserved	CCH	Reserved
0EH	Reserved	4EH	Reserved	8EH	Reserved	CEH	Reserved
10H	Reserved	50H	Timer 0 Count	90H	Reserved	D0H	DMA1 Src. Lo
12H	Reserved	52H	Timer 0 Compare A	92H	Reserved	D2H	DMA1 Src. Hi
14H	Reserved	54H	Timer 0 Compare B	94H	Reserved	D4H	DMA1 Dest. Lo
16H	Reserved	56H	Timer 0 Control	96H	Reserved	D6H	DMA1 Dest. Hi
18H	Reserved	58H	Timer 1 Count	98H	Reserved	D8H	DMA1 Count
1AH	Reserved	5AH	Timer 1 Compare A	9AH	Reserved	DAH	DMA1 Control
1CH	Reserved	5CH	Timer 1 Compare B	9CH	Reserved	DCH	Reserved
1EH	Reserved	5EH	Timer 1 Control	9EH	Reserved	DEH	Reserved
20H	Reserved	60H	Timer 2 Count	A0H	UMCS	E0H	Refresh Base
22H	End of Interrupt	62H	Timer 2 Compare	A2H	LMCS	E2H	Refresh Time
24H	Poll	64H	Reserved	A4H	PACS	E4H	Refresh Control
26H	Poll Status	66H	Timer 2 Control	A6H	MMCS	E6H	Reserved
28H	Interrupt Mask	68H	Reserved	A8H	MPCS	E8H	Reserved
2AH	Priority Mask	6AH	Reserved	AAH	Reserved	EAH	Reserved
2CH	In-Service	6CH	Reserved	ACH	Reserved	ECH	Reserved
2EH	Interrupt Request	6EH	Reserved	AEH	Reserved	EEH	Reserved
30H	Interrupt Status	70H	Reserved	B0H	Reserved	F0H	Power-Save
32H	Timer Control	72H	Reserved	B2H	Reserved	F2H	Power Control
34H	DMA0 Int. Control	74H	Reserved	B4H	Reserved	F4H	Reserved
36H	DMA1 Int. Control	76H	Reserved	B6H	Reserved	F6H	Step ID
38H	INT0 Control	78H	Reserved	B8H	Reserved	F8H	Reserved
3AH	INT1 Control	7AH	Reserved	BAH	Reserved	FAH	Reserved
3CH	INT2 Control	7CH	Reserved	BCH	Reserved	FCH	Reserved
3EH	INT3 Control	7EH	Reserved	BEH	Reserved	FEH	Relocation

**Figure 3. Peripheral Control Block Registers**
**1**

PCB Offset	Function
20H	Interrupt Vector
22H	Specific EOI
24H	Reserved
26H	Reserved
28H	Interrupt Mask
2AH	Priority Mask
2C	In-Service
2E	Interrupt Request
30	Interrupt Status
32	TMR0 Interrupt Control
34	DMA0 Interrupt Control
36	DMA1 Interrupt Control
38	TMR1 Interrupt Control
3A	TMR2 Interrupt Control
3C	Reserved
3E	Reserved

**Figure 4. 80C186EA Slave Mode Peripheral Control Block Registers**

## DMA Control Unit

The 80C186EA DMA Control Unit provides two independent high-speed DMA channels. Data transfers can occur between memory and I/O space in any combination: memory to memory, memory to I/O, I/O to I/O or I/O to memory. Data can be transferred either in bytes or words. Transfers may proceed to or from either even or odd addresses, but even-aligned word transfers proceed at a faster rate. Each data transfer consumes two bus cycles (a minimum of eight clocks), one cycle to fetch data and the other to store data. The chip-select/ready logic may be programmed to point to the memory or I/O space subject to DMA transfers in order to provide hardware chip select lines. DMA cycles run at higher priority than general processor execution cycles.

## Chip-Select Unit

The 80C186EA Chip-Select Unit integrates logic which provides up to 13 programmable chip-selects to access both memories and peripherals. In addition, each chip-select can be programmed to automatically terminate a bus cycle independent of the condition of the SRDY and ARDY input pins. The chip-select lines are available for all memory and I/O bus cycles, whether they are generated by the CPU, the DMA unit, or the Refresh Control Unit.

## Refresh Control Unit

The Refresh Control Unit (RCU) automatically generates a periodic memory read bus cycle to keep dynamic or pseudo-static memory refreshed. A 9-bit counter controls the number of clocks between refresh requests.

A 9-bit address generator is maintained by the RCU with the address presented on the A9:1 address lines during the refresh bus cycle. Address bits A19:13 are programmable to allow the refresh address block to be located on any 8 Kbyte boundary.

## Power Management

The 80C186EA has three operational modes to control the power consumption of the device. They are Power Save Mode, Idle Mode, and Powerdown Mode.

Power Save Mode divides the processor clock by a programmable value to take advantage of the fact that current is linearly proportional to frequency. An unmasked interrupt, NMI, or reset will cause the 80C186EA to exit Power Save Mode.

Idle Mode freezes the clocks of the Execution Unit and the Bus Interface Unit at a logic zero state while all peripherals operate normally.

Powerdown Mode freezes all internal clocks at a logic zero level and disables the crystal oscillator. All internal registers hold their values provided  $V_{CC}$  is maintained. Current consumption is reduced to transistor leakage only.



## 80C187 Interface (80C186EA Only)

The 80C187 Numerics Coprocessor may be used to extend the 80C186EA instruction set to include floating point and advanced integer instructions. Connecting the 80C186EA RESOUT and TEST/BUSY pins to the 80C187 enables Numerics Mode operation. In Numerics Mode, three of the four Mid-Range Chip Select (MCS) pins become handshaking pins for the interface. The exchange of data and control information proceeds through four dedicated I/O ports.

If an 80C187 is not present, the 80C186EA configures itself for regular operation at reset.

### NOTE:

The 80C187 is not specified for 3V operation and therefore does not interface directly to the 80L186EA.

## ONCE Test Mode

To facilitate testing and inspection of devices when fixed into a target system, the 80C186EA has a test mode available which forces all output and input/output pins to be placed in the high-impedance state. ONCE stands for "ON Circuit Emulation". The ONCE mode is selected by forcing the UCS and LCS pins LOW (0) during a processor reset (these pins are weakly held to a HIGH (1) level) while RESIN is active.

## DIFFERENCES BETWEEN THE 80C186XL AND THE 80C186EA

The 80C186EA is intended as a direct functional upgrade for 80C186XL designs. In many cases, it will be possible to replace an existing 80C186XL with little or no hardware redesign. The following sections describe differences in pinout, operating modes, and AC and DC specifications to keep in mind.

## Pinout Compatibility

The 80C186EA requires a PDTMR pin to time the processor's exit from Powerdown Mode. The original pin arrangement for the 80C186XL in the PLCC package did not have any spare leads to use for PDTMR, so the DT/R pin was sacrificed. The arrangement of all the other leads in the 68-lead PLCC is identical between the 80C186XL and the 80C186EA. DT/R may be synthesized by latching the S1 status output. Therefore, upgrading a PLCC 80C186XL to PLCC 80C186EA is straightforward.

The 80-lead QFP (EIAJ) pinouts are different between the 80C186XL and the 80C186EA. In addition to the PDTMR pin, the 80C186EA has more power and ground pins and the overall arrangement of pins was shifted. A new circuit board layout for the 80C186EA is required.

## Operating Modes

The 80C186XL has two operating modes, Compatible and Enhanced. Compatible Mode is a pin-to-pin replacement for the NMOS 80186, except for numerics coprocessing. In Enhanced Mode, the processor has a Refresh Control Unit, the Power-Save feature and an interface to the 80C187 Numerics Coprocessor. The MCS0, MCS1, and MCS3 pins change their functions to constitute handshaking pins for the 80C187.

The 80C186EA allows all non-80C187 users to use all the MCS pins for chip-selects. In regular operation, all 80C186EA features (including those of the Enhanced Mode 80C186) are present except for the interface to the 80C187. Numerics Mode disables the three chip-select pins and reconfigures them for connection to the 80C187.

## TTL vs CMOS Inputs

The inputs of the 80C186EA are rated for CMOS switching levels for improved noise immunity, but the 80C186XL inputs are rated for TTL switching levels. In particular, the 80C186EA requires a minimum  $V_{IH}$  of 3.5V to recognize a logic one while the 80C186XL requires a minimum  $V_{IH}$  of only 1.9V (assuming 5.0V operation). The solution is to drive the 80C186EA with true CMOS devices, such as those from the HC and AC logic families, or to use pullup resistors where the added current draw is not a problem.

## Timing Specifications

80C186EA timing relationships are expressed in a simplified format over the 80C186XL. The AC performance of an 80C186EA at a specified frequency will be very close to that of an 80C186XL at the same frequency. Check the timings applicable to your design prior to replacing the 80C186XL.



## PACKAGE INFORMATION

This section describes the pins, pinouts, and thermal characteristics for the 80C186EA in the Plastic Leaded Chip Carrier (PLCC) package, Shrink Quad Flat Pack (SQFP), and Quad Flat Pack (QFP) package. For complete package specifications and information, see the Intel Packaging Outlines and Dimensions Guide (Order Number: 231369).

With the extended temperature range operational characteristics are guaranteed over a temperature range corresponding to  $-40^{\circ}\text{C}$  to  $+85^{\circ}\text{C}$  ambient. Package types are identified by a two-letter prefix to the part number. The prefixes are listed in Table 1.

Table 1. Prefix Identification

Prefix	Note	Package Type	Temperature Range
TN		PLCC	Extended
TS		QFP (EIAJ)	Extended
SB	1	SQFP	Extended/Commercial
N	1	PLCC	Commercial
S	1	QFP (EIAJ)	Commercial

### NOTE:

1. The 25 MHz version is only available in commercial temperature range corresponding to  $0^{\circ}\text{C}$  to  $+70^{\circ}\text{C}$  ambient.

## Pin Descriptions

Each pin or logical set of pins is described in Table 3. There are three columns for each entry in the Pin Description Table.

The **Pin Name** column contains a mnemonic that describes the pin function. Negation of the signal name (for example, RESIN) denotes a signal that is active low.

The **Pin Type** column contains two kinds of information. The first symbol indicates whether a pin is power (P), ground (G), input only (I), output only (O) or

input/output (I/O). Some pins have multiplexed functions (for example, A19/S6). Additional symbols indicate additional characteristics for each pin. Table 3 lists all the possible symbols for this column.

The **Input Type** column indicates the type of input (asynchronous or synchronous).

Asynchronous pins require that setup and hold times be met only in order to guarantee *recognition* at a particular clock edge. Synchronous pins require that setup and hold times be met to guarantee proper *operation*. For example, missing the setup or hold time for the SRDY pin (a synchronous input) will result in a system failure or lockup. Input pins may also be edge- or level-sensitive. The possible characteristics for input pins are S(E), S(L), A(E) and A(L).

The **Output States** column indicates the output state as a function of the device operating mode. Output states are dependent upon the current activity of the processor. There are four operational states that are different from regular operation: bus hold, reset, Idle Mode and Powerdown Mode. Appropriate characteristics for these states are also indicated in this column, with the legend for all possible characteristics in Table 2.

The **Pin Description** column contains a text description of each pin.

As an example, consider AD15:0. I/O signifies the pins are bidirectional. S(L) signifies that the input function is synchronous and level-sensitive. H(Z) signifies that, as outputs, the pins are high-impedance upon acknowledgement of bus hold. R(Z) signifies that the pins float during reset. P(X) signifies that the pins retain their states during Powerdown Mode.

**Table 2. Pin Description Nomenclature**

Symbol	Description
P	Power Pin (Apply + V <sub>CC</sub> Voltage)
G	Ground (Connect to V <sub>SS</sub> )
I	Input Only Pin
O	Output Only Pin
I/O	Input/Output Pin
S(E)	Synchronous, Edge Sensitive
S(L)	Synchronous, Level Sensitive
A(E)	Asynchronous, Edge Sensitive
A(L)	Asynchronous, Level Sensitive
H(1)	Output Driven to V <sub>CC</sub> during Bus Hold
H(0)	Output Driven to V <sub>SS</sub> during Bus Hold
H(Z)	Output Floats during Bus Hold
H(Q)	Output Remains Active during Bus Hold
H(X)	Output Retains Current State during Bus Hold
R(WH)	Output Weakly Held at V <sub>CC</sub> during Reset
R(1)	Output Driven to V <sub>CC</sub> during Reset
R(0)	Output Driven to V <sub>SS</sub> during Reset
R(Z)	Output Floats during Reset
R(Q)	Output Remains Active during Reset
R(X)	Output Retains Current State during Reset
I(1)	Output Driven to V <sub>CC</sub> during Idle Mode
I(0)	Output Driven to V <sub>SS</sub> during Idle Mode
I(Z)	Output Floats during Idle Mode
I(Q)	Output Remains Active during Idle Mode
I(X)	Output Retains Current State during Idle Mode
P(1)	Output Driven to V <sub>CC</sub> during Powerdown Mode
P(0)	Output Driven to V <sub>SS</sub> during Powerdown Mode
P(Z)	Output Floats during Powerdown Mode
P(Q)	Output Remains Active during Powerdown Mode
P(X)	Output Retains Current State during Powerdown Mode

1

Table 3. Pin Descriptions

Pin Name	Pin Type	Input Type	Output States	Description
V <sub>CC</sub>	P			<b>POWER</b> connections consist of six pins which must be shorted externally to a V <sub>CC</sub> board plane.
V <sub>SS</sub>	G			<b>GROUND</b> connections consist of five pins which must be shorted externally to a V <sub>SS</sub> board plane.
CLKIN	I	A(E)		<b>CLock Input</b> is an input for an external clock. An external oscillator operating at two times the required processor operating frequency can be connected to CLKIN. For crystal operation, CLKIN (along with OSCOUT) are the crystal connections to an internal Pierce oscillator.
OSCOUT	O		H(Q) R(Q) P(Q)	<b>OSCillator OUTPUT</b> is only used when using a crystal to generate the external clock. OSCOUT (along with CLKIN) are the crystal connections to an internal Pierce oscillator. This pin is not to be used as 2X clock output for non-crystal applications (i.e., this pin is N.C. for non-crystal applications). OSCOUT does not float in ONCE mode.
CLKOUT	O		H(Q) R(Q) P(Q)	<b>CLock OUTPUT</b> provides a timing reference for inputs and outputs of the processor, and is one-half the input clock (CLKIN) frequency. CLKOUT has a 50% duty cycle and transitions every falling edge of CLKIN.
RESIN	I	A(L)		<b>RESet IN</b> causes the processor to immediately terminate any bus cycle in progress and assume an initialized state. All pins will be driven to a known state, and RESOUT will also be driven active. The rising edge (low-to-high) transition synchronizes CLKOUT with CLKIN before the processor begins fetching opcodes at memory location 0FFFF0H.
RESOUT	O		H(0) R(1) P(0)	<b>RESet OUTPUT</b> that indicates the processor is currently in the reset state. RESOUT will remain active as long as RESIN remains active. When tied to the TEST/BUSY pin, RESOUT forces the 80C186EA into Numerics Mode.
PDTMR	I/O	A(L)	H(WH) R(Z) P(1)	<b>Power-Down TIMEr</b> pin (normally connected to an external capacitor) that determines the amount of time the processor waits after an exit from power down before resuming normal operation. The duration of time required will depend on the startup characteristics of the crystal oscillator.
NMI	I	A(E)		<b>Non-Maskable Interrupt</b> input causes a Type 2 interrupt to be serviced by the CPU. NMI is latched internally.
TEST/BUSY (TEST)	I	A(E)		<b>TEST/BUSY</b> is sampled upon reset to determine whether the 80C186EA is to enter Numerics Mode. In regular operation, the pin is <b>TEST</b> . TEST is used during the execution of the WAIT instruction to suspend CPU operation until the pin is sampled active (low). In Numerics Mode, the pin is <b>BUSY</b> . BUSY notifies the 80C186EA of 80C187 Numerics Coprocessor activity.
AD15:0 (AD7:0)	I/O	S(L)	H(Z) R(Z) P(X)	These pins provide a multiplexed <b>Address</b> and <b>Data</b> bus. During the address phase of the bus cycle, address bits 0 through 15 (0 through 7 on the 8-bit bus versions) are presented on the bus and can be latched using ALE. 8- or 16-bit data information is transferred during the data phase of the bus cycle.

**NOTE:**

Pin names in parentheses apply to the 80C188EA and 80L188EA.

Table 3. Pin Descriptions (Continued)

Pin Name	Pin Type	Input Type	Output States	Description																																
A18:16 A19/S6–A16 (A19–A8)	O		H(Z) R(Z) P(X)	These pins provide multiplexed <b>Address</b> during the address phase of the bus cycle. Address bits 16 through 19 are presented on these pins and can be latched using ALE. A18:16 are driven to a logic 0 during the data phase of the bus cycle. On the 8-bit bus versions, A15–A8 provide valid address information for the entire bus cycle. Also during the data phase, S6 is driven to a logic 0 to indicate a CPU-initiated bus cycle or logic 1 to indicate a DMA-initiated bus cycle or a refresh cycle.																																
S2:0	O		H(Z) R(Z) P(1)	Bus cycle <b>Status</b> are encoded on these pins to provide bus transaction information. S2:0 are encoded as follows:																																
				<table border="1"> <thead> <tr> <th>S2</th> <th>S1</th> <th>S0</th> <th>Bus Cycle Initiated</th> </tr> </thead> <tbody> <tr> <td>0</td> <td>0</td> <td>0</td> <td>Interrupt Acknowledge</td> </tr> <tr> <td>0</td> <td>0</td> <td>1</td> <td>Read I/O</td> </tr> <tr> <td>0</td> <td>1</td> <td>0</td> <td>Write I/O</td> </tr> <tr> <td>0</td> <td>1</td> <td>1</td> <td>Processor HALT</td> </tr> <tr> <td>1</td> <td>0</td> <td>0</td> <td>Queue Instruction Fetch</td> </tr> <tr> <td>1</td> <td>0</td> <td>1</td> <td>Read Memory</td> </tr> <tr> <td>1</td> <td>1</td> <td>0</td> <td>Write Memory</td> </tr> <tr> <td>1</td> <td>1</td> <td>1</td> <td>Passive (no bus activity)</td> </tr> </tbody> </table>	S2	S1	S0	Bus Cycle Initiated	0	0	0	Interrupt Acknowledge	0	0	1	Read I/O	0	1	0	Write I/O	0	1	1	Processor HALT	1	0	0	Queue Instruction Fetch	1	0	1	Read Memory	1	1	0	Write Memory
S2	S1	S0	Bus Cycle Initiated																																	
0	0	0	Interrupt Acknowledge																																	
0	0	1	Read I/O																																	
0	1	0	Write I/O																																	
0	1	1	Processor HALT																																	
1	0	0	Queue Instruction Fetch																																	
1	0	1	Read Memory																																	
1	1	0	Write Memory																																	
1	1	1	Passive (no bus activity)																																	
ALE/QS0	O		H(0) R(0) P(0)	<b>Address Latch Enable</b> output is used to strobe address information into a transparent type latch during the address phase of the bus cycle. In Queue Status Mode, QS0 provides queue status information along with QS1.																																
BHE (RFSH)	O		H(Z) R(Z) P(X)	<b>Byte High Enable</b> output to indicate that the bus cycle in progress is transferring data over the upper half of the data bus. BHE and A0 have the following logical encoding:																																
				<table border="1"> <thead> <tr> <th>A0</th> <th>BHE</th> <th>Encoding (For 80C186EA/80L186EA Only)</th> </tr> </thead> <tbody> <tr> <td>0</td> <td>0</td> <td>Word Transfer</td> </tr> <tr> <td>0</td> <td>1</td> <td>Even Byte Transfer</td> </tr> <tr> <td>1</td> <td>0</td> <td>Odd Byte Transfer</td> </tr> <tr> <td>1</td> <td>1</td> <td>Refresh Operation</td> </tr> </tbody> </table>	A0	BHE	Encoding (For 80C186EA/80L186EA Only)	0	0	Word Transfer	0	1	Even Byte Transfer	1	0	Odd Byte Transfer	1	1	Refresh Operation																	
A0	BHE	Encoding (For 80C186EA/80L186EA Only)																																		
0	0	Word Transfer																																		
0	1	Even Byte Transfer																																		
1	0	Odd Byte Transfer																																		
1	1	Refresh Operation																																		
				On the 80C188EA/80L188EA, RFSH is asserted low to indicate a Refresh bus cycle.																																
RD/QSMD	O		H(Z) R(WH) P(1)	<b>Read</b> output signals that the accessed memory or I/O device must drive data information onto the data bus. Upon reset, this pin has an alternate function. As QSMD, it enables <b>Queue Status Mode</b> when grounded. In Queue Status Mode, the ALE/QS0 and WR/QS1 pins provide the following information about processor/instruction queue interaction:																																
				<table border="1"> <thead> <tr> <th>QS1</th> <th>QS0</th> <th>Queue Operation</th> </tr> </thead> <tbody> <tr> <td>0</td> <td>0</td> <td>No Queue Operation</td> </tr> <tr> <td>0</td> <td>1</td> <td>First Opcode Byte Fetched from the Queue</td> </tr> <tr> <td>1</td> <td>1</td> <td>Subsequent Byte Fetched from the Queue</td> </tr> <tr> <td>1</td> <td>0</td> <td>Empty the Queue</td> </tr> </tbody> </table>	QS1	QS0	Queue Operation	0	0	No Queue Operation	0	1	First Opcode Byte Fetched from the Queue	1	1	Subsequent Byte Fetched from the Queue	1	0	Empty the Queue																	
QS1	QS0	Queue Operation																																		
0	0	No Queue Operation																																		
0	1	First Opcode Byte Fetched from the Queue																																		
1	1	Subsequent Byte Fetched from the Queue																																		
1	0	Empty the Queue																																		

**NOTE:**

Pin names in parentheses apply to the 80C188EA and 80L188EA.

Table 3. Pin Descriptions (Continued)

Pin Name	Pin Type	Input Type	Output States	Description
WR/QS1	O		H(Z) R(Z) P(1)	<b>Write</b> output signals that data available on the data bus are to be written into the accessed memory or I/O device. In Queue Status Mode, QS1 provides queue status information along with QS0.
ARDY	I	A(L) S(L)		<b>Asynchronous Ready</b> is an input to signal for the end of a bus cycle. ARDY is asynchronous on rising CLKOUT and synchronous on falling CLKOUT. ARDY or SRDY must be active to terminate any processor bus cycle, unless they are ignored due to correct programming of the Chip Select Unit.
SRDY	I	S(L)		<b>Synchronous Ready</b> is an input to signal for the end of a bus cycle. ARDY or SRDY must be active to terminate any processor bus cycle, unless they are ignored due to correct programming of the Chip Select Unit.
$\overline{\text{DEN}}$	O	H(Z) R(Z) P(1)		<b>Data Enable</b> output to control the enable of bidirectional transceivers when buffering a system. $\overline{\text{DEN}}$ is active only when data is to be transferred on the bus.
DT/ $\overline{\text{R}}$	O		H(Z) R(Z) P(X)	<b>Data Transmit/Receive</b> output controls the direction of a bi-directional buffer in a buffered system. DT/ $\overline{\text{R}}$ is only available on the QFP (EIAJ) package and the SQFP package.
LOCK	O		H(Z) R(WH) P(1)	<b>LOCK</b> output indicates that the bus cycle in progress is not to be interrupted. The processor will not service other bus requests (such as HOLD) while LOCK is active. This pin is configured as a weakly held high input while $\overline{\text{RESIN}}$ is active and must not be driven low.
HOLD	I	A(L)		<b>HOLD</b> request input to signal that an external bus master wishes to gain control of the local bus. The processor will relinquish control of the local bus between instruction boundaries not conditioned by a LOCK prefix.
HLDA	O		H(1) R(0) P(0)	<b>Hold Acknowledge</b> output to indicate that the processor has relinquished control of the local bus. When HLDA is asserted, the processor will (or has) floated its data bus and control signals allowing another bus master to drive the signals directly.
$\overline{\text{UCS}}$	O		H(1) R(1) P(1)	<b>Upper Chip Select</b> will go active whenever the address of a memory or I/O bus cycle is within the address limitations programmed by the user. After reset, $\overline{\text{UCS}}$ is configured to be active for memory accesses between 0FFC00H and 0FFFFFFH. During a processor reset, $\overline{\text{UCS}}$ and $\overline{\text{LCS}}$ are used to enable ONCE Mode.
$\overline{\text{LCS}}$	O		H(1) R(1) P(1)	<b>Lower Chip Select</b> will go active whenever the address of a memory bus cycle is within the address limitations programmed by the user. $\overline{\text{LCS}}$ is inactive after a reset. During a processor reset, $\overline{\text{UCS}}$ and $\overline{\text{LCS}}$ are used to enable ONCE Mode.

**NOTE:**

Pin names in parentheses apply to the 80C188EA and 80L188EA.

Table 3. Pin Descriptions (Continued)

Pin Name	Pin Type	Input Type	Output States	Description
MCS0/PEREQ MCS1/ERROR MCS2 MCS3/NCS	I/O	A(L)	H(1) R(1) P(1)	These pins provide a multiplexed function. If enabled, these pins normally comprise a block of <b>Mid-Range Chip Select</b> outputs which will go active whenever the address of a memory bus cycle is within the address limitations programmed by the user. In Numerics Mode (80C186EA only), three of the pins become handshaking pins for the 80C187. The <b>CoProcessor REQuest</b> input signals that a data transfer is pending. <b>ERROR</b> is an input which indicates that the previous numerics coprocessor operation resulted in an exception condition. An interrupt Type 16 is generated when <b>ERROR</b> is sampled active at the beginning of a numerics operation. <b>Numerics Coprocessor Select</b> is an output signal generated when the processor accesses the 80C187.
PCS4:0	O		H(1) R(1) P(1)	<b>Peripheral Chip Selects</b> go active whenever the address of a memory or I/O bus cycle is within the address limitations programmed by the user.
PCS5/A1 PCS6/A2	O		H(1)/H(X) R(1) P(1)	These pins provide a multiplexed function. As additional <b>Peripheral Chip Selects</b> , they go active whenever the address of a memory or I/O bus cycle is within the address limitations by the user. They may also be programmed to provide latched <b>Address A2:1</b> signals.
T0OUT T1OUT	O		H(Q) R(1) P(Q)	<b>Timer OUTput</b> pins can be programmed to provide a single clock or continuous waveform generation, depending on the timer mode selected.
T0IN T1IN	I	A(L) A(E)		<b>Timer INput</b> is used either as clock or control signals, depending on the timer mode selected.
DRQ0 DRQ1	I	A(L)		<b>DMA ReQuest</b> is asserted by an external request when it is prepared for a DMA transfer.
INT0 INT1/SELECT	I	A(E,L)		Maskable <b>INTerrupt</b> input will cause a vector to a specific Type interrupt routine. To allow interrupt expansion, INT0 and/or INT1 can be used with INTA0 and INTA1 to interface with an external slave controller. INT1 becomes <b>SELECT</b> when the ICU is configured for Slave Mode.
INT2/INTA0 INT3/INTA1/IRQ	I/O	A(E,L)	H(1) R(Z) P(1)	These pins provide multiplexed functions. As inputs, they provide a maskable <b>INTerrupt</b> that will cause the CPU to vector to a specific Type interrupt routine. As outputs, each is programmatically controlled to provide an <b>INTerrupt Acknowledge</b> handshake signal to allow interrupt expansion. INT3/INTA1 becomes <b>IRQ</b> when the ICU is configured for Slave Mode.
N.C.				<b>No Connect</b> . For compatibility with future products, do not connect to these pins.

**NOTE:**

Pin names in parentheses apply to the 80C188EA and 80L188EA.

1



**80C186EA PINOUT**

Tables 4 and 5 list the 80C186EA pin names with package location for the 68-pin Plastic Leaded Chip Carrier (PLCC) component. Figure 9 depicts the complete 80C186EA/80L186EA pinout (PLCC package) as viewed from the top side of the component (i.e., contacts facing down).

Tables 6 and 7 list the 80C186EA pin names with package location for the 80-pin Quad Flat Pack (EIAJ) component. Figure 6 depicts the complete

80C186EA/80C188EA (EIAJ QFP package) as viewed from the top side of the component (i.e., contacts facing down).

Tables 8 and 9 list the 80C186EA/80C188EA pin names with package location for the 80-pin Shrink Quad Flat Pack (SQFP) component. Figure 7 depicts the complete 80C186EA/80C188EA (SQFP) as viewed from the top side of the component (i.e., contacts facing down).

**Table 4. PLCC Pin Names with Package Location**

Address/Data Bus		Bus Control		Processor Control		I/O	
Name	Location	Name	Location	Name	Location	Name	Location
AD0	17	ALE/QS0	61	RESIN	24	UCS	34
AD1	15	BHE (RFSH)	64	RESOUT	57	LCS	33
AD2	13	S0	52	CLKIN	59	MCS0/PEREQ	38
AD3	11	S1	53	OSCOU	58	MCS1/ERROR	37
AD4	8	S2	54	CLKOUT	56	MCS2	36
AD5	6	RD/QSMD	62	TEST/BUSY	47	MCS3/NCS	35
AD6	4	WR/QS1	63	PDTMR	40	PCS0	25
AD7	2	ARDY	55	NMI	46	PCS1	27
AD8 (A8)	16	SRDY	49	INT0	45	PCS2	28
AD9 (A9)	14	DEN	39	INT1/SELECT	44	PCS3	29
AD10 (A10)	12	LOCK	48	INT2/INTA0	42	PCS4	30
AD11 (A11)	10	HOLD	50	INT3/INTA1/	41	PCS5/A1	31
AD12 (A12)	7	HLDA	51	IRQ		PCS6/A2	32
AD13 (A13)	5					TOOUT	22
AD14 (A14)	3					T0IN	20
AD15 (A15)	1					T1OUT	23
A16	68					T1IN	21
A17	67					DRQ0	18
A18	66					DRQ1	19
A19/S6	65						

Power	
Name	Location
V <sub>SS</sub>	26, 60
V <sub>CC</sub>	9, 43

**NOTE:**

Pin names in parentheses apply to the 80C188EA/80L188EA.

Table 5. PLCC Package Location with Pin Names

Location	Name	Location	Name	Location	Name	Location	Name
1	AD15 (A15)	18	DRQ0	35	MCS3/NCS	52	S0
2	AD7	19	DRQ1	36	MCS2	53	S1
3	AD14 (A14)	20	T0IN	37	MCS1/ERROR	54	S2
4	AD6	21	T1IN	38	MCS0/PEREQ	55	ARDY
5	AD13 (A13)	22	T0OUT	39	DEN	56	CLKOUT
6	AD5	23	T1OUT	40	PDTMR	57	RESOUT
7	AD12 (A12)	24	RESIN	41	INT3/INTA1/ IRQ	58	OSCOUT
8	AD4	25	PCS0	42	INT2/INTA0	59	CLKIN
9	VCC	26	VSS	43	VCC	60	VSS
10	AD11 (A11)	27	PCS1	44	INT1/SELECT	61	ALE/QS0
11	AD3	28	PCS2	45	INT0	62	RD/QSMD
12	AD10 (A10)	29	PCS3	46	NMI	63	WR/QS1
13	AD2	30	PCS4	47	TEST/BUSY	64	BHE (RFSH)
14	AD9 (A9)	31	PCS5/A1	48	LOCK	65	A19/S6
15	AD1	32	PCS6/A2	49	SRDY	66	A18
16	AD8 (A8)	33	LCS	50	HOLD	67	A17
17	AD0	34	UCS	51	HLDA	68	A16

1

**NOTE:**

Pin names in parentheses apply to the 80C186EA/80L188EA.

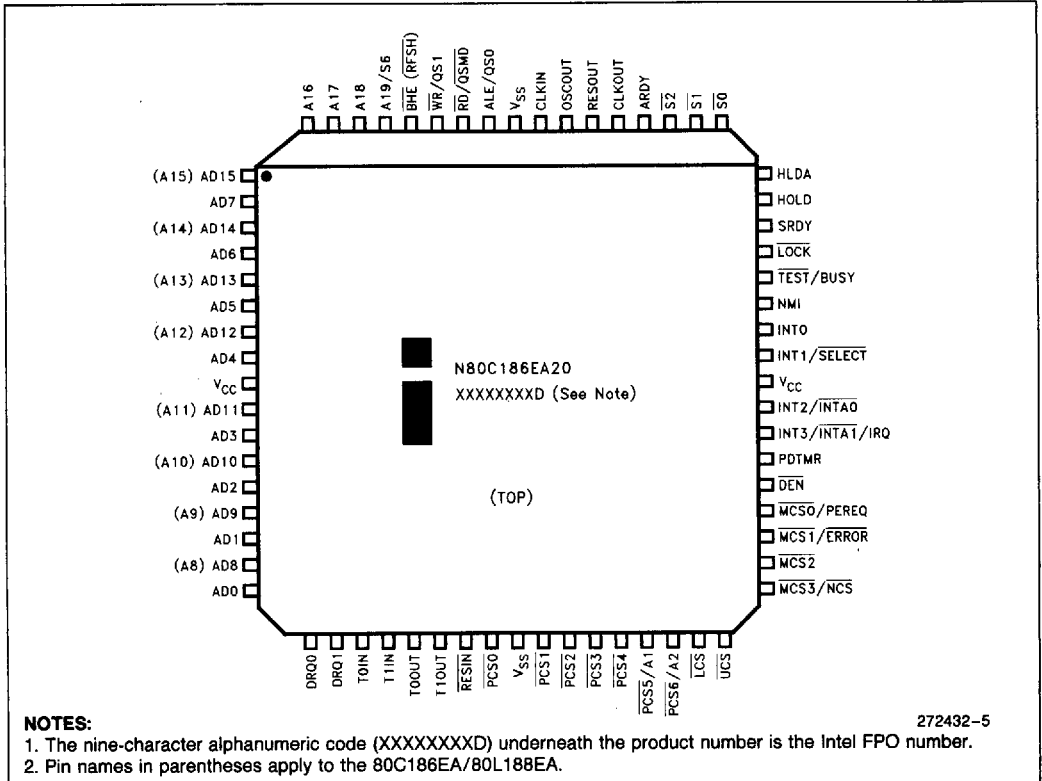

Figure 5. 68-Lead PLCC Pinout Diagram



Table 6. QFP (EIAJ) Pin Names with Package Location

Address/Data Bus		Bus Control		Processor Control		I/O	
Name	Location	Name	Location	Name	Location	Name	Location
AD0	64	ALE/QS0	10	RESIN	55	UCS	45
AD1	66	BHE (RFSH)	7	RESOUT	18	LCS	46
AD2	68	S0	23	CLKIN	16	MCS0/PEREQ	40
AD3	70	S1	22	OSCOU	17	MCST1/ERROR	41
AD4	74	S2	21	CLKOUT	19	MCS2	42
AD5	76	RD/QSMD	9	TEST/BUSY	29	MCS3/NCS	43
AD6	78	WR/QS1	8	PDTMR	38	PCS0	54
AD7	80	ARDY	20	NMI	30	PCS1	52
AD8 (A8)	65	SRDY	27	INT0	31	PCS2	51
AD9 (A9)	67	DT/R	37	INT1/SELECT	32	PCS3	50
AD10 (A10)	69	DN	39	INT2/INTA0	35	PCS4	49
AD11 (A11)	71	LOCK	28	INT3/INTA1/	36	PCS5/A1	48
AD12 (A12)	75	HOLD	26	IRQ		PCS6/A2	47
AD13 (A13)	77	HLDA	25	N.C.	11, 14, 15, 63	TOOUT	57
AD14 (A14)	79					TOIN	59
AD15 (A15)	1					T1OUT	56
A16	3					T1IN	58
A17	4					DRQ0	61
A18	5					DRQ1	60
A19/S6	6						
		<b>Power</b>					
		<b>Name</b>	<b>Location</b>				
		V <sub>SS</sub>	12, 13, 24, 53, 62				
		V <sub>CC</sub>	2, 33, 34, 44, 72, 73				

**NOTE:**

Pin names in parentheses apply to the 80C186EA/80L188EA.

Table 7. QFP (EIAJ) Package Location with Pin Names

Location	Name	Location	Name	Location	Name	Location	Name
1	AD15 (A15)	21	S2	41	MCST/ERROR	61	DRQ0
2	V <sub>CC</sub>	22	S1	42	MCS2	62	V <sub>SS</sub>
3	A16	23	S0	43	MCS3/NCS	63	N.C.
4	A17	24	V <sub>SS</sub>	44	V <sub>CC</sub>	64	AD0
5	A18	25	HLDA	45	UCS	65	AD8 (A8)
6	A19/S6	26	HOLD	46	LCS	66	AD1
7	BHE (RFSH)	27	SRDY	47	PCS6/A2	67	AD9 (A9)
8	WR/QS1	28	LOCK	48	PCS5/A1	68	AD2
9	RD/QSMD	29	TEST/BUSY	49	PCS4	69	AD10 (A10)
10	ALE/QS0	30	NMI	50	PCS3	70	AD3
11	N.C.	31	INT0	51	PCS2	71	AD11 (A11)
12	V <sub>SS</sub>	32	INT1/SELECT	52	PCS1	72	V <sub>CC</sub>
13	V <sub>SS</sub>	33	V <sub>CC</sub>	53	V <sub>SS</sub>	73	V <sub>CC</sub>
14	N.C.	34	V <sub>CC</sub>	54	PCS0	74	AD4
15	N.C.	35	INT2/INTA0	55	RESIN	75	AD12 (A12)
16	CLKIN	36	INT3/INTA1/	56	T1OUT	76	AD5
17	OSCOU	37	IRQ	57	T0OUT	77	AD13 (A13)
18	RESOU	38	DT/R	58	T1IN	78	AD6
19	CLKOU	39	PDTMR	59	T0IN	79	AD14 (A14)
20	ARDY	40	MCS0/PEREQ	60	DRQ1	80	AD7

**NOTE:**

Pin names in parentheses apply to the 80C186EA/80L188EA.

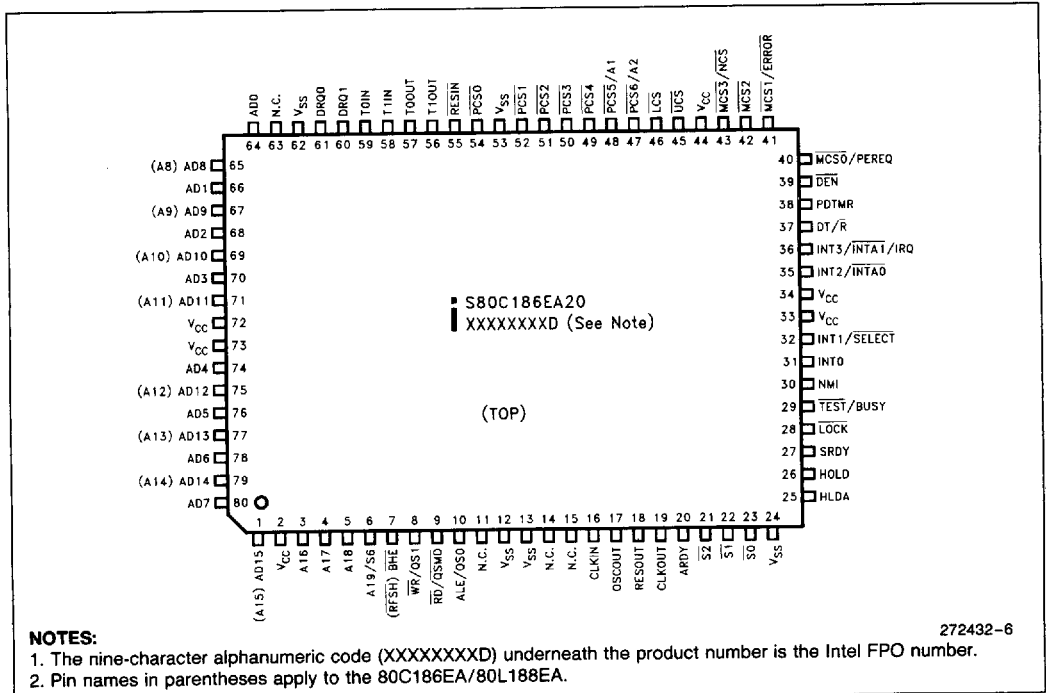

Figure 6. Quad Flat Pack (EIAJ) Pinout Diagram

**Table 8. SQFP Pin Functions with Package Location**

AD Bus		Bus Control		Processor Control		I/O	
AD0	1	ALE/QS0	29	RESIN	73	UCS	62
AD1	3	BHE/(RFSH)	26	RESOUT	34	LCS	63
AD2	6	S0	40	CLKIN	32	MCS0/PEREQ	57
AD3	8	S1	39	OSCOU	33	MCS1/ERROR	58
AD4	12	S2	38	CLKOUT	36	MCS2	59
AD5	14	RD/QSMD	28	TEST/BUSY	46	MCS3/NPS	60
AD6	16	WR/QS1	27	NMI	47	PCS0	71
AD7	18	ARDY	37	INT0	48	PCS1	69
AD8 (A8)	2	SRDY	44	INT1/SELECT	49	PCS2	68
AD9 (A9)	5	DEN	56	INT2/INTA0	52	PCS3	67
AD10 (A10)	7	DT/R	54	INT3/INTA1	53	PCS4	66
AD11 (A11)	9	LOCK	45	PDTMR	55	PCS5/A1	65
AD12 (A12)	13	HOLD	43			PCS6/A2	64
AD13 (A13)	15	HLDA	42			TMR IN 0	77
AD14 (A14)	17					TMR IN 1	76
AD15 (A15)	19					TMR OUT 0	75
A16/S3	21					TMR OUT 1	74
A17/S4	22					DRQ0	79
A18/S5	23					DRQ1	78
A19/S6	24						

No Connection	
N.C.	4
N.C.	25
N.C.	35
N.C.	72

Power and Ground	
V <sub>CC</sub>	10
V <sub>CC</sub>	11
V <sub>CC</sub>	20
V <sub>CC</sub>	50
V <sub>CC</sub>	51
V <sub>CC</sub>	61
V <sub>SS</sub>	30
V <sub>SS</sub>	31
V <sub>SS</sub>	41
V <sub>SS</sub>	70
V <sub>SS</sub>	80

**NOTE:**

Pin names in parentheses apply to the 80C186EA/80L188EA.

**Table 9. SQFP Pin Locations with Pin Names**

1	AD0	21	A16/S3	41	V <sub>SS</sub>	61	V <sub>CC</sub>
2	AD8 (A8)	22	A17/S4	42	HLDA	62	UCS
3	AD1	23	A18/S5	43	HOLD	63	LCS
4	N.C.	24	A19/S6	44	SRDY	64	PCS6/A2
5	AD9 (A9)	25	N.C.	45	LOCK	65	PCS5/A1
6	AD2	26	BHE/(RFSH)	46	TEST/BUSY	66	PCS4
7	AD10 (A10)	27	WR/QS1	47	NMI	67	PCS3
8	AD3	28	RD/QSMD	48	INT0	68	PCS2
9	AD11 (A11)	29	ALE/QS0	49	INT1/SELECT	69	PCS1
10	V <sub>CC</sub>	30	V <sub>SS</sub>	50	V <sub>CC</sub>	70	V <sub>SS</sub>
11	V <sub>CC</sub>	31	V <sub>SS</sub>	51	V <sub>CC</sub>	71	PCS0
12	AD4	32	X1	52	INT2/INTA0	72	N.C.
13	AD12 (A12)	33	X2	53	INT3/INTA1	73	RES
14	AD5	34	RESET	54	DT/R	74	TMR OUT 1
15	AD13 (A13)	35	N.C.	55	PDTMR	75	TMR OUT 0
16	AD6	36	CLKOUT	56	DEN	76	TMR IN 1
17	AD14 (A14)	37	ARDY	57	MCS0/PEREQ	77	TMR IN 0
18	AD7	38	S2	58	MCS1/ERROR	78	DRQ1
19	AD15 (A15)	39	S1	59	MCS2	79	DRQ0
20	V <sub>CC</sub>	40	S0	60	MCS3/NPS	80	V <sub>SS</sub>

**NOTE:**

Pin names in parentheses apply to the 80C186EA/80L188EA.

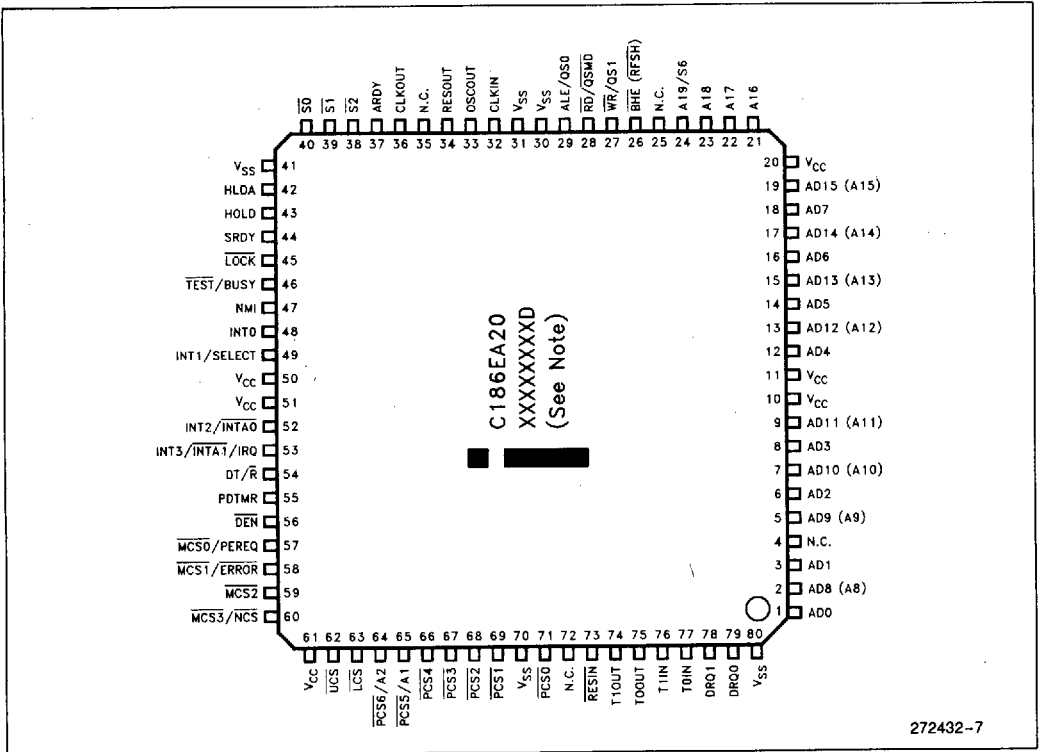

Figure 7. Shrink Quad Flat Pack (SQFP) Pinout Diagram

**NOTES:**

1. XXXXXXXXD indicates the Intel FPO number.
2. Pin names in parentheses apply to the 80C188EA.

**PACKAGE THERMAL SPECIFICATIONS**

The 80C186EA/80L186EA is specified for operation when  $T_C$  (the case temperature) is within the range of 0°C to 85°C (PLCC package) or 0°C to 106°C (QFP-EIAJ) package.  $T_C$  may be measured in any environment to determine whether the processor is within the specified operating range. The case temperature must be measured at the center of the top surface.

$T_A$  (the ambient temperature) can be calculated from  $\theta_{CA}$  (thermal resistance from the case to ambient) with the following equation:

$$T_A = T_C - P \times \theta_{CA}$$

Typical values for  $\theta_{CA}$  at various airflows are given in Table 10.

P (the maximum power consumption, specified in watts) is calculated by using the maximum ICC as tabulated in the DC specifications and  $V_{CC}$  of 5.5V.

Table 10. Thermal Resistance ( $\theta_{CA}$ ) at Various Airflows (in °C/Watt)

	Airflow Linear ft/min (m/sec)					
	0 (0)	200 (1.01)	400 (2.03)	600 (3.04)	800 (4.06)	1000 (5.07)
$\theta_{CA}$ (PLCC)	29	25	21	19	17	16.5
$\theta_{CA}$ (QFP)	66	63	60.5	59	58	57
$\theta_{CA}$ (SQFP)	70					

**ELECTRICAL SPECIFICATIONS****Absolute Maximum Ratings\***

Storage Temperature .....	-65°C to +150°C
Case Temperature under Bias ...	-65°C to +150°C
Supply Voltage with Respect to $V_{SS}$ .....	-0.5V to +6.5V
Voltage on Other Pins with Respect to $V_{SS}$ .....	-0.5V to $V_{CC} + 0.5V$

**Recommended Connections**

Power and ground connections must be made to multiple  $V_{CC}$  and  $V_{SS}$  pins. Every 80C186EA based circuit board should contain separate power ( $V_{CC}$ ) and ground ( $V_{SS}$ ) planes. All  $V_{CC}$  and  $V_{SS}$  pins **must** be connected to the appropriate plane. Pins identified as "N.C." must not be connected in the system. Decoupling capacitors should be placed near the processor. The value and type of decoupling capac-

NOTICE: This data sheet contains preliminary information on new products in production. It is valid for the devices indicated in the revision history. The specifications are subject to change without notice.

*\*WARNING: Stressing the device beyond the "Absolute Maximum Ratings" may cause permanent damage. These are stress ratings only. Operation beyond the "Operating Conditions" is not recommended and extended exposure beyond the "Operating Conditions" may affect device reliability.*

itors is application and board layout dependent. The processor can cause transient power surges when its output buffers transition, particularly when connected to large capacitive loads.

Always connect any unused input pins to an appropriate signal level. In particular, unused interrupt pins (NMI, INT3:0) should be connected to  $V_{SS}$  to avoid unwanted interrupts. **Leave any unused output pin or any "N.C." pin unconnected.**



**DC SPECIFICATIONS (80C186EA/80C188EA)**

Symbol	Parameter	Min	Max	Units	Conditions
V <sub>CC</sub>	Supply Voltage	4.5	5.5	V	
V <sub>IL</sub>	Input Low Voltage for All Pins	-0.5	0.3 V <sub>CC</sub>	V	
V <sub>IH</sub>	Input High Voltage for All Pins	0.7 V <sub>CC</sub>	V <sub>CC</sub> + 0.5	V	
V <sub>OL</sub>	Output Low Voltage		0.45	V	I <sub>OL</sub> = 3 mA (min)
V <sub>OH</sub>	Output High Voltage	V <sub>CC</sub> - 0.5		V	I <sub>OH</sub> = -2 mA (min)
V <sub>HYR</sub>	Input Hysterisis on RESIN	0.30		V	
I <sub>IL1</sub>	Input Leakage Current (except RD/QSMD, UCS, LCS, MCS0/PEREQ, MCS1/ERROR, LOCK and TEST/BUSY)		± 10	µA	0V ≤ V <sub>IN</sub> ≤ V <sub>CC</sub>
I <sub>IL2</sub>	Input Leakage Current (RD/QSMD, UCS, LCS, MCS0/PEREQ, MCS1, ERROR, LOCK and TEST/BUSY)	-275		µA	V <sub>IN</sub> = 0.7 V <sub>CC</sub> (Note 1)
I <sub>OL</sub>	Output Leakage Current		± 10	µA	0.45 ≤ V <sub>OUT</sub> ≤ V <sub>CC</sub> (Note 2)
I <sub>CC</sub>	Supply Current Cold (RESET) 80C186EA25/80C188EA25 80C186EA20/80C188EA20 80C186EA13/80C188EA13		105 90 65	mA mA mA	(Notes 3, 5)
I <sub>ID</sub>	Supply Current In Idle Mode 80C186EA25/80C188EA25 80C186EA20/80C188EA20 80C186EA13/80C188EA13		90 70 46	mA mA mA	(Note 5)
I <sub>PD</sub>	Supply Current In Powerdown Mode 80C186EA25/80C188EA25 80C186EA20/80C188EA20 80C186EA13/80C188EA13		100 100 100	µA µA µA	(Note 5)
C <sub>OUT</sub>	Output Pin Capacitance	0	15	pF	T <sub>F</sub> = 1 MHz (Note 4)
C <sub>IN</sub>	Input Pin Capacitance	0	15	pF	T <sub>F</sub> = 1 MHz

**NOTES:**

- RD/QSMD, UCS, LCS, MCS0/PEREQ, MCS1/ERROR, LOCK and TEST/BUSY have internal pullups that are only activated during RESET. Loading these pins above I<sub>OL</sub> = -275 µA will cause the processor to enter alternate modes of operation.
- Output pins are floated using HOLD or ONCE Mode.
- Measured at worst case temperature and V<sub>CC</sub> with all outputs loaded as specified in the AC Test Conditions, and with the device in RESET (RESIN held low). RESET is worst case for I<sub>CC</sub>.
- Output capacitance is the capacitive load of a floating output pin.
- Operating conditions for 25 MHz are 0°C to +70°C, V<sub>CC</sub> = 5.0V ± 10%.

## DC SPECIFICATIONS (80L186EA/80L188EA)

Symbol	Parameter	Min	Max	Units	Conditions
V <sub>CC</sub>	Supply Voltage	2.7	5.5	V	
V <sub>IL</sub>	Input Low Voltage for All Pins	-0.5	0.3 V <sub>CC</sub>	V	
V <sub>IH</sub>	Input High Voltage for All Pins	0.7 V <sub>CC</sub>	V <sub>CC</sub> + 0.5	V	
V <sub>OL</sub>	Output Low Voltage		0.45	V	I <sub>OL</sub> = 1.6 mA (min)
V <sub>OH</sub>	Output High Voltage	V <sub>CC</sub> - 0.5		V	I <sub>OH</sub> = -1 mA (min)
V <sub>HYS</sub>	Input Hysteresis on $\overline{\text{RESIN}}$	0.30		V	
I <sub>IL1</sub>	Input Leakage Current (except RD/QSMD, UCS, LCS, MCS0/PEREQ, MCS1, LOCK and TEST)		± 10	μA	0V ≤ V <sub>IN</sub> ≤ V <sub>CC</sub>
I <sub>IL2</sub>	Input Leakage Current (RD/QSMD, UCS, LCS, MCS0, MCS1, LOCK and TEST)	-275		μA	V <sub>IN</sub> = 0.7 V <sub>CC</sub> (Note 1)
I <sub>OL</sub>	Output Leakage Current		± 10	μA	0.45 ≤ V <sub>OUT</sub> ≤ V <sub>CC</sub> (Note 2)
I <sub>CC5</sub>	Supply Current (RESET, 5.5V) 80L186EA-13 80L186EA-8		65 40	mA mA	(Note 3) (Note 3)
I <sub>CC3</sub>	Supply Current (RESET, 2.7V) 80L186EA-13 80L186EA-8		34 20	mA mA	(Note 3) (Note 3)
I <sub>ID5</sub>	Supply Current Idle (5.5V) 80L186EA-13 80L186EA-8		46 28	mA mA	
I <sub>ID3</sub>	Supply Current Idle (2.7V) 80L186EA-13 80L186EA-8		24 14	mA mA	
I <sub>PD5</sub>	Supply Current Powerdown (5.5V) 80L186EA-13 80L186EA-8		100 100	μA μA	
I <sub>PD3</sub>	Supply Current Powerdown (2.7V) 80L186EA-13 80L186EA-8		50 50	μA μA	
C <sub>OUT</sub>	Output Pin Capacitance	0	15	pF	T <sub>F</sub> = 1 MHz (Note 4)
C <sub>IN</sub>	Input Pin Capacitance	0	15	pF	T <sub>F</sub> = 1 MHz

## NOTES:

- RD/QSMD, UCS, LCS, MCS0, MCS1, LOCK and TEST have internal pullups that are only activated during RESET. Loading these pins above I<sub>OL</sub> = -275 μA will cause the processor to enter alternate modes of operation.
- Output pins are floated using HOLD or ONCE Mode.
- Measured at worst case temperature and V<sub>CC</sub> with all outputs loaded as specified in the AC Test Conditions, and with the device in RESET ( $\overline{\text{RESIN}}$  held low).
- Output capacitance is the capacitive load of a floating output pin.

**I<sub>CC</sub> VERSUS FREQUENCY AND VOLTAGE**

The current (I<sub>CC</sub>) consumption of the processor is essentially composed of two components; I<sub>PD</sub> and I<sub>CCS</sub>.

I<sub>PD</sub> is the **quiescent** current that represents internal device leakage, and is measured with all inputs or floating outputs at GND or V<sub>CC</sub> (no clock applied to the device). I<sub>PD</sub> is equal to the Powerdown current and is typically less than 50 μA.

I<sub>CCS</sub> is the **switching** current used to charge and discharge parasitic device capacitance when changing logic levels. Since I<sub>CCS</sub> is typically much greater than I<sub>PD</sub>, I<sub>PD</sub> can often be ignored when calculating I<sub>CC</sub>.

I<sub>CCS</sub> is related to the voltage and frequency at which the device is operating. It is given by the formula:

$$\text{Power} = V \times I = V^2 \times C_{DEV} \times f$$

$$\therefore I = I_{CC} = I_{CCS} = V \times C_{DEV} \times f$$

Where: V = Device operating voltage (V<sub>CC</sub>)

C<sub>DEV</sub> = Device capacitance

f = Device operating frequency

I<sub>CCS</sub> = I<sub>CC</sub> = Device current

Measuring C<sub>DEV</sub> on a device like the 80C186EA would be difficult. Instead, C<sub>DEV</sub> is calculated using the above formula by measuring I<sub>CC</sub> at a known V<sub>CC</sub> and frequency (see Table 11). Using this C<sub>DEV</sub> value, I<sub>CC</sub> can be calculated at any voltage and frequency within the specified operating range.

EXAMPLE: Calculate the typical I<sub>CC</sub> when operating at 20 MHz, 4.8V.

$$I_{CC} = I_{CCS} = 4.8 \times 0.515 \times 20 \approx 49 \text{ mA}$$

**PDTMR PIN DELAY CALCULATION**

The PDTMR pin provides a delay between the assertion of NMI and the enabling of the internal clocks when exiting Powerdown. A delay is required only when using the on-chip oscillator to allow the crystal or resonator circuit time to stabilize.

**NOTE:**

The PDTMR pin function does not apply when  $\overline{\text{RESIN}}$  is asserted (i.e., a device reset during Powerdown is similar to a cold reset and  $\overline{\text{RESIN}}$  must remain active until after the oscillator has stabilized).

To calculate the value of capacitor required to provide a desired delay, use the equation:

$$440 \times t = C_{PD} \quad (5V, 25^\circ C)$$

Where: t = desired delay in **seconds**

C<sub>PD</sub> = capacitive load on PDTMR in **microfarads**

EXAMPLE: To get a delay of 300 μs, a capacitor value of C<sub>PD</sub> = 440 × (300 × 10<sup>-6</sup>) = 0.132 μF is required. Round up to standard (available) capacitive values.

**NOTE:**

The above equation applies to delay times greater than 10 μs and will compute the **TYPICAL** capacitance needed to achieve the desired delay. A delay variance of +50% or -25% can occur due to temperature, voltage, and device process extremes. In general, higher V<sub>CC</sub> and/or lower temperature will decrease delay time, while lower V<sub>CC</sub> and/or higher temperature will increase delay time.

**Table 11. C<sub>DEV</sub> Values**

Parameter	Typ	Max	Units	Notes
C <sub>DEV</sub> (Device in Reset)	0.515	0.905	mA/V*MHz	1, 2
C <sub>DEV</sub> (Device in Idle)	0.391	0.635	mA/V*MHz	1, 2

1. Max C<sub>DEV</sub> is calculated at -40°C, all floating outputs driven to V<sub>CC</sub> or GND, and all outputs loaded to 50 pF (including CLKOUT and OSCOUT).

2. Typical C<sub>DEV</sub> is calculated at 25°C with all outputs loaded to 50 pF except CLKOUT and OSCOUT, which are not loaded.



## AC SPECIFICATIONS

## AC Characteristics—80C186EA25/80C186EA20/80C186EA13

Symbol	Parameter	Min	Max	Min	Max	Min	Max	Units	Notes
<b>INPUT CLOCK</b>		<b>25 MHz(12)</b>		<b>20 MHz</b>		<b>13 MHz</b>			
T <sub>F</sub>	CLKIN Frequency	0	50	0	40	0	26	MHz	1
T <sub>C</sub>	CLKIN Period	20	∞	25	∞	38.5	∞	ns	1
T <sub>CH</sub>	CLKIN High Time	10	∞	10	∞	12	∞	ns	1, 2
T <sub>CL</sub>	CLKIN Low Time	10	∞	10	∞	12	∞	ns	1, 2
T <sub>CR</sub>	CLKIN Rise Time	1	8	1	8	1	8	ns	1, 3
T <sub>CF</sub>	CLKIN Fall Time	1	8	1	8	1	8	ns	1, 3
<b>OUTPUT CLOCK</b>									
T <sub>CD</sub>	CLKIN to CLKOUT Delay	0	15	0	17	0	23	ns	1, 4
T	CLKOUT Period		2T <sub>C</sub>		2*T <sub>C</sub>		2*T <sub>C</sub>	ns	1
T <sub>PH</sub>	CLKOUT High Time	(T/2) - 5		(T/2) - 5		(T/2) - 5		ns	1
T <sub>PL</sub>	CLKOUT Low Time	(T/2) - 5		(T/2) - 5		(T/2) - 5		ns	1
T <sub>PR</sub>	CLKOUT Rise Time	1	6	1	6	1	6	ns	1, 5
T <sub>PF</sub>	CLKOUT Fall Time	1	6	1	6	1	6	ns	1, 5
<b>OUTPUT DELAYS</b>									
T <sub>CHOV1</sub>	ALE, S2:0, DEN, DT/R, BHE, (RFSH), LOCK, A19:16	3	20	3	22	3	25	ns	1, 4, 6, 7
T <sub>CHOV2</sub>	MCS3:0, LCS, UCS, PCS6:0, NCS, RD, WR	3	25	3	27	3	30	ns	1, 4, 6, 8
T <sub>CLOV1</sub>	BHE (RFSH), DEN, LOCK, RESOUT, HLDA, T0OUT, T1OUT, A19:16	3	20	3	22	3	25	ns	1, 4, 6
T <sub>CLOV2</sub>	RD, WR, MCS3:0, LCS, UCS, PCS6:0, AD15:0 (A15:8, AD7:0), NCS, INTA1:0, S2:0	3	25	3	27	3	30	ns	1, 4, 6
T <sub>CHOF</sub>	RD, WR, BHE (RFSH), DT/R, LOCK, S2:0, A19:16	0	25	0	25	0	25	ns	1
T <sub>CLOF</sub>	DEN, AD15:0 (A15:8, AD7:0)	0	25	0	25	0	25	ns	1

**AC SPECIFICATIONS** (Continued)

**AC Characteristics—80C186EA25/80C186EA20/80C186EA13**

Symbol	Parameter	Min	Max	Min	Max	Min	Max	Units	Notes
<b>SYNCHRONOUS INPUTS</b>		<b>25 MHz<sup>(12)</sup></b>		<b>20 MHz</b>		<b>13 MHz</b>			
T <sub>CHIS</sub>	$\overline{\text{TEST}}$ , NMI, INT3:0, T1:0IN, ARDY	8		10		10		ns	1, 9
T <sub>CHIH</sub>	$\overline{\text{TEST}}$ , NMI, INT3:0, T1:0IN, ARDY	3		3		3		ns	1, 9
T <sub>CLIS</sub>	AD15:0 (AD7:0), ARDY, SRDY, DRQ1:0	10		10		10		ns	1, 10
T <sub>CLIH</sub>	AD15:0 (AD7:0), ARDY, SRDY, DRQ1:0	3		3		3		ns	1, 10
T <sub>CLIS</sub>	HOLD, PEREQ, $\overline{\text{ERROR}}$ (80C186EA Only)	10		10		10		ns	1, 9
T <sub>CLIH</sub>	HOLD, PEREQ, $\overline{\text{ERROR}}$ (80C186EA Only)	3		3		3		ns	1, 9
T <sub>CLIS</sub>	$\overline{\text{RESIN}}$ (to CLKIN)	10		10		10		ns	1, 9
T <sub>CLIH</sub>	$\overline{\text{RESIN}}$ (from CLKIN)	3		3		3		ns	1, 9

**NOTES:**

1. See **AC Timing Waveforms**, for waveforms and definition.
  2. Measured at V<sub>IH</sub> for high time, V<sub>IL</sub> for low time.
  3. Only required to guarantee I<sub>CC</sub>. Maximum limits are bounded by T<sub>C</sub>, T<sub>CH</sub> and T<sub>CL</sub>.
  4. Specified for a 50 pF load, see Figure 13 for capacitive derating information.
  5. Specified for a 50 pF load, see Figure 14 for rise and fall times outside 50 pF.
  6. See Figure 14 for rise and fall times.
  7. T<sub>CHOV1</sub> applies to  $\overline{\text{BHE}}$  ( $\overline{\text{RFSH}}$ ),  $\overline{\text{LOCK}}$  and A19:16 only after a HOLD release.
  8. T<sub>CHOV2</sub> applies to  $\overline{\text{RD}}$  and  $\overline{\text{WR}}$  only after a HOLD release.
  9. Setup and Hold are required to guarantee recognition.
  10. Setup and Hold are required for proper operation.
  11. T<sub>CHOVS</sub> applies to  $\overline{\text{BHE}}$  ( $\overline{\text{RFSH}}$ ) and A19:16 only after a HOLD release.
  12. Operating conditions for 25 MHz are 0°C to +70°C, V<sub>CC</sub> = 5.0V ±10%.
- Pin names in parentheses apply to the 80C188EA/80L188EA.

1

## AC SPECIFICATIONS

## AC Characteristics—80L186EA13/80L186EA8

Symbol	Parameter	Min	Max	Min	Max	Units	Notes
<b>INPUT CLOCK</b>		<b>13 MHz</b>		<b>8 MHz</b>			
T <sub>F</sub>	CLKIN Frequency	0	26	0	16	MHz	1
T <sub>C</sub>	CLKIN Period	38.5	∞	62.5	∞	ns	1
T <sub>CH</sub>	CLKIN High Time	12	∞	12	∞	ns	1, 2
T <sub>CL</sub>	CLKIN Low Time	12	∞	12	∞	ns	1, 2
T <sub>CR</sub>	CLKIN Rise Time	1	8	1	8	ns	1, 3
T <sub>CF</sub>	CLKIN Fall Time	1	8	1	8	ns	1, 3
<b>OUTPUT CLOCK</b>							
T <sub>CD</sub>	CLKIN to CLKOUT Delay	0	45	0	95	ns	1, 4
T	CLKOUT Period		2*T <sub>C</sub>		2*T <sub>C</sub>	ns	1
T <sub>PH</sub>	CLKOUT High Time	(T/2) - 5		(T/2) - 5		ns	1
T <sub>PL</sub>	CLKOUT Low Time	(T/2) - 5		(T/2) - 5		ns	1
T <sub>PR</sub>	CLKOUT Rise Time	1	12	1	12	ns	1, 5
T <sub>PF</sub>	CLKOUT Fall Time	1	12	1	12	ns	1, 5
<b>OUTPUT DELAYS</b>							
T <sub>CHOV1</sub>	ALE, LOCK	3	27	3	27	ns	1, 4, 6, 7
T <sub>CHOV2</sub>	MCS3:0, LCS, UCS, PCS6:0, RD, WR	3	32	3	32	ns	1, 4, 6, 8
T <sub>CHOV3</sub>	S2:0 (DEN), DT/R, BHE (RFSH), A19:16	3	30	3	30	ns	1
T <sub>CLOV1</sub>	LOCK, RESOUT, HLDA, TOOUT, T1OUT	3	27	3	27	ns	1, 4, 6
T <sub>CLOV2</sub>	RD, WR, MCS3:0, LCS, UCS, PCS6:0, INTA1:0	3	32	3	35	ns	1, 4, 6
T <sub>CLOV3</sub>	BHE (RFSH), DEN, A19:16	3	30	3	30	ns	1, 4, 6
T <sub>CLOV4</sub>	AD15:0 (A15:8, AD7:0)	3	34	3	35	ns	1, 4, 6
T <sub>CLOV5</sub>	S2:0	3	38	3	40	ns	1, 4, 6
T <sub>CHOF</sub>	RD, WR, BHE (RFSH), DT/R, LOCK, S2:0, A19:16	0	27	0	27	ns	1
T <sub>CLOF</sub>	DEN, AD15:0 (A15:8, AD7:0)	0	27	0	27	ns	1

## NOTES:

1. See **AC Timing Waveforms**, for waveforms and definition.
2. Measured at V<sub>IH</sub> for high time, V<sub>IL</sub> for low time.
3. Only required to guarantee I<sub>CC</sub>. Maximum limits are bounded by T<sub>C</sub>, T<sub>CH</sub> and T<sub>CL</sub>.
4. Specified for a 50 pF load, see Figure 13 for capacitive derating information.
5. Specified for a 50 pF load, see Figure 14 for rise and fall times outside 50 pF.
6. See Figure 14 for rise and fall times.
7. T<sub>CHOV1</sub> applies to BHE (RFSH), LOCK and A19:16 only after a HOLD release.
8. T<sub>CHOV2</sub> applies to RD and WR only after a HOLD release.
9. Setup and Hold are required to guarantee recognition.
10. Setup and Hold are required for proper operation.
11. T<sub>CHOV5</sub> applies to BHE (RFSH) and A19:16 only after a HOLD release.
12. Pin names in parentheses apply to the 80C188EA/80L188EA.



## AC SPECIFICATIONS

## AC Characteristics—80L186EA13/80L186EA8

Symbol	Parameter	Min	Max	Min	Max	Units	Notes
<b>SYNCHRONOUS INPUTS</b>		<b>13 MHz</b>		<b>8 MHz</b>			
$T_{CHIS}$	$\overline{TEST}$ , NMI, INT3:0, T1:0IN, ARDY	22		22		ns	1, 9
$T_{CHIH}$	$\overline{TEST}$ , NMI, INT3:0, T1:0IN, ARDY	3		3		ns	1, 9
$T_{CLIS}$	AD15:0 (AD7:0), ARDY, SRDY, DRQ1:0	22		22		ns	1, 10
$T_{CLIH}$	AD15:0 (AD7:0), ARDY, SRDY, DRQ1:0	3		3		ns	1, 10
$T_{CLIS}$	HOLD	22		22		ns	1, 9
$T_{CLIH}$	HOLD	3		3		ns	1, 9
$T_{CLIS}$	$\overline{RESIN}$ (to CLKIN)	22		22		ns	1, 9
$T_{CLIH}$	$\overline{RESIN}$ (from CLKIN)	3		3		ns	1, 9

## NOTES:

1. See **AC Timing Waveforms**, for waveforms and definition.
2. Measured at  $V_{IH}$  for high time,  $V_{IL}$  for low time.
3. Only required to guarantee  $I_{CC}$ . Maximum limits are bounded by  $T_C$ ,  $T_{CH}$  and  $T_{CL}$ .
4. Specified for a 50 pF load, see Figure 13 for capacitive derating information.
5. Specified for a 50 pF load, see Figure 14 for rise and fall times outside 50 pF.
6. See Figure 14 for rise and fall times.
7.  $T_{CHOV1}$  applies to  $\overline{BHE}$  (RFSH),  $\overline{LOCK}$  and A19:16 only after a HOLD release.
8.  $T_{CHOV2}$  applies to  $\overline{RD}$  and  $\overline{WR}$  only after a HOLD release.
9. Setup and Hold are required to guarantee recognition.
10. Setup and Hold are required for proper operation.
11.  $T_{CHOVS}$  applies to  $\overline{BHE}$  (RFSH) and A19:16 only after a HOLD release.
12. Pin names in parentheses apply to the 80C188EA/80L188EA.

1

## AC SPECIFICATIONS (Continued)

## Relative Timings (80C186EA25/20/13, 80L186EA13/8)

Symbol	Parameter	Min	Max	Unit	Notes
<b>RELATIVE TIMINGS</b>					
$T_{LHLL}$	ALE Rising to ALE Falling	$T - 15$		ns	
$T_{AVLL}$	Address Valid to ALE Falling	$\frac{1}{2}T - 10$		ns	
$T_{PLLL}$	Chip Selects Valid to ALE Falling	$\frac{1}{2}T - 10$		ns	1
$T_{LLAX}$	Address Hold from ALE Falling	$\frac{1}{2}T - 10$		ns	
$T_{LLWL}$	ALE Falling to $\overline{WR}$ Falling	$\frac{1}{2}T - 15$		ns	1
$T_{LLRL}$	ALE Falling to $\overline{RD}$ Falling	$\frac{1}{2}T - 15$		ns	1
$T_{RHLH}$	$\overline{RD}$ Rising to ALE Rising	$\frac{1}{2}T - 10$		ns	1
$T_{WHLH}$	$\overline{WR}$ Rising to ALE Rising	$\frac{1}{2}T - 10$		ns	1
$T_{AFRL}$	Address Float to $\overline{RD}$ Falling	0		ns	
$T_{RLRH}$	$\overline{RD}$ Falling to $\overline{RD}$ Rising	$(2^*T) - 5$		ns	2
$T_{WLWH}$	$\overline{WR}$ Falling to $\overline{WR}$ Rising	$(2^*T) - 5$		ns	2
$T_{RHAV}$	$\overline{RD}$ Rising to Address Active	$T - 15$		ns	
$T_{WHDX}$	Output Data Hold after $\overline{WR}$ Rising	$T - 15$		ns	
$T_{WHDEX}$	$\overline{WR}$ Rising to $\overline{DEN}$ Rising	$\frac{1}{2}T - 10$		ns	1
$T_{WHPH}$	$\overline{WR}$ Rising to Chip Select Rising	$\frac{1}{2}T - 10$		ns	1, 4
$T_{RHPH}$	$\overline{RD}$ Rising to Chip Select Rising	$\frac{1}{2}T - 10$		ns	1, 4
$T_{PHPL}$	$\overline{CS}$ Inactive to $\overline{CS}$ Active	$\frac{1}{2}T - 10$		ns	1
$T_{DXDL}$	$\overline{DEN}$ Inactive to $\overline{DT}/\overline{R}$ Low	0		ns	5
$T_{OVRH}$	ONCE ( $\overline{UCS}$ , $\overline{LCS}$ ) Active to $\overline{RESIN}$ Rising	$T$		ns	3
$T_{RHOX}$	ONCE ( $\overline{UCS}$ , $\overline{LCS}$ ) to $\overline{RESIN}$ Rising	$T$		ns	3

## NOTES:

1. Assumes equal loading on both pins.
2. Can be extended using wait states.
3. Not tested.
4. Not applicable to latched A2:1. These signals change only on falling  $T_1$ .
5. For write cycle followed by read cycle.
6. Operating conditions for 25 MHz are 0°C to +70°C,  $V_{CC} = 5.0V \pm 10\%$ .

### AC TEST CONDITIONS

The AC specifications are tested with the 50 pF load shown in Figure 8. See the Derating Curves section to see how timings vary with load capacitance.

Specifications are measured at the  $V_{CC}/2$  crossing point, unless otherwise specified. See AC Timing Waveforms, for AC specification definitions, test pins, and illustrations.

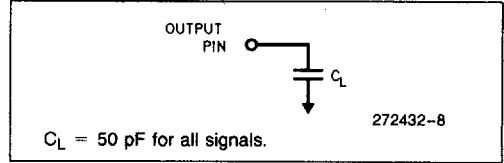

Figure 8. AC Test Load

### AC TIMING WAVEFORMS

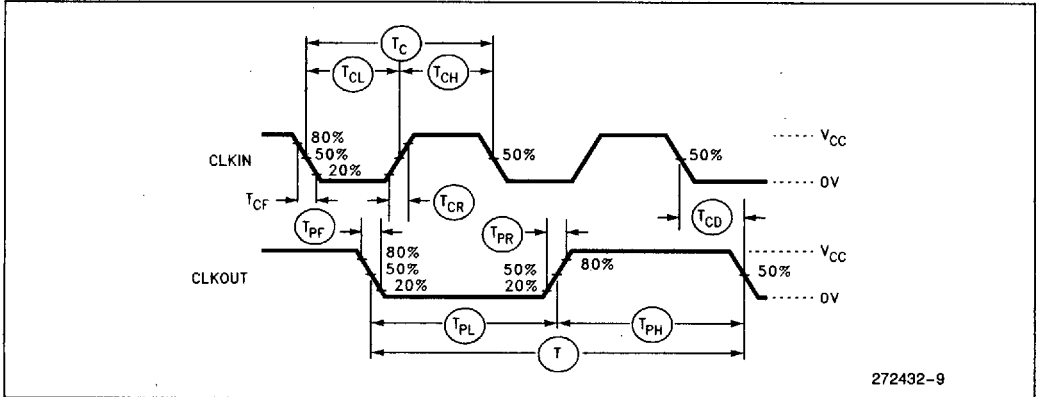

Figure 9. Input and Output Clock Waveform

1

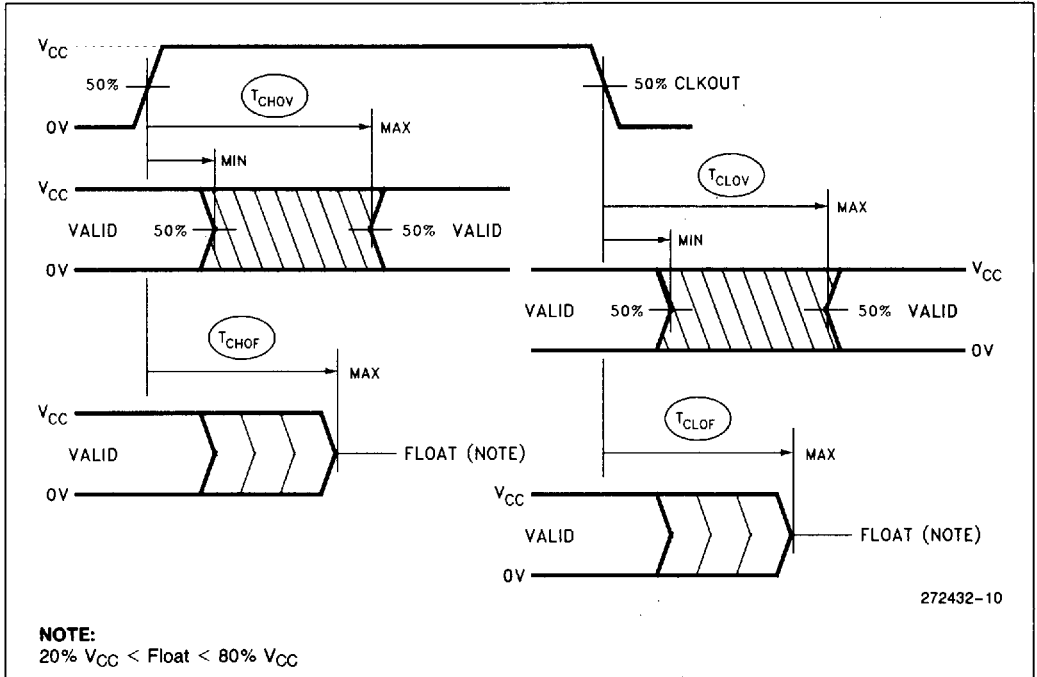

Figure 10. Output Delay and Float Waveform

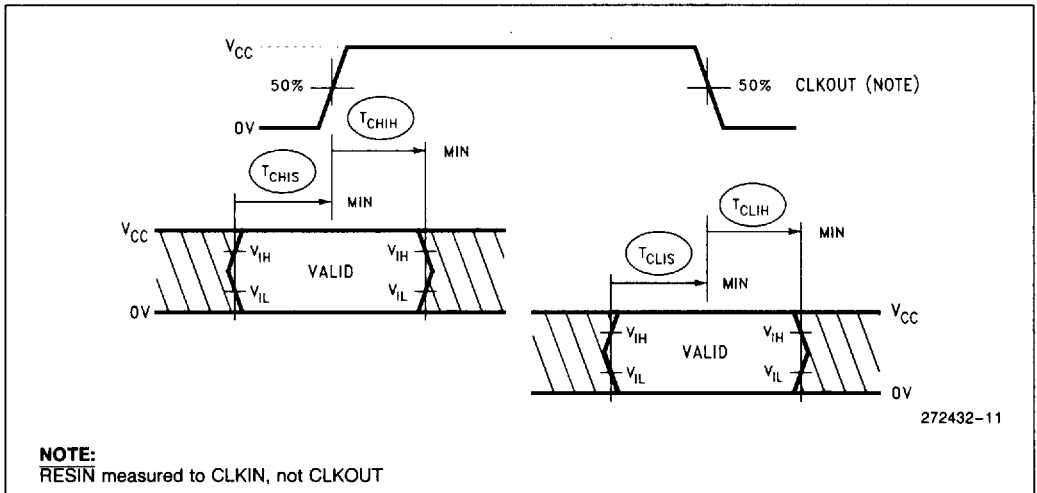

Figure 11. Input Setup and Hold

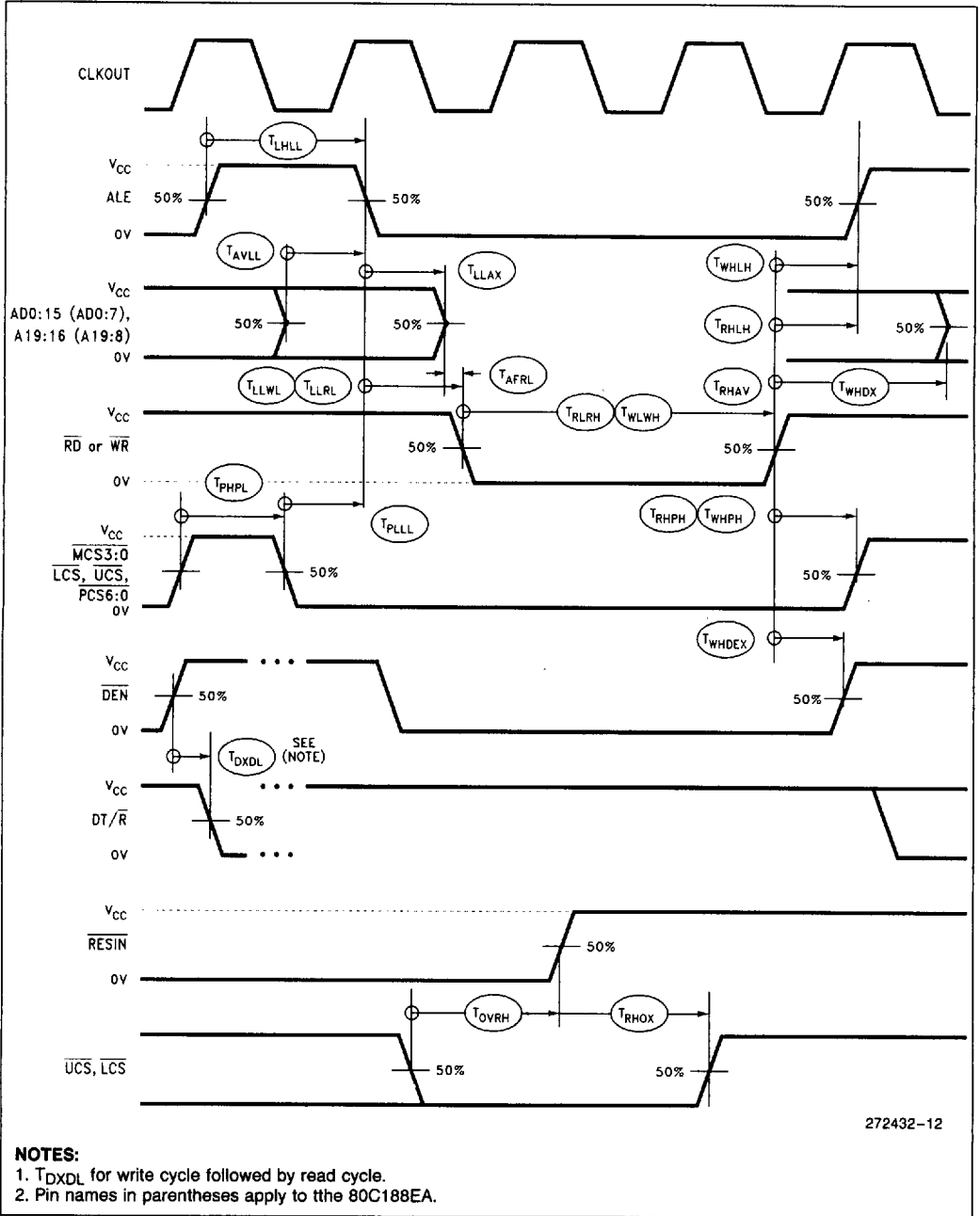

Figure 12. Relative Signal Waveform



DERATING CURVES

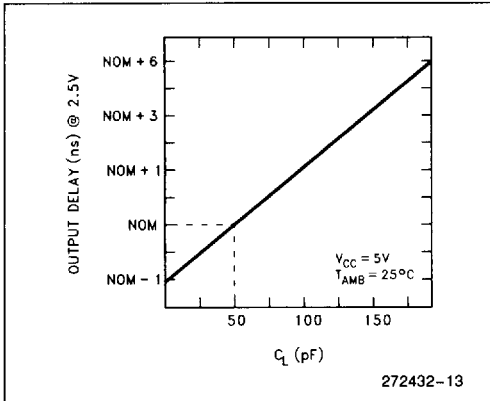

Figure 13. Typical Output Delay Variations Versus Load Capacitance

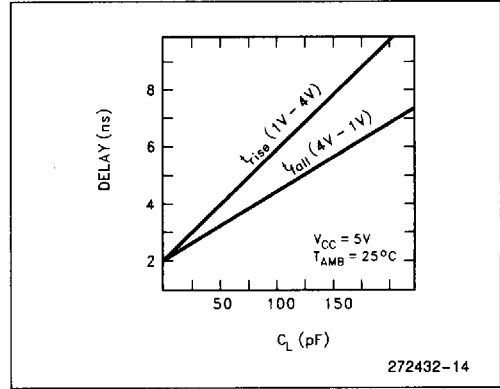

Figure 14. Typical Rise and Fall Variations Versus Load Capacitance

RESET

The processor performs a reset operation any time the  $\overline{\text{RESIN}}$  pin is active. The  $\overline{\text{RESIN}}$  pin is actually synchronized before it is presented internally, which means that the clock must be operating before a reset can take effect. From a power-on state,  $\overline{\text{RESIN}}$  must be held active (low) in order to guarantee correct initialization of the processor. **Failure to provide  $\overline{\text{RESIN}}$  while the device is powering up will result in unspecified operation of the device.**

Figure 15 shows the correct reset sequence when first applying power to the processor. An external clock connected to CLKIN must not exceed the  $V_{CC}$  threshold being applied to the processor. This is normally not a problem if the clock driver is supplied with the same  $V_{CC}$  that supplies the processor. When attaching a crystal to the device,  $\overline{\text{RESIN}}$  must remain active until both  $V_{CC}$  and CLKOUT are stable (the length of time is application specific and depends on the startup characteristics of the crystal circuit). The  $\overline{\text{RESIN}}$  pin is designed to operate correctly using an RC reset circuit, but the designer

must ensure that the ramp time for  $V_{CC}$  is not so long that  $\overline{\text{RESIN}}$  is never really sampled at a logic low level when  $V_{CC}$  reaches minimum operating conditions.

Figure 16 shows the timing sequence when  $\overline{\text{RESIN}}$  is applied after  $V_{CC}$  is stable and the device has been operating. Note that a reset will terminate all activity and return the processor to a known operating state. Any bus operation that is in progress at the time  $\overline{\text{RESIN}}$  is asserted will terminate immediately (note that most control signals will be driven to their inactive state first before floating).

While  $\overline{\text{RESIN}}$  is active, signals  $\overline{\text{RD}}/\overline{\text{QSMD}}$ ,  $\overline{\text{UCS}}$ ,  $\overline{\text{LCS}}$ ,  $\overline{\text{MCS0}}/\overline{\text{PEREQ}}$ ,  $\overline{\text{MCS1}}/\overline{\text{ERROR}}$ ,  $\overline{\text{LOCK}}$ , and  $\overline{\text{TEST}}/\overline{\text{BUSY}}$  are configured as inputs and weakly held high by internal pullup transistors. Forcing  $\overline{\text{UCS}}$  and  $\overline{\text{LCS}}$  low selects ONCE Mode. Forcing  $\overline{\text{QSMD}}$  low selects Queue Status Mode. Forcing  $\overline{\text{TEST}}/\overline{\text{BUSY}}$  high at reset and low four clocks later enables Numerics Mode. Forcing  $\overline{\text{LOCK}}$  low is prohibited and results in unspecified operation.

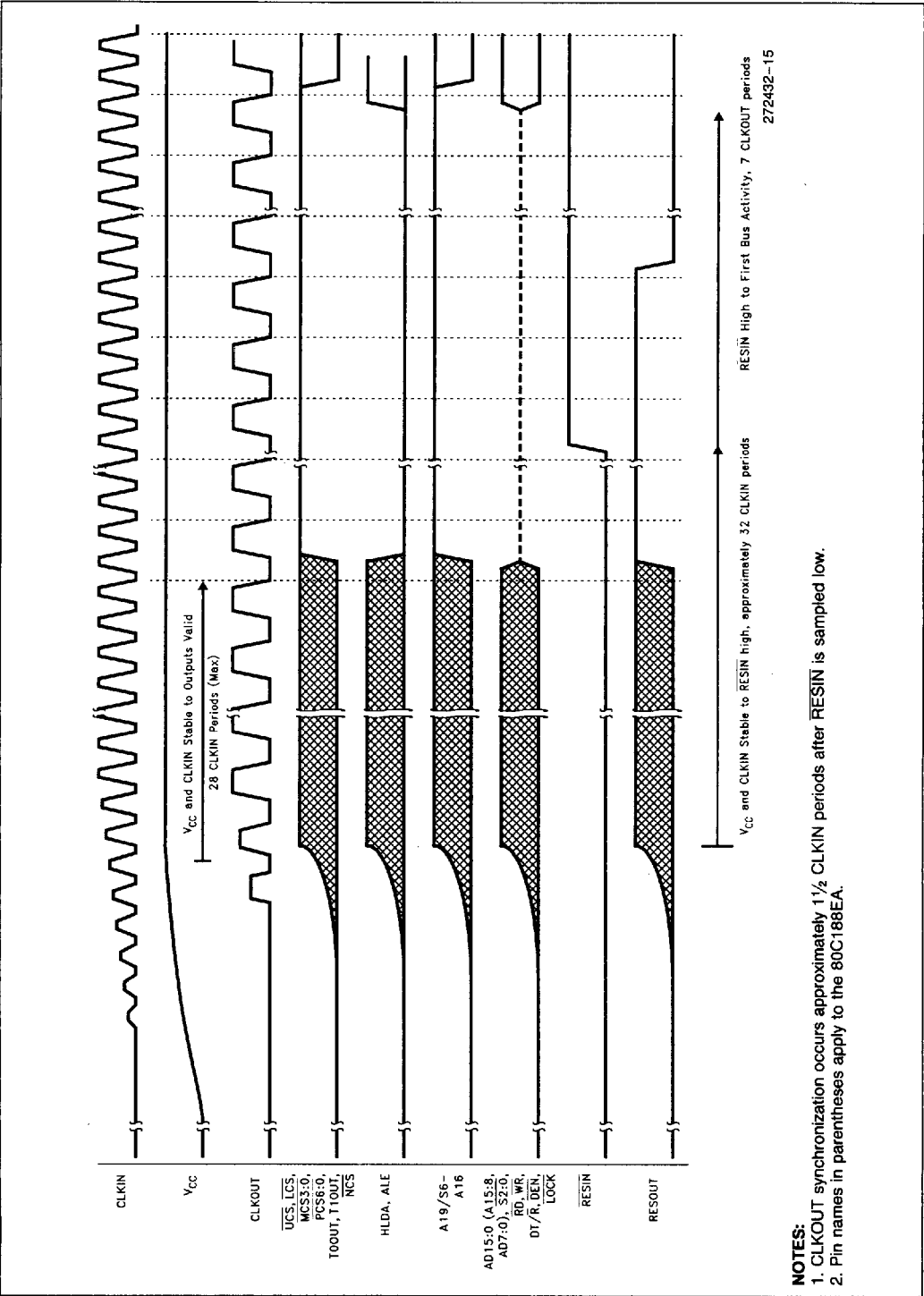

Figure 15. Powerup Reset Waveforms

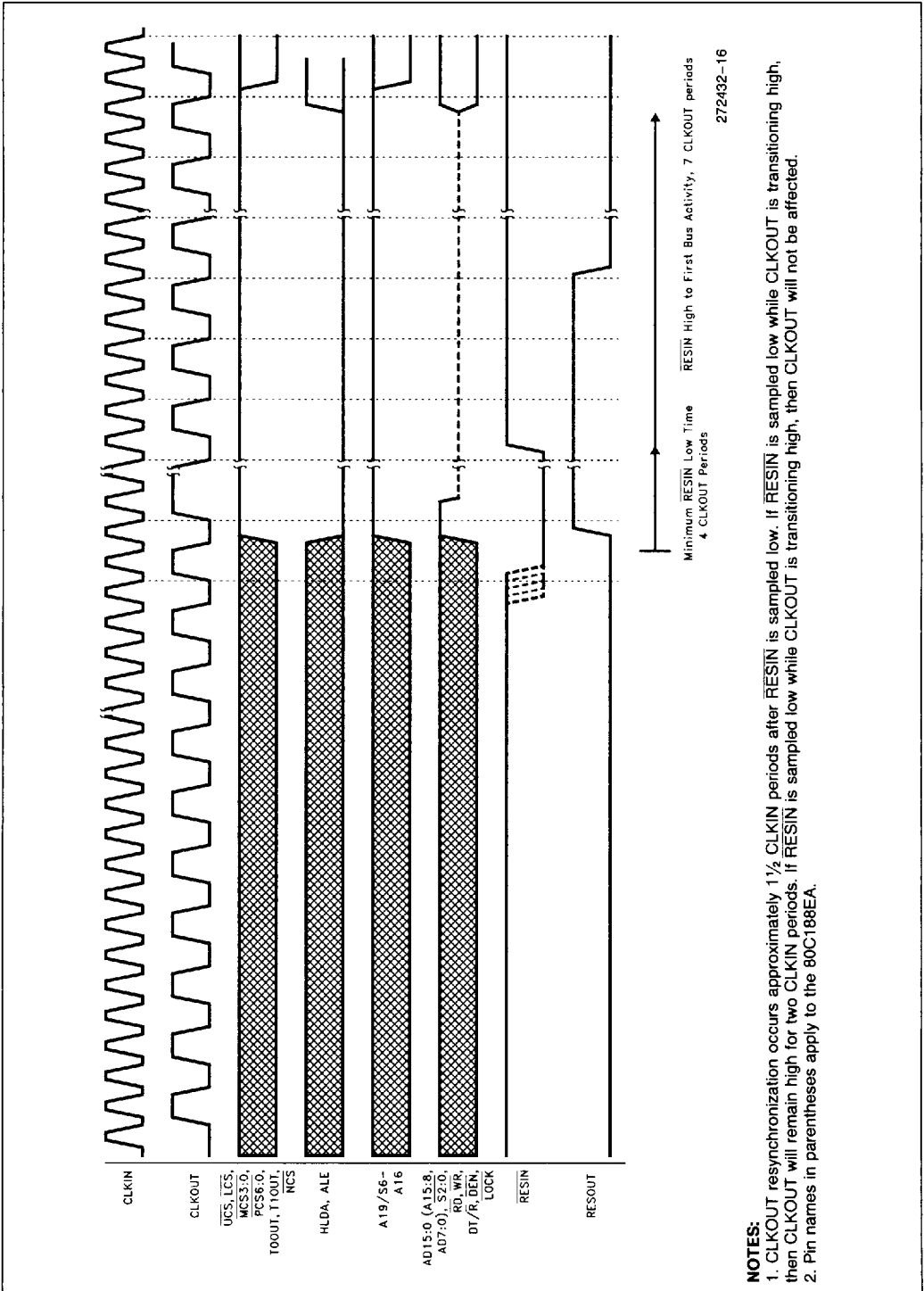
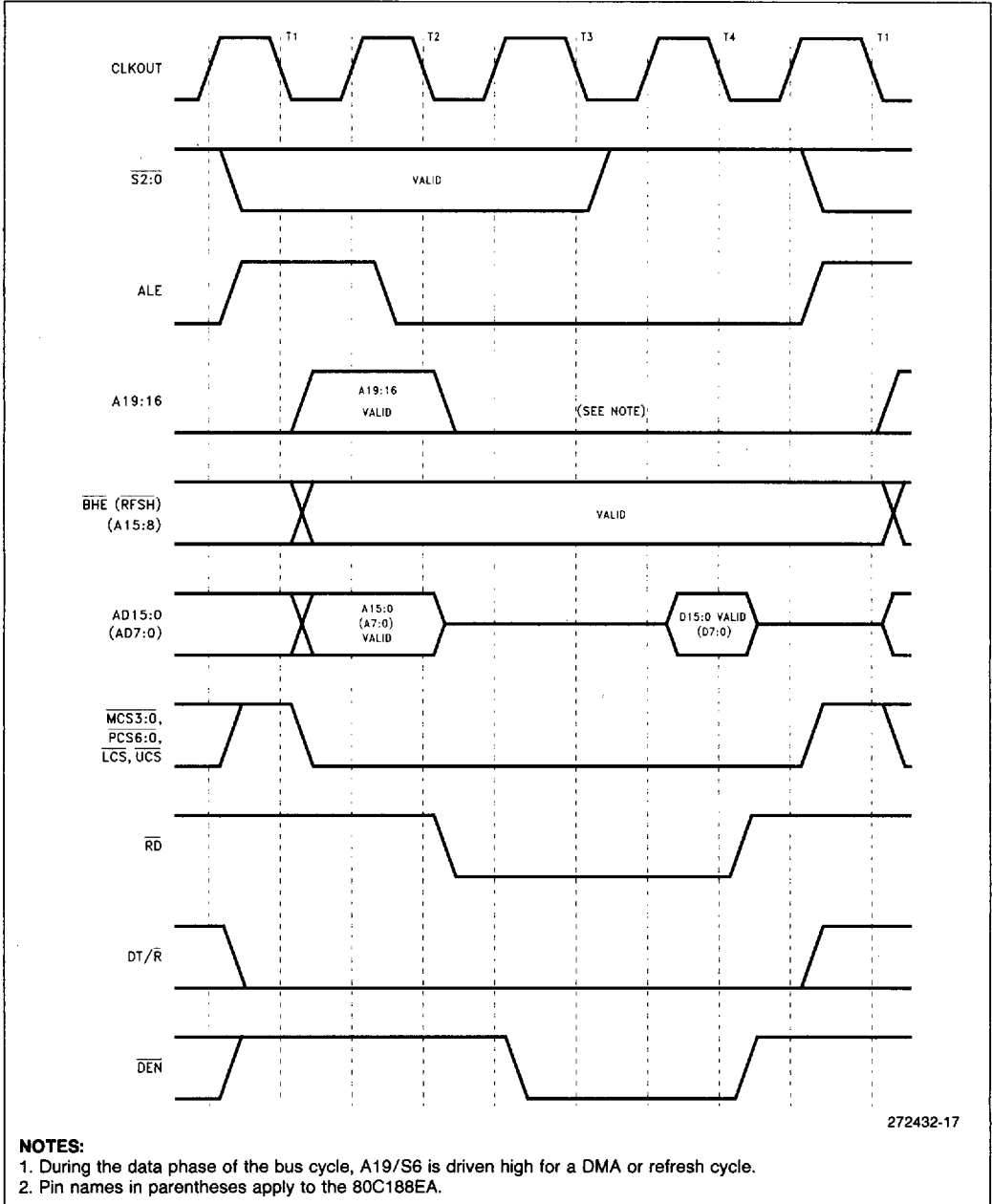

Figure 16. Warm Reset Waveforms

**NOTES:**  
 1. CLKOUT resynchronization occurs approximately 1½ CLKIN periods after RESIN is sampled low. If RESIN is sampled low while CLKOUT is transitioning high, then CLKOUT will remain high for two CLKIN periods. If RESIN is sampled low while CLKOUT is transitioning high, then CLKOUT will not be affected.  
 2. Pin names in parentheses apply to the 80C188EA.

**BUS CYCLE WAVEFORMS**

Figures 17 through 23 present the various bus cycles that are generated by the processor. What is shown in the figure is the relationship of the various bus signals to CLKOUT. These figures along with the information present in **AC Specifications** allow the user to determine all the critical timing analysis needed for a given application.



**Figure 17. Read, Fetch and Refresh Cycle Waveform**

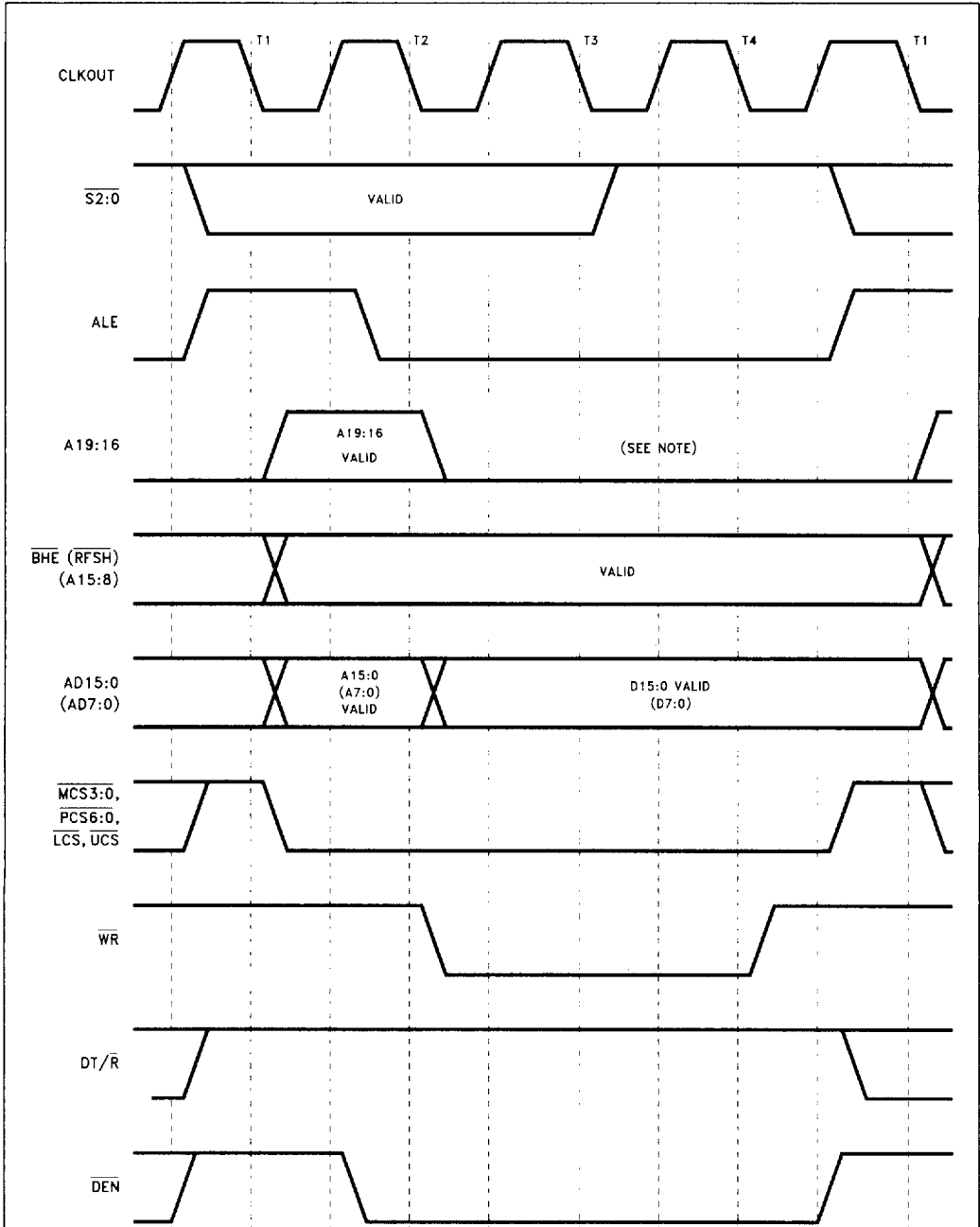

272432-18

**NOTES:**

1. During the data phase of the bus cycle, A19/S6 is driven high for a DMA cycle.
2. Pin names in parentheses apply to the 80C188EA.

**Figure 18. Write Cycle Waveform**

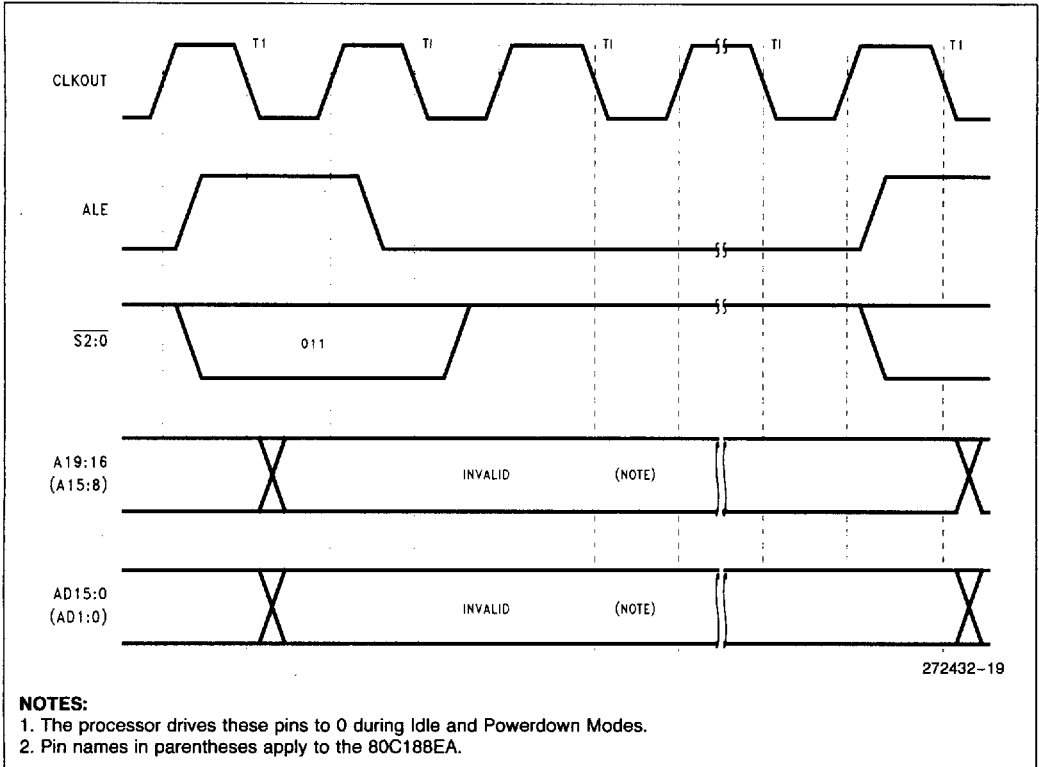
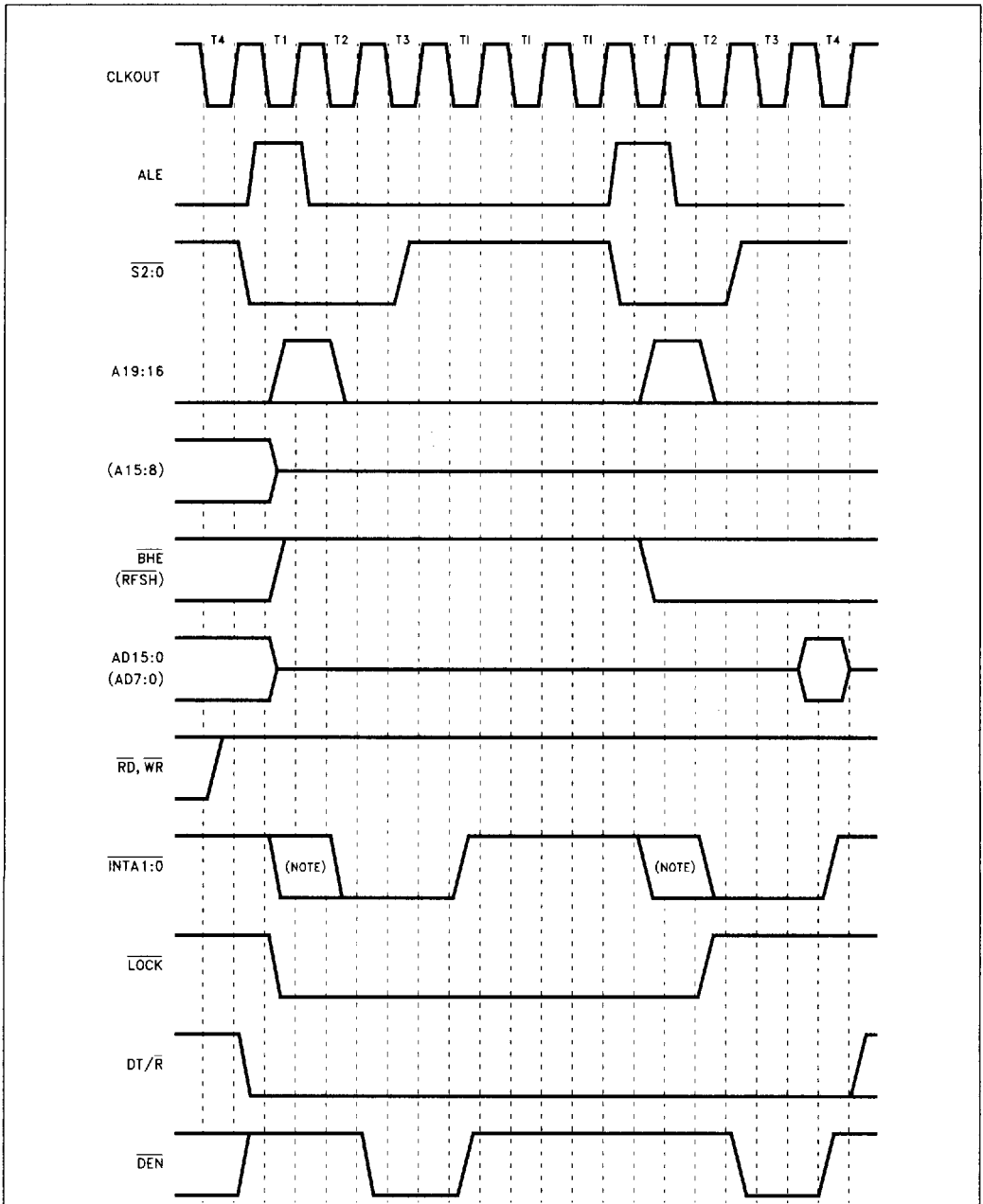

Figure 19. Halt Cycle Waveform



**NOTES:**

1.  $\overline{INTA}$  occurs one clock later in Slave Mode.
2. Pin names in parentheses apply to the 80C188EA.

272432-20

**Figure 20.  $\overline{INTA}$  Cycle Waveform**

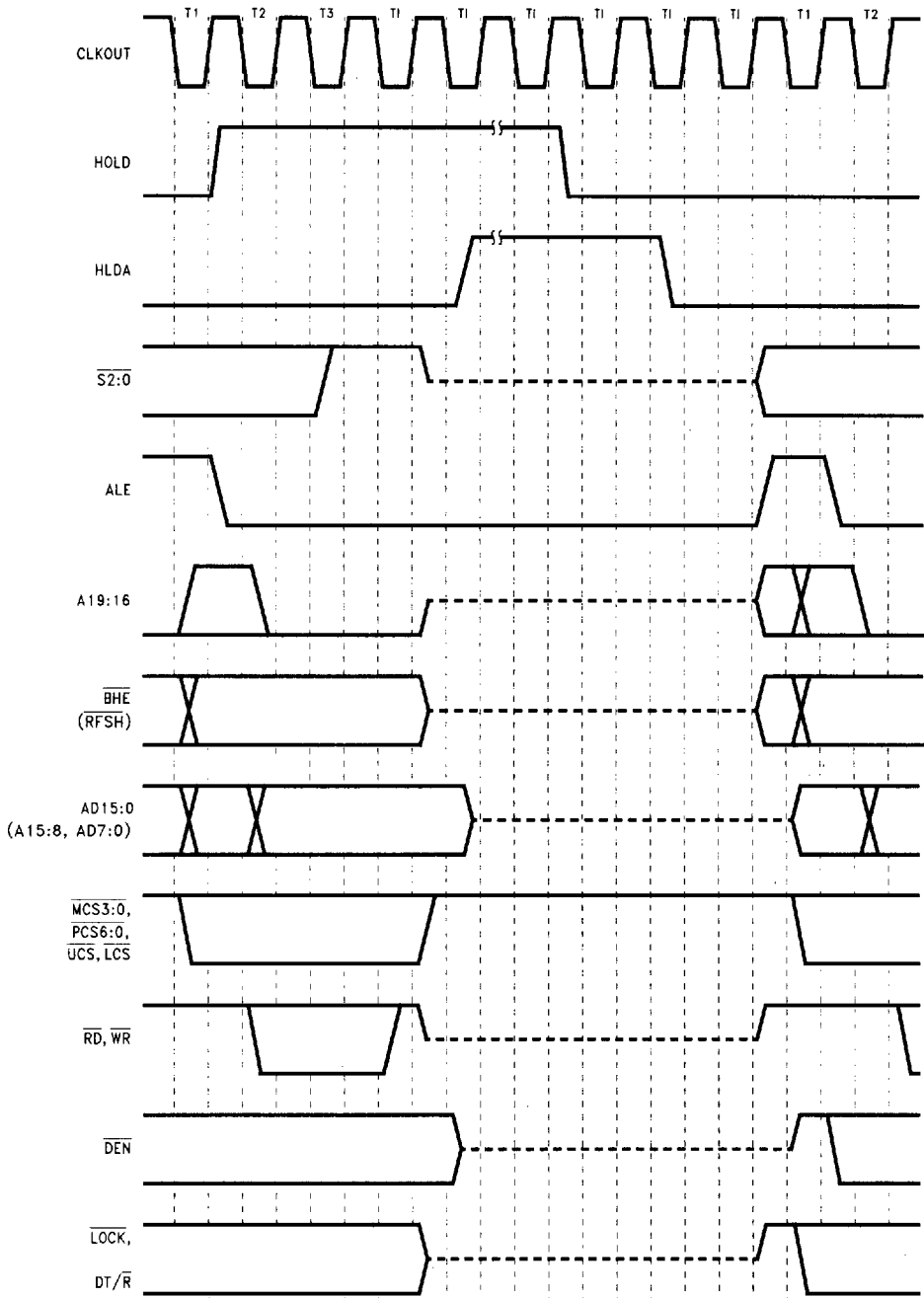

272432-21

**NOTE:**

1. Pin names in parentheses apply to the 80C188EA.

**Figure 21. HOLD/HLDA Waveform**



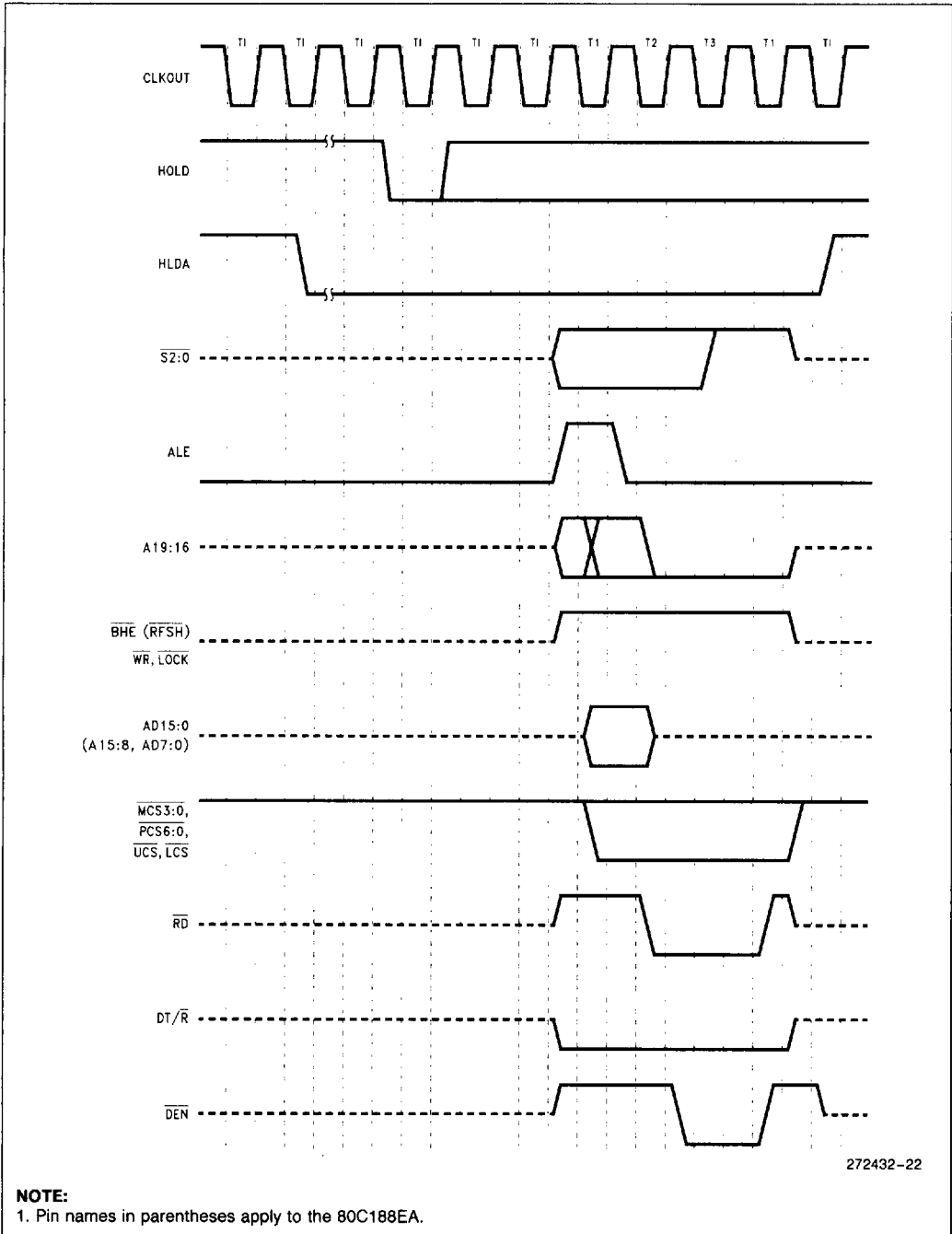
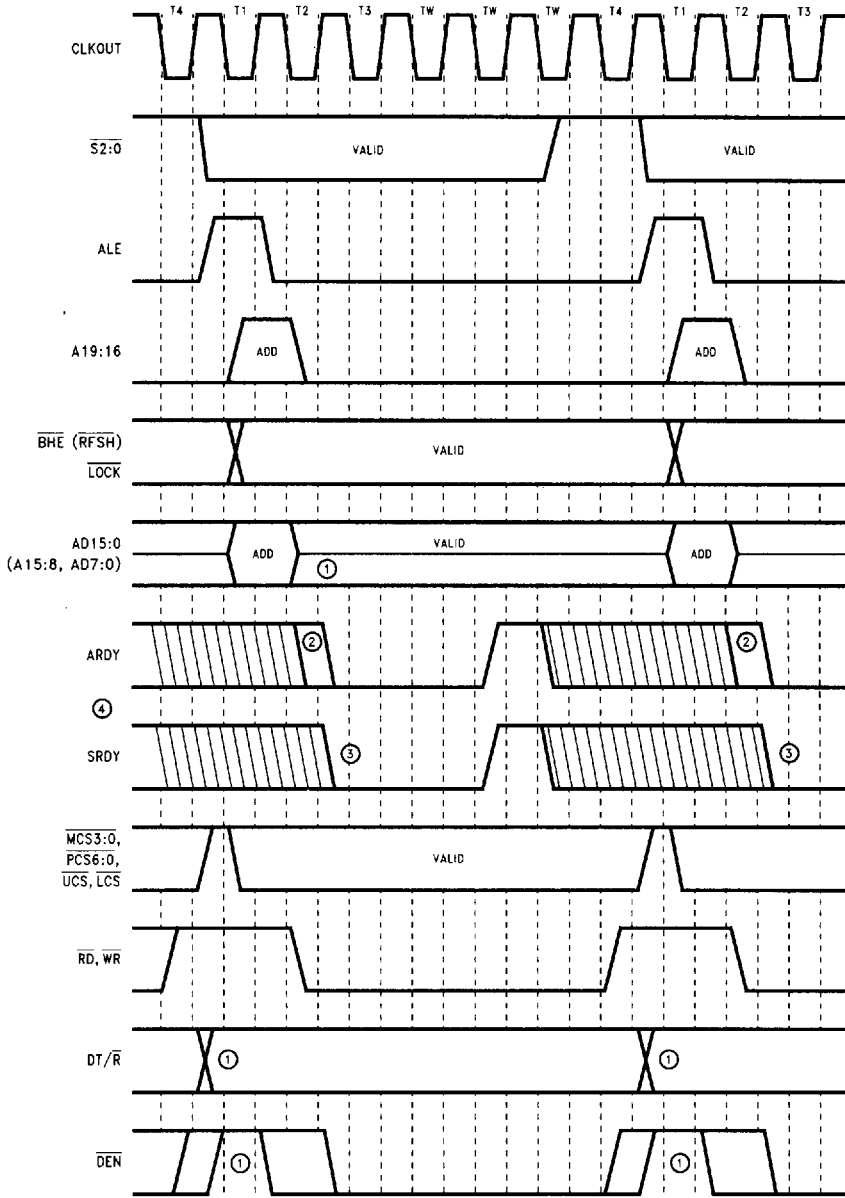

Figure 22. DRAM Refresh Cycle During Hold Acknowledge



272432-23

**NOTES:**

1. Generalized diagram for READ or WRITE.
2. ARDY low by either edge causes a wait state. Only rising ARDY is fully synchronized.
3. SRDY low causes a wait state. SRDY must meet setup and hold times to ensure correct device operation.
4. Either ARDY or SRDY active high will terminate a bus cycle.
5. Pin names in parentheses apply to the 80C188EA.

**Figure 23. Ready Waveform**

## 80C186EA/80C188EA EXECUTION TIMINGS

A determination of program execution timing must consider the bus cycles necessary to prefetch instructions as well as the number of execution unit cycles necessary to execute instructions. The following instruction timings represent the **minimum** execution time in clock cycle for each instruction. The timings given are based on the following assumptions:

- The opcode, along with any data or displacement required for execution of a particular instruction, has been prefetched and resides in the queue at the time it is needed.
- No wait states or bus HOLDs occur.
- All word-data is located on even-address boundaries. (80C186EA only)

All jumps and calls include the time required to fetch the opcode of the next instruction at the destination address.

All instructions which involve memory accesses can require one or two additional clocks above the minimum timings shown due to the asynchronous handshake between the bus interface unit (BIU) and execution unit.

With a 16-bit BIU, the 80C186EA has sufficient bus performance to endure that an adequate number of prefetched bytes will reside in the queue (6 bytes) most of the time. Therefore, actual program execution time will not be substantially greater than that derived from adding the instruction timings shown.

The 80C188EA 8-bit BIU is limited in its performance relative to the execution unit. A sufficient number of prefetched bytes may not reside in the prefetch queue (4 bytes) much of the time. Therefore, actual program execution time will be substantially greater than that derived from adding the instruction timings shown.



**INSTRUCTION SET SUMMARY**

Function	Format	80C186EA Clock Cycles	80C188EA Clock Cycles	Comments
<b>DATA TRANSFER</b>				
<b>MOV = Move:</b>				
Register to Register/Memory	1 000 100 w mod reg r/m	2/12	2/12*	
Register/memory to register	1 000 101 w mod reg r/m	2/9	2/9	
Immediate to register/memory	1 100 011 w mod 000 r/m data data if w=1	12-13	12-13	8/16-bit
Immediate to register	1 011 w reg data data if w=1	3-4	3-4	8/16-bit
Memory to accumulator	1 010 000 w addr-low addr-high	8	8*	
Accumulator to memory	1 010 001 w addr-low addr-high	9	9*	
Register/memory to segment register	1 000 111 0 mod 0 reg r/m	2/9	2/13	
Segment register to register/memory	1 000 110 0 mod 0 reg r/m	2/11	2/15	
<b>PUSH = Push:</b>				
Memory	1 111 111 1 mod 110 r/m	16	20	
Register	0 101 0 reg	10	14	
Segment register	0 00 reg 110	9	13	
Immediate	0 110 10 s 0 data data if s=0	10	14	
<b>PUSHA = Push All</b>				
0 110 000 0		36	66	
<b>POP = Pop:</b>				
Memory	1 000 111 1 mod 000 r/m	20	24	
Register	0 101 1 reg	10	14	
Segment register	0 00 reg 111 (reg≠01)	8	12	
<b>POPA = Pop All</b>				
0 110 000 1		61	83	
<b>XCHG = Exchange:</b>				
Register/memory with register	1 000 011 w mod reg r/m	4/17	4/17*	
Register with accumulator	1 001 0 reg	3	3	
<b>IN = Input from:</b>				
Fixed port	1 110 010 w port	10	10*	
Variable port	1 110 110 w	8	7*	
<b>OUT = Output to:</b>				
Fixed port	1 110 011 w port	9	9*	
Variable port	1 110 111 w	7	7*	
<b>XLAT = Translate byte to AL</b>	1 101 011 1	11	15	
<b>LEA = Load EA to register</b>	1 000 110 1 mod reg r/m	6	6	
<b>LDS = Load pointer to DS</b>	1 100 010 1 mod reg r/m	18	26	(mod≠11)
<b>LES = Load pointer to ES</b>	1 100 010 0 mod reg r/m	18	26	(mod≠11)
<b>LAHF = Load AH with flags</b>	1 001 111 1	2	2	
<b>SAHF = Store AH into flags</b>	1 001 111 0	3	3	
<b>PUSHF = Push flags</b>	1 001 110 0	9	13	
<b>POPF = Pop flags</b>	1 001 110 1	8	12	

Shaded areas indicate instructions not available in 8086/8088 microsystems.

**NOTE:**

\*Clock cycles shown for byte transfers. For word operations, add 4 clock cycles for all memory transfers.



## INSTRUCTION SET SUMMARY (Continued)

Function	Format	80C186EA Clock Cycles	80C188EA Clock Cycles	Comments
<b>DATA TRANSFER (Continued)</b>				
<b>SEGMENT = Segment Override:</b>				
CS	00101110	2	2	
SS	00110110	2	2	
DS	00111110	2	2	
ES	00100110	2	2	
<b>ARITHMETIC</b>				
<b>ADD = Add:</b>				
Reg/memory with register to either	000000d w mod reg r/m	3/10	3/10*	
Immediate to register/memory	100000s w mod 000 r/m data data if s w = 01	4/16	4/16*	
Immediate to accumulator	0000010 w data data if w = 1	3/4	3/4	8/16-bit
<b>ADC = Add with carry:</b>				
Reg/memory with register to either	000100d w mod reg r/m	3/10	3/10*	
Immediate to register/memory	100000s w mod 010 r/m data data if s w = 01	4/16	4/16*	
Immediate to accumulator	0001010 w data data if w = 1	3/4	3/4	8/16-bit
<b>INC = Increment:</b>				
Register/memory	1111111 w mod 000 r/m	3/15	3/15*	
Register	01000 reg	3	3	
<b>SUB = Subtract:</b>				
Reg/memory and register to either	001010d w mod reg r/m	3/10	3/10*	
Immediate from register/memory	100000s w mod 101 r/m data data if s w = 01	4/16	4/16*	
Immediate from accumulator	0010110 w data data if w = 1	3/4	3/4	8/16-bit
<b>SBB = Subtract with borrow:</b>				
Reg/memory and register to either	000110d w mod reg r/m	3/10	3/10*	
Immediate from register/memory	100000s w mod 011 r/m data data if s w = 01	4/16	4/16*	
Immediate from accumulator	0001110 w data data if w = 1	3/4	3/4*	8/16-bit
<b>DEC = Decrement</b>				
Register/memory	1111111 w mod 001 r/m	3/15	3/15*	
Register	01001 reg	3	3	
<b>CMP = Compare:</b>				
Register/memory with register	0011101 w mod reg r/m	3/10	3/10*	
Register with register/memory	0011100 w mod reg r/m	3/10	3/10*	
Immediate with register/memory	100000s w mod 111 r/m data data if s w = 01	3/10	3/10*	
Immediate with accumulator	0011110 w data data if w = 1	3/4	3/4	8/16-bit
<b>NEG = Change sign register/memory</b>				
	1111011 w mod 011 r/m	3/10*	3/10*	
<b>AAA = ASCII adjust for add</b>				
	00110111	8	8	
<b>DAA = Decimal adjust for add</b>				
	00100111	4	4	
<b>AAS = ASCII adjust for subtract</b>				
	00111111	7	7	
<b>DAS = Decimal adjust for subtract</b>				
	00101111	4	4	
<b>MUL = Multiply (unsigned):</b>				
	1111011 w mod 100 r/m			
Register-Byte		26-28	26-28	
Register-Word		35-37	35-37	
Memory-Byte		32-34	32-34	
Memory-Word		41-43	41-48*	

Shaded areas indicate instructions not available in 8086/8088 microsystems.

**NOTE:**

\*Clock cycles shown for byte transfers. For word operations, add 4 clock cycles for all memory transfers.



**INSTRUCTION SET SUMMARY (Continued)**

Function	Format	80C186EA Clock Cycles	80C188EA Clock Cycles	Comments
<b>ARITHMETIC (Continued)</b>				
<b>IMUL</b> = Integer multiply (signed):	1111011w   mod101 r/m			
Register-Byte		25-28	25-28	
Register-Word		34-37	34-37	
Memory-Byte		31-34	32-34	
Memory-Word		40-43	40-43*	
<b>IMUL</b> = Integer immediate multiply (signed)	011010s1   mod reg r/m   data   data if s=0	22-25 29-32	22-25 29-32	
<b>DIV</b> = Divide (unsigned):	1111011w   mod110 r/m			
Register-Byte		29	29	
Register-Word		38	38	
Memory-Byte		35	35	
Memory-Word		44	44*	
<b>IDIV</b> = Integer divide (signed):	1111011w   mod111 r/m			
Register-Byte		44-52	44-52	
Register-Word		53-61	53-61	
Memory-Byte		50-58	50-58	
Memory-Word		59-67	59-67*	
<b>AAM</b> = ASCII adjust for multiply	11010100   00001010	19	19	
<b>AAD</b> = ASCII adjust for divide	11010101   00001010	15	15	
<b>CBW</b> = Convert byte to word	10011000	2	2	
<b>CWD</b> = Convert word to double word	10011001	4	4	
<b>LOGIC</b>				
<b>Shift/Rotate Instructions:</b>				
Register/Memory by 1	1101000w   mod TTT r/m	2/15	2/15	
Register/Memory by CL	1101001w   mod TTT r/m	5+n/17+n	5+n/17+n	
Register/Memory by Count	1100000w   mod TTT r/m   count	5+n/17+n	5+n/17+n	
	<b>TTT Instruction</b>			
	000 ROL			
	001 ROR			
	010 RCL			
	011 RCR			
	100 SHL/SAL			
	101 SHR			
	111 SAR			
<b>AND</b> = And:				
Reg/memory and register to either	001000dw   mod reg r/m	3/10	3/10*	
Immediate to register/memory	1000000w   mod100 r/m   data   data if w=1	4/16	4/16*	
Immediate to accumulator	0010010w   data   data if w=1	3/4	3/4*	8/16-bit
<b>TEST = And function to flags, no result:</b>				
Register/memory and register	1000010w   mod reg r/m	3/10	3/10*	
Immediate data and register/memory	1111011w   mod000 r/m   data   data if w=1	4/10	4/10*	
Immediate data and accumulator	1010100w   data   data if w=1	3/4	3/4	8/16-bit
<b>OR</b> = Or:				
Reg/memory and register to either	000010dw   mod reg r/m	3/10	3/10*	
Immediate to register/memory	1000000w   mod001 r/m   data   data if w=1	4/16	4/16*	
Immediate to accumulator	0000110w   data   data if w=1	3/4	3/4*	8/16-bit

1

Shaded areas indicate instructions not available in 8086/8088 microsystems.

**NOTE:**

\*Clock cycles shown for byte transfers. For word operations, add 4 clock cycles for all memory transfers.



**INSTRUCTION SET SUMMARY** (Continued)

Function	Format	80C186EA Clock Cycles	80C188EA Clock Cycles	Comments
<b>LOGIC</b> (Continued)				
<b>XOR = Exclusive or:</b>				
Reg/memory and register to either	001100dw mod reg r/m	3/10	3/10*	
Immediate to register/memory	100000w mod 110 r/m data data if w = 1	4/16	4/16*	
Immediate to accumulator	0011010w data data if w = 1	3/4	3/4	8/16-bit
<b>NOT = Invert register/memory</b>	1111011w mod 010 r/m	3/10	3/10*	
<b>STRING MANIPULATION</b>				
<b>MOVS = Move byte/word</b>	1010010w	14	14*	
<b>CMPS = Compare byte/word</b>	1010011w	22	22*	
<b>SCAS = Scan byte/word</b>	1010111w	15	15*	
<b>LODS = Load byte/wd to AL/AX</b>	1010110w	12	12*	
<b>STOS = Store byte/wd from AL/AX</b>	1010101w	10	10*	
<b>INS = Input byte/wd from DX port</b>	0110110w	14	14	
<b>OUTS = Output byte/wd to DX port</b>	0110111w	14	14	
Repeated by count in CX (REP/REPE/REPZ/REPNE/REPNZ)				
<b>MOVS = Move string</b>	11110010 1010010w	8+8n	8+8n*	
<b>CMPS = Compare string</b>	1111001z 1010011w	5+22n	5+22n	
<b>SCAS = Scan string</b>	1111001z 1010111w	5+15n	5+15n*	
<b>LODS = Load string</b>	11110010 1010110w	6+11n	6+11n*	
<b>STOS = Store string</b>	11110010 1010101w	6+9n	6+9n*	
<b>INS = Input string</b>	11110010 0110110w	8+8n	8+8n*	
<b>OUTS = Output string</b>	11110010 0110111w	8+8n	8+8n*	
<b>CONTROL TRANSFER</b>				
<b>CALL = Call:</b>				
Direct within segment	11101000 disp-low disp-high	15	19	
Register/memory indirect within segment	11111111 mod 010 r/m	13/19	17/27	
Direct intersegment	10011010 segment offset segment selector	23	31	
Indirect intersegment	11111111 mod 011 r/m (mod ≠ 11)	38	54	
<b>JMP = Unconditional jump:</b>				
Short/long	11101011 disp-low	14	14	
Direct within segment	11101001 disp-low disp-high	14	14	
Register/memory indirect within segment	11111111 mod 100 r/m	11/17	11/21	
Direct intersegment	11101010 segment offset segment selector	14	14	
Indirect intersegment	11111111 mod 101 r/m (mod ≠ 11)	26	34	

Shaded areas indicate instructions not available in 8086/8088 microsystems.

**NOTE:**

\*Clock cycles shown for byte transfers. For word operations, add 4 clock cycles for all memory transfers.

**INSTRUCTION SET SUMMARY (Continued)**

Function	Format	80C186EA Clock Cycles	80C188EA Clock Cycles	Comments
<b>CONTROL TRANSFER (Continued)</b>				
<b>RET = Return from CALL:</b>				
Within segment	1 1 0 0 0 0 1 1	16	20	
Within seg adding immed to SP	1 1 0 0 0 0 1 0    data-low    data-high	18	22	
Intersegment	1 1 0 0 1 0 1 1	22	30	
Intersegment adding immediate to SP	1 1 0 0 1 0 1 0    data-low    data-high	25	33	
<b>JE/JZ = Jump on equal/zero</b>	0 1 1 1 0 1 0 0    disp	4/13	4/13	JMP not taken/JMP taken
<b>JL/JNGE = Jump on less/not greater or equal</b>	0 1 1 1 1 1 0 0    disp	4/13	4/13	
<b>JLE/JNG = Jump on less or equal/not greater</b>	0 1 1 1 1 1 1 0    disp	4/13	4/13	
<b>JB/JNAE = Jump on below/not above or equal</b>	0 1 1 1 0 0 1 0    disp	4/13	4/13	
<b>JBE/JNA = Jump on below or equal/not above</b>	0 1 1 1 0 1 1 0    disp	4/13	4/13	
<b>JP/JPE = Jump on parity/parity even</b>	0 1 1 1 1 0 1 0    disp	4/13	4/13	
<b>JO = Jump on overflow</b>	0 1 1 1 0 0 0 0    disp	4/13	4/13	
<b>JS = Jump on sign</b>	0 1 1 1 1 0 0 0    disp	4/13	4/13	
<b>JNE/JNZ = Jump on not equal/not zero</b>	0 1 1 1 0 1 0 1    disp	4/13	4/13	
<b>JNL/JGE = Jump on not less/greater or equal</b>	0 1 1 1 1 1 0 1    disp	4/13	4/13	
<b>JNLE/JG = Jump on not less or equal/greater</b>	0 1 1 1 1 1 1 1    disp	4/13	4/13	
<b>JNB/JAE = Jump on not below/above or equal</b>	0 1 1 1 0 0 1 1    disp	4/13	4/13	
<b>JNBE/JA = Jump on not below or equal/above</b>	0 1 1 1 0 1 1 1    disp	4/13	4/13	
<b>JNP/JPO = Jump on not par/par odd</b>	0 1 1 1 1 0 1 1    disp	4/13	4/13	
<b>JNO = Jump on not overflow</b>	0 1 1 1 0 0 0 1    disp	4/13	4/13	
<b>JNS = Jump on not sign</b>	0 1 1 1 1 0 0 1    disp	4/13	4/13	
<b>JCXZ = Jump on CX zero</b>	1 1 1 0 0 0 1 1    disp	5/15	5/15	
<b>LOOP = Loop CX times</b>	1 1 1 0 0 0 1 0    disp	6/16	6/16	LOOP not taken/LOOP taken
<b>LOOPZ/LOOPE = Loop while zero/equal</b>	1 1 1 0 0 0 0 1    disp	6/16	6/16	
<b>LOOPNZ/LOOPNE = Loop while not zero/equal</b>	1 1 1 0 0 0 0 0    disp	6/16	6/16	
<b>ENTER = Enter Procedure</b>	1 1 0 0 1 0 0 0    data-low    data-high    L	15 25 22 + 16(n - 1)	19 29 20 + 20(n - 1)	
<b>LEAVE = Leave Procedure</b>	1 1 0 0 1 0 0 1	8	8	
<b>INT = Interrupt:</b>				
Type specified	1 1 0 0 1 1 0 1    type	47	47	
Type 3	1 1 0 0 1 1 0 0	45	45	if INT. taken/ if INT. not taken
<b>INTO = Interrupt on overflow</b>	1 1 0 0 1 1 1 0	48/4	48/4	
<b>IRET = Interrupt return</b>	1 1 0 0 1 1 1 1	28	28	
<b>BOUND = Detect value out of range</b>	0 1 1 0 0 0 1 0    mod/reg r/m	33-35	33-35	

Shaded areas indicate instructions not available in 8086/8088 microsystems.

**NOTE:**

\*Clock cycles shown for byte transfers. For word operations, add 4 clock cycles for all memory transfers.





**INSTRUCTION SET SUMMARY** (Continued)

Function	Format	80C186EA Clock Cycles	80C188EA Clock Cycles	Comments
<b>PROCESSOR CONTROL</b>				
<b>CLC</b> = Clear carry	11111000	2	2	
<b>CMC</b> = Complement carry	11110101	2	2	
<b>STC</b> = Set carry	11111001	2	2	
<b>CLD</b> = Clear direction	11111100	2	2	
<b>STD</b> = Set direction	11111101	2	2	
<b>CLI</b> = Clear interrupt	11111010	2	2	
<b>STI</b> = Set interrupt	11111011	2	2	
<b>HLT</b> = Halt	11110100	2	2	
<b>WAIT</b> = Wait	10011011	6	6	if TEST = 0
<b>LOCK</b> = Bus lock prefix	11110000	2	2	
<b>NOP</b> = No Operation	10010000	3	3	
(TTT LLL are opcode to processor extension)				

Shaded areas indicate instructions not available in 8086/8088 microsystems.

**NOTE:**

\*Clock cycles shown for byte transfers. For word operations, add 4 clock cycles for all memory transfers.

The Effective Address (EA) of the memory operand is computed according to the mod and r/m fields:

- if mod = 11 then r/m is treated as a REG field
- if mod = 00 then DISP = 0\*, disp-low and disp-high are absent
- if mod = 01 then DISP = disp-low sign-extended to 16-bits, disp-high is absent
- if mod = 10 then DISP = disp-high; disp-low
- if r/m = 000 then EA = (BX) + (SI) + DISP
- if r/m = 001 then EA = (BX) + (DI) + DISP
- if r/m = 010 then EA = (BP) + (SI) + DISP
- if r/m = 011 then EA = (BP) + (DI) + DISP
- if r/m = 100 then EA = (SI) + DISP
- if r/m = 101 then EA = (DI) + DISP
- if r/m = 110 then EA = (BP) + DISP\*
- if r/m = 111 then EA = (BX) + DISP

DISP follows 2nd byte of instruction (before data if required)

\*except if mod = 00 and r/m = 110 then EA = disp-high; disp-low.

EA calculation time is 4 clock cycles for all modes, and is included in the execution times given whenever appropriate.

**Segment Override Prefix**

0	0	1	reg	1	1	0
---	---	---	-----	---	---	---

reg is assigned according to the following:

reg	Segment Register
00	ES
01	CS
10	SS
11	DS

REG is assigned according to the following table:

16-Bit (w = 1)	8-Bit (w = 0)
000 AX	000 AL
001 CX	001 CL
010 DX	010 DL
011 BX	011 BL
100 SP	100 AH
101 BP	101 CH
110 SI	110 DH
111 DI	111 BH

The physical addresses of all operands addressed by the BP register are computed using the SS segment register. The physical addresses of the destination operands of the string primitive operations (those addressed by the DI register) are computed using the ES segment, which may not be overridden.



## REVISION HISTORY

Intel 80C186EA/80L186EA devices are marked with a 9-character alphanumeric Intel FPO number underneath the product number. This data sheet update is valid for devices with an "A", "B", "C", "D", or "E" as the ninth character in the FPO number, as illustrated in Figure 5 for the 68-lead PLCC package, Figure 6 for the 84-lead QFP (EIAJ) package, and Figure 7 for the 80-lead SQFP device. Such devices may also be identified by reading a value of 01H, 02H, 03H from the STEPID register.

This data sheet replaces the following data sheets:

- 272019-002—80C186EA
- 272020-002—80C188EA
- 272021-002—80L186EA
- 272022-002—80L188EA
- 272307-001—SB80C186EA/SB80L186EA
- 272308-001—SB80C188EA/SB80L188EA

## ERRATA

An 80C186EA/80L186EA with a STEPID value of 01H or 02H has the following known errata. A device with a STEPID of 01H or 02H can be visually identified by noting the presence of an "A", "B", or "C" alpha character, next to the FPO number. The FPO number location is shown in Figures 5, 6, and 7.

1. An internal condition with the interrupt controller can cause no acknowledge cycle on the INTA1 line in response to INT1. This errata only occurs when Interrupt 1 is configured in cascade mode and a higher priority interrupt exists. This errata will not occur consistently, it is dependent on interrupt timing.

An 80C186EA/80L186EA with a STEPID value of 03H has no known errata. A device with a STEPID of 03H can be visually identified by noting the presence of a "D" or "E" alpha character next to the FPO number. The FPO number location is shown in Figures 5, 6, and 7.

1