

Contents

Features	1
Block Diagram	1
Applications	1
Selection Guide	1
Pin Assignment	2
Advantages over the S-812 Series	2
Absolute Maximum Ratings	2
Electrical Characteristics	3
Test Circuits	7
Technical Terms	8
Operation	8
Transient Response	10
Dimensions	20
Markings	20
Taping	21
Magazine Dimensions	22
Standard Circuit	23
Application Circuits	23
Notes on Design	24
Characteristics	25
Measuring Circuits.....	30

The S-813 Series is a three-terminal positive voltage regulator made using a CMOS process. The output voltage is fixed internally. The S-813 Series has higher accuracy of output voltage ($\pm 2.4\%$) and needs a smaller input/output voltage difference ($V_{dif} = 0.12\text{ V}$ when I_{OUT} is 40 mA) than the S-812 Series, so battery-powered portable equipment can have a higher capacity and a longer service life.

■ Features

- Low current consumption: 16 μA typ.
- Small input/output voltage difference (Ex: S-81350HG: 0.12 V typ. $I_{OUT} = 40\text{ mA}$)
- High accuracy of output voltage: $\pm 2.4\%$
- Wide operating voltage range: 15 V max.
- Wide operating temperature range: -30°C to 80°C
- TO-92 or SOT-89-3 plastic package

■ Block Diagram

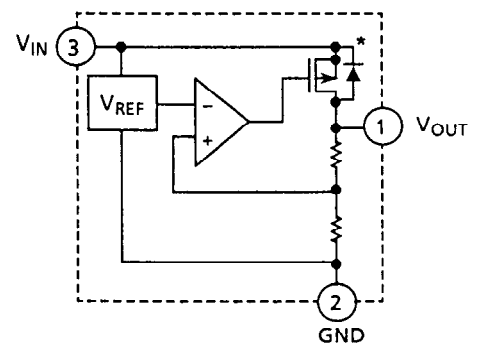

* Parasitic diode

Figure 1

■ Applications

- Constant voltage power supply of VTR, camera, OA equipment, cordless phone, and others

■ Selection Guide

Table 1

Output voltage	TO-92	SOT-89-3*
2.2 V $\pm 2.4\%$	—	S-81322HG-KW-X
3.0 V $\pm 2.4\%$	S-81330HG	S-81330HG-KB-X
3.2 V $\pm 2.4\%$	S-81332HG	S-81332HG-KC-X
3.3 V $\pm 2.4\%$	—	S-81333HG-KF-X
3.5 V $\pm 2.4\%$	—	S-81335HG-KI-X
3.7 V $\pm 2.4\%$	—	S-81337HG-KE-X
4.0 V $\pm 2.4\%$	—	S-81340HG-KJ-X
4.7 V $\pm 2.4\%$	—	S-81347HG-KQ-X
5.0 V $\pm 2.4\%$	S-81350HG	S-81350HG-KD-X

* The last digit of the model name changes depending upon the packing form when it is an SOT-89-3 package product.

X = S : Stick

X = T1 or T2 : Tape

** Please ask our sales person if you need another output voltage product.

HIGH-PRECISION VOLTAGE REGULATOR

S-813 Series

Pin Assignment

www.DataSheet4U.com

1. TO-92

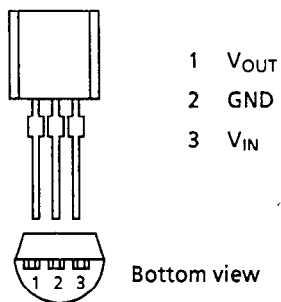

Figure 2

2. SOT-89-3

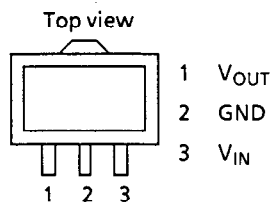

Figure 3

Advantages over the S-812 Series

The S-813 Series has the following advantages over conventional voltage regulators such as the S-812 Series.

1. Small input/output voltage difference

Input/output voltage difference against output current is much smaller. For example in the S-81350HG, it is only 0.12 V when output current is 40 mA. In battery-powered equipment, the S-813 Series prolongs the battery service life.

2. Large output current available

Output current is allowed up to 100 mA. In this case, however, be careful with input voltage and power dissipation.

Absolute Maximum Ratings

Table 2

(Unless otherwise specified: $T_a = 25^\circ\text{C}$)

Parameter	Symbol	Ratings	Unit
Input voltage	V_{IN}	18	V
Output voltage	V_{OUT}	$V_{IN} + 0.3$ to $V_{SS} - 0.3$	V
Power dissipation	P_D	500	mW
Operating temperature	T_{opr}	-30 to +80	$^\circ\text{C}$
Storage temperature	T_{stg}	-40 to +125	$^\circ\text{C}$

Caution : Keep static electricity to a minimum.

■ **Electrical Characteristics**

www.DataSheet4U.com

1. S-81322HG-KW-X

Table 3

(Unless otherwise specified: Ta = 25°C)

Parameter	Symbol	Conditions	Min.	Typ.	Max.	Unit	Test cir.
Output voltage	V _{OUT}	V _{IN} = 4.2 V, I _{OUT} = 30 mA	2.147	2.200	2.253	V	1
Input/output voltage difference	V _{dif}	I _{OUT} = 30 mA	—	0.22	0.44	V	1
Load regulation	ΔV _{OUT}	I _{OUT} = 10 μA to 30 mA V _{IN} = 4.2 V	—	60	150	mV	1
Current consumption	I _{SS}	V _{IN} = 4.2 V, No loaded	—	16	30	μA	2
Line regulation	$\frac{\Delta V_{OUT}}{\Delta V_{IN} \cdot V_{OUT}}$	V _{IN} = 3.2V to 14 V I _{OUT} = 30 mA	—	0.04	0.2	% / V	1
Input voltage	V _{IN}		—	—	15	V	—
Temperature characteristic of ΔV _{OUT}	$\frac{\Delta V_{OUT}}{\Delta T_a}$	I _{OUT} = 30 mA, V _{IN} = 4.2 V Ta = -30°C to 80°C	—	± 0.26	—	mV/°C	—
Ripple rejection	RR	f = 100 Hz, CL = 100 μF I _{OUT} = 30 mA, V _{IN} = 4.2 V	—	35	—	dB	—

* Definition of input/output voltage difference : V_{IN2}-V_{OUT1}
V_{OUT1} = Output voltage when input voltage is 4.2 V
V_{IN2} = Input voltage when 98% of V_{OUT1} is output.

2. S-81330HG, S-81330HG-KB-X

Table 4

(Unless otherwise specified: Ta = 25°C)

Parameter	Symbol	Conditions	Min.	Typ.	Max.	Unit	Test cir.
Output voltage	V _{OUT}	V _{IN} = 5 V, I _{OUT} = 30 mA	2.928	3.000	3.072	V	1
Input/output voltage difference	V _{dif}	I _{OUT} = 30 mA	—	0.14	0.28	V	1
Load regulation	ΔV _{OUT}	I _{OUT} = 10 μA to 30 mA V _{IN} = 5 V	—	60	150	mV	1
Current consumption	I _{SS}	V _{IN} = 5 V, No loaded	—	16	30	μA	2
Line regulation	$\frac{\Delta V_{OUT}}{\Delta V_{IN} \cdot V_{OUT}}$	V _{IN} = 4 to 15 V I _{OUT} = 30 mA	—	0.04	0.2	%/V	1
Input voltage	V _{IN}		—	—	15	V	—
Temperature characteristic of ΔV _{OUT}	$\frac{\Delta V_{OUT}}{\Delta T_a}$	I _{OUT} = 30 mA, V _{IN} = 5 V Ta = -30°C to 80°C	—	± 0.35	—	mV/°C	—
Ripple rejection	RR	f = 100 Hz, CL = 100 μF I _{OUT} = 30 mA, V _{IN} = 5 V	—	48	—	dB	—

* Definition of input/output voltage difference : V_{IN2}-V_{OUT1}
V_{OUT1} = Output voltage when input voltage is 5 V
V_{IN2} = Input voltage when 98% of V_{OUT1} is output.

HIGH-PRECISION VOLTAGE REGULATOR

S-813 Series

3. S-81332HG, S-81332HG-KC-X

Table 5

(Unless otherwise specified: Ta = 25°C)

Parameter	Symbol	Conditions	Min.	Typ.	Max.	Unit	Test cir.
Output voltage	V _{OUT}	V _{IN} = 5.2 V, I _{OUT} = 30 mA	3.123	3.200	3.277	V	1
Input/output voltage difference	V _{dif}	I _{OUT} = 30 mA	—	0.14	0.28	V	1
Load regulation	ΔV _{OUT}	I _{OUT} = 10 μA to 30 mA V _{IN} = 5.2 V	—	60	150	mV	1
Current consumption	I _{SS}	V _{IN} = 5.2 V, No loaded	—	16	30	μA	2
Line regulation	$\frac{\Delta V_{OUT}}{\Delta V_{IN} \cdot V_{OUT}}$	V _{IN} = 4 to 15 V I _{OUT} = 30 mA	—	0.04	0.2	%/V	1
Input voltage	V _{IN}		—	—	15	V	—
Temperature characteristic of ΔV _{OUT}	$\frac{\Delta V_{OUT}}{\Delta T_a}$	I _{OUT} = 30 mA, V _{IN} = 5.2 V Ta = -30°C to 80°C	—	± 0.40	—	mV/°C	—
Ripple rejection	RR	f = 100 Hz, CL = 100 μF I _{OUT} = 30 mA, V _{IN} = 5.2 V	—	48	—	dB	—

* Definition of input/output voltage difference : V_{IN2}-V_{OUT1}
V_{OUT1} = Output voltage when input voltage is 5.2 V
V_{IN2} = Input voltage when 98% of V_{OUT1} is output.

4. S-81333HG-KF-X

Table 6

(Unless otherwise specified: Ta = 25°C)

Parameter	Symbol	Conditions	Min.	Typ.	Max.	Unit	Test cir.
Output voltage	V _{OUT}	V _{IN} = 5.3 V, I _{OUT} = 30 mA	3.221	3.300	3.379	V	1
Input/output voltage difference	V _{dif}	I _{OUT} = 30 mA	—	0.14	0.28	V	1
Load regulation	ΔV _{OUT}	I _{OUT} = 10 μA to 30 mA V _{IN} = 5.3 V	—	60	150	mV	1
Current consumption	I _{SS}	V _{IN} = 5.3 V, No loaded	—	16	30	μA	2
Line regulation	$\frac{\Delta V_{OUT}}{\Delta V_{IN} \cdot V_{OUT}}$	V _{IN} = 4.3 V to 15 V I _{OUT} = 30 mA	—	0.04	0.2	% / V	1
Input voltage	V _{IN}		—	—	15	V	—
Temperature characteristic of ΔV _{OUT}	$\frac{\Delta V_{OUT}}{\Delta T_a}$	I _{OUT} = 30 mA, V _{IN} = 5.3 V Ta = -30°C to 80°C	—	± 0.40	—	mV/°C	—
Ripple rejection	RR	f = 100 Hz, CL = 100 μF I _{OUT} = 30 mA, V _{IN} = 5.3 V	—	48	—	dB	—

* Definition of input/output voltage difference : V_{IN2}-V_{OUT1}
V_{OUT1} = Output voltage when input voltage is 5.3 V
V_{IN2} = Input voltage when 98% of V_{OUT1} is output.

5. S-81335HG-KI-X
www.DataSheet4U.com

Table 7

(Unless otherwise specified: Ta = 25°C)

Parameter	Symbol	Conditions	Min.	Typ.	Max.	Unit	Test cir.
Output voltage	V _{OUT}	V _{IN} = 5.5 V, I _{OUT} = 30 mA	3.416	3.500	3.584	V	1
Input/output voltage difference	V _{dif}	I _{OUT} = 30 mA	—	0.14	0.28	V	1
Load regulation	ΔV _{OUT}	I _{OUT} = 10 μA to 30 mA V _{IN} = 5.5 V	—	60	150	mV	1
Current consumption	I _{SS}	V _{IN} = 5.5 V, No loaded	—	16	30	μA	2
Line regulation	$\frac{\Delta V_{OUT}}{\Delta V_{IN} - V_{OUT}}$	V _{IN} = 4.5 V to 15 V I _{OUT} = 30 mA	—	0.04	0.2	% / V	1
Input voltage	V _{IN}		—	—	15	V	—
Temperature characteristic of ΔV _{OUT}	$\frac{\Delta V_{OUT}}{\Delta Ta}$	I _{OUT} = 30 mA, V _{IN} = 5.5 V Ta = -30°C to 80°C	—	± 0.41	—	mV/°C	—
Ripple rejection	RR	f = 100 Hz, CL = 100 μF I _{OUT} = 30 mA, V _{IN} = 5.5 V	—	48	—	dB	—

* Definition of input/output voltage difference : V_{IN2}-V_{OUT1}
V_{OUT1} = Output voltage when input voltage is 5.5 V
V_{IN2} = Input voltage when 98% of V_{OUT1} is output.

6. S-81337HG-KE-X

Table 8

(Unless otherwise specified: Ta = 25°C)

Parameter	Symbol	Conditions	Min.	Typ.	Max.	Unit	Test cir.
Output voltage	V _{OUT}	V _{IN} = 5.7 V, I _{OUT} = 30 mA	3.611	3.700	3.789	V	1
Input/output voltage difference	V _{dif}	I _{OUT} = 30 mA	—	0.14	0.28	V	1
Load regulation	ΔV _{OUT}	I _{OUT} = 10 μA to 30 mA V _{IN} = 5.7 V	—	60	150	mV	1
Current consumption	I _{SS}	V _{IN} = 5.7 V, No loaded	—	16	30	μA	2
Line regulation	$\frac{\Delta V_{OUT}}{\Delta V_{IN} - V_{OUT}}$	V _{IN} = 4.7 to 15 V I _{OUT} = 30 mA	—	0.04	0.2	% / V	1
Input voltage	V _{IN}		—	—	15	V	—
Temperature characteristic of ΔV _{OUT}	$\frac{\Delta V_{OUT}}{\Delta Ta}$	I _{OUT} = 30 mA, V _{IN} = 5.7 V Ta = -30°C to 80°C	—	± 0.43	—	mV/°C	—
Ripple rejection	RR	f = 100 Hz, CL = 100 μF I _{OUT} = 30 mA, V _{IN} = 5.7 V	—	48	—	dB	—

* Definition of input/output voltage difference : V_{IN2}-V_{OUT1}
V_{OUT1} = Output voltage when input voltage is 5.7 V
V_{IN2} = Input voltage when 98% of V_{OUT1} is output.

HIGH-PRECISION VOLTAGE REGULATOR

S-813 Series

7. S-81340HG-KJ-X
www.DataSheet4U.com

Table 9

(Unless otherwise specified: Ta = 25°C)

Parameter	Symbol	Conditions	Min.	Typ.	Max.	Unit	Test cir.
Output voltage	V _{OUT}	V _{IN} = 6.0 V, I _{OUT} = 40 mA	3.904	4.000	4.096	V	1
Input/output voltage difference	V _{dif}	I _{OUT} = 40 mA	—	0.12	0.24	V	1
Load regulation	ΔV _{OUT}	I _{OUT} = 50 μA to 60 mA V _{IN} = 6.0 V	—	70	110	mV	1
Current consumption	I _{SS}	V _{IN} = 6.0 V, No loaded	—	16	30	μA	2
Line regulation	$\frac{\Delta V_{OUT}}{\Delta V_{IN} \cdot V_{OUT}}$	V _{IN} = 5 to 15 V I _{OUT} = 40 mA	—	0.04	0.2	%/V	1
Input voltage	V _{IN}		—	—	15	V	—
Temperature characteristic of ΔV _{OUT}	$\frac{\Delta V_{OUT}}{\Delta T_a}$	I _{OUT} = 40 mA, V _{IN} = 6.0 V Ta = -30°C to 80°C	—	± 0.46	—	mV/°C	—
Ripple rejection	RR	f = 100 Hz, CL = 100 μF I _{OUT} = 40 mA, V _{IN} = 6.0 V	—	45	—	dB	—

* Definition of input/output voltage difference : V_{IN2}-V_{OUT1}
V_{OUT1} = Output voltage when input voltage is 6.0 V
V_{IN2} = Input voltage when 98% of V_{OUT1} is output.

8. S-81347HG-KQ-X

Table 10

(Unless otherwise specified: Ta = 25°C)

Parameter	Symbol	Conditions	Min.	Typ.	Max.	Unit	Test cir.
Output voltage	V _{OUT}	V _{IN} = 6.7 V, I _{OUT} = 40 mA	4.587	4.700	4.813	V	1
Input/output voltage difference	V _{dif}	I _{OUT} = 40 mA	—	0.12	0.24	V	1
Load regulation	ΔV _{OUT}	I _{OUT} = 50 μA to 60 mA V _{IN} = 6.7 V	—	70	110	mV	1
Current consumption	I _{SS}	V _{IN} = 6.7 V, No loaded	—	16	30	μA	2
Line regulation	$\frac{\Delta V_{OUT}}{\Delta V_{IN} \cdot V_{OUT}}$	V _{IN} = 5.7 to 15 V I _{OUT} = 40 mA	—	0.04	0.2	%/V	1
Input voltage	V _{IN}		—	—	15	V	—
Temperature characteristic of ΔV _{OUT}	$\frac{\Delta V_{OUT}}{\Delta T_a}$	I _{OUT} = 40 mA, V _{IN} = 6.7 V Ta = -30°C to 80°C	—	± 0.53	—	mV/°C	—
Ripple rejection	RR	f = 100 Hz, CL = 100 μF I _{OUT} = 40 mA, V _{IN} = 6.7 V	—	45	—	dB	—

* Definition of input/output voltage difference : V_{IN2}-V_{OUT1}
V_{OUT1} = Output voltage when input voltage is 6.7 V
V_{IN2} = Input voltage when 98% of V_{OUT1} is output.

- 9. S-81350HG, S-81350HG-KD-X
www.DataSheet4U.com

Table 11

(Unless otherwise specified: $T_a = 25^\circ\text{C}$)

Parameter	Symbol	Conditions	Min.	Typ.	Max.	Unit	Test cir.
Output voltage	V_{OUT}	$V_{IN} = 7\text{ V}$, $I_{OUT} = 40\text{ mA}$	4.88	5.00	5.12	V	1
Input/output voltage difference	V_{dif}	$I_{OUT} = 40\text{ mA}$	—	0.12	0.24	V	1
Load regulation	ΔV_{OUT}	$I_{OUT} = 50\ \mu\text{A}$ to 60 mA $V_{IN} = 7\text{ V}$	—	70	110	mV	1
Current consumption	I_{SS}	$V_{IN} = 7\text{ V}$, No loaded	—	16	30	μA	2
Line regulation	$\frac{\Delta V_{OUT}}{\Delta V_{IN}} \cdot V_{OUT}$	$V_{IN} = 6$ to 15 V $I_{OUT} = 40\text{ mA}$	—	0.04	0.2	%/V	1
Input voltage	V_{IN}		—	—	15	V	—
Temperature characteristic of ΔV_{OUT}	$\frac{\Delta V_{OUT}}{\Delta T_a}$	$I_{OUT} = 40\text{ mA}$, $V_{IN} = 7\text{ V}$ $T_a = -30^\circ\text{C}$ to 80°C	—	± 0.53	—	mV/ $^\circ\text{C}$	—
Ripple rejection	RR	$f = 100\text{ Hz}$, $C_L = 100\ \mu\text{F}$ $I_{OUT} = 40\text{ mA}$, $V_{IN} = 7\text{ V}$	—	45	—	dB	—

* Definition of input/output voltage difference : $V_{IN2} - V_{OUT1}$
 V_{OUT1} = Output voltage when input voltage is 7 V
 V_{IN2} = Input voltage when 98% of V_{OUT1} is output.

■ Test Circuits

1.

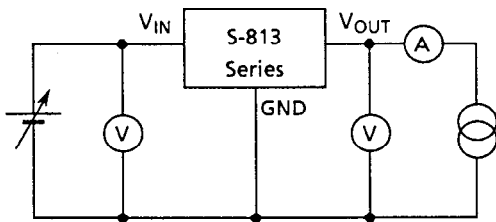

2.

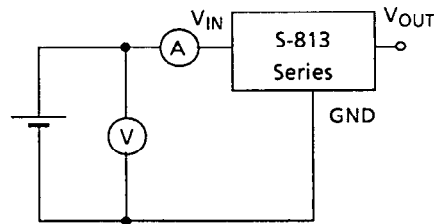

Figure 4

HIGH-PRECISION VOLTAGE REGULATOR

S-813 Series

■ Technical Terms

1. Output voltage (V_{OUT})

Output voltage V_{OUT} is that voltage guaranteed by the voltage regulator (accuracy $\pm 2.4\%$) under given input voltage, output current, and temperature conditions. Changes in these conditions will result in an output voltage that may exceed specification limits. For details, please refer to electrical characteristics and characteristics data.

2. Line regulation ($\Delta V_{OUT}/\Delta V_{IN} \times V_{OUT}$)

This value represents the degree of dependence of the output voltage on the input voltage. It shows the change in output voltage for a given change in input voltage, with output current fixed.

3. Load regulation (ΔV_{OUT})

This value represents the degree of dependence of the output voltage on the output current. It quantifies the change in output voltage for a given change in output current, with input voltage fixed.

4. Input/output voltage difference (V_{dif})

Inputting a product's output voltage (V_{OUT}) + input/output voltage difference (V_{dif}) to V_{IN} causes output of $V_{OUT} \times 98\%$. A low V_{dif} value suggests that a regulator is (1) capable of delivering constant output voltages even with marginal (low) input voltages, and (2) capable of outputting substantial current. For these reasons, a low V_{dif} value is desirable.

Note : V_{dif} is highly dependent on I_{OUT} .

■ Operation

1 Basic operation

Figure 5 shows the block diagram of the S-813 Series. The error amplifier compares a reference voltage V_{REF} with a part of the output voltage fed back by the feedback resistor R_A and R_B . It supplies the control transistor with the base current, necessary to keep a stable output voltage range not influenced by input voltage or temperature fluctuation.

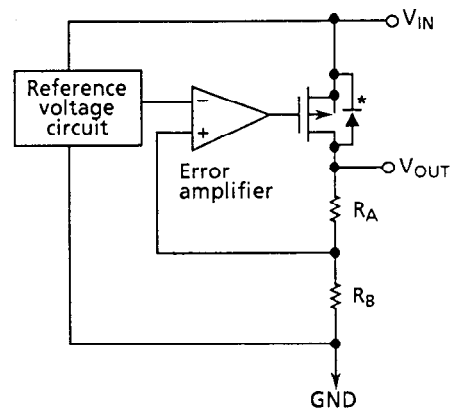

* Parasitic diode

Figure 5 Reference block diagram

2 Internal Circuit

2.1 Reference voltage circuit

In a voltage regulator, the reference voltage circuit plays a very important role because any abnormality will show up directly at an output. The S-813 Series uses a 0.7-V typical reference voltage circuit as a high-stable reference voltage source.

It features:

- Low power consumption
- Good temperature characteristic

2.2 Error amplifier

The error amplifier consumes 0.5 μA of current because it is a differential amplifier in a stable current circuit.

It features:

- Good matching characteristics
- Wide operating voltage range
- Low offset voltage

2.3 Control transistor

The S-813 Series has a Pch MOS transistor as a current control transistor shown in Figure 7. Therefore an output current I_{OUT} is expressed by the following formula where an input/output voltages difference is small.

$$I_{OUT} = KP \{ 2(V_{GS} - V_{TP}) (V_{IN} - V_{OUT}) - (V_{IN} - V_{OUT})^2 \}$$

* KP : Conductive coefficient

V_{TP}: Threshold voltage of a control transistor

Setting KP to the large value results in a voltage regulator with 120 mV typical (in case of the S-81350HG) of input/output voltage difference.

Note

For an application with a current consumption of less than 10 μA (S-81330HG, S-81332HG, S-81337HG) or 50 μA (S-81340HG, S-81347HG, S-81350HG), the leakage current of the control transistor increases with the output voltage.

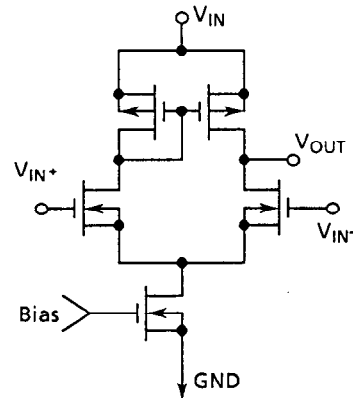
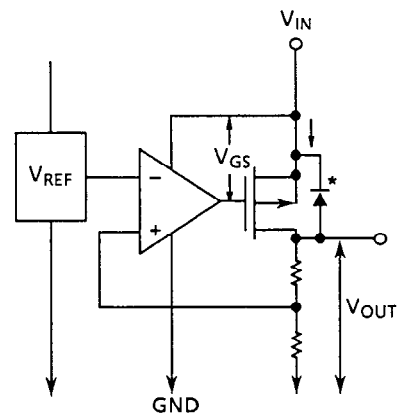

Figure 6 Error amplifier



* Parasitic diode

Figure 7 Control transistor

■ **Transient Response**

If input voltage or load current of S-813 Series fluctuates transiently, large overshoot or undershoot is caused in the output voltage. If an undershoot is very large in case a voltage detector is used in the load circuit, the voltage detector may detect a mistaken value. If an overshoot is very large, the load circuit is bad-influenced. Therefore, it is important to determine the capacitor value so that both undershoot and overshoot are reduced as much as possible.

1. Line transient response due to input voltage fluctuation

Line transient response of output voltage differs with the types of input voltage fluctuation: type I (square wave between 4 V and 8 V for S-81330HG, and between 6V to 10V for S-81350HG) and type II (square wave from 0 V to 10 V) (see Figure 8). This section describes the ringing waveforms and parameter dependency of each type. For reference, Figure 9 describes the measurement circuit.

Type I : Square wave between 4V and 8V, or 6V to 10V

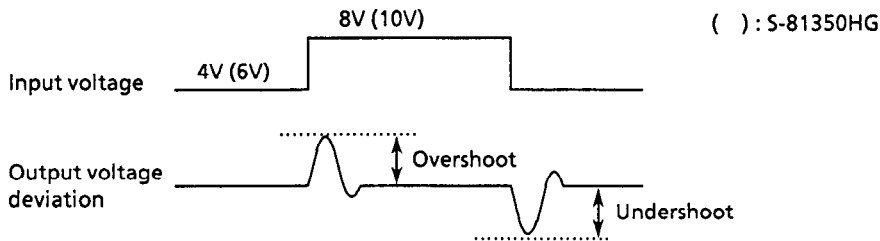

Type II : Square wave from 0V to 10V

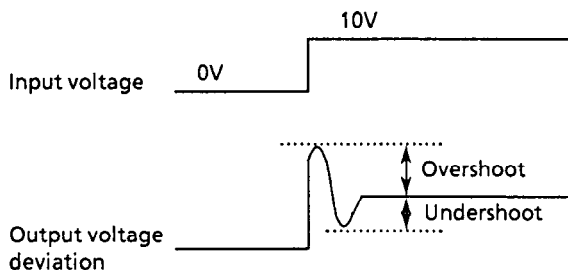

Figure 8

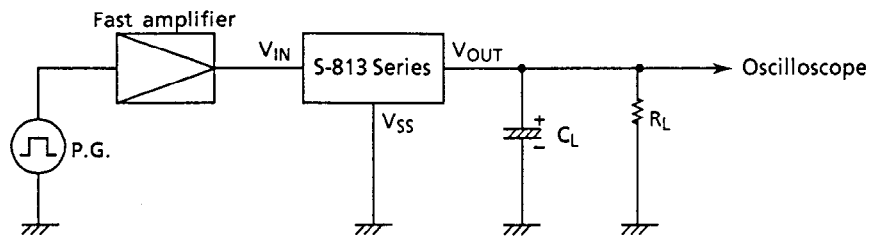

Figure 9 Measuring circuit

Type I Parameter dependency when V_{IN} is between 4V and 8V.

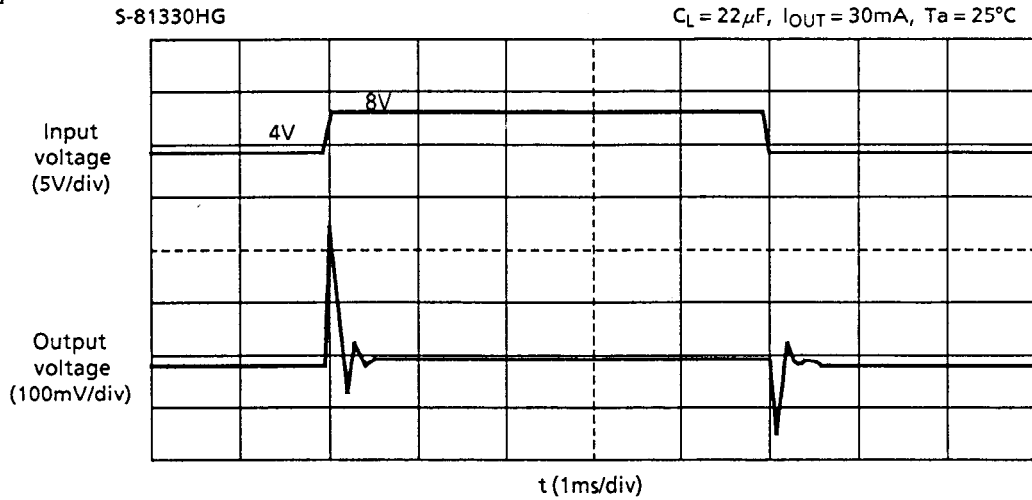

Figure 10 Type I ringing waveform

Table 12 Type I parameter dependency

Parameter	Conditions	Method to decrease overshoot	Method to decrease undershoot
Output current I_{OUT}	5 to 80 mA	Decrease	Decrease
Load capacitance C_L	1 to 47 μF	Increase	Increase
Input voltage fluctuation ΔV_{IN}^*	1 to 4 V	Decrease	Decrease
Temperature T_a	-30°C to +80°C	High temperature	High temperature

* V_{IN} : High voltage value – low voltage value

Type II Parameter dependency

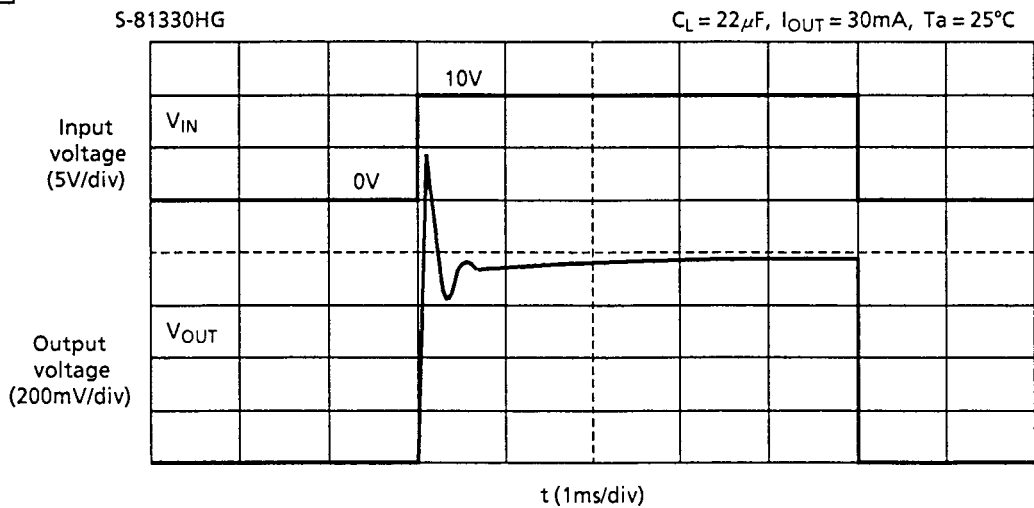

Figure 11 Type II ringing waveform

Table 13 Type II parameter dependency

Parameter	Conditions	Method to decrease overshoot	Method to decrease undershoot
Output current I_{OUT}	5 to 80 mA	Increase	Decrease
Load capacitance C_L	1 to 47 μF	Increase	Increase
Temperature T_a	-30°C to +80°C	High temperature	High temperature

* V_{IN} : High voltage value – low voltage value

For reference, the following pages describe the results of measuring the ringing amounts at the V_{OUT} pin using the output current (I_{OUT}), output capacitance (C_L), input voltage (V_{IN}), and temperature (T_a) as parameters.

HIGH-PRECISION VOLTAGE REGULATOR

S-813 Series

Reference data : Type I

1. I_{OUT} dependency

1.1 Overshoot

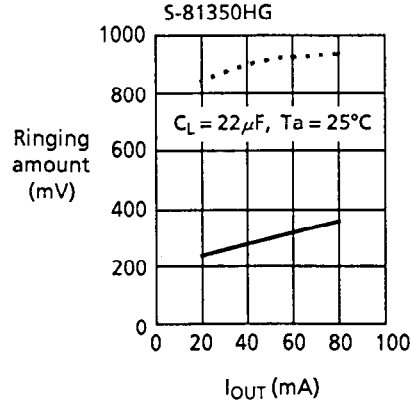
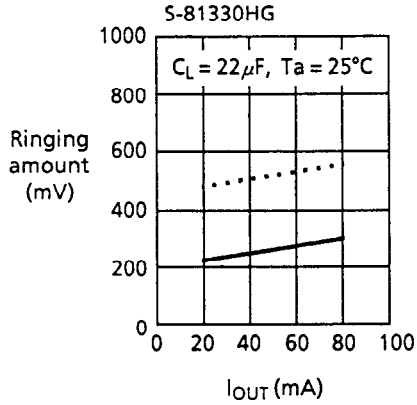

1.2 Undershoot

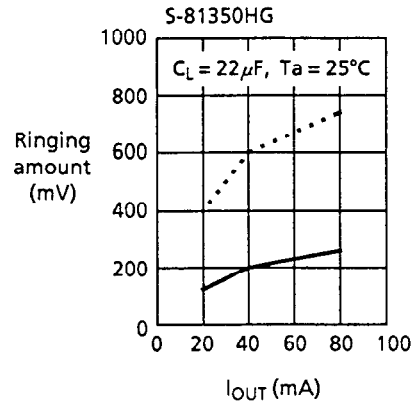
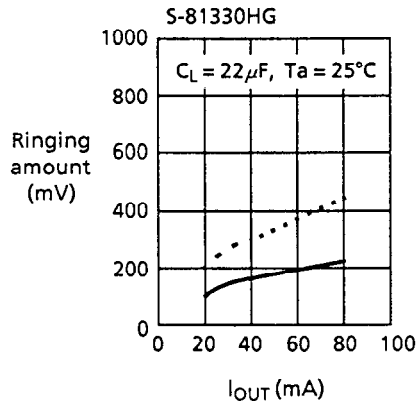

2. C_L dependency

2.1 Overshoot

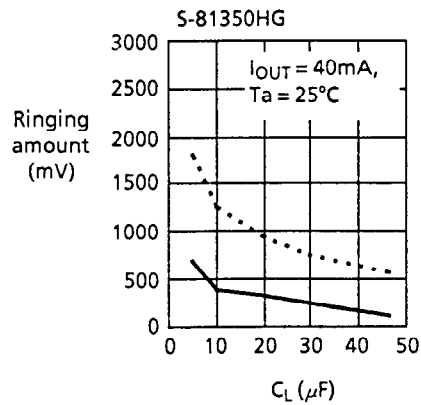
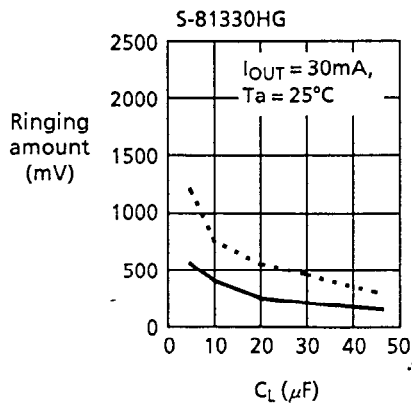

— Typical
... Worst

2.2 Undershoot
www.DataSheet4U.com

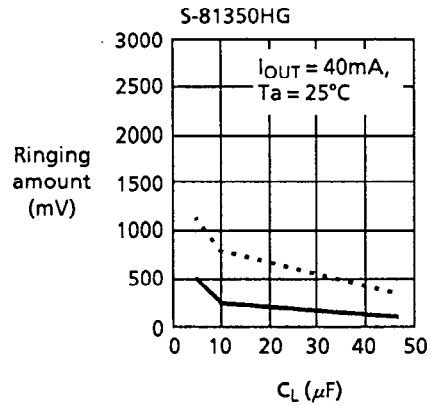
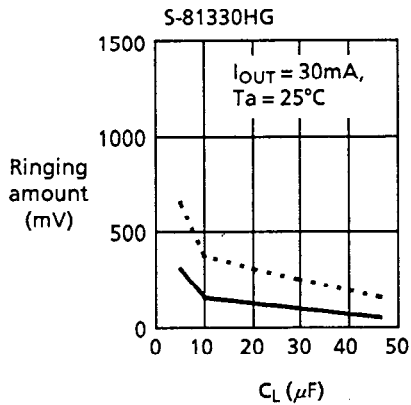

3. VIN dependency

3.1 Overshoot

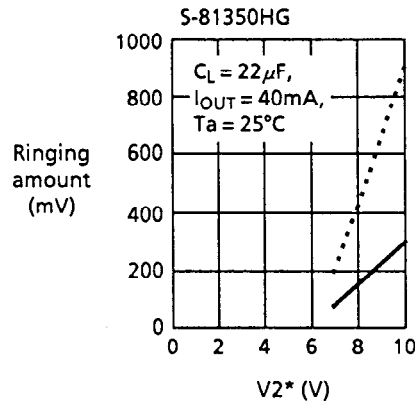
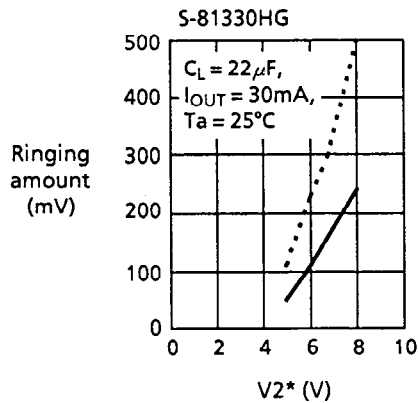

* V_2 represents the higher value of input voltage fluctuation. The lower value is fixed to 4V for S-81330HG, and to 6V for S-81350HG.

Example : when $V_2 = 6V$ in S-81330HG, input voltage fluctuation is between 4V and 6V.

3.2 Undershoot

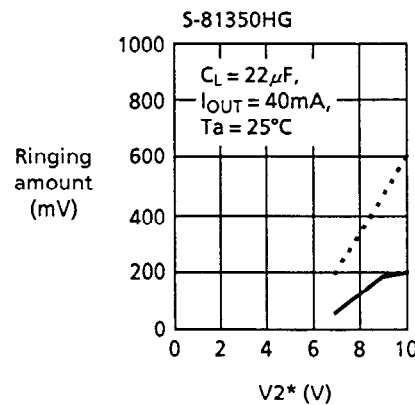
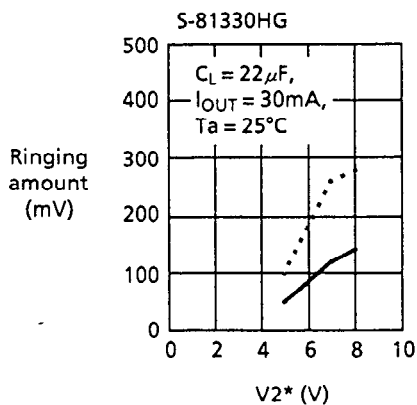

— Typical
 Worst

* V_2 represents the higher value of input voltage fluctuation. The lower value is fixed to 4V for S-81330HG, and to 6V for S-81350HG.

Example : when $V_2 = 6V$ in S-81330HG, input voltage fluctuation is between 4V and 6V.

HIGH-PRECISION VOLTAGE REGULATOR S-813 Series

4. Temperature dependency

www.DataSheet4U.com

4.1 Overshoot

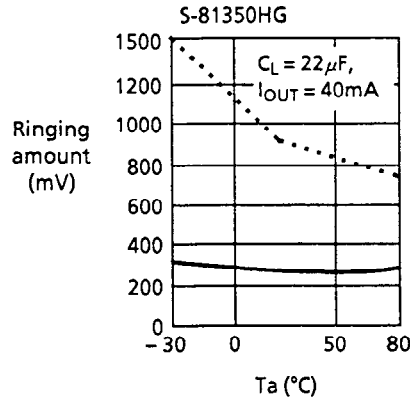
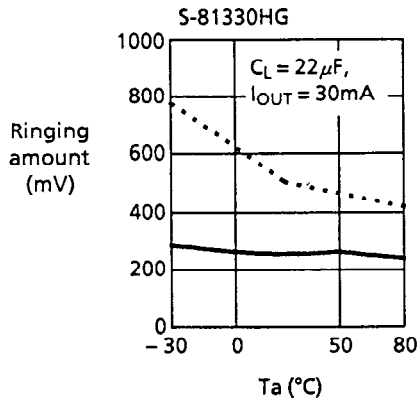

4.2 Undershoot

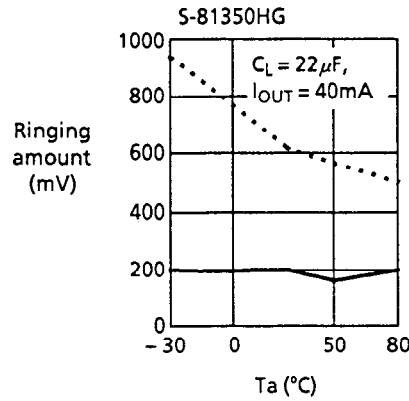
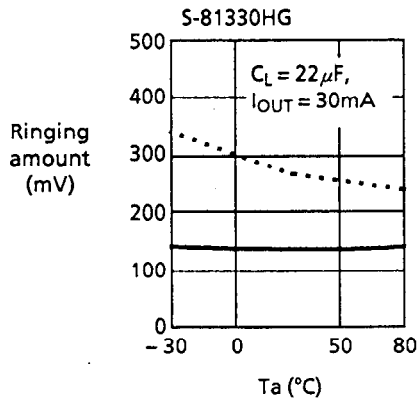

Reference data : Type II

1. I_{OUT} dependency

1.1 Overshoot

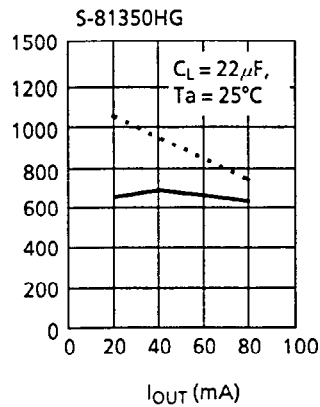
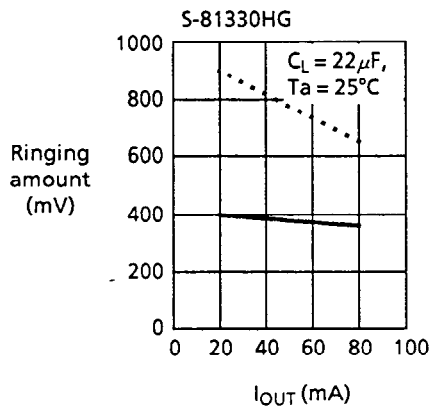

— Typical
... Worst

1.2 Undershoot

www.DataSheet4U.com

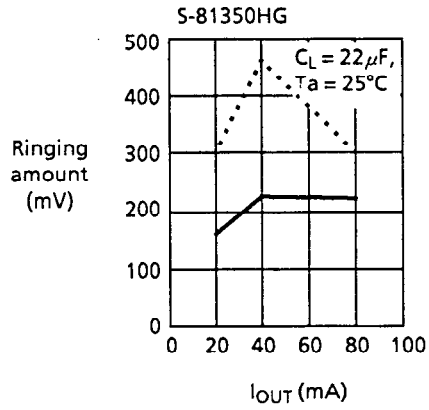
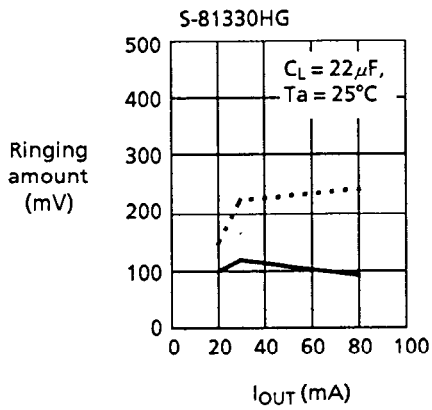

2. C_L dependency

2.1 Overshoot

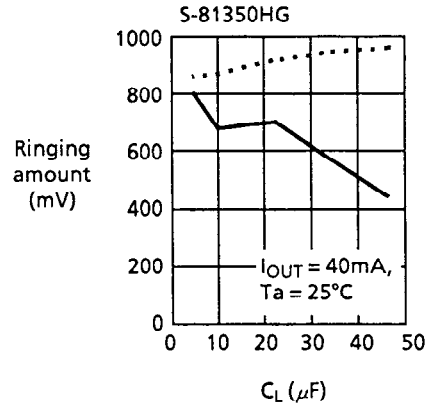
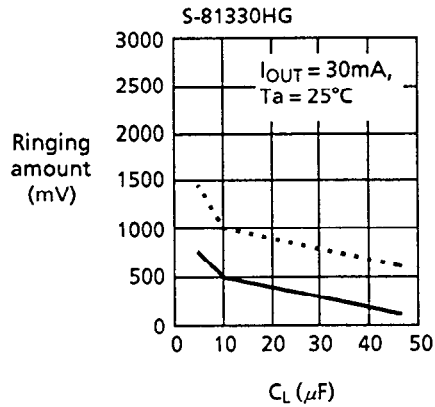

2.2 Undershoot

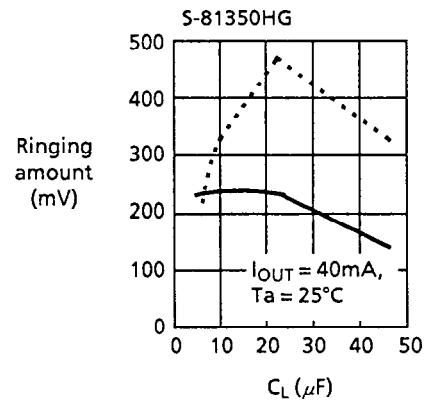
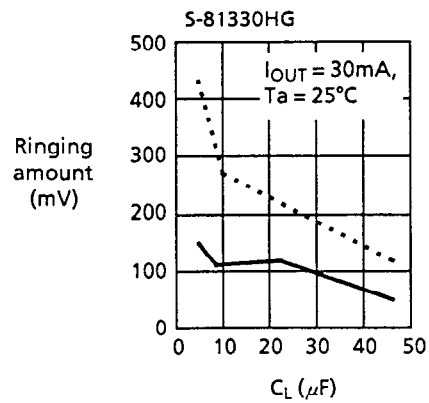

— Typical
 Worst

HIGH-PRECISION VOLTAGE REGULATOR S-813 Series

3. Temperature dependency

www.DataSheet4U.com

3.1 Overshoot

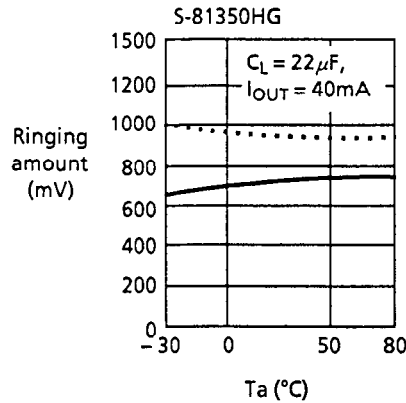
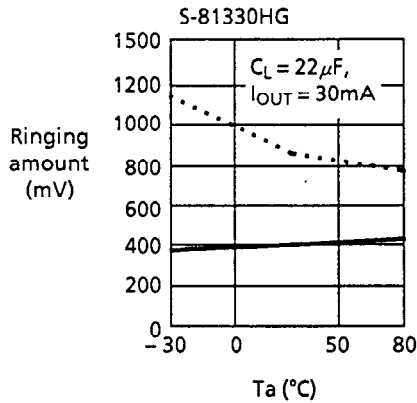

3.2 Undershoot

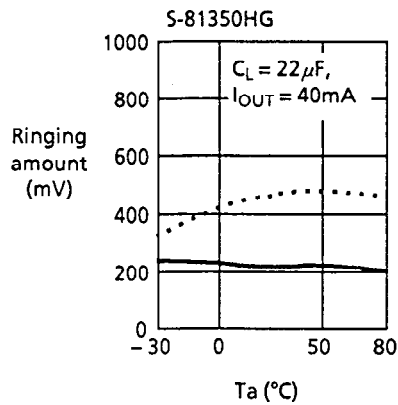
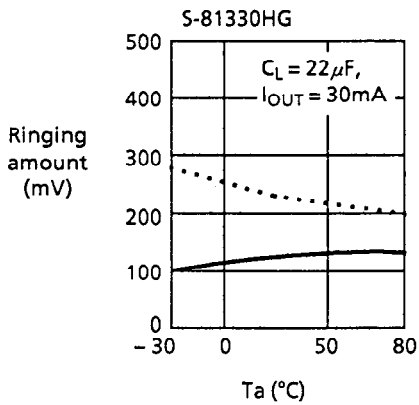

— Typical
..... Worst

2. Load transient response due to output current fluctuation

The overshoot and undershoot are caused in the output voltage if the output current fluctuates between $10\ \mu\text{A}$ and $30\ \text{mA}$ for S-81330HG, and between $50\ \mu\text{A}$ and $40\ \text{mA}$ for S-81350HG while the input voltage is constant. Figure 12 shows the ringing waveform of output voltage due to output current change. Figure 13 shows the measuring circuit for reference.

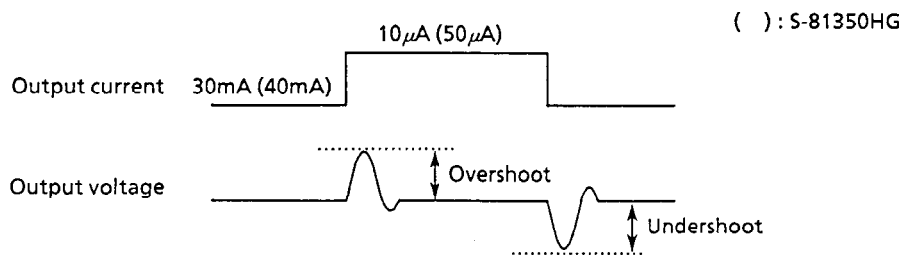

Figure 12 Ringing waveform

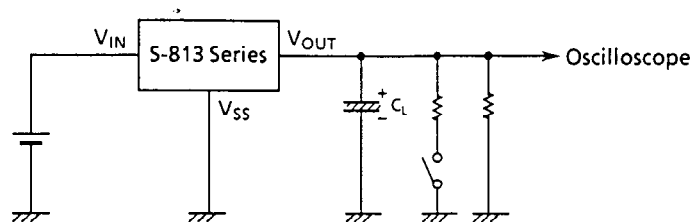
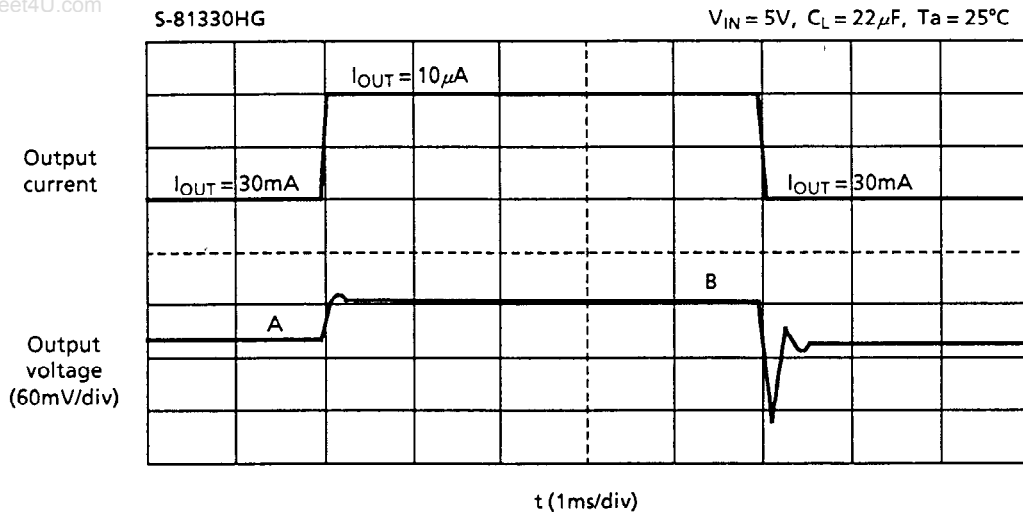

Figure 13 Measuring circuit

Parameter dependency due to output current fluctuation

www.DataSheet4U.com



Output voltage of A and B are different because of voltage drop in output control transistor.

Figure 14

Table 14 Parameter dependency due to output current fluctuation

Parameter	Conditions	Method to decrease overshoot	Method to decrease undershoot
ΔI_{OUT}	Between $50\mu A$ and 40 to 70mA	Decrease	Decrease
C_L	1 to $47\mu F$	Increase	Increase
V_{IN}	S-81330HG : 3.4 to 5V S-81350HG : 5.4 to 7V	No change	No change
T_a	- 30 to + 80°C	High temperature	High temperature

For reference, the following describes the results of measuring the ringing amounts at the V_{OUT} pin using the output current (I_{OUT}), load capacitance (C_L), input voltage (V_{IN}), and temperature (T_a) as parameters.

Reference data : Output current fluctuation

1. I_{OUT} dependency

1.1 Overshoot

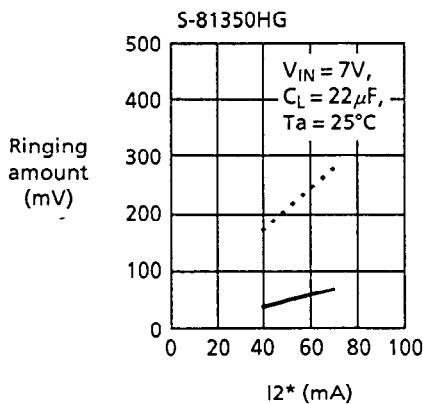

1.2 Undershoot

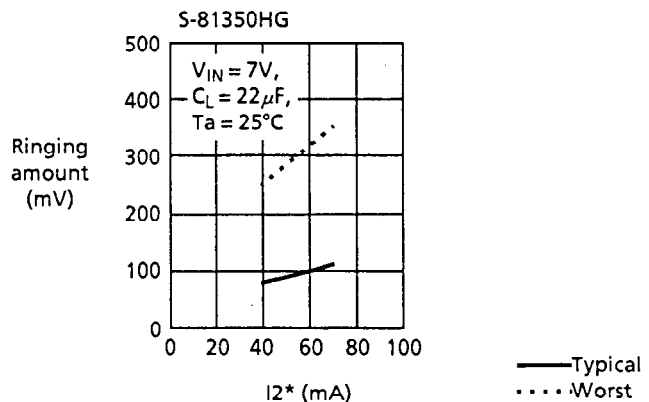

* I_2 represents the higher value of output current fluctuation. The lower value is fixed to $50\mu A$.

Example : when $I_2 = 50mA$, output current fluctuation is between $50\mu A$ and 50mA.

HIGH-PRECISION VOLTAGE REGULATOR

S-813 Series

2. C_L dependency

www.DataSheet4U.com

2.1 Overshoot

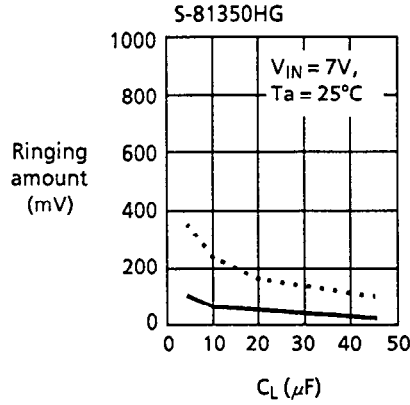
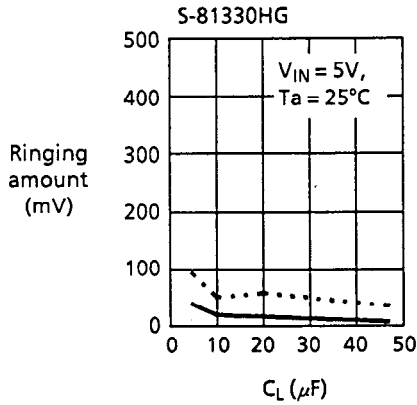

2.2 Undershoot

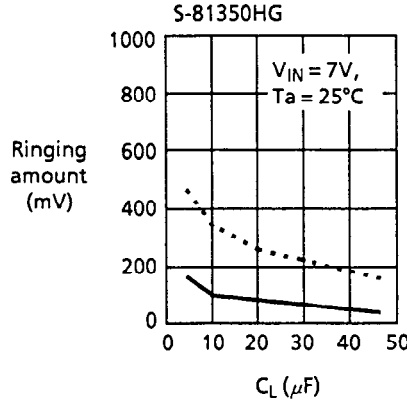
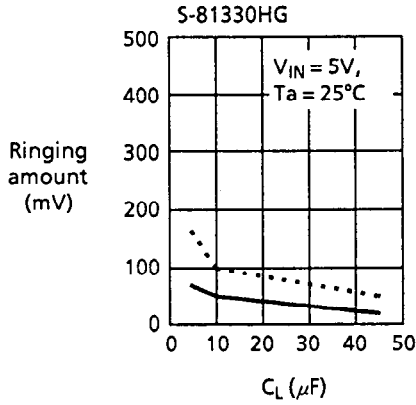

3. V_{IN} dependency

3.1 Overshoot

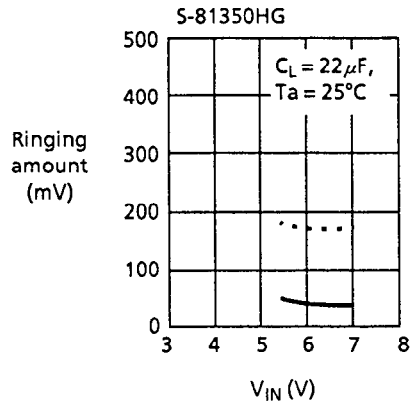
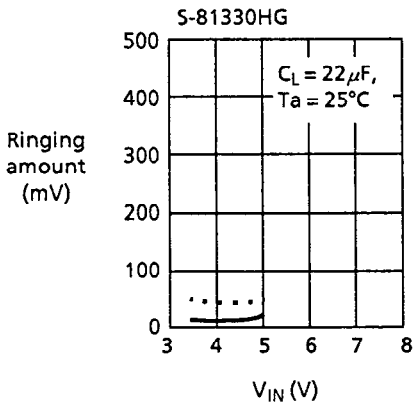

— Typical
 Worst

3.2 Undershoot
www.DataSheet4U.com

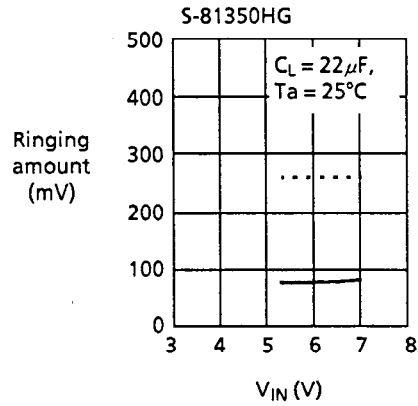
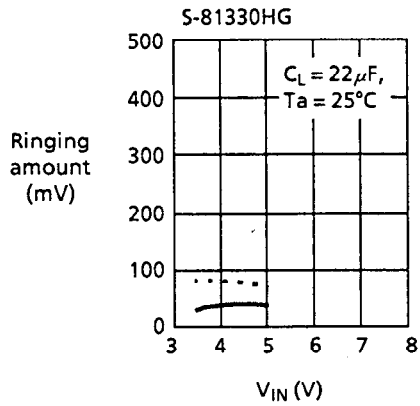

4. Temperature dependency

4.1 Overshoot

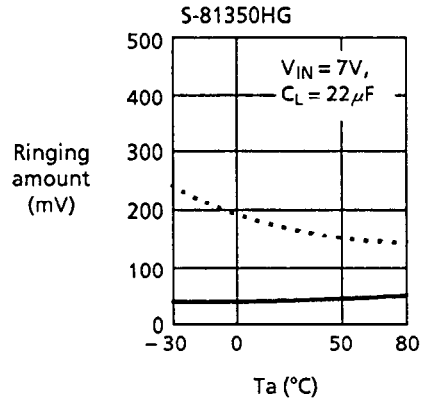
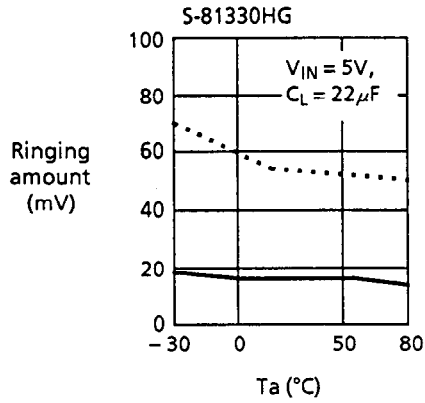

4.2 Undershoot

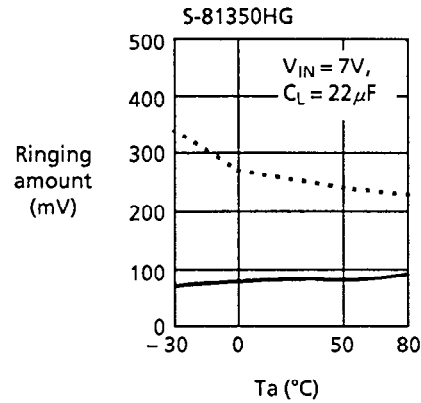
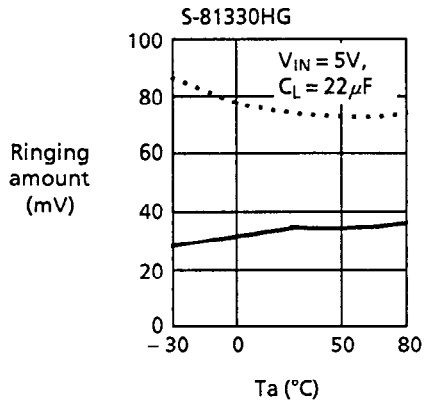

— Typical
 Worst

HIGH-PRECISION VOLTAGE REGULATOR S-813 Series

3. Selecting load capacitance

Results of 1 and 2 demonstrate that undershoot and overshoot appears largest when load capacitance is $4.7\mu\text{F}$ in type I.

Table 15

S-81350HG (worst sample) Ta = 25°C

C_L	$4.7\mu\text{F}$	$10\mu\text{F}$	$22\mu\text{F}$	$47\mu\text{F}$
Overshoot	1822mV	1240mV	903mV	572mV
Undershoot	1182mV	843mV	609mV	372mV

Table 12 demonstrates that overshoot and undershoot generated in output voltage depend upon load capacitance. That is, increasing load capacitance results in decrease in overshoot and undershoot. When determining the load capacitance, take care that the ratings of the ICs or capacitors connected to V_{OUT} terminal are not exceeded because of overshoot. In an application with a voltage detector, select the load capacitance where the voltage detector does not output the reset signal because of undershoot.

■ Dimensions

1. TO-92

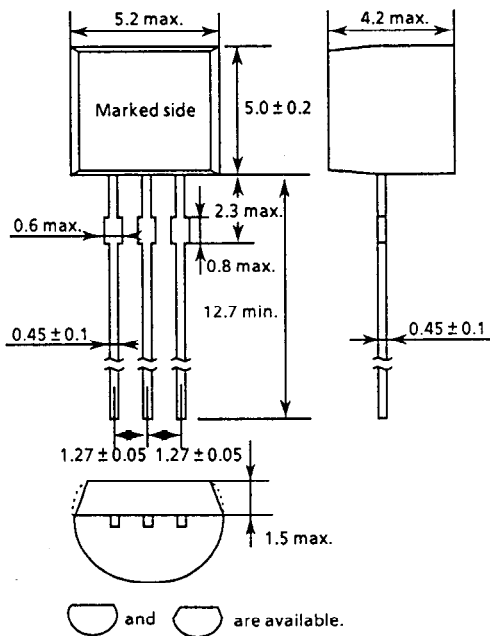

2. SOT-89-3

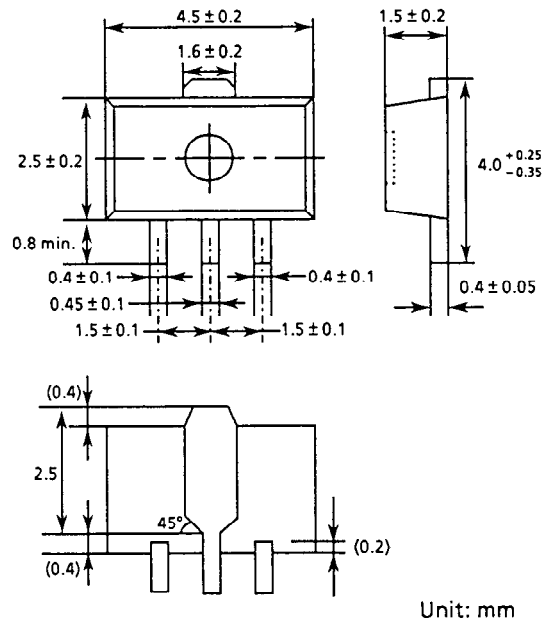
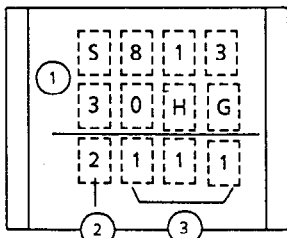

Figure 15

■ Markings

1. TO-92



- ① Product No.
- ② Last digit of the year
- ③ Lot No.

2. SOT-89-3

(1) White label

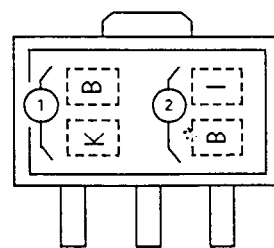

- ① Product No. (abbreviation)
- ② Lot No.

(2) Blue label

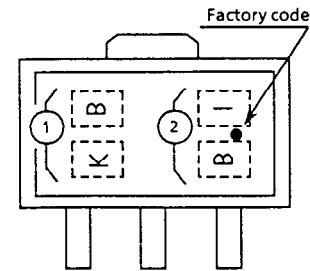

- ① Product No. (abbreviation)
- ② Lot No.

Figure 16 S-81330HG marking example

■ Taping

www.DataSheet4U.com

1. Tape specifications

T1 and T2 types are available depending upon the direction of ICs on the tape.

(1) White label (without a hole in the center of embossed area)

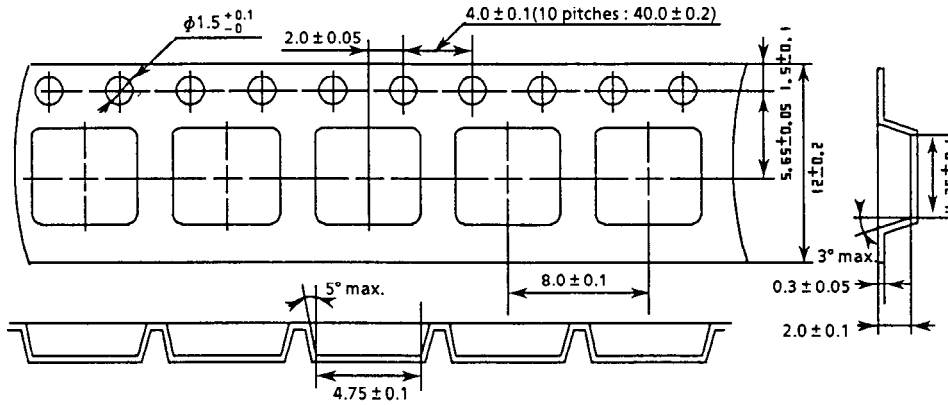

(2) Blue label (with a hole in the center of embossed area)

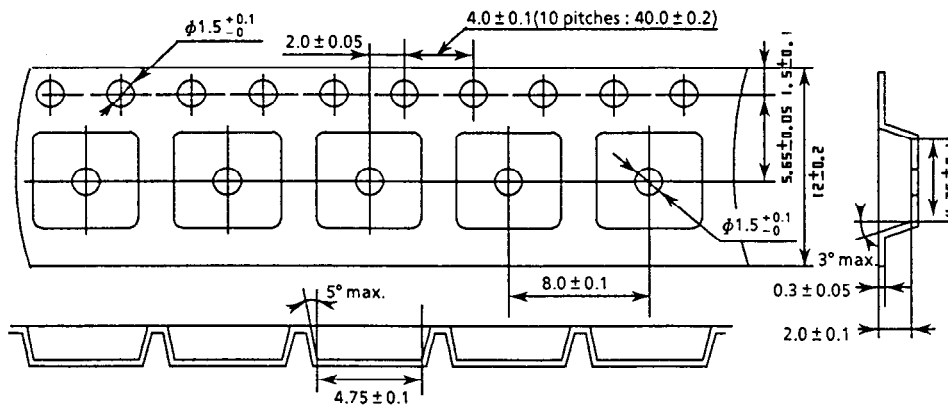

Unit: mm

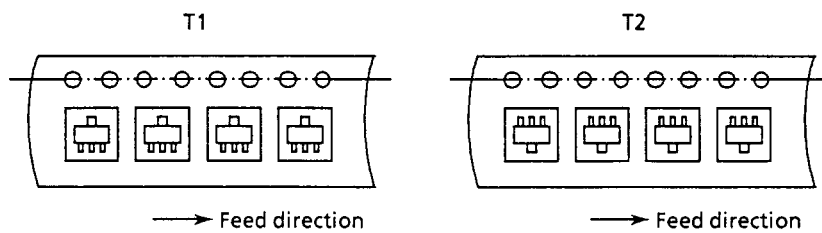

Figure 17

HIGH-PRECISION VOLTAGE REGULATOR S-813 Series

2. Reel specifications

www.DataSheet4U.com

1 reel holds 1000 regulators.

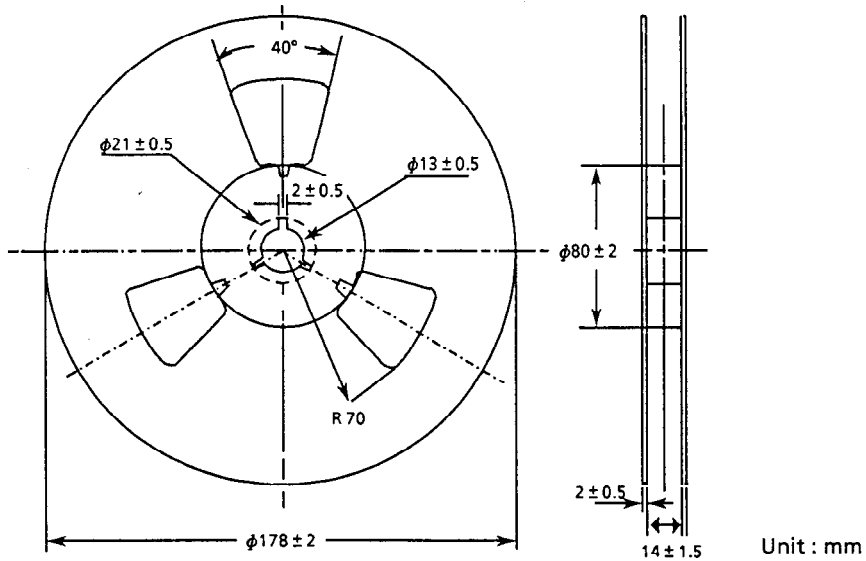

Figure 18

■ Magazine Dimensions

1 stick has 25 regulators.

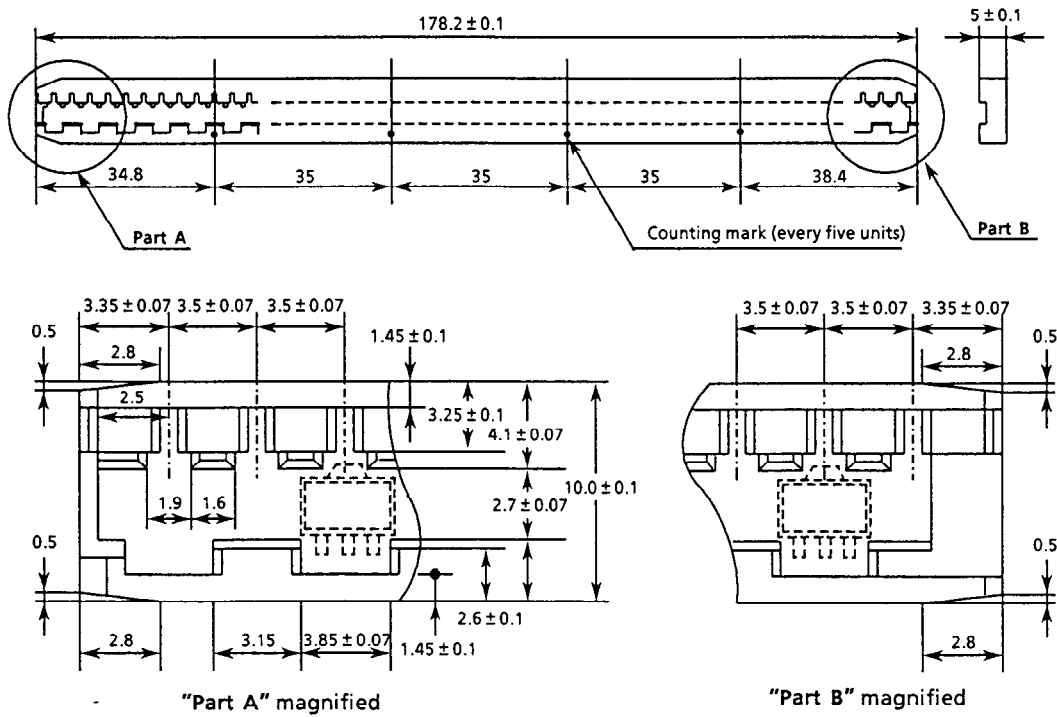

Figure 19

Unit : mm

■ Standard Circuit
www.DataSheet4U.com

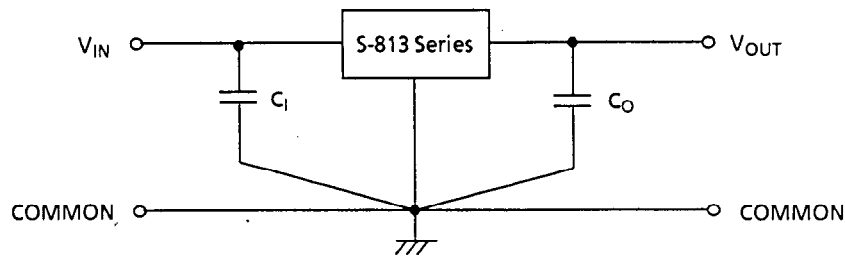

Figure 20 Standard circuit

■ Application Circuits

1. High output current positive voltage regulator

Figure 21 shows a circuit for increasing the output current capacity.

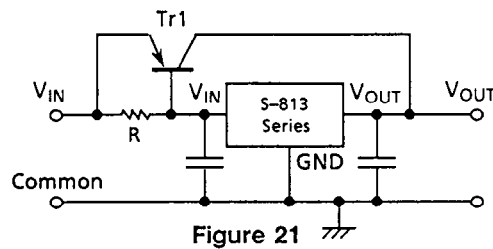

Figure 21

Short-circuit protection of Tr1 is possible by adding the sense resistance R_S and the PNP transistor as shown in Figure 22.

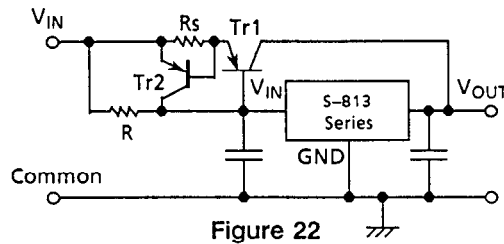

Figure 22

2. Circuits for increasing output voltage

If the output voltage you need cannot be found in our product line-up, the designs in Figures 23 or 24 will increase output voltages easily.

$$V_{OUT} = V_{XX} \left(1 + \frac{R_2}{R_1}\right) + I_{SS} \cdot R_2 \approx V_{XX} \left(1 + \frac{R_2}{R_1}\right)$$

Because of its low current consumption, the S-813 Series can set the resistance values R_1 and R_2 high to lower the power consumption of whole systems.

Current flows to the Zener diode (D_i) through the quiescent current (I_{SS}) of the S-813 Series, and the GND terminal rises for the voltage of D_i . When D_i cannot drive with a quiescent current, connection of the resistance R increases the current flowing through D_i .

Note: Capacitor is connected between V_{OUT} and GND. In applications that need high output voltage, V_{OUT} voltage is higher than GND voltage when the power turns on.

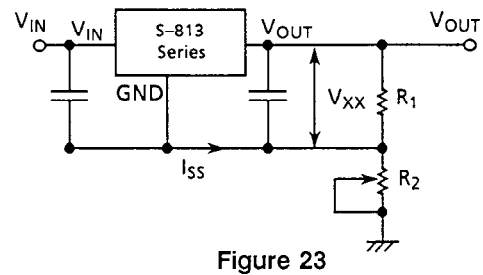

Figure 23

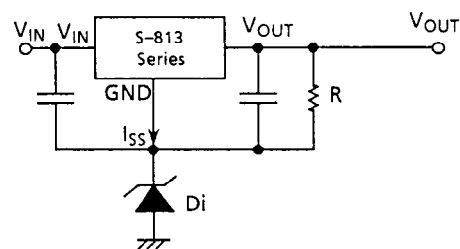

Figure 24

HIGH-PRECISION VOLTAGE REGULATOR S-813 Series

3. Constant current regulator

The S-813 Series can be used as a constant-current regulator within allowable dissipation limits.

$$I_{OUT} = \frac{V_{XX}}{R_A} + I_{SS}$$

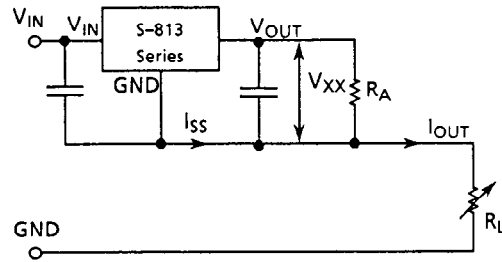

Figure 25 Constant current regulator

Notes on Design

- Voltage regulators may oscillate if small or zero capacity is connected to IC input when the impedance of the power source is high and a large capacity is connected to IC output.
- In TO-92 products, since there are projections and resin burrs on the roots of lead terminals formed at Tiebar-cut, do not solder on them.
- Because the S-813 Series voltage regulators do not contain short circuit protection circuit, short-circuiting which occurs during mounting or other operations may cause damage to the component.
- Do not apply a ripple voltage of the conditions below to V_{IN} terminal.

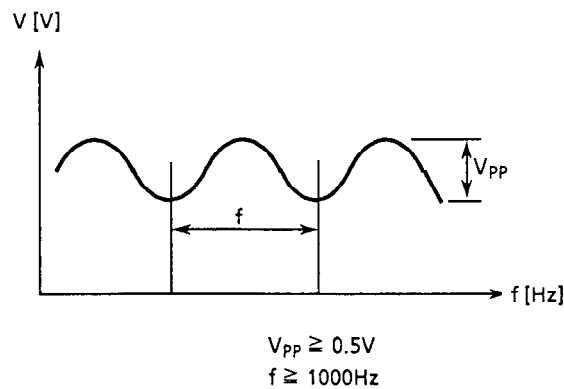

Figure 26

- When connecting the voltage regulator output terminal to another power supply, please insert a diode to protect the IC.

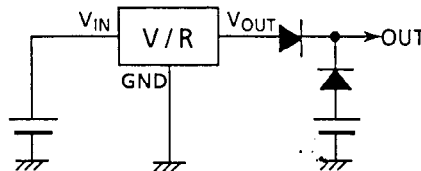

Figure 27

■ Characteristics

1. Input voltage (V_{IN}) - Output voltage (V_{OUT})

1.1 When ambient temperature is fixed

(1) S-81330HG

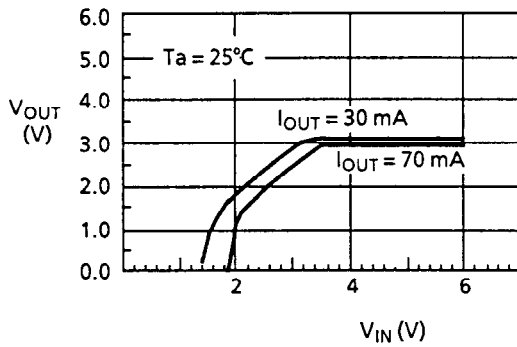

(2) S-81332HG

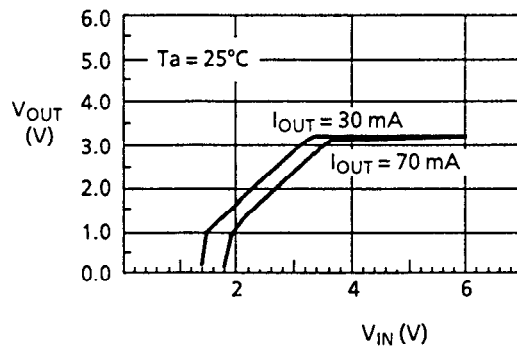

(3) S-81350HG

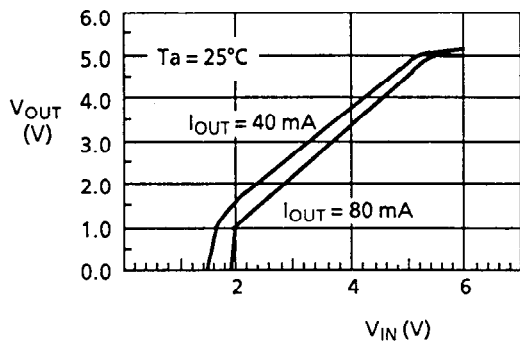

1.2 When output current is fixed

(1) S-81330HG

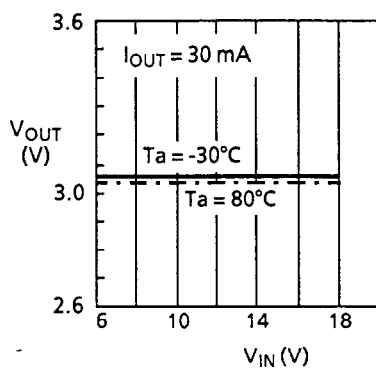

(2) S-81332HG

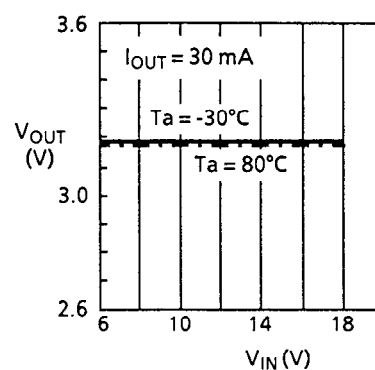

HIGH-PRECISION VOLTAGE REGULATOR S-813 Series

www.DataSheet4U.com
(3) S-81350HG

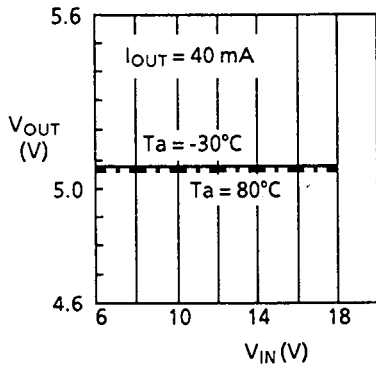

2. Output current (I_{OUT}) - Output voltage (V_{OUT})

2.1 S-81330HG

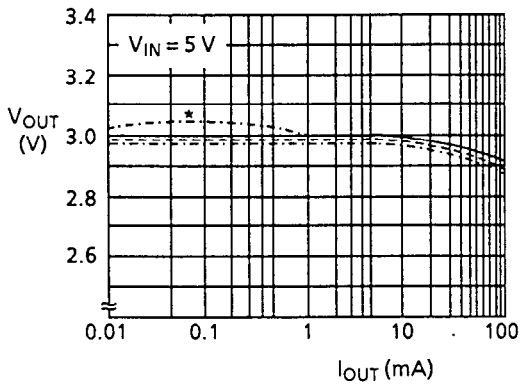

2.2 S-81332HG

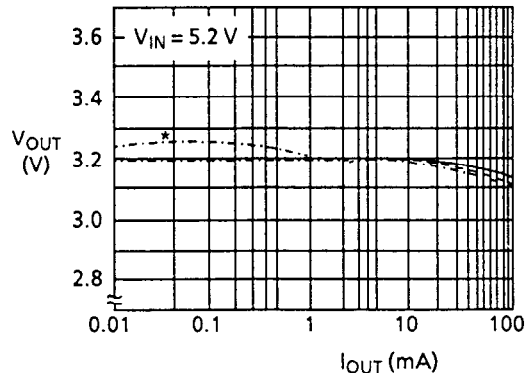

2.3 S-81350HG

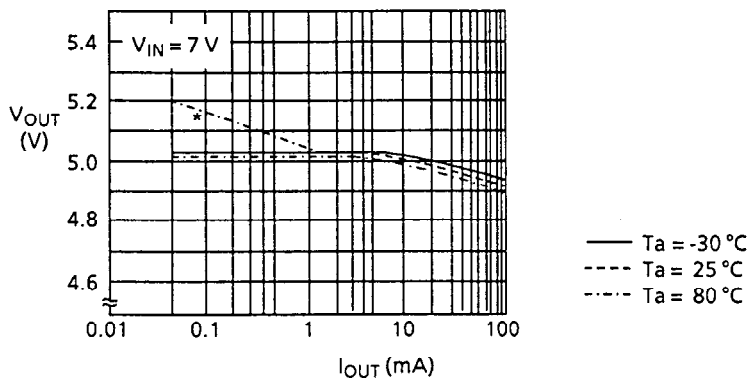

* In applications whose output current is small, the load stability may be bad at high temperature.

3. Current consumption
www.DataSheet4U.com

3.1 S-81330HG

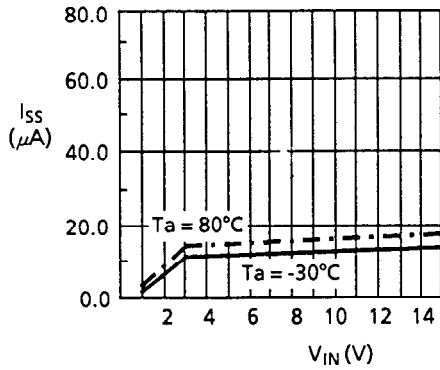

3.2 S-81332HG

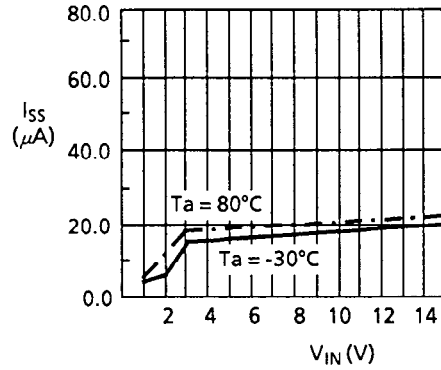

3.3 S-81350HG

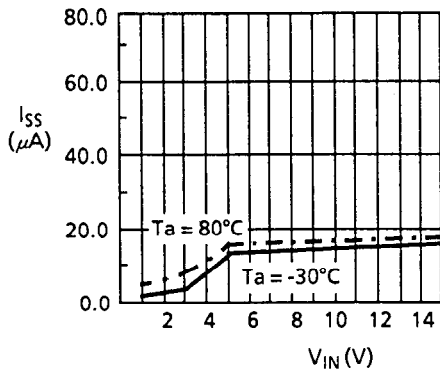

4. Output voltage (V_{OUT}) - Temperature (T_a)

4.1 S-81330HG, S-81332HG

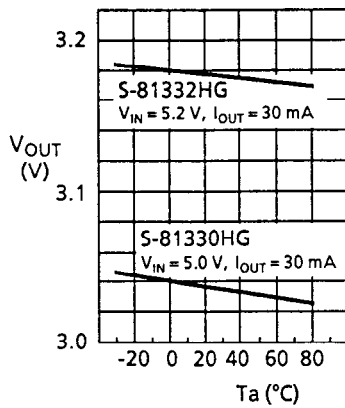

4.2 S-81350HG

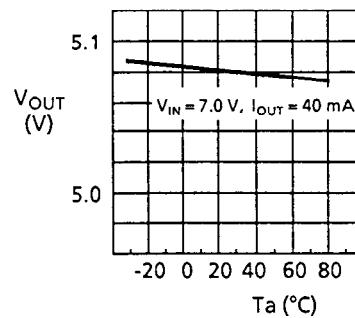

HIGH-PRECISION VOLTAGE REGULATOR

S-813 Series

5. Input/output voltage difference (V_{dif}) (See p3-113 for the definition of V_{dif})

5.1 S-81330HG

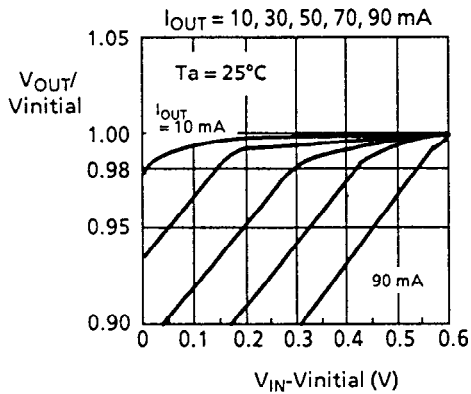

5.2 S-81332HG

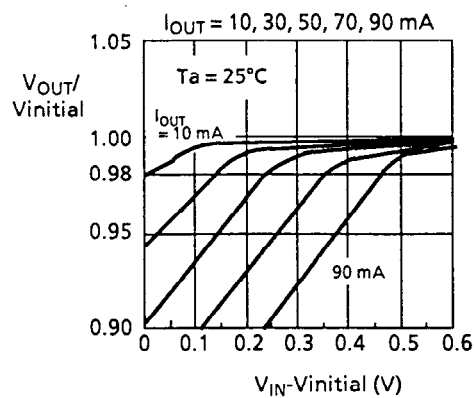

5.3 S-81350HG

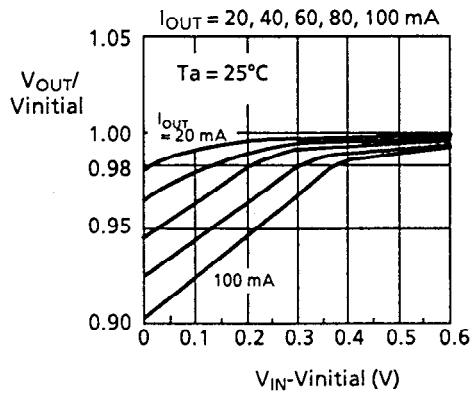

• Definition of $V_{initial}$

S-81330HG : Output voltage value when V_{IN} is 5 V and I_{OUT} is 30 mA

S-81332HG : Output voltage value when V_{IN} is 5.2 V and I_{OUT} is 30 mA

S-81350HG : Output voltage value when V_{IN} is 7 V and I_{OUT} is 40 mA

6. Output current (I_{OUT}) - Input/output voltage difference (V_{dif})

6.1 S-81330HG

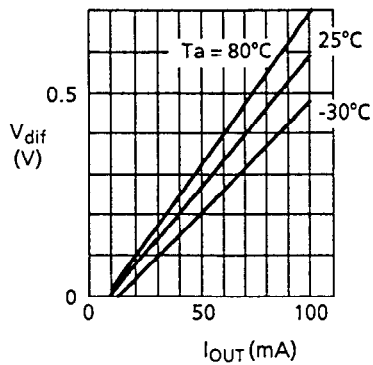

6.2 S-81332HG

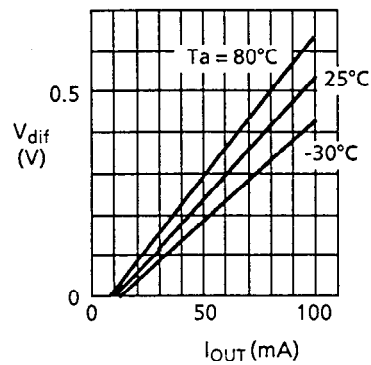

www.DataSheet4U.com
6.3 S-81350HG

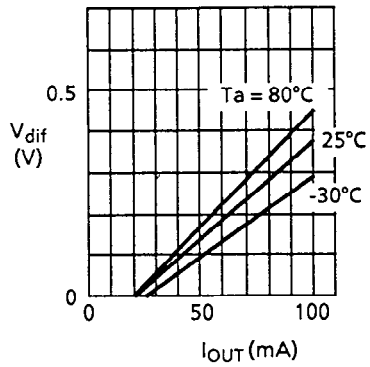

7. Ripple rejection

7.1 S-81330HG

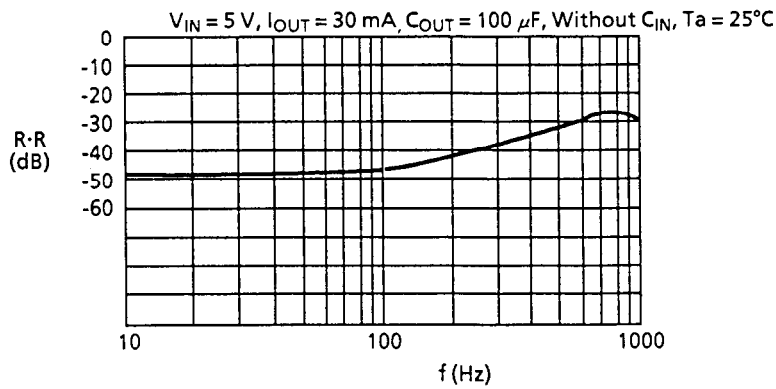

7.2 S-81350HG

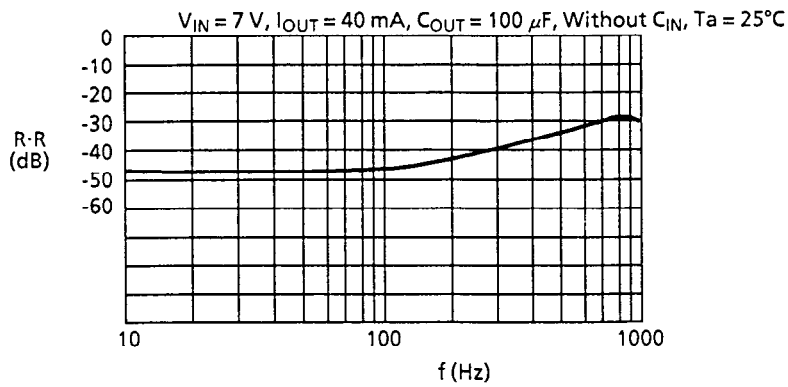

HIGH-PRECISION VOLTAGE REGULATOR S-813 Series

■ Measuring Circuits

www.DataSheet4U.com

(1), (2), (4), (5), (6)

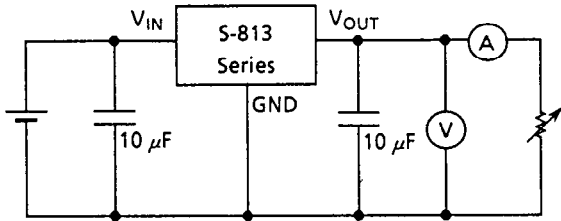

(3)

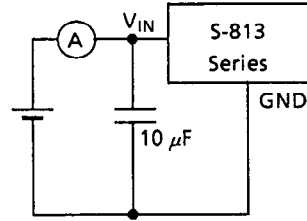

(7)

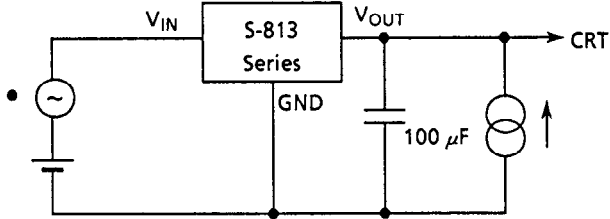

Figure 28