

Panasonic

DVD Stereo System Operating Instructions

Model No. **SC-PM39D**

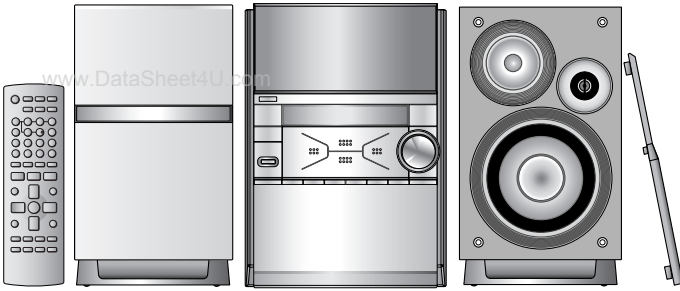

Before connecting, operating or adjusting this product, please read these instructions completely. Please keep this manual for future reference.



Region number

The player plays DVD-Video marked with labels containing the region number or "ALL".

Region	Number
For U.S.A. and Canada	1
For Latin America	4

Example: For U.S.A. and Canada



For U.S.A. only

The warranty can be found on page 39.

For U.S.A. and Canada only



ENERGY STAR

As an ENERGY STAR® Partner®, Panasonic has determined that this product meets the ENERGY STAR® guidelines for energy efficiency.

*For Canada only: The word "Participant" is used in place of the word "Partner".

Dear customer

Thank you for purchasing this product. For optimum performance and safety, please read these instructions carefully.

Operations in these instructions are described mainly for the remote control, but you can do the operations on the main unit if the controls are the same.

System	SC-PM39D
Main unit	SA-PM39D
Speakers	SB-PM39

Getting started

CAUTION!

THIS PRODUCT UTILIZES A LASER. USE OF CONTROLS OR ADJUSTMENTS OR PERFORMANCE OF PROCEDURES OTHER THAN THOSE SPECIFIED HEREIN MAY RESULT IN HAZARDOUS RADIATION EXPOSURE. DO NOT OPEN COVERS AND DO NOT REPAIR YOURSELF. REFER SERVICING TO QUALIFIED PERSONNEL.



WARNING:

TO REDUCE THE RISK OF FIRE, ELECTRIC SHOCK OR PRODUCT DAMAGE, DO NOT EXPOSE THIS APPARATUS TO RAIN, MOISTURE, DRIPPING OR SPLASHING AND THAT NO OBJECTS FILLED WITH LIQUIDS, SUCH AS VASES, SHALL BE PLACED ON THE APPARATUS.

CAUTION!

DO NOT INSTALL OR PLACE THIS UNIT IN A BOOK-CASE, BUILT-IN CABINET OR IN ANOTHER CONFINED SPACE. ENSURE THE UNIT IS WELL VENTILATED. TO PREVENT RISK OF ELECTRIC SHOCK OR FIRE HAZARD DUE TO OVERHEATING, ENSURE THAT CURTAINS AND ANY OTHER MATERIALS DO NOT OBSTRUCT THE VENTILATION VENTS.

THE FOLLOWING APPLIES ONLY IN THE U.S.A. AND CANADA

	CAUTION RISK OF ELECTRIC SHOCK DO NOT OPEN	
<p>CAUTION: TO REDUCE THE RISK OF ELECTRIC SHOCK, DO NOT REMOVE SCREWS. NO USER-SERVICEABLE PARTS INSIDE. REFER SERVICING TO QUALIFIED SERVICE PERSONNEL.</p>		

 The lightning flash with arrowhead symbol, within an equilateral triangle, is intended to alert the user to the presence of uninsulated "dangerous voltage" within the product's enclosure that may be of sufficient magnitude to constitute a risk of electric shock to persons.

 The exclamation point within an equilateral triangle is intended to alert the user to the presence of important operating and maintenance (servicing) instructions in the literature accompanying the appliance.

CAUTION	- LASER RADIATION WHEN OPEN. DO NOT STARE INTO BEAM. FDA 21 CFR / Class II
CAUTION	- VISIBLE AND INVISIBLE LASER RADIATION WHEN OPEN. AVOID EXPOSURE TO BEAM. IEC60825-1 / Class 3b
WARNING	- SYNLIG OCH OSYNLIG LASERSTRÅLNING NÄR DENNA DEL ÄR ÖPPNAD. BETRÄKTA EJ STRÅLEN.
ADVARSEL	- SYNLIG OG USYNLIG LASERSTRÅLING VED ÅBNING. UNDGÅ UDSÆTTELSE FOR STRÅLING.
ADVARSEL	- SYNLIG OG USYNLIG LASERSTRÅLING NÄR DEKSEL ÅPNS. UNNGÅ EKSPONERING FÖR STRÅLEN.
VARO!	- AVATTAESSA OLET ALTTIINA NÄKYVÄÄ JA NÄKYMÄTÖN LASERSÄTEILILLE. ÄLÄ KATSO SÄTEESEEN.
VORSICHT	- SICHTBARE UND UNSICHTBARE LASERSTRÄHLUNG. WEINN ABDECKUNG GEÖFFNET, NICHT DEM STRAHL AUSSETZEN.
ATTENTION	- RAYONNEMENT LASER VISIBLE ET INVISIBLE EN CAS D'OUVERTURE. EXPOSITION DANGEREUSE AU FAISCEAU.
注意	- 打开時有可能及不可見激光照射。避免激光照射。
注意	- ここを開くと可視及び不可視レーザー光が出ます。ビームを見たり、触れたりしないで下さい。 RQ7XS0054

(Inside of product)

THE FOLLOWING APPLIES ONLY IN THE U.S.A.

CAUTION:

This equipment has been tested and found to comply with the limits for a Class B digital device, pursuant to Part 15 of the FCC Rules.

These limits are designed to provide reasonable protection against harmful interference in a residential installation. This equipment generates, uses and can radiate radio frequency energy and, if not installed and used in accordance with the instructions, may cause harmful interference to radio communications. However, there is no guarantee that interference will not occur in a particular installation. If this equipment does cause harmful interference to radio or television reception, which can be determined by turning the equipment off and on, the user is encouraged to try to correct the interference by one or more of the following measures:

- Reorient or relocate the receiving antenna.
- Increase the separation between the equipment and receiver.
- Connect the equipment into an outlet on a circuit different from that to which the receiver is connected.
- Consult the dealer or an experienced radio/TV technician for help.

Any unauthorized changes or modifications to this equipment would void the user's authority to operate this device.

This device complies with Part 15 of the FCC Rules. Operation is subject to the following two conditions: (1) This device may not cause harmful interference, and (2) this device must accept any interference received, including interference that may cause undesired operation.

Table of contents

Accessories



Please check and identify the supplied accessories.
Use numbers indicated in parentheses when asking for replacement parts.

In U.S.A. to order accessories, refer to "Accessory Purchases" on page 39.

- 1 Remote control (N2QAJB000098)



- 2 Batteries for remote control



- 1 AC power supply cord (K2CB2CB00006)

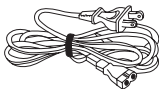

- 1 AM loop antenna (N1DAAAA00001)



- 1 FM indoor antenna (RSA0007-L)

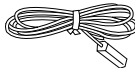

- 1 Video cable (RJL1P016B15A)



- 1 Antenna plug
For U.S.A. and Canada only
(K2RC021B0001)



Note

The included AC power supply cord is for use with this unit only. Do not use it with other equipment.

User memo:

DATE OF PURCHASE _____
 DEALER NAME _____
 DEALER ADDRESS _____
 TELEPHONE NUMBER _____

The model number and serial number of this product can be found on either the back or the bottom of the unit. Please note them in the space provided below and keep for future reference.

MODEL NUMBER _____ SC-PM39D
 SERIAL NUMBER _____

Getting started

Accessories	3
IMPORTANT SAFETY INSTRUCTIONS	4
Product Service	4
Disc information	5
Simple setup	
STEP1 Positioning	6
STEP2 Connecting the speakers	6
STEP3 Television	7
STEP4 Connecting the antennas and AC power supply cord	8
STEP5 The remote control	8
STEP6 QUICK SETUP	9
STEP7 Setting the time	9
DEMO function	9

Control reference guide	10
-------------------------------	----

Disc operations

Discs — Basic play	12
Discs — Convenient functions	14
Soundtracks / Subtitle	14
Position memory / Repeat play	14
Random play	15
Program play (up to 24 items)	15
Discs — Using navigation menus	16
Using the tree screen to find a group	16
Using a contents screen to find a track	16
Using the submenu	16
Playing HighMAT discs	17
Playing programs on DVD-RAM	18
Using the play list on DVD-RAM	18
Discs — Using On-screen menu	19
To get disc information or to play from a specified item	19
To see the playback position	21

Radio operations

The radio	22
Manual tuning / Preset tuning	22

Tape operations

Cassette tapes	23
----------------------	----

Recording operations

Recording	24
-----------------	----

Sound field and sound quality operations

Sound field and sound quality	25
Advanced Surround	25
Multi Re-master — Enjoying more natural sound	25
Changing sound field and quality	25
To enjoy even higher quality sound—AUDIO ONLY	25

Other functions

Convenient functions	26
Auto-off function / Dimming the display	26
Enjoying more powerful bass	26
Muting the volume / Using headphones	26
The play/record timer	27
The sleep timer / Operating a television	28
Discs — Changing the player's settings	29
Digital output	31
Using other equipment	32
Home Theater — Enjoying more powerful sound	32
Using an external unit	32
Optional antenna connections	33

Reference

Troubleshooting guide	34
Maintenance	36
When moving the unit	36
Glossary	37
Tray/disc handling procedure	37
Specifications	38

IMPORTANT SAFETY INSTRUCTIONS

Read these operating instructions carefully before using the unit. Follow the safety instructions on the unit and the applicable safety instructions listed below. Keep these operating instructions handy for future reference.

Getting started

- 1) Read these instructions.
www.DataSheet4U.com
- 2) Keep these instructions.
- 3) Heed all warnings.
- 4) Follow all instructions.
- 5) Do not use this apparatus near water.
- 6) Clean only with dry cloth.
- 7) Do not block any ventilation openings. Install in accordance with the manufacturer's instructions.
- 8) Do not install near any heat sources such as radiators, heat registers, stoves, or other apparatus (including amplifiers) that produce heat.
- 9) Do not defeat the safety purpose of the polarized or grounding-type plug. A polarized plug has two blades with one wider than the other. A grounding-type plug has two blades and a third grounding prong. The wide blade or the third prong are provided for your safety. If the provided plug does not fit into your outlet, consult an electrician for replacement of the obsolete outlet.
- 10) Protect the power cord from being walked on or pinched particularly at plugs, convenience receptacles, and the point where they exit from the apparatus.
- 11) Only use attachments/accessories specified by the manufacturer.
- 12) Use only with the cart, stand, tripod, bracket, or table specified by the manufacturer, or sold with the apparatus. When a cart is used, use caution when moving the cart/apparatus combination to avoid injury from tip-over.
- 13) Unplug this apparatus during lightning storms or when unused for long periods of time.
- 14) Refer all servicing to qualified service personnel. Servicing is required when the apparatus has been damaged in any way, such as power-supply cord or plug is damaged, liquid has been spilled or objects have fallen into the apparatus, the apparatus has been exposed to rain or moisture, does not operate normally, or has been dropped.



Product Service

1. **Damage requiring service**—The unit should be serviced by qualified service personnel if:
 - (a) The AC power supply cord or AC adaptor has been damaged; or
 - (b) Objects or liquids have gotten into the unit; or
 - (c) The unit has been exposed to rain; or
 - (d) The unit does not operate normally or exhibits a marked change in performance; or
 - (e) The unit has been dropped or the cabinet damaged.
2. **Servicing**—Do not attempt to service the unit beyond that described in these operating instructions. Refer all other servicing to authorized servicing personnel.
3. **Replacement parts**—When parts need replacing ensure the servicer uses parts specified by the manufacturer or parts that have the same characteristics as the original parts. Unauthorized substitutes may result in fire, electric shock, or other hazards.
4. **Safety check**—After repairs or service, ask the servicer to perform safety checks to confirm that the unit is in proper working condition.

Product information

For product information or assistance with product operation:

In the U.S.A., refer to "Customer Services Directory" on page 39.

In Canada, contact the Panasonic Canada Inc. Customer Care Centre at 1-800-561-5505, or visit the website (www.panasonic.ca), or an authorized Servicentre closest to you.

Disc information

Discs that can be played

Disc	Logo <small>www.DataSheet4U.com</small>	Indication in these operating instructions	Remarks
DVD-RAM		RAM	Recorded using Version 1.1 of the Video Recording Format (a unified video recording standard). • Recorded with DVD-Video recorders, DVD-Video cameras, personal computers, etc. • Remove discs from their cartridges before use.
		JPEG	Recorded using the DCF (Design rule for Camera File system) standard. • Recorded with Panasonic DVD-Video recorders. • To play JPEG files, select "Play as Data Disc" in Other Menu (⇒ page 21).
DVD-Audio		DVD-A	—
		DVD-V	Some DVD-Audio discs contain DVD-Video content. To play DVD-Video content, select "Play as DVD-Video" in Other Menu (⇒ page 21).
DVD-Video		DVD-V	—
DVD-R			Panasonic DVD-R recorded and finalized* on a Panasonic DVD-Video recorder or DVD-Video camera are played as DVD-Video on this unit.
Video CD		VCD	—
SVCD			Conforming to IEC62107.
CD		CD	This unit is compatible with HDCD, but does not support Peak Extend function (A function which expands the dynamic range of high level signals). HDCD-encoded CDs sound better because they are encoded with 20 bits, compared with 16 bits for all other CDs. • During HDCD play, "HDCD" appears on the unit's display.
CD-R CD-RW	—	WMA MP3 JPEG CD VCD	• This unit can play CD-R/RW (audio recording disc) recorded with the formats on the left. Close the session or finalize* the disc after recording. • HighMAT discs WMA, MP3 or JPEG files only. To play without using the HighMAT function, select "Play as Data Disc" in Other Menu (⇒ page 21).

* A process that allows play on compatible equipment.

• It may not be possible to play the above discs in all cases due to the type of disc or condition of the recording.

Discs that cannot be played

DVD-ROM, CD-ROM, CDV, CD-G, DVD+R, +RW, DVD-RW, SACD, Divx Video Discs and Photo CD, DVD-RAM that cannot be removed from its cartridge, 2.6-GB and 5.2-GB DVD-RAM, and "Chaoji VCD" available on the market including CVD, DVCD and SVCD that do not conform to IEC62107.

Audio format of DVDs

This unit automatically recognizes and decodes discs with these symbols.



Playing DVDs and Video CDs

The producer of these discs can control how they are played so you may not always be able to control play as described in these operating instructions (for example if the play time is not displayed or if a Video CD has menus). Read the disc's instructions carefully.

To clean discs

DVD-A DVD-V VCD CD

Wipe with a damp cloth and then wipe dry.

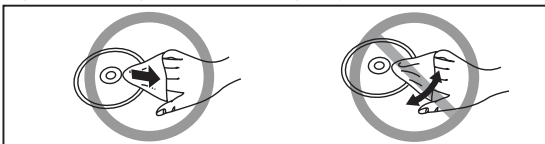

RAM DVD-R

- Clean with an optional DVD-RAM/PD disc cleaner (LF-K200DCA1, where available).
- Never use cloths or cleaners for CDs, etc.

Disc handling precautions

- Do not attach labels or stickers to discs (This may cause disc warping, rendering it unusable).
- Do not write on the label side with a ball-point pen or other hard writing instrument.
- Do not use record cleaning sprays, benzine, thinner, static electricity prevention liquids or any other solvent.
- Do not use scratch-proof protectors or covers.
- Do not use the following discs:
 - Discs with exposed adhesive from removed stickers or labels (rented discs, etc).
 - Discs that are badly warped or cracked.
 - Irregularly shaped discs, such as heart shapes.

Playing PAL system DVD-Audio

This unit converts PAL to NTSC for play. The picture is compressed to show it in its entirety, but this may cause it to be stretched vertically.

Simple setup

STEP 1

Positioning

www.DataSheet4U.com

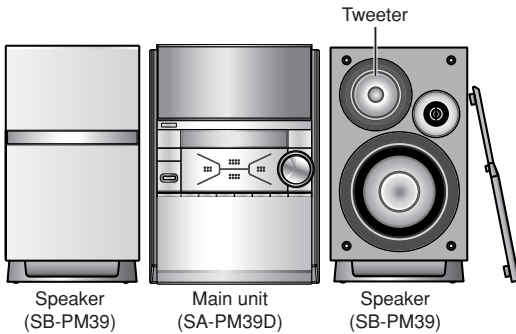

Place the speakers so that the tweeter is on the inside.

Use only supplied speakers

Using other speakers can damage the unit and sound quality will be negatively affected.

- Set the speakers up on an even surface to prevent them from falling. Take proper precautions to prevent the speakers from falling if you cannot set them up on an even surface.

Positioning for best effect

How you set up your speakers can affect the bass and the sound field. Note the following points.

- Place speakers on flat secure bases.
- Placing speakers too close to floors, walls, and corners can result in excessive bass. Cover walls and windows with a thick curtain.
- Keep your speakers at least 10 mm (13/32") away from the system for proper ventilation.
- To avoid damage to the speakers, do not touch the speaker cones if you have taken the nets off.

Notes on speaker use

- You can damage your speakers and shorten their useful life if you play sound at high levels over extended periods.
- Reduce the volume in the following cases to avoid damage.
 - When playing distorted sound.
 - When the speakers emit strange noise (howling) from a record player, noise from FM broadcasts, or continuous signals from an oscillator, test disc, or electronic instrument.
 - When adjusting the sound quality.
 - When turning the unit on or off.

If irregular coloring occurs on your television

These speakers are designed to be used close to a television, but the picture may be affected with some televisions and set-up combinations.

If this occurs, turn the television off for about 30 minutes.

The television's demagnetizing function should correct the problem. If it persists, move the speakers further away from the television.



Caution

- Use the speakers only with the recommended system. Failure to do so may lead to damage to the amplifier and/or the speakers, and may result in the risk of fire. Consult a qualified service person if damage has occurred or if you experience a sudden change in performance.
- Do not attach these speakers to walls or ceilings.

STEP 2

Connecting the speakers

Twist the vinyl tip and pull off.

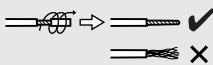

Confirm the colors of the tags on the ends of the cords.

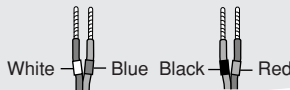

Note

- Never short-circuit positive (+) and negative (-) speaker wires.
- Be sure to connect only positive (copper) wires to positive (+) terminals and negative (silver) wires to negative (-) terminals. Incorrect connection can damage the speakers.

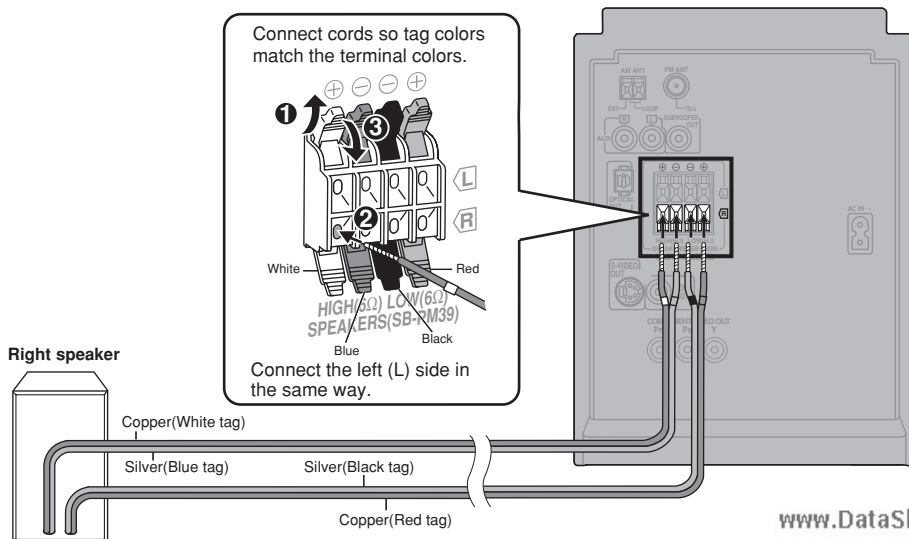

STEP 3 Television

www.DataSheet4U.com

■ Connecting a television with a VIDEO IN terminal

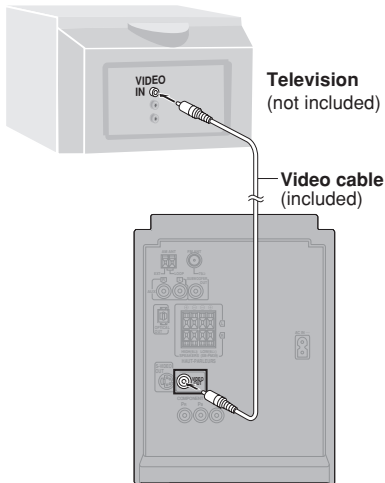

VIDEO OUT terminal

Do not connect the unit through a video cassette recorder, because the picture may not be played correctly due to the copy guard.

■ Connecting a television with an S-VIDEO IN terminal

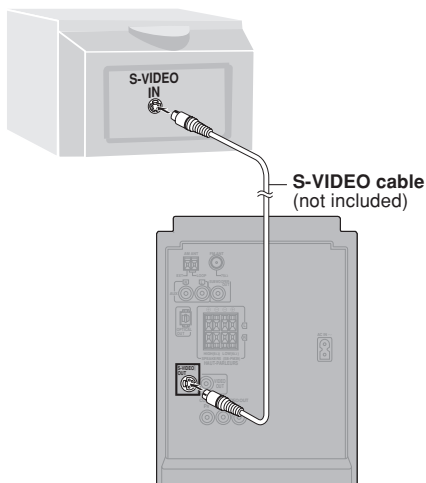

S-VIDEO OUT terminal

The S-VIDEO terminal achieves a more vivid picture than the VIDEO OUT terminal by separating the chrominance (C) and luminance (Y) signals. (Actual results depend on the television.)

Video cable



■ Connecting a television with COMPONENT VIDEO IN terminals

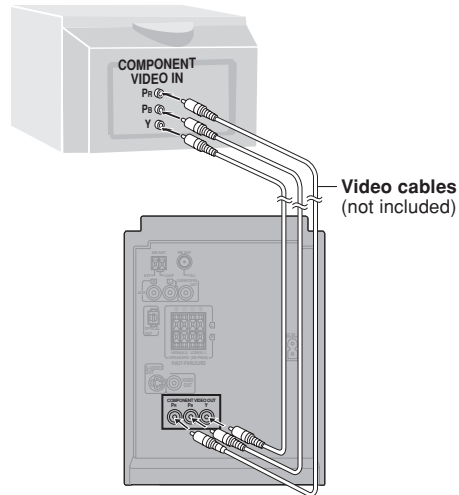

COMPONENT VIDEO OUT terminals

These terminals can be used for either interlace or progressive output and provide a purer picture than the S-VIDEO OUT terminal. Connection using these terminals outputs the color difference signals (P_B/P_R) and luminance signal (Y) separately in order to achieve high fidelity in reproducing colors. The description of the component video input terminals depends on the television or monitor (e.g. Y/P_B/P_R, Y/B-Y/R-Y, Y/C_B/C_R). Connect to terminals of the same color.

- After making this connection, change the black level for a better picture (→ page 29, "Video" tab - Black Level Control).

To enjoy progressive video

1. Connect to the component video input terminals on a 480P compatible television. (Video will not be displayed correctly if connected to an incompatible television.)
 2. In QUICK SETUP, set "Progressive Out" to "Enable".
 3. Change "Progressive" to "480P" (→ page 20, Picture Menu—Video Output Mode).
- All televisions manufactured by Panasonic and that have 480P input connectors are compatible. Consult the manufacturer if you have another brand of television.
 - If the unit is connected to the television through VIDEO OUT or S-VIDEO OUT, output will be interlace, irrespective of the settings.

STEP 4

Connecting the antennas and AC power supply cord

Connect the AC power supply after all other connections are complete.

AM loop antenna



FM indoor antenna



AC power supply cord



Conserving power

The unit consumes power (approx. 0.5 W) even when it is turned off with [⏻]. To save power when the unit is not to be used for a long time, unplug it from the household AC outlet. You will need to reset some memory items after plugging in the unit.

AM loop antenna

Stand the antenna up on its base.
Keep loose antenna cord away from other wires and cords.

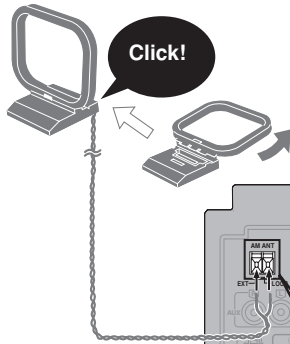

FM indoor antenna

Fix the other end of the antenna where reception is best.

Adhesive tape

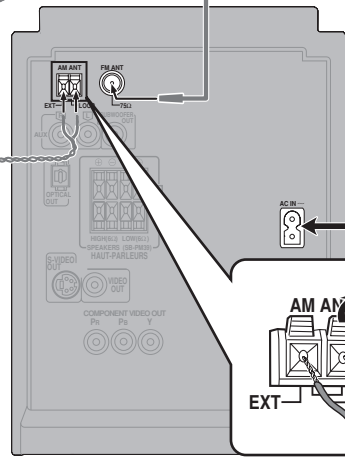

AC power supply cord

To household AC outlet
(AC 120V, 60 Hz)

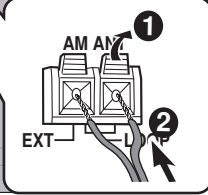

STEP 5

The remote control

Remote control



Batteries

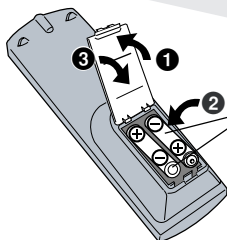

R6/LR6, AA, UM-3

- Insert so the poles (+ and -) match those in the remote control.
- Do not use rechargeable type batteries.

Do not:

- mix old and new batteries.
- use different types at the same time.
- heat or expose to flame.
- take apart or short circuit.
- attempt to recharge alkaline or manganese batteries.
- use batteries if the covering has been peeled off.

Mishandling of batteries can cause electrolyte leakage which can damage items the fluid contacts and may cause a fire.

Remove if the remote control is not going to be used for a long period of time. Store batteries in a cool, dark place.





Use

Aim at the sensor, avoiding obstacles, at a maximum range of 7 m (23 feet) directly in front of the unit.

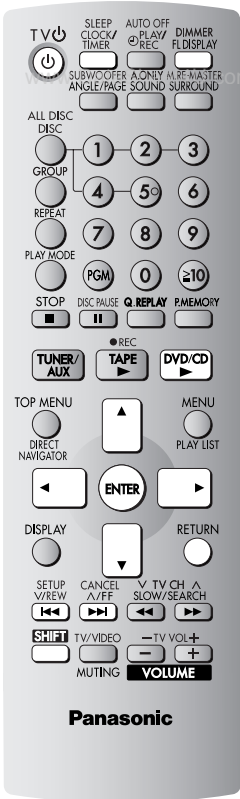

STEP 6 QUICK SETUP

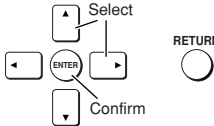
Turn on the television and select the appropriate video input on the television to suit the connection for the unit.

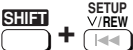

 1 Power ON.	 2 Select "DVD/CD".	 3 Shows QUICK SETUP screen.
 4 Select the option from the screen.	 5 Press to finish QUICK SETUP.	 6 Press to exit.

STEP 7 Setting the time

 1 Select "CLOCK".	 2 Set the time (press within 6 seconds or so).
3 Press [CLOCK/TIMER] to finish setting the time.	

This is a 12-hour clock.

- The time is shown for about 5 seconds when you select "CLOCK" again. Pressing [FL DISPLAY] when the unit is on will also display the time.
- Reset the clock regularly to maintain accuracy.

DEMO function

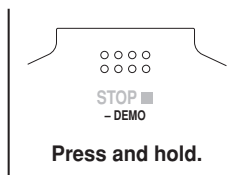
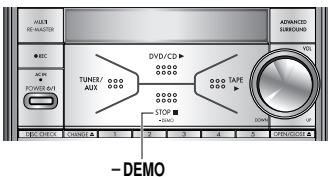

When the unit is first plugged in, a demonstration of its functions may be shown on the display. If the demo setting is off, you can see a demonstration by turning on the demo.

The display changes each time the button is held down.
Demonstration (demo on) ↔ NO DEMO (off)

You can reduce the power consumed in standby mode by turning the demonstration off.

Note

You cannot turn the demo function on and off when the unit is on.

Main unit

Getting started

www.DataSheet4U.com

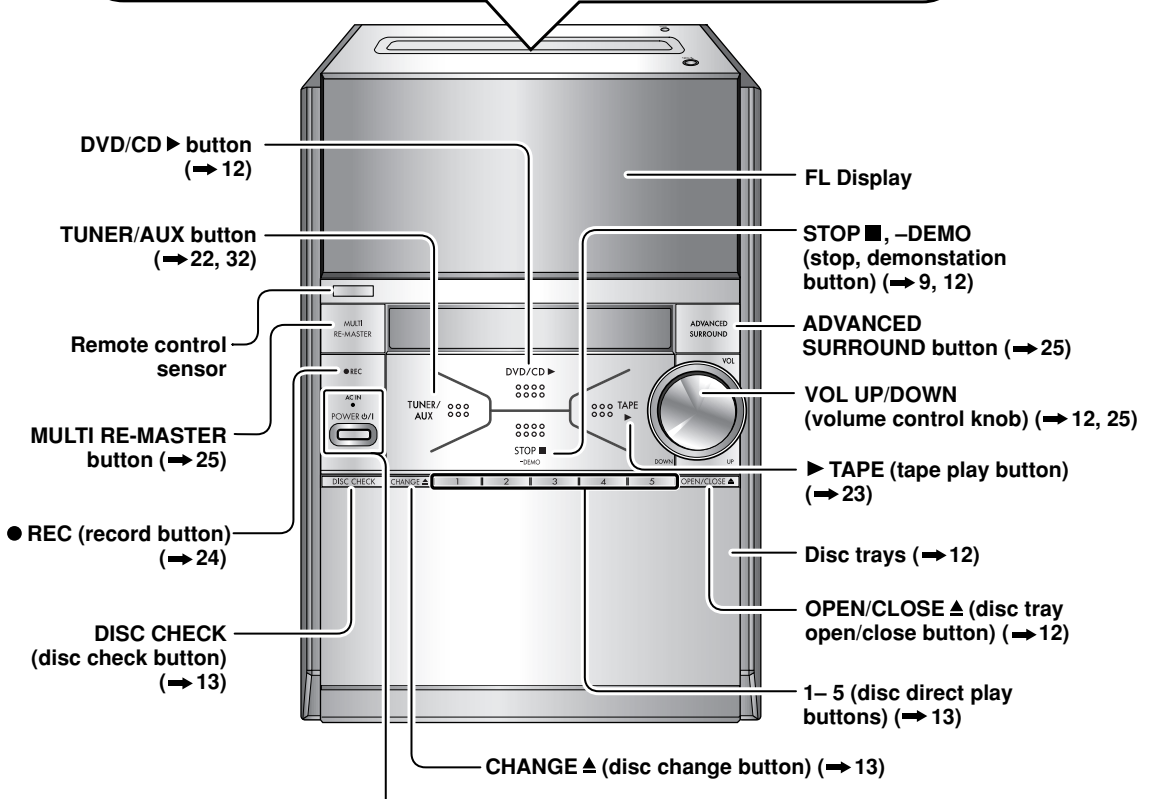
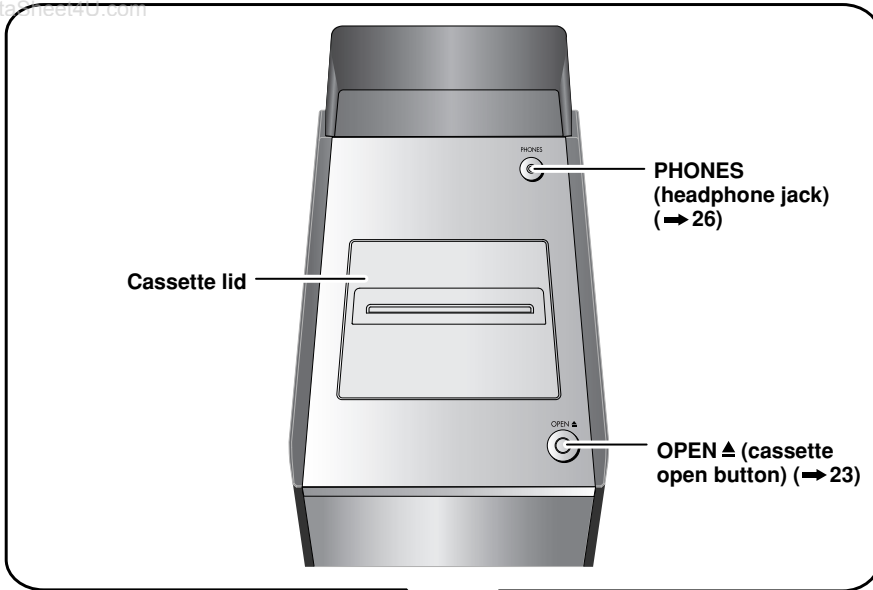

AC IN (AC supply indicator)

This indicator lights when the unit is connected to the AC power supply.

POWER ○/I (standby/on switch)

Press to switch the unit from on to standby mode or vice versa.

In standby mode, the unit is still consuming a small amount of power.

Remote control

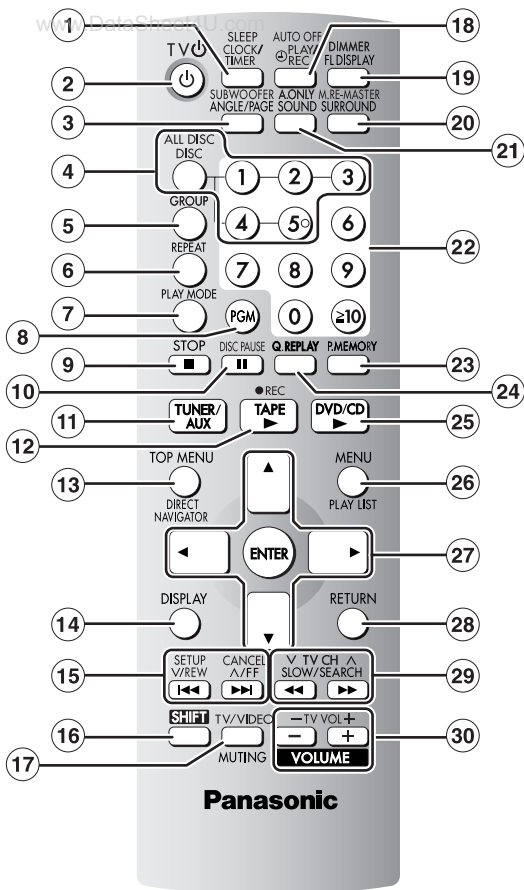

- ① Clock/timer, Sleep timer button [CLOCK/TIMER, SLEEP] 9, 28
- ② Standby/on, TV standby/on switch [⏻, TV⏻] 9, 28
- ③ Angle/Page, Subwoofer button [ANGLE/PAGE, SUBWOOFER] 12, 15, 26
- ④ Disc select, All disc button [DISC, ALL DISC], Disc buttons [1–5] 13
- ⑤ Group button [GROUP] 13
- ⑥ Repeat button [REPEAT] 14
- ⑦ Play mode select button [PLAY MODE] ... 15, 22
- ⑧ Program button [PGM] 15
- ⑨ Stop button [■ STOP] 12

- ⑩ Disc pause button [II DISC PAUSE] 12
- ⑪ Tuner/Aux button [TUNER/AUX] 22, 32
- ⑫ Tape play, Record button [▶ TAPE, ● REC] 23, 24
- ⑬ Top menu, Direct navigator button [TOP MENU, DIRECT NAVIGATOR] ... 13, 17, 18
- ⑭ Display button [DISPLAY] 14, 16, 17, 21
- ⑮ Disc skip, tape fast-forward/rewind, preset channel select, time adjust, Setup, Cancel buttons [◀◀ ▶▶, √/REW, ^/FF, SETUP, CANCEL] 9, 12, 13, 15, 22, 23
- ⑯ Shift button [SHIFT] To use functions labeled in orange: While pressing [SHIFT], press the corresponding button.
- ⑰ Muting, TV/VIDEO button [MUTING, TV/VIDEO] 26, 28
- ⑱ Play timer/record timer, Auto off button [⌚ PLAY/REC, AUTO OFF] 26, 27
- ⑲ FL display, Dimmer button [FL DISPLAY, DIMMER] 9, 26
- ⑳ Surround, Multi re-master button [SURROUND, M.RE-MASTER] 25
- ㉑ Sound, Audio only button [SOUND, A.ONLY] 25
- ㉒ Numbered buttons [0 – 9, ≥10] 13
- ㉓ Position memory button [P.MEMORY] 14
- ㉔ Quick replay button [Q.REPLAY] 15
- ㉕ DVD/CD play button [▶ DVD/CD] 12
- ㉖ Menu, Playlist button [MENU, PLAY LIST] 13, 16–18
- ㉗ Cursor buttons [▲, ▼, ◀, ▶], Enter button [ENTER] 9
- ㉘ Return button [RETURN] 9, 13, 19
- ㉙ Slow/search, tuning, character skip buttons [◀◀, ▶▶ SLOW/SEARCH] 12, 16, 22 These buttons also have the following functions. [◀◀, ▶▶]: TV channel select buttons [TV CH √, ^] 28
- ⑳ Volume buttons [–, +, VOLUME] 12, 25 These buttons also have the following functions. [–, +]: TV volume buttons [TV VOL –, +] 28

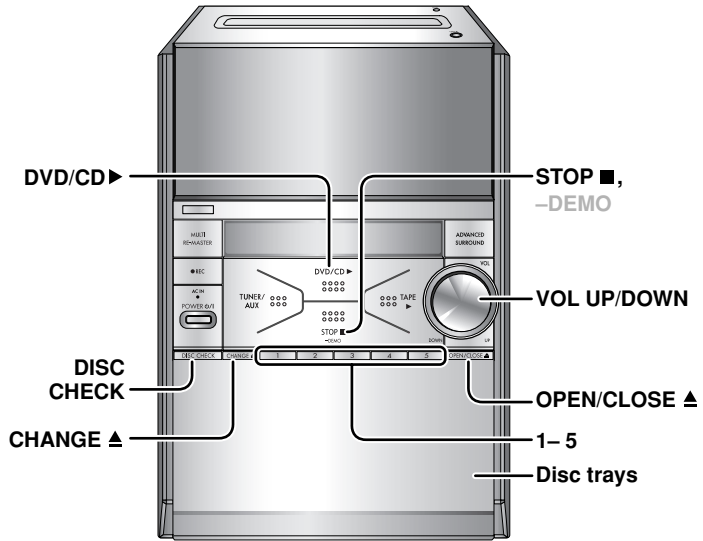

- If the disc contains both audio data (WMA and MP3) and JPEG, select "Audio" to play WMA/MP3, "Picture" to play JPEG or "All" to play both audio and picture while the menu is displayed (except JPEG files on RAM disc). You can also access the menu by pressing [TOP MENU].

<p>1 Open the disc tray.</p> <ul style="list-style-type: none"> • The unit turns on automatically and a tray opens. 	<p>2 Place disc.</p> <p>Label must face upward.</p> <p>Disc tray Tray number</p> <ul style="list-style-type: none"> • Load double-sided discs so the label for the side you want to play is facing up. (→ page 37, Tray/disc handling procedure) 	<p>4 Start play.</p>
--	--	------------------------------------

<p>Volume adjustment</p> <p>VOLUME</p>	<p>Skip</p> <p>(Group skip WMA MP3 JPEG)</p> <p>Select</p> <p>Confirm</p>	<p>Stop</p> <p>STOP</p> <p>The stopped play position is memorized when "RESUME" is displayed.</p> <ul style="list-style-type: none"> • Press DVD/CD to resume. DVD-V To review the previous chapters (→ page 14, Position memory). • Press STOP to clear the position. 	<p>Page skip (during play or pause)</p> <p>ANGLE/PAGE</p> <p>DVD-A</p> <ul style="list-style-type: none"> • To select still pictures.
<p>Pause</p> <p>DISC PAUSE</p> <ul style="list-style-type: none"> • Press DVD/CD to restart play. 	<p>Search (during play)</p> <p>SLOW/SEARCH</p>	<p>Slow-motion (during pause)</p> <ul style="list-style-type: none"> • Up to 5 steps. • Press DVD/CD to restart play. • DVD-A Motion picture parts only. • VCD Slow motion, forward direction only. 	

Frame-by-frame
(during pause)

- **DVD-A** Motion picture parts only.
- **VCD** forward direction only.
- Pressing [DISC PAUSE] also activates forward direction.

Selecting a group

DVD-A WMA MP3 JPEG

On-screen item select

All disc playback
(during stop)

SHIFT + **ALL DISC DISC**

- ALL DISC ON ↔ ALL DISC OFF
- DVD discs and JPEG tracks are skipped.
- HighMAT menus and video CD playback control are disabled.
- The mode cannot be changed during program or random play.

Enter number

RAM DVD-A DVD-V VCD CD

Example: To select 12:
[≥10] → [1] → [2]

VCD with playback control

- Press [STOP] then press the numbered buttons.

WMA MP3 JPEG

Example: To select 123:
[1] → [2] → [3] → [ENTER]

- Press [SHIFT]+[CANCEL] to cancel the number(s).

SHIFT + **CANCEL**

Changing a disc in the desired tray

CHANGE → [1] [2] [3] [4] [5]

Press again to close the tray.

- You can also remove a disc while another is playing (except in all-disc random, program play or during recording).

Disc menu

TOP MENU **DVD-A DVD-V**
Shows a disc top menu

MENU **DVD-V**
Shows a disc menu

RETURN **VCD**
Shows a disc menu

Return to previous screen

RETURN

Selecting the disc

ALL DISC DISC

Checking the disc location

DISC CHECK

Press again to close the tray.

- This feature lets you check whether a 12 cm disc is in a tray.
- If a disc is being played, the corresponding tray will not open.
- Do not remove or insert discs during a disc check.
- Do not pull out the trays during a disc check.

- It may take some time for play to start but this is normal.
- Multiple-channel signals are down-mixed to stereo (2-channel). (⇒ page 32, To enjoy multi-channel surround sound)
- **When playing VCDs with playback control (PBC)**
Pressing buttons to perform skip, search or slow-motion may take you to a menu screen.

- Lights when a Dolby Digital or DTS disc is played.



Discs — Convenient functions

www.DataSheet4U.com

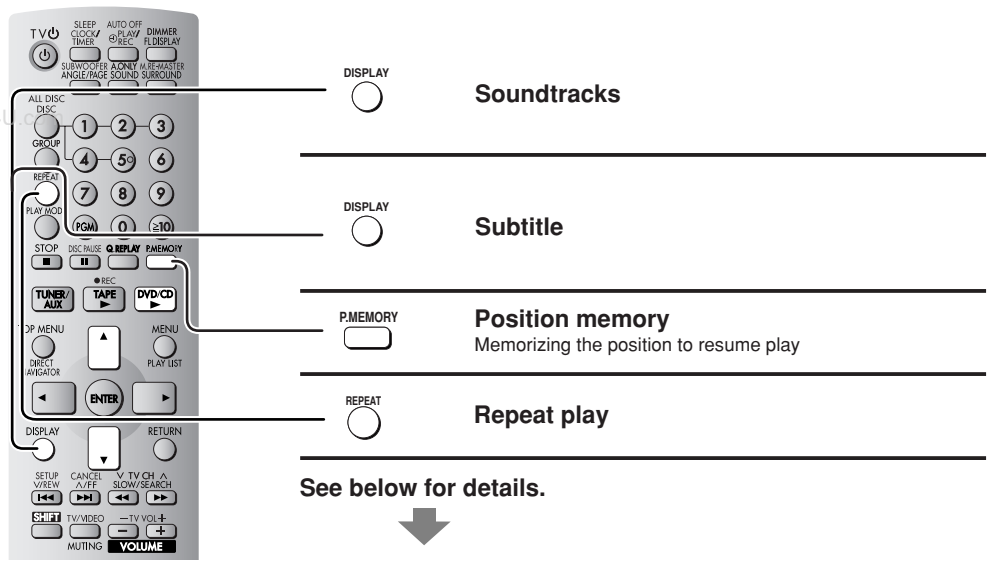

Disc operations

Soundtracks

RAM DVD-A DVD-V VCD

(Discs with multiple soundtracks)

During play

Press **[DISPLAY]** then **[▼, ▲]** to select "Audio" (soundtrack).

(⇒ page 19, Audio)

Subtitle

DVD-A (Motion picture parts only)

DVD-V (Discs with multiple subtitle languages) **VCD** (SVCD only)

During play

Press **[DISPLAY]** to select the subtitle language. (⇒ page 19, Subtitle)

RAM

You can only switch the subtitles on or off (⇒ page 19, Subtitle).

To change the subtitle position and brightness (⇒ page 21, Display Menu)

Position memory

(Only when the elapsed play time can be displayed)

JPEG: Works with all JPEG contents.)

This position is memorized even after switching off the unit or changing the disc.

During play

Press **[P.MEMORY]**.

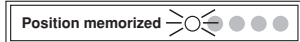

- Up to 5 discs.
- When the sixth disc is memorized, the earliest position is replaced.
- After changing the source or selecting another disc, re-selecting the disc tray with the memorized position automatically starts playback.

When the unit is switched on in "DVD/CD" mode or reinsert the disc whose position you memorized, "RESUME" lights on the display.

Press **[▶ DVD/CD]** to start play from that position.

To review the previous chapters DVD-V

Press **[▶ DVD/CD]** while the following message is on the display.

Press **PLAY** to preview chapters

- Do not press **[▶ DVD/CD]** if you want to cancel review.

Soundtracks

Subtitle

Position memory

Memorizing the position to resume play

Repeat play

See below for details.



Repeat play

(Only when the elapsed play time can be displayed)

JPEG: Works with all JPEG contents.)

During play

Press **[REPEAT]** to select an item to be repeated.

For 1-disc play

RAM

PG REPEAT^{#1} → ALL REPEAT (Entire Disc) → REPEAT OFF

• During play list play

SCENE REPEAT → PL REPEAT^{#2} → REPEAT OFF

DVD-V

CHAPTER REPEAT → TITLE REPEAT^{#3} → REPEAT OFF

VCD CD

TRACK REPEAT → ALL REPEAT (Entire disc) → REPEAT OFF

DVD-A

TRACK REPEAT → GROUP REPEAT^{#3} → REPEAT OFF

WMA MP3

CONTENT REPEAT → GROUP REPEAT^{#3} → REPEAT OFF

JPEG

GROUP REPEAT^{#3} → REPEAT OFF

- You can also repeat play of content and group on HighMAT discs.

For All-disc play (⇒ page 13)

VCD CD WMA MP3

ALL DISC RPT^{#4} → REPEAT OFF

To repeat only your favorite tracks, contents or chapters

Start program play (⇒ page 15, Program play (up to 24 items)) and press **[REPEAT]** to select the repeat mode.

^{#1} Program repeat (⇒ page 18, Playing the programs on DVD-RAM).

^{#2} Playlist repeat (⇒ page 18, Using the play list on DVD-RAM).

^{#3} **During all group (DVD-A), program and random play**

"ALL REPEAT" is displayed.

^{#4} All-disc repeat.

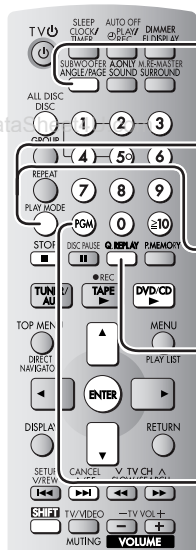

SUBWOOFER ANGLE/PAGE

Angles

DVD-V (with multiple angles) – Angle select

JPEG – Still picture rotation
(During play)

PLAY MODE

All group play

Plays tracks in all the groups on a disc.
(During stop) **DVD-A**

PLAY MODE

Random play

Quick replay

(Only when the elapsed play time can be displayed)
(During play) **RAM DVD-A DVD-V VCD**
CD WMA MP3
To skip back a few seconds.

PGM

Program play

See below for details.



Random play

VCD CD (There is no on-screen display)

1-disc random: All the items on a disc in random order.

All-disc random: All the items on all the discs in random order.

DVD-A DVD-V WMA MP3 JPEG

1-disc random only: Selected items on a disc in random order.

During stop

1 Press **[PLAY MODE]** until the **RANDOM** screen appears.

2 (**DVD-A DVD-V WMA MP3 JPEG**)

Press the numbered buttons to select a group (**WMA MP3 JPEG**) then press **[ENTER]** or a title.

Example **DVD-V**

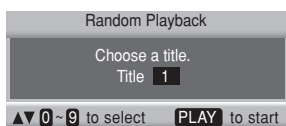

DVD-A

- You can select more than one group or all groups.
- To deselect a group, select the group again.

3 Press **[▶ DVD/CD]**.

Note

- During random play, empty trays are skipped and the playback control function on Video CDs is cancelled.
- During random play, this unit can access up to 999 audio or picture contents and 400 groups.

Program play (up to 24 items)

VCD CD (There is no on-screen display)

DVD-A DVD-V WMA MP3 JPEG

Example: **DVD-V**

During stop

1 **VCD CD**
Press **[DISC]** and then disc button (**[1] – [5]**).
Press **[STOP]**.

2 Press **[PGM]**.
“PGM” appears.

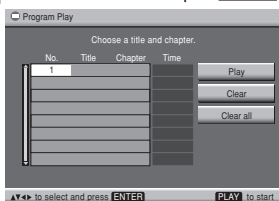

3 Press the numbered buttons to select the items (**WMA MP3 JPEG**) then press **[ENTER]**.

- Repeat this step to program other items.
- VCD CD** Step 1 is unnecessary when programming tracks on the same disc.
- DVD-A DVD-V WMA MP3 JPEG**

To select an item using the cursor buttons

Press **[ENTER]** and **[▲ ▼]** to select an item, then press **[ENTER]** again to confirm the number.

All the items on the disc, title or group are selected when you select “ALL”.

4 Press **[▶ DVD/CD]** to play.

- DVD-A DVD-V WMA MP3 JPEG**

To add to or change the program

Press **[▲ ▼]** to select an available item, then repeat step 3.

To clear the whole program

Select “Clear all” and press **[ENTER]**.

To clear an item

Press **[SHIFT]+[CANCEL]**, or select “Clear” and press **[ENTER]**.

- Press **[ANGLE/PAGE]** to skip 8 lines at a time.

Note

- Clear the existing program before creating a new program.
- DVD-V WMA MP3 JPEG**
Times are not displayed while programming.
- VCD CD**
Items the unit cannot find can be programmed but are cancelled during play. This is also the case if you program the discs other than Video CD and CD.
- The program is cleared when you switch the unit to standby, select another source, exit the program mode or move the disc out of the play position.

VCD CD

The program is retained in memory.

Note

- DVD-A** If you select bonus groups, you will have to enter a password.
- Disable HighMAT disc play (→ page 30, “Others” tab) to use random and program play.
- Quick replay feature may not work while playing some parts of a disc or at all with some discs.

Discs — Using navigation menus

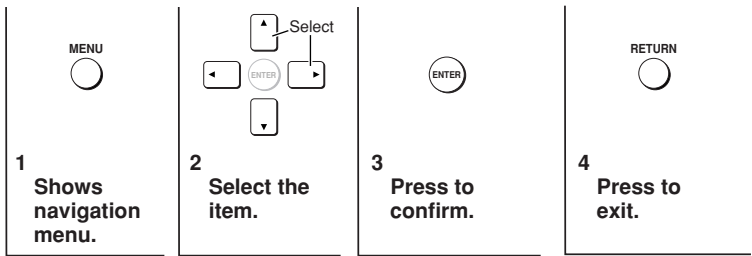

Example: **WMA MP3** (Navigation menu)



Example: **JPEG** (Thumbnails)

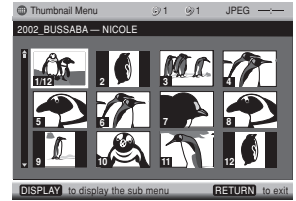

Search methods



Using the tree screen to find a group **WMA MP3 JPEG**

- While the navigation menu is displayed, press **[DISPLAY]**.
- Press **[▼]** to select "Tree" and press **[ENTER]**.
- Press **[▲, ▼]** to select a group and press **[ENTER]**.
The navigation menu for the group appears.

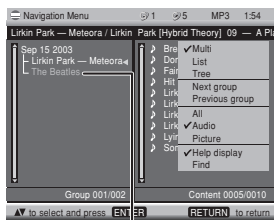

Indicates this group includes non compatible files

Using the submenu **WMA MP3 JPEG**

While the navigation menu is displayed, press **[DISPLAY]**.

Multi	Groups and contents
List	Contents only
✓ Tree	Groups only
Thumbnail	Thumbnail images JPEG
Next group	To go to next groups WMA MP3
Previous group	To go to previous groups WMA MP3
All	WMA/MP3 and JPEG files
✓ Audio	WMA/MP3 files only
Picture	JPEG files only
✓ Help display	To switch between guide messages and the elapsed play time indicator
Find	To search by content or group title

Using a contents screen to find a track **CD** (CD text only)

While the menu is displayed
Press **[▲, ▼]** to move through the tracks and press **[ENTER]**.

- Press **[ANGLE/PAGE]** to skip 10 lines at a time.



Searching by content or group title **WMA MP3 JPEG**

Place the cursor on the group title to search a group, or place the cursor on the content title to search contents.

- Select "Find" (→ see above).
- Press **[▲, ▼]** to select a character and press **[ENTER]**.
 - Repeat to enter other characters.
 - Lower case is also searched.
 - Press **[◀, ▶]** to skip between A, E, I, O, and U.
 - Press **[←]** to erase a character.
 - Erase the asterisk (*) to search only for the titles starting with that word.
- Press **[▶]** to select "Find" and press **[ENTER]**.
The search results screen appears.
- Press **[▲, ▼]** to select the content or group and press **[ENTER]**.

Tips for making WMA/MP3, CD text and JPEG discs

- Discs must conform to ISO9660 level 1 or 2 (except for extended formats).
- This unit is compatible with multi-session but if there are a lot of sessions it takes more time for play to start. Keep the number of sessions to a minimum to avoid this.
- The order in which the tracks appear in the menus may differ from the order shown on your computer.

Naming folders and files

At the time of recording, prefix folder and file names with 3-digit numbers in the order you want to play them (this may not work at times).

Files must have the extension:

“.WMA” or “.wma”

“.MP3” or “.mp3”

“.JPG”, “.jpg”, “.JPEG” or “.jpeg”

WMA

- Noise may occur when playing WMA files.
- You cannot play WMA files that are copy protected.

MP3

- This unit is not compatible with ID3 tags.
- If you play an MP3 track that includes still picture data, it will take some time before the music itself starts playing and the elapsed time will not be displayed during this time. Even after the track starts, the correct play time will not be displayed.

JPEG

- To view JPEG files on this unit:
 - Take them on a digital camera that meets the DCF (Design rule for Camera File System) standard. Some digital cameras have functions that are not supported by the DCF standard like automatic picture rotation which may render a picture unviewable.
 - Do not alter the files in any way or save them under a different name.
- This unit cannot display moving pictures, Motion JPEG and other such formats, still pictures other than JPEG (i.e. TIFF) or play associated sound.

CD (CD text only)

When making your own CD text discs

The unit plays the tracks in the order you record them so you do not have to prefix the titles with numbers.

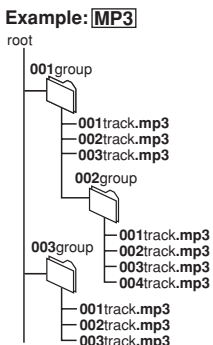

Playing HighMAT discs **WMA MP3 JPEG**

A menu appears when you select the disc.

Press [**▲**, **▼**, **◀**, **▶**] to select then press [ENTER].

When you press [ENTER]:



Menu: Takes you to the next menu which shows play lists or another menu.



Play list: Play starts.

- **To display the screen**
Press [TOP MENU].
- **To return to the menu above the current one**
Press [RETURN].
- **To change the menu background**
Press [DISPLAY].
The background changes to the one recorded on the disc.
- **To exit the screen**
Press [■ STOP].

Selecting from the lists

1 During play

Press [MENU].

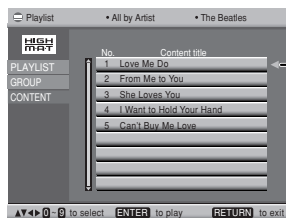

2 Press [**◀**] then [**▲**, **▼**] to switch between the play list, group and content lists.

3 Press [**▶**] then [**▲**, **▼**] to select an item and press [ENTER].

- Press [ANGLE/PAGE] to skip 10 lines at a time.
- **To exit the list screen**
Press [MENU].



HighMAT and the HighMAT logo are either trademarks or registered trademarks of Microsoft Corporation in the United States and/or other countries.

Windows Media, and the Windows logo are trademarks, or registered trademarks of Microsoft Corporation in the United States and/or other countries.



WMA is a compression format developed by Microsoft Corporation. It achieves the same sound quality as MP3 with a file size that is smaller than that of MP3.

MPEG Layer-3 audio decoding technology licensed from Fraunhofer IIS and Thomson multimedia.

Playing programs on DVD-RAM

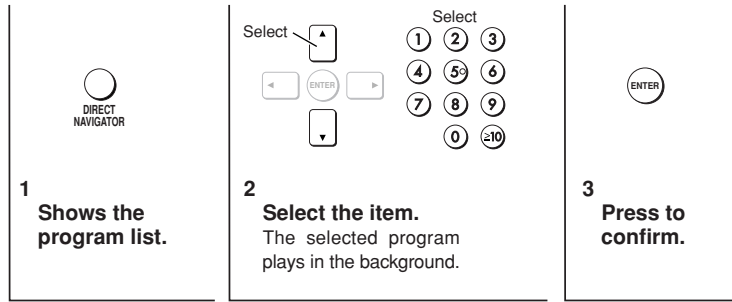

- Titles appear only if you have entered them.
- You cannot change program and disc titles.
- Press [▶] to show the contents of the program.
- Press [ANGLE/PAGE] to skip 5 lines at a time.

Indication on the unit's display.
PG: Program number

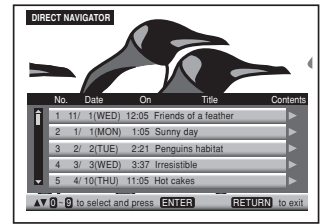

Disc operations

Using the play list on DVD-RAM

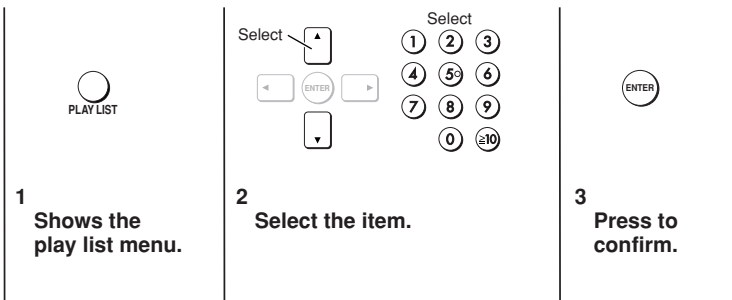

You can play a group of scenes and a play list created on other equipment such as a DVD video recorder.

- The play list can be selected only if the disc contains a play list.
- Press [ANGLE/PAGE] to skip 10 lines at a time.

Indication on the unit's display.
PL: Play list number



Discs — Using On-screen menu

To get disc information or to play from a specified item

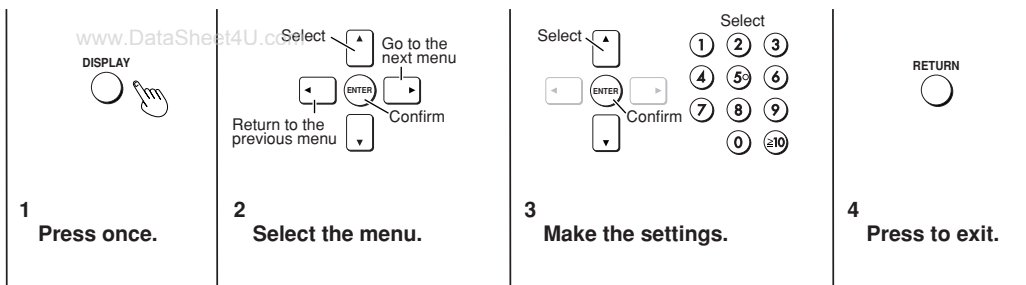

Items shown differ depending on the type of software.

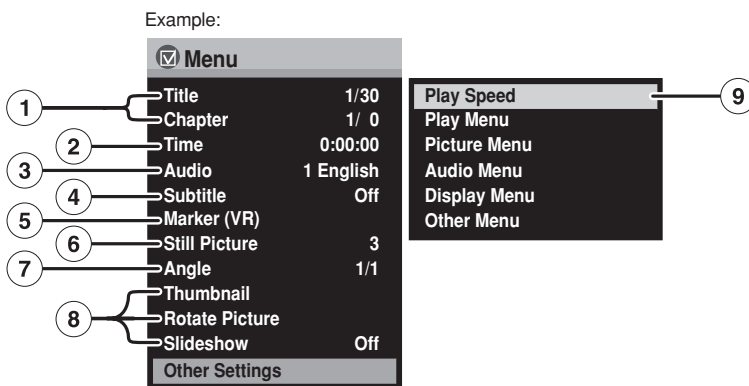

①	<p>Program, Group, Title, Track, Chapter, Playlist, Content To start from a specific item.</p>
②	<p>Time Time Slip (during play) RAM DVD-A DVD-V To skip the time forward or backward. 1. Press [ENTER] twice to show Time Slip indicator. 2. Press [▲, ▼] to enter the time and press [ENTER]. • Press and hold [▲, ▼] to alter faster.</p> <p>Time Search RAM DVD-A DVD-V To start from a specific time.</p> <p>Elapsed/Remaining Time RAM DVD-A DVD-V VCD CD To change between elapsed or remaining time display.</p>
③	<p>Audio (Discs with multiple soundtracks) DVD-A Play restarts from the beginning of the soundtrack when changing soundtracks that are accompanied by still pictures.</p> <p>DVD-V (Karaoke discs) You can also use this button to switch the vocals on and off. Read the disc's instructions for details.</p> <p>Karaoke vocals, on and off</p> <p>Solo : On ↔ Off Duet : Off ↔ V1 ↔ V2 ↔ V1+V2</p> <p>RAM VCD You can also use this button to select "L", "R" or "L R".</p> <p>Audio attributes See A → page 21, Audio attributes.</p>

④	<p>Subtitle DVD-A (Motion picture parts only) DVD-V (Discs with multiple subtitle languages) VCD (SVCD only)</p> <p>To clear or display the subtitles Press [▲, ▼] to select "On" or "Off".</p> <p>Subtitle on or off RAM</p>
⑤	<p>Marker (VR) RAM To recall a marker recorded on DVD-Video recorders.</p>
⑥	<p>Still Picture DVD-A To view still pictures.</p>
⑦	<p>Angle DVD-V (Discs with multiple angles) To select the angle. (→ page 15, Angles)</p>
⑧	<p>Thumbnail JPEG To show thumbnail images.</p> <p>Rotate Picture JPEG (→ page 15, Angles)</p> <p>Slideshow JPEG To turn the slideshow on or off. To change the timing (0–30 seconds) of the slideshow.</p>
⑨	<p>Other Settings—Play Speed RAM DVD-A (Motion picture parts only) DVD-V</p> <p>To change play speed – from x0.6 to x1.4 (in 0.1 unit steps)</p> <ul style="list-style-type: none"> • After you change the speed: <ul style="list-style-type: none"> – Digital output switches to PCM-2ch. • Sound is stereo as long as "Normal" is selected.

Example:

<input checked="" type="checkbox"/> Menu	
Title	1/30
Chapter	1/ 0
Time	0:00:00
Audio	1 English
Subtitle	Off
Marker (VR)	
Still Picture	3
Angle	1/1
Thumbnail	
Rotate Picture	
Slideshow	Off
Other Settings	

Play Speed	
Play Menu	10
Picture Menu	11
Audio Menu	12
Display Menu	13
Other Menu	14

www.DataSheet4U.com

Play Menu

Repeat (→ page 14, Repeat play)
RAM DVD-A DVD-V
 Except **JPEG** and **RAM** (still picture part).

A-B Repeat
RAM DVD-A DVD-V VCD CD WMA MP3
 Except **RAM** (still picture part).
 Repeat a section between points A and B within an item.
 [ENTER] (start point) → [ENTER] (finish point)
 To cancel: [ENTER]

⑩ • A-B repeat is cancelled when you press [Q.REPLAY].

Marker
DVD-A DVD-V VCD CD WMA MP3 JPEG
 To mark a position to play again (Marker).
 • Press [▶] to highlight the first asterisk and press [ENTER] again to mark a position.
 You can mark up to 5 positions.
 To mark another position: [◀, ▶] → [ENTER]
 To recall a marker: [◀, ▶] → [ENTER]
 To erase a marker: [◀, ▶] → [SHIFT]+[CANCEL]
 • This feature does not work during program and random play.

Picture Menu

Picture Mode
RAM DVD-A DVD-V VCD JPEG
Normal
Cinema1: Mellows images and enhances detail in dark scenes.
Cinema2: Sharpens images and enhances detail in dark scenes.

Animation
Dynamic
User (Press [ENTER] to select "Picture Adjustment")
 (→ see below)

Picture Adjustment
Contrast Brightness Sharpness Color
Gamma (Adjusts the brightness of dark parts.)
Depth Enhancer

⑪ • Reduce the rough noise in the background to give a greater feeling of depth.

Video Output Mode
RAM DVD-A DVD-V VCD JPEG
 To switch between Progressive (480P) and Interlace (480i) video.

Transfer Mode
RAM DVD-A DVD-V VCD
 If you have chosen "480P" (→ see above), select the method of conversion for progressive output to suit the type of material.
Auto1 (normal): For viewing film material
Auto2: For viewing film material (the same as Auto1, but able to convert 30-frame-per-second progressive video)
Video: For video material

Audio Menu

Advanced Surround
RAM DVD-A DVD-V VCD CD WMA MP3
 (2 channels or more)
 Enjoy a surround-like effect when using front speakers or headphones. The effect broadens when playing discs with surround effects and sound seems to come from speakers on either side of you.

- **The level**
 Off (cancel – factory setting)
 Natural
 Enhanced

Optimum seating position

<When using the television's speakers>
 Distance A = Television's width

Speaker ← A → Speaker
 3 to 4 times distance A
 Seating position

⑫ • This does not work or has less effect with some discs.
 • Turn off if it causes distortion.
 • Do not use in combination with surround effects on other equipment.
 (→ page 25, Advanced Surround)

Dialogue Enhancer
DVD-V
(Dolby Digital, DTS, 3-channel or over, where the dialogue is recorded in the center channel)
 This makes the dialogue in movies easier to hear.
 On ↔ Off (Factory preset)

- This does not work or has less effect with some discs.

Multi Re-master
RAM DVD-A DVD-V CD
 For discs recorded with multi-channels LPCM at 44.1 kHz or 48 kHz.
 It adds higher frequency signal not recorded on the discs, which gives a more natural sound effect.

WMA MP3
 For discs recorded at 44.1 kHz or 48 kHz.
 This format reproduces the frequencies lost during recording to give you a sound closer to the original effect.
 (→ page 25, Multi Re-master—Enjoying more natural sound)

Display Menu

Subtitle Position **DVD-V**
0 to -60 in 2 unit steps.

Subtitle Brightness **DVD-V**
"Auto" to automatically adjust the brightness against the background, or 0 to -7.

Information
On → Off
(**JPEG**) : Off, Date, Details.)

4:3 Aspect **RAM DVD-A DVD-V VCD JPEG**
To select how to show images made for 4:3 aspect screens on a 16:9 aspect television.
Normal: Laterally stretches images.
Auto: Expands 4:3 letterbox images to fill more of the screen. Other images appear in full in the center of the screen.
Shrink: Images appear in the center of the screen.
Zoom: Expands all images to fill the screen.
If your television has a similar feature, use it instead for a better effect.

Just Fit Zoom
RAM DVD-A (Motion picture parts only)
DVD-V VCD
Preset zoom ratios suitable for the following video formats are available.

Auto	American Vista	1.85:1
4:3 Standard	Cinemascope1	2.35:1
European Vista	Cinemascope2	2.55:1
16:9 Standard		16:9

Manual Zoom
RAM DVD-A (Motion picture parts only)
DVD-V VCD
Fine adjustments
Press [**▲**, **▼**].
– from x1.00 to x1.60 (in 0.01 units)
– from x1.60 to x2.00 (in 0.02 units)

Bitrate Display
RAM DVD-A (Moving picture parts only) **DVD-V VCD**
When you select "On":
During play: shows the bitrate (approximate values) of the video being played
During pause: shows the data volume of the frame and type of picture (→ page 37, Glossary— I/P/B)

GUI See-through
To enable the on-screen menu to become translucent.

GUI Brightness (-3 to +3)
To adjust the brightness of the on-screen displays.

Other Menu

Play as DVD-Video or Play as DVD-Audio
While stopped
• Select "Play as DVD-Video" to play DVD-Video contents of DVD-Audio.

⑭ **Play as DVD-VR, Play as HighMAT or Play as Data Disc**
While stopped
• Select "Play as Data Disc" to play JPEG files on DVD-RAM or to play HighMAT disc without using the HighMAT function.

A Audio attributes
LPCM/PPCM/□□Digital/DTS: Signal type
kHz: Sampling frequency
bit: Number of bits
channel: Number of channels

Example:
3/2 .1ch
 .1: Low frequency effect (not displayed if there is no signal)
 0: No surround
 1: Mono surround
 2: Stereo surround (left/right)
 1: Center
 2: Front left + Front right
 3: Front left + Front right + Center

To see the playback position

RAM DVD-A DVD-V VCD CD WMA MP3

1 **Press twice.**



2 **Change the playback time display.**

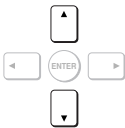

3 **Press to exit.**





Condition – play, pause or slow/search

Current position

Current playback item

Elapsed play time

The radio



Manual tuning

	or	 VOLUME
1 Select "FM" or "AM". FM → AM → AUX 	2 Select the frequency of the desired station.	3 Adjust the volume.

- Press and hold [◀◀] or [▶▶] until the frequency starts scrolling to start automatic tuning. Tuning stops when a station is found.

"ST" is displayed when a stereo FM broadcast is being received.

If noise is excessive in FM

1. Press [PLAY MODE] to display "MONO".
2. Press [PLAY MODE] again to cancel the mode. (The mode is also cancelled when you change the frequency)

Radio operations

■ FM frequency step (main unit only)

The step is factory-set to 0.2 MHz, but you can change it to receive broadcasts allocated to 0.1 MHz steps.

1. Select "FM".
2. Press and hold [TUNER/AUX].
 After a few seconds the display changes to show the current minimum frequency. Continue to hold the button down. The minimum frequency changes and the step is changed.
 To return to the original step, repeat the above steps.

Note

After changing the "allocation" setting, the frequencies you previously preset in the memory will be cleared. Preset them again.

Preset tuning

Preset channels to make selection simpler. Up to 15 stations can each be set in the FM and AM bands.

Manual presetting

Tune to the desired station (→ see above).

	1 2 3 4 5 6 7 8 9 0 10
1 Press to select. ("PGM" will appear.)	2 Press while the station is flashing to select the channel.

The station occupying a channel is erased if another station is preset in that channel.

Automatic presetting

Tune to the frequency where pre-setting is to begin (→ see above).

Press and hold. (release when "AUTO" is displayed.)

The tuner presets all the stations it can receive into the channels in ascending order. When finished, the last station to be set is played.

Selecting channels

1. Press [TUNER/AUX] to select "FM" or "AM".
2. Press the numbered buttons or [◀◀ √/REW] or [▶▶ ∧/FF] to select the channel.

Cassette tapes

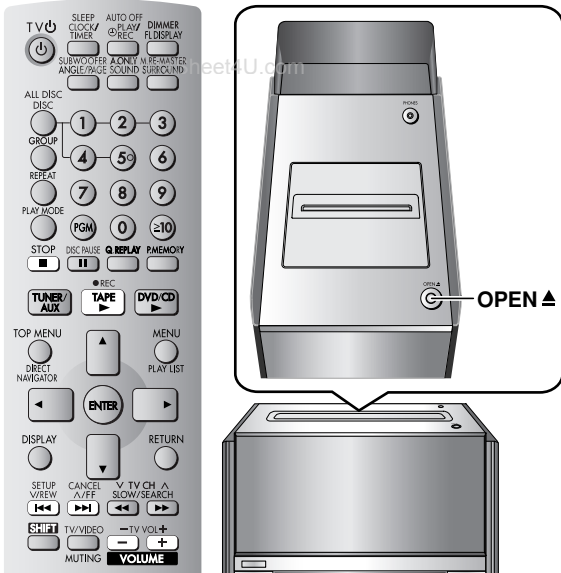

Cassette tape selection and care

Use normal position tapes.

High position and metal position tapes can be played, but the unit is not able to do full justice to the characteristics of these tapes.

- Tapes exceeding 100 minutes are thin and can break or get caught in the mechanism.
- Tape slack can get caught up in the mechanism and should be wound up before the tape is played.
- Endless tapes can get caught up in the deck's moving parts if used incorrectly.

A Insert cassette

Side to be played back facing up.

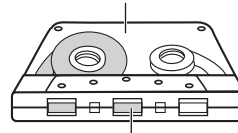

Insert the cassette with the exposed tape facing you.



- 1 **Press to open and insert a cassette**
(tape facing you, see **A** – make sure that the cassette is fully inserted and close the lid by hand).



- 2 **Start play.**
 - To play the other side of the tape, turn the tape over and restart play.



To fast-forward or rewind the tape

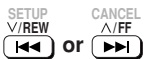

To fast-forward ([▶▶] ^/FF)
or rewind ([◀◀] V/REW)
(during stop).

To find the beginning of a program (TPS: Tape Program Sensor)

TPS finds the beginning of a track and resumes play from there. Each press increases the number of tracks skipped, up to a maximum of 9.



TPS function search
(during play).

The TPS function searches for silent parts of about 4 seconds in length which are normally found between tunes. As a result, it may not function properly in the following cases.

- With short silent parts
- When noise occurs between tunes
- With silent parts found within tunes

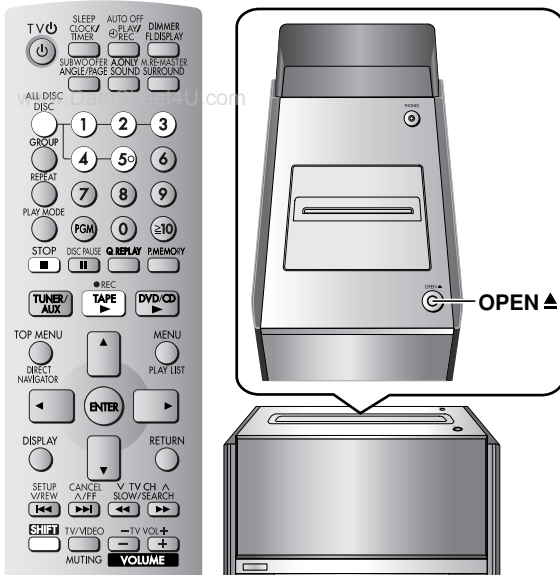

Types of tape which can be recorded correctly

Use normal position tapes.

High position and metal position tapes can be used, but the unit is not able to record or erase them correctly.

Preparatory steps

Do these steps before each recording.

Wind up the leader tape so recording can begin immediately.



Press to open and insert a cassette

Tape facing you (see **A** → page 23, Insert cassette) – make sure that the cassette is fully inserted and close the lid by hand.

Volume, surround effects, sound field and quality

- Recording level is set automatically.
- The volume, sound field and quality have no effect on recording. They can be adjusted for playback.
- Multi-channel sources are automatically down-mixed to 2 channels during recording.

Recording from disc(s)

- Do the preparatory steps (→ see above).
- Insert the disc(s) you want to record (→ page 12, Discs—Basic play).

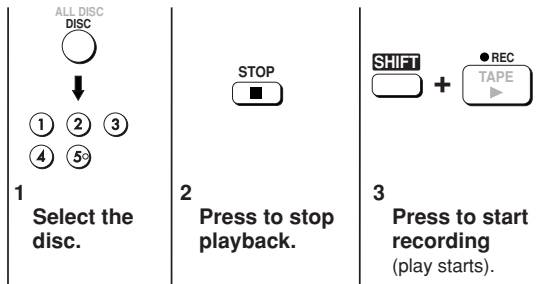

- When recording stops, disc play stops automatically.

Recording specific disc(s) or tracks.

- Do the preparatory steps (→ see above).

- 1 Do steps 1 to 2 (→ see above, Recording from disc(s)).
To record programmed tracks
 - Do steps 1 to 3 (→ page 15, Program play (up to 24 items)).
- 2 Press [SHIFT] + [●REC] (main unit: [●REC]) to start recording.

If the tape finishes before the disc

The disc continues playing. Stop it by pressing [■ STOP].

Recording from the radio

- Do the preparatory steps (→ see above).

- 1 Tune to the desired station (→ page 22, The radio).
 - 2 Press [SHIFT] + [●REC] (main unit: [●REC]) to start recording.
- When recording an AM broadcast, sound is momentarily interrupted when you start and stop the recording.

To stop recording

Press [■ STOP].

- To record or erase the other side, turn the tape over.

Note

During recording, other buttons will not function except for [■ STOP], [MUTING], [-, +, VOLUME], [|| DISC PAUSE], [⏪] and [OPEN/CLOSE ▶].

Recording from an external unit

- Do the preparatory steps. (→ see above)
(For connections → page 32, Using an external unit)

- 1 Do step 1 (→ page 32, Using an external unit—To playback).
- 2 Press [SHIFT] + [●REC] (main unit: [●REC]) to start recording.
- 3 Start playback from the external source.
(For details, refer to the external unit's instruction manual.)

Erasure prevention

Use a screwdriver or similar object to break out the tab.

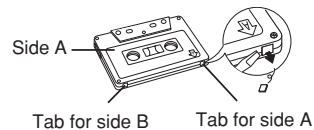

To record on the tape again, cover the hole with adhesive tape.

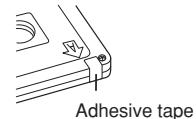

Erase recordings

1. Press [▶ TAPE] and then [■ STOP].
2. Press [SHIFT]+[●REC] (main unit: [●REC]).

Sound field and sound quality

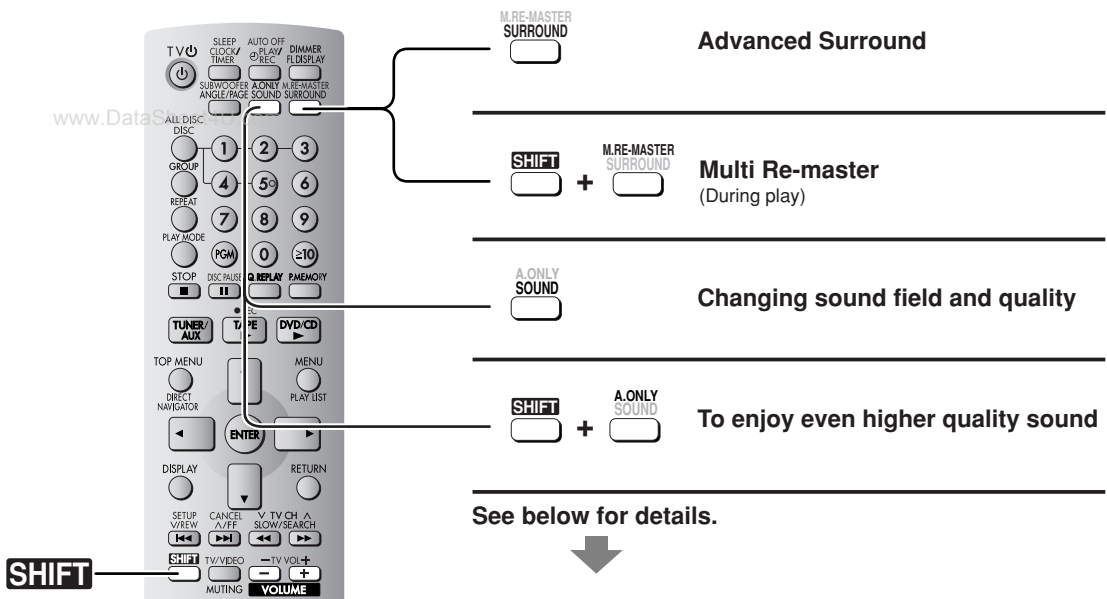

See below for details.

Advanced Surround

Press [SURROUND] (main unit: [ADVANCED SURROUND]).



Every time you press the button:

- ADV SURR 1: Natural effect
- ↓
- ADV SURR 2: Enhanced effect
- ↓
- SURR OFF: Cancel (factory preset)

(→ page 20, Audio Menu)

Multi Re-master — Enjoying more natural sound

RAM DVD-A DVD-V CD

Discs recorded with multi channels LPCM at 44.1 kHz or 48 kHz
This feature gives you a more natural sound by adding the higher frequency signals not recorded on the disc.

WMA MP3

Discs recorded at 44.1 kHz or 48 kHz

This feature reproduces the frequencies lost during recording to give you a sound closer to the original.

During play

Every time you press [SHIFT]+[M.RE-MASTER]
(main unit: [MULTI RE-MASTER]):

Setting	RAM DVD-A DVD-V CD	WMA MP3
	Type of music	Effect level
1	High tempo (e.g., pops and rock)	Light
2	Various tempos (e.g., jazz)	Medium
3	Low tempo (e.g., classical)	Strong
Off	Off	Off

Note

The actual output sampling frequency depends on the PCM Digital Output setting (→ page 31, PCM Digital Output) when using a digital connection (→ page 32, Home Theater — Enjoying more powerful sound).

Changing sound field and quality

Preset EQ

1 Press and hold [SOUND] to select “PRESET EQ”.

Every time you press and hold the button:
MANUAL EQ ↔ PRESET EQ

2 Press [SOUND] to select a setting.

Every time you press the button:

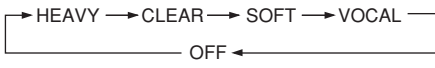

- HEAVY: Adds punch to rock
- CLEAR: Clarifies higher sounds
- SOFT: For background music
- VOCAL: Adds gloss to vocal

Manual EQ

1 Press and hold [SOUND] to select “MANUAL EQ”.

Every time you press and hold the button:
MANUAL EQ ↔ PRESET EQ

2 Press [SOUND] to select a setting.

Every time you press the button:

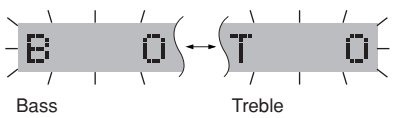

3 Press [–, +, VOLUME] while either “B” (Bass) or “T” (Treble) is flashing to change the level.

To enjoy even higher quality sound—AUDIO ONLY

You can enjoy higher quality audio by stopping the video output.

During play

Press [SHIFT] + [A.ONLY].

- AUDIO ONLY is cancelled if you press [SHIFT]+[A.ONLY] again or switch the unit to standby.
- There is output to the screen only when:
 - the disc is stopped.
 - performing operations such as searching.
 - on screen display is displayed.

Sound field and sound quality operations

Note

The feature may not work depending on the discs' recording.

Convenient functions

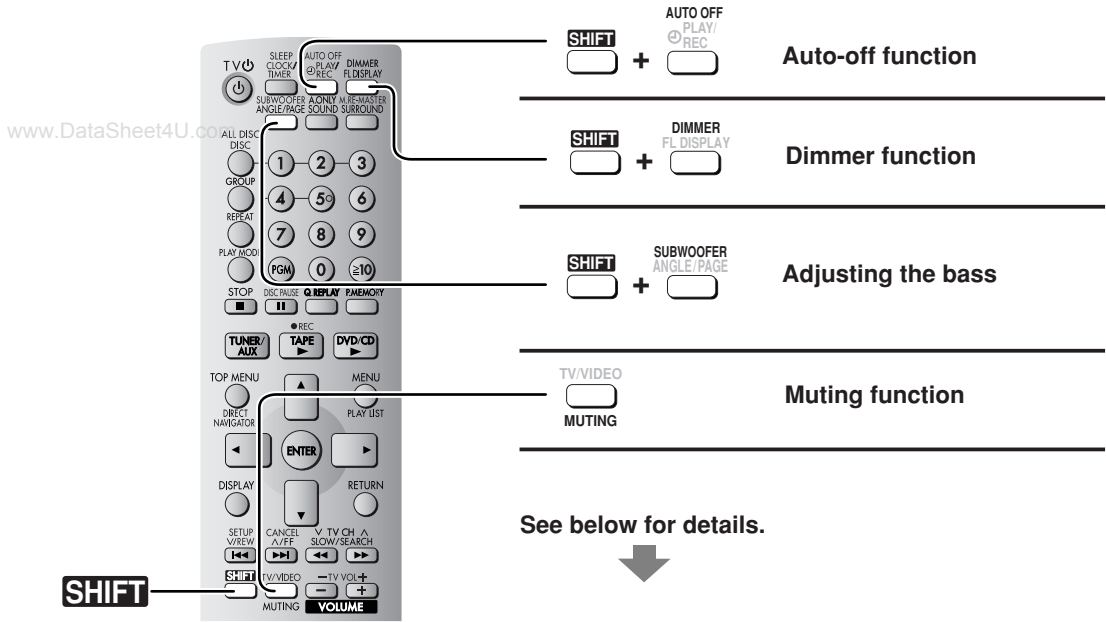

See below for details.



Auto-off function

When disc or tape is selected as the source
To save power, the unit turns off if it is left unused for 10 minutes.

Press **[SHIFT]** + **[AUTO OFF]**.
"A.OFF" is shown on the display.
This function does not work if the source is tuner or AUX.

To cancel
Press **[SHIFT]**+**[AUTO OFF]** again to clear "A.OFF" from the display.

For your reference
"A.OFF" disappears from the display but continues to function normally if either tuner or AUX is selected as the source.
"A.OFF" remains displayed if disc or tape is selected as the source.

Dimming the display

Use this when you are going to sleep or any other time you would prefer to dim the display panel.

Press **[SHIFT]** + **[DIMMER]**.
To return to the original brightness, press **[SHIFT]**+**[DIMMER]** again.

Enjoying more powerful bass

- Connect an active subwoofer (not included). See below for connection.
- Place the subwoofer as close as possible to the front center.

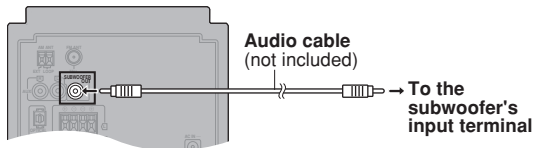

Adjusting the bass

Press **[SHIFT]** + **[SUBWOOFER]**.

SUB W MIN

Every time you press the buttons:
SUB W MIN (factory preset) → SUB W MID → SUB W MAX

Adjust the volume on the subwoofer to suit your preference.

Note
When using headphones, the subwoofer should be switched off.

Muting the volume

Press **[MUTING]**.



Volume is reduced to minimum.

To cancel
Press **[MUTING]** again or reduce the volume to minimum (-dB), then raise it to the required level.
Muting is also cancelled when you switched the unit to standby.

Using headphones

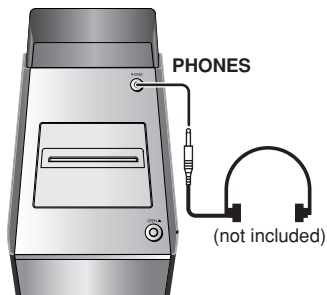

Reduce the volume level and connect the headphones (not included).
Headphones plug type: 3.5 mm (1/8") stereo.

Audio is automatically switched to stereo (2-channel).

Note
Avoid listening for prolonged periods of time to prevent hearing damage.

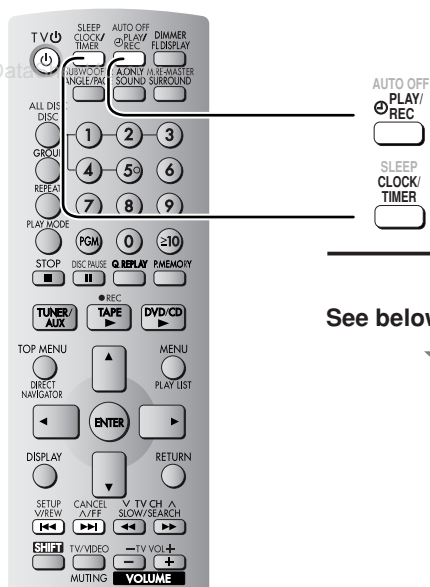

Play/record timer

See below for details.



The play/record timer

You can set the timer to come on at a certain time to wake you up (play timer) or to record a radio station or from the aux source (record timer).
The play and record timers cannot be used together.

- **Switch on the unit and set the clock** (⇒ page 9, Setting the time).
- **For the play timer**, prepare the desired music source (tape/disc/radio/aux), and set the volume.
- **For the record timer**, check the cassette's erasure prevention tabs (⇒ page 24, Erasure prevention) and insert the tape (⇒ page 23, Cassette tapes). Tune to the radio station (⇒ page 22, The radio) or select the aux source (⇒ page 32, Using an external unit).

1 Press [CLOCK/TIMER] to select the timer function.

Every time you press the button:

CLOCK → ⊕PLAY → ⊕REC

↑ Previous display ↓

⊕PLAY: to set the play timer

⊕REC: to set the record timer

2 ON time setting

- ① (Within 6 seconds or so)
Press [◀◀ V/REW] or [▶▶ ^/FF] to set the start time.
- ② Press [CLOCK/TIMER].

3 OFF time setting

- ① Press [◀◀ V/REW] or [▶▶ ^/FF] to set the finish time.
- ② Press [CLOCK/TIMER].

The start and finish times are now set.

4 Press [⊕PLAY/REC] to display the timer indicator.

Every time you press the button:

⊕PLAY → ⊕REC

↑ (off) ↓

⊕PLAY: to turn the play timer on

⊕REC: to turn the record timer on

(The indicator doesn't appear if the start and finish times or the clock have not been set.)

5 Press [⊕] to turn the unit off.

The unit must be off for the timers to operate.

- **Play timer:** Play will start in the set condition at the set time with volume increasing gradually to the set level.
- **Record timer:** The unit comes on 30 seconds before the set time with the volume muted.

To cancel the timer

Press [⊕PLAY/REC] to clear the timer indicator from the display.
(The timer comes on at the set time everyday if the timer is on.)

To change the settings (when the unit is on)

To change the play/record times

Do steps 1, 2, 3 and 5.

To change the source or volume

1. Press [⊕PLAY/REC] to clear the timer indicator from the display.
2. Make changes to the source or volume.
3. Do steps 4 to 5.

To change the timer

Press [⊕PLAY/REC] to select the desired timer.

Every time the button is pressed:

⊕PLAY → ⊕REC

↑ (off) ↓

To check the settings

Press [CLOCK/TIMER] while the unit is on to select "⊕PLAY" or "⊕REC".

The settings are shown in the following order:

Play timer: start time → finish time → source → volume

Record timer: start time → finish time → source

To check the settings while the unit is off, press [CLOCK/TIMER] twice.

If you use the unit after the timers are set

After using, check that the correct tape/disc are loaded before turning the unit off.

Note

- If you turn the unit off and on again while a timer is functioning, the finish time setting will not be activated.
- If you selected AUX as the source, when the timer comes on, the unit turns on and engages "AUX" as the source. If you want to playback or record from a connected unit, set that unit's timer to the same time. (See the connected unit's instruction manual.)

Convenient functions

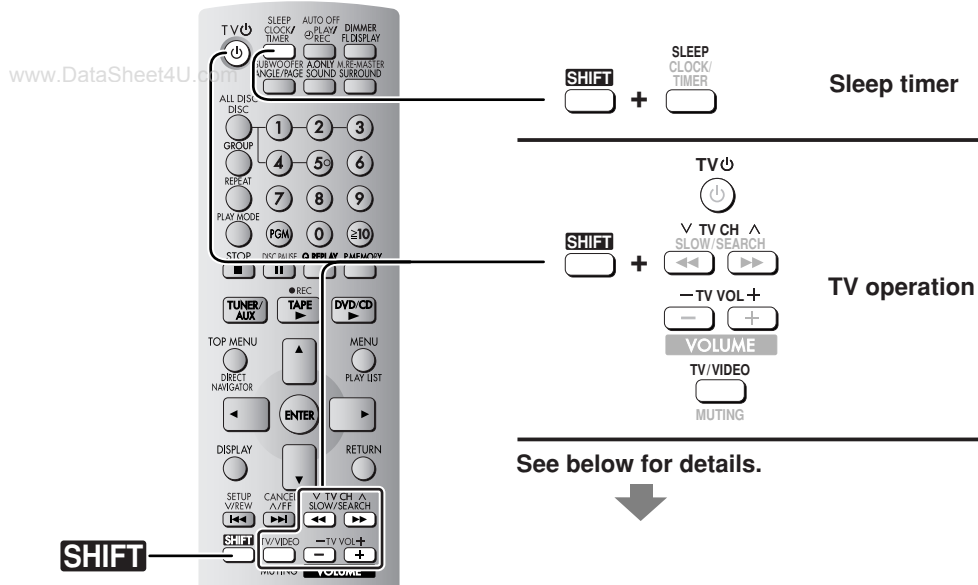

The sleep timer

This timer turns the unit off after a set time.

While enjoying the desired source:

Press [SHIFT] + [SLEEP] to select the time (minutes).

Every time you press the button:

[SLEEP 30] → [SLEEP 60] → [SLEEP 90] → [SLEEP 120] → [SLEEP OFF]

To cancel the sleep timer

Press [SHIFT]+[SLEEP] to select "SLEEP OFF".

To confirm the remaining time

Press [SHIFT]+[SLEEP] once.

The remaining time is shown for about 5 seconds.

To change the setting

Press [SHIFT]+[SLEEP] to select the new setting.

You can use the sleep timer in combination with the play/record timer.

Make sure the unit is off before the play/record timer's start time.

Note

The sleep timer will be turned off when you start recording from a disc.

Operating a television

Face the remote control at the television for the following operations.

Turning the television on/off

Press [SHIFT] + [TV ϕ].

Switching the television's video input mode

Press [SHIFT] + [TV/VIDEO].

Changing channels

Press [SHIFT] + [V TV CH] or [SHIFT] + [TV CH ^].

Adjusting the volume

Press [SHIFT] + [- TV VOL] or [SHIFT] + [TV VOL +].

Note

Some models cannot be operated by this remote control.

Discs — Changing the player's settings

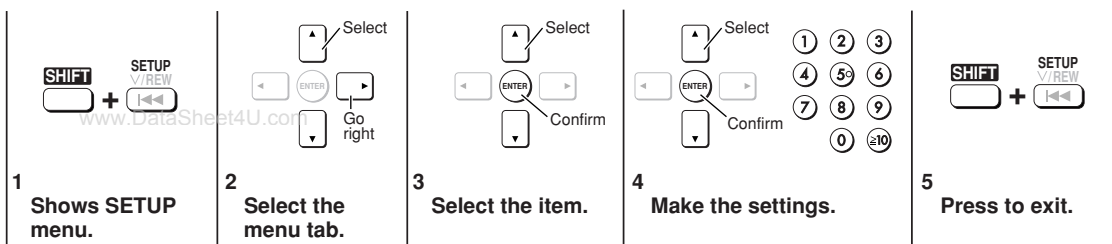

- The settings remain intact even if you switch the unit to standby.
- Underlined items are the factory preset.

■ “Disc” tab—To choose the language and set a rating level

Audio Choose the audio language.	<ul style="list-style-type: none"> • <u>English</u> • Original^{#1} 	<ul style="list-style-type: none"> • (Language options) • Other ****^{#2} 	<i>Language options</i> ^{#4} • French • Spanish
Subtitle Choose the subtitle language.	<ul style="list-style-type: none"> • <u>Automatic</u>^{#3} • (Language options) 	<ul style="list-style-type: none"> • English • Other ****^{#2} 	^{#5} • French • Spanish • Portuguese
Menus Choose the language for disc menus.	<ul style="list-style-type: none"> • <u>English</u> • Other ****^{#2} • Changing the menu language from QUICK SETUP also changes this setting. 	<ul style="list-style-type: none"> • (Language options) 	

Ratings

Set a ratings level to limit DVD-Video play. The password screen is shown when you select levels 0 to 7.

To enter a password

- Input a 4-digit password with the numeric buttons.
 - If you enter a wrong number, press [SHIFT]+[CANCEL] to erase it.
 - **Do not forget your password.**
- Press [ENTER].
 - The lock symbol appears closed to show the rating is locked.
- Press [ENTER] to confirm the 4 digits.

If you insert a DVD-Video that exceeds the ratings limit you set, a message appears on the television. Follow the on-screen instructions.

Setting ratings (When level 8 is selected)

- 8 No Limit
- 1 to 7^{#6}
- 0 Lock All: To prevent play of discs without ratings levels.

Changing ratings (When level 0 – 7 is selected)

- Unlock Player
- Change Level
- Change Password
- Temporary Unlock

■ “Video” tab—To enable progressive output or to make settings to suit your television

TV Aspect

Choose the setting to suit your television and preference.

- Changing the TV aspect from QUICK SETUP also changes this setting.

- 4:3 Pan&Scan: Regular aspect television (4:3)
The sides of the widescreen picture are cut off so it fills the screen (unless prohibited by the disc).
- 4:3 Letterbox: Regular aspect television (4:3)
Widescreen software is shown in letterbox style on a 4:3 aspect television.
- 16:9: Widescreen television (16:9)



Progressive Out (Component)

Choose “Enable” to enable progressive output.

- Disable
- Enable

TV Type

Select to suit the type of television.

- Standard (Direct View TV)
- CRT Projector
- Projection TV
- LCD TV/Projector
- Plasma TV

Time Delay

When connected with an AV amplifier and Plasma display, adjust if you notice the audio is out of sync with the video.

- 0ms
- 60ms
- 20ms
- 80ms
- 40ms
- 100ms

Still Mode

Specify the type of picture shown when paused.

- Automatic
- Frame
- Field

Black Level Control

Change the black level of the picture if you connected a television through the COMPONENT VIDEO OUT terminals.

- Lighter: When connected through VIDEO OUT or S-VIDEO OUT.
- Darker: When connected through COMPONENT VIDEO OUT.

■ “Audio” tab—To make settings to suit your digital connection and other audio settings

PCM Digital Output (→ page 31, Digital output)	• <u>Up to 48 kHz</u>	• Up to 96 kHz
Digital Audio Output (→ page 31, Digital output)	• <u>On</u>	• Off
Dolby Digital (→ page 31, Digital output)	• <u>Bitstream</u>	• PCM
DTS Digital Surround (→ page 31, Digital output)	• <u>PCM</u>	• Bitstream
Dynamic Range Compression (Dolby Digital only)	• <u>Off</u> • On: Adjust for clarity even when the volume is low through compressing the range of the lowest sound level and the highest sound level. Convenient for late night viewing.	
Audio during Search Choose whether to have sound during search.	• <u>On</u> (This feature does not work for some discs.)	• Off

■ “Display” tab—To choose the on-screen message language or to turn languages off

Menu Language Choose the language for these menus and the on-screen messages.	#4 • <u>English</u> • Français • Español #5 • <u>English</u> • Français • Español • Português
On-Screen Messages Choose whether to show on-screen messages or not.	• <u>On</u> • Off

■ “Others” tab— To select either still picture data or audio data when playing discs including both data and other settings

HighMAT Play HighMAT discs as HighMAT discs, or as regular WMA/MP3/JPEG discs.	• <u>Enable</u> : Play HighMAT discs as HighMAT discs. • <u>Disable</u> : Play HighMAT discs as regular WMA/MP3/JPEG discs.
QUICK SETUP Answers questions to make basic settings.	• <u>Yes</u> • No
Re-initialize Setting This returns all values in the SETUP menus to the default settings.	• <u>Yes</u> : The password screen is shown if “Ratings” (→ page 29, “Disc” tab) are set. Please enter the same password. Turn the unit off and on again. • <u>No</u>

#1 The original language of each disc is selected.

#2 Input a code number with the numbered buttons (→ page 33, Language code list).

#3 If the language selected for “Audio” is not available, subtitles of that language will automatically appear if it is available on that disc.

#4 **For U.S.A. and Canada**

#5 **For Latin America**

#6 Prohibits play of DVD-Video with corresponding ratings recorded on them.

Digital output

RAM DVD-A DVD-V VCD CD WMA MP3

Change the settings when you have connected equipment through this unit's OPTICAL OUT terminal (➔ page 32, Home Theater—Enjoying more powerful sound).

PCM Digital Output

Select the maximum sampling frequency of PCM digital output. Check the digital input limitations of the equipment you connect.

Off: When not connected digitally

Up to 48 kHz (factory preset):

Signals over 48 kHz converted to 48 or 44.1 kHz

Up to 96 kHz: Signals over 96 kHz converted to 48 or 44.1 kHz

Note

- Signals from copy-protected discs are converted to 48 or 44.1 kHz irrespective of the setting.
- Some equipment cannot handle sampling frequencies of 88.2 kHz, even if it can handle 96 kHz. Read your equipment's operating instructions for details.

Dolby Digital and DTS Digital Surround

Bitstream (Factory preset for Dolby Digital):

Select if the equipment you connected can decode the signal.

PCM (Factory preset for DTS Digital Surround):

Select if the equipment you connected cannot decode the signal.

IMPORTANT

If the equipment you connected cannot decode the signal, the setting must be changed to PCM. If not, signals the equipment cannot process will be output by this unit, causing high levels of noise which can damage your hearing and the speakers.

Manufactured under license from Dolby Laboratories. "Dolby" and the double-D symbol are trademarks of Dolby Laboratories.

"DTS" and "DTS Digital Surround" are registered trademarks of Digital Theater Systems, Inc.

HDCD[®], HDCD[®], High Definition Compatible Digital[®] and Pacific Microsonics[™] are either registered trademarks or trademarks of Pacific Microsonics, Inc. in the United States and/or other countries.

HDCD system manufactured under license from Pacific Microsonics, Inc. This product is covered by one or more of the following: In the USA: 5,479,168, 5,638,074, 5,640,161, 5,808,574, 5,838,274, 5,854,600, 5,864,311, 5,872,531, and in Australia: 669114, with other patents pending.

Apparatus Claims of U.S. Patent Nos. 4,631,603, 4,577,216, and 4,819,098, licensed for limited viewing uses only.

This product incorporates copyright protection technology that is protected by method claims of certain U.S. patents and other intellectual property rights owned by Macrovision Corporation and other rights owners. Use of this copyright protection technology must be authorized by Macrovision Corporation, and is intended for home and other limited viewing uses only unless otherwise authorized by Macrovision Corporation. Reverse engineering or disassembly is prohibited.

Using other equipment

Before connection

- Disconnect the AC power supply cord.
- Turn off all equipment and read the appropriate operating instructions.
- The equipment connections described are examples only.
- Peripheral equipment and optional cables sold separately unless otherwise indicated.

Home Theater — Enjoying more powerful sound

Enjoy the powerful movie theater and hall-like sound available with multiple channel audio found on DVD-Video by connecting an amplifier and speakers. **(DVD-A)** Even if using this connection, output will be only 2 channels.)

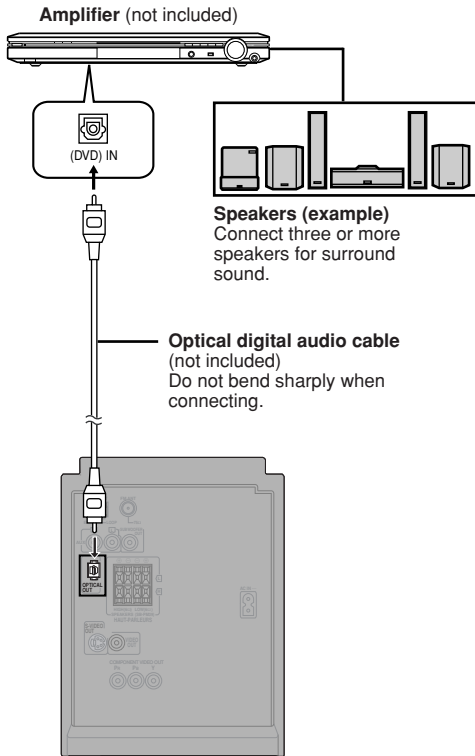

To enjoy multi-channel surround sound

Connect an amplifier with a built-in decoder or a decoder-amplifier combination.

Change the settings in "Digital output" (→ page 31).

- You can only use DTS Digital Surround decoders that are compatible with DVD.

Recording Output

- With DVD, the following conditions must be met: **(a)** the disc doesn't have protection preventing digital recording, and **(b)** the recording equipment can handle signals with a sampling frequency of 48 kHz.
- You cannot record WMA/MP3.

When recording DVDs, make the following settings.

- Advanced Surround: SURR OFF (→ page 25)
- PCM Digital Output: Up to 48 kHz (→ page 31, Digital output)
- Dolby Digital and DTS Digital Surround: PCM (→ page 31, Digital output)

Using an external unit

You can playback the sound from a video cassette recorder, tape deck, laser disc player, etc., through this unit's speakers.

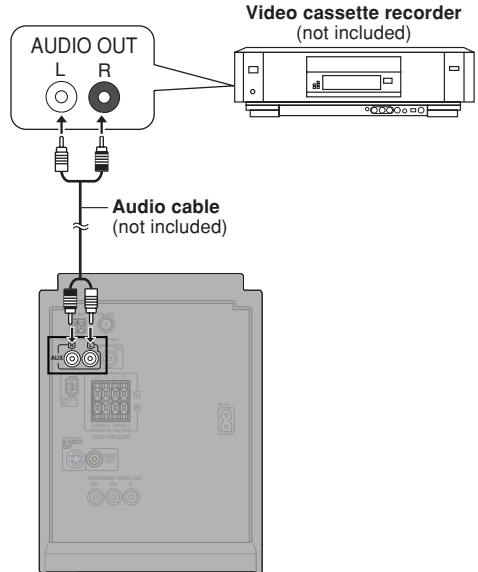

When connecting a record player

We recommend using a record player with a built-in phono equalizer. If your player doesn't have a built-in equalizer, connect it first to a separate equalizer and then connect that to this unit.

To playback

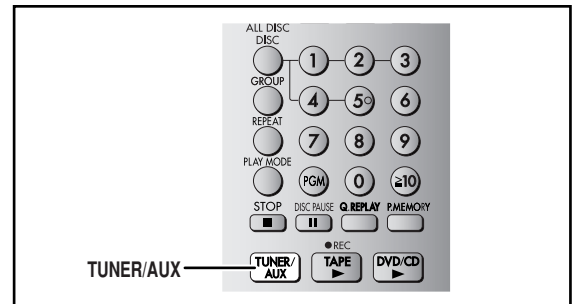

1 Press [TUNER/AUX] to select "AUX".

The unit comes on.
Every time you press the button:

FM → AM → AUX

2 Start playback from the external source.

(For details, refer to the external unit's instruction manual.)

Language code list

Abkhazian:	6566	Danish:	6865	Italian:	7384	Norwegian:	7879	Swedish:	8386
Afar:	6565	Dutch:	7876	Japanese:	7465	Oriya:	7982	Tagalog:	8476
Afrikaans:	6570	English:	6978	Javanese:	7487	Pashto, Pushto:	8083	Tajik:	8471
Albanian:	8381	Esperanto:	6979	Kannada:	7578	Persian:	7065	Tamil:	8465
Ameharic:	6577	Estonian:	6984	Kashmiri:	7583	Polish:	8076	Tatar:	8484
Arabic:	6582	Faroese:	7079	Kazakh:	7575	Portuguese:	8084	Telugu:	8469
Armenian:	7289	Fiji:	7074	Kirghiz:	7589	Punjabi:	8065	Thai:	8472
Assamese:	6583	Finnish:	7073	Korean:	7579	Quechua:	8185	Tibetan:	6679
Aymara:	6588	French:	7082	Kurdish:	7585	Rhaeto-Romance:	8277	Tigrinya:	8473
Azerbaijani:	6590	Frisian:	7089	Laotian:	7679	Romanian:	8279	Tonga:	8479
Bashkir:	6665	Galician:	7176	Latin:	7665	Russian:	8285	Turkish:	8482
Basque:	6985	Georgian:	7565	Latvian, Lettish:	7686	Samoan:	8377	Turkmen:	8475
Bengali, Bangla:	6678	German:	6869	Lingala:	7678	Sanskrit:	8365	Twi:	8487
Bhutani:	6890	Greek:	6976	Lithuanian:	7684	Scots Gaelic:	7168	Ukrainian:	8575
Bihari:	6672	Greenlandic:	7576	Macedonian:	7775	Serbian:	8382	Urdu:	8582
Breton:	6682	Guarani:	7178	Malagasy:	7771	Serbo-Croatian:	8372	Uzbek:	8590
Bulgarian:	6671	Gujarati:	7185	Malay:	7783	Shona:	8378	Vietnamese:	8673
Burmese:	7789	Hausa:	7265	Malayalam:	7776	Sindhi:	8368	Volapük:	8679
Byelorussian:	6669	Hebrew:	7387	Maltese:	7784	Singhalese:	8373	Welsh:	6789
Cambodian:	7577	Hindi:	7273	Maori:	7773	Slovak:	8375	Wolof:	8779
Catalan:	6765	Hungarian:	7285	Marathi:	7782	Slovenian:	8376	Xhosa:	8872
Chinese:	9072	Icelandic:	7383	Moldavian:	7779	Somali:	8379	Yiddish:	7473
Corsican:	6779	Indonesian:	7378	Mongolian:	7778	Spanish:	6983	Yoruba:	8979
Croatian:	7282	Interlingua:	7365	Nauru:	7865	Sundanese:	8385	Zulu:	9085
Czech:	6783	Irish:	7165	Nepali:	7869	Swahili:	8387		

Optional antenna connections

Use outdoor antenna if radio reception is poor.

FM outdoor antenna (Using a television antenna)

- Disconnect the FM indoor antenna.
- The antenna should be installed by a competent technician.

Rework your outdoor antenna's 75 Ω coaxial cable as follows.

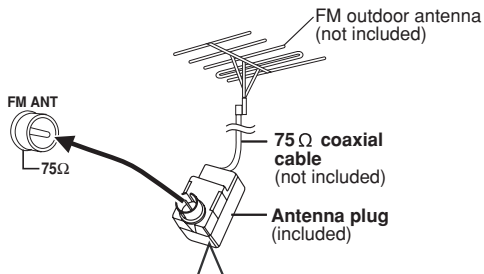

For U.S.A. and Canada only

- 1 Remove a piece of the outer vinyl insulator.
- 2 Carefully pull the tabs apart to remove the cover.
- 3 Install the coaxial cable. Clamp the cable conductor, and wind it on so that it does not contact anything else.
- 4 Attach the cover.

Clamp with pliers

AM outdoor antenna

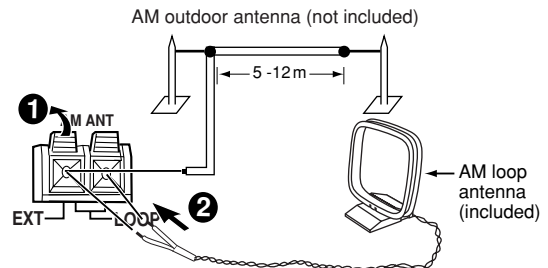

- Run a piece of vinyl wire horizontally across a window or other convenient location.
- Leave the loop antenna connected.

Note

Disconnect the outdoor antenna when the unit is not in use. Do not use the outdoor antenna during a lightning storm.

Troubleshooting guide

Before requesting service, make the following checks. If you are in doubt about some of the check points, or if the remedies indicated in the chart do not solve the problem, refer to the "Customer Services Directory" on page 39 if you reside in the U.S.A., or refer to "Product information" on page 4 if you reside in Canada.

www.DataSheet4U.com

Power		Page
No power.	<ul style="list-style-type: none"> Insert the AC power supply cord securely. 	8
The unit is automatically switched to the standby mode.	<ul style="list-style-type: none"> The unit was switched to standby by the sleep timer or auto-off function. 	26, 28

Operation

No response when any buttons are pressed.	<ul style="list-style-type: none"> Some operations may be prohibited by the disc. The unit may not be operating properly due to lightning, static electricity or some other external factor. Turn the unit off and then back to ON. Alternatively, press [⏻] to switch the unit to standby mode, disconnect the AC mains lead, and then reconnect it. 	–
No operations can be performed with the remote control.	<ul style="list-style-type: none"> Check that the batteries are installed correctly. The batteries are depleted: replace them with new ones. Point the remote control at the remote control sensor and operate. 	8 8 –
Cannot switch on the television with the remote control.	<ul style="list-style-type: none"> Press [SHIFT]+[TV ⏻] first to operate the television. 	28
Play doesn't start (or stops immediately) when you press [▶ DVD/CD].	<ul style="list-style-type: none"> Condensation has formed: Wait 1 to 2 hours for it to evaporate. This unit cannot play discs other than the ones listed in these operating instructions. You can only play DVD-Video if their region number is the same or includes the same region number as the unit or if DVD-Video is marked "ALL". Confirm the region number for the unit on the rear panel. The disc may be dirty and may require cleaning. Ensure that the disc is loaded with the label of the side to be played facing upwards. Check that the DVD-RAM has something recorded on it. 	– 5, 17 Cover 5 12 –
Cannot select alternative languages.	<ul style="list-style-type: none"> This function is dependent on software availability. Try selecting from the disc's menu if one is available. 	– 13
No menu play.	<ul style="list-style-type: none"> This function is dependent on software availability. 	–
No subtitles.	<ul style="list-style-type: none"> This function is dependent on software availability. Subtitles are cleared from the television. Turn on the subtitles. 	– 19
The position of the subtitles is incorrect.	<ul style="list-style-type: none"> Change the position of the subtitles with "Subtitle Position" in the Display Menu. 	21
Soundtrack and/or subtitle language is not the one selected with the SETUP menus.	<ul style="list-style-type: none"> This function is dependent on software availability. 	–
Cannot change angle.	<ul style="list-style-type: none"> This function is dependent on software availability. Even if a disc has a number of angles recorded, these angles may be recorded for specific scenes only. 	–
The SETUP menu cannot be accessed.	<ul style="list-style-type: none"> Select "DVD/CD" as the source. Cancel all group, program and random play. 	– 15
Cannot add markers.	<ul style="list-style-type: none"> You cannot add markers while playing a play list or if the disc's play time doesn't appear on the unit's display. 	–
There are already markers. RAM	<ul style="list-style-type: none"> The unit reads and displays the markers added with a DVD video recorder. You can clear them but they will reappear when you switch the unit to standby, change the source, or open the disc tray. 	–
Cannot select random or program play.	<ul style="list-style-type: none"> You cannot select random or program play with some DVD-Video. 	–
Folders deeper than the eighth layer on a data disc are not displayed correctly.	<ul style="list-style-type: none"> Folders deeper than the eighth layer are displayed as the eighth layer. 	–
You have forgotten your ratings password. Reset all the SETUP settings to Factory Preset.	<ul style="list-style-type: none"> While stopped and "DVD/CD" is the source, press and hold [■ STOP] on the unit and [≥10] on the remote control for about 3 seconds until "Initialized" disappears from the television. Turn the unit off and on again. All settings will return to the default values. 	–
The unit doesn't play the data type (WMA/MP3 or JPEG) selected in the "Audio" or "Picture" in the Playback menu displayed on the screen.	<ul style="list-style-type: none"> Reload the disc for the settings to take effect. Press [OPEN/CLOSE ▲] to open the tray, then press [▶ DVD/CD] to start play. 	–
Cannot eject disc.	<ul style="list-style-type: none"> The unit may not operate properly if the disc is damaged or dirty. Press [⏻] and after the display disappears, wait a few seconds, then press [⏻] again and eject the disc. 	–

Listening to the radio

Noise is heard. "ST" flickers or doesn't light. Sound is distorted.	<ul style="list-style-type: none"> Adjust the position of the FM or AM antenna. Use an outdoor antenna. 	– 33
A beat sound is heard.	<ul style="list-style-type: none"> Turn the television off or separate it from the unit. 	–
A low hum is heard during AM broadcasts.	<ul style="list-style-type: none"> Separate the antenna from other cables and cords. 	–

Using the cassette deck

Poor quality sound.	<ul style="list-style-type: none"> Clean the heads. 	36
Recording is not possible.	<ul style="list-style-type: none"> If the erasure prevention tabs have been removed, cover the holes with adhesive tape. 	24

Sound

No sound. Distorted sound.	<ul style="list-style-type: none"> Check the connections. Turn the volume up. Turn muting off. Turn Advanced surround off if it causes distortion. Switch off the unit, determine and correct the causes, then switch the unit on. Causes include: <ul style="list-style-type: none"> Shorting (bare wires touching) of positive and negative speaker wires. Using speakers with an impedance lower than that rated for this unit. Straining of the speakers through excessive volume or power. Using the unit in a hot environment without proper ventilation. 	6 – 26 25 –
Piercing noise comes from the speakers.	<ul style="list-style-type: none"> If you have connected this unit to other equipment through the OPTICAL OUT terminal, ensure you have selected the correct settings for "Dolby Digital" and "DTS Digital Surround" in the SETUP menus' "Audio" tab. 	31

Picture

Picture distorted.	<ul style="list-style-type: none"> Some distortion is normal during SEARCH. 	–
No picture.	<ul style="list-style-type: none"> Check the connection. Make sure the television is on. Ensure the television's video input setting (e.g., VIDEO 1) is correct. 	7 – –
The picture shown on the television is not normal. (The sides of the picture are cut off, the picture is stretched horizontally, or black bands appear at the top and bottom of the screen.)	<ul style="list-style-type: none"> Go to "Video" tab in the SETUP menus, and change "TV Aspect" to suit your television. Use the television to change the aspect to the correct one. If your television cannot change the aspect when input is progressive, try changing 4:3 Aspect in Picture Menu. Ensure that the unit is connected directly to the television, and is not connected through a video cassette recorder. Change the size with the zoom function. Connect to the component video (480P) input terminals on a television compatible with this unit's copy guard system. You cannot view progressive video if your television is not compatible. The images on PAL system DVD-Audio are compressed for display. They may also appear vertically stretched. 	29 – 20 – 21 7 –
There is ghosting when progressive output is on.	<ul style="list-style-type: none"> Change "Video Output Mode" to "480I" so "PROGRESSIVE" on the display goes out. This problem is caused by the editing method or material used on DVD-Video, but should be corrected if you use interlace output. 	20
Picture quality is poor.	<ul style="list-style-type: none"> Check the settings in Picture Menu. 	20
The picture on the television disappears or stripes appear on the screen.	<ul style="list-style-type: none"> Mobile telephone chargers can cause some disturbance. The location and orientation of the antenna are incorrect. If you are using an indoor antenna, change to an outdoor antenna. The television antenna wire is too close to the unit. Separate the antenna wire of the television from the unit. 	– 33 –
Menus not displayed correctly.	<ul style="list-style-type: none"> Change the zoom ratio to "x1.00". Set "Subtitle Position" in Display Menu to "0". Set "4:3 Aspect" in Display Menu to "Normal". 	21 21 21

Unit displays

Although the unit is in standby mode, the display lights up and changes continuously.	<ul style="list-style-type: none"> Turn off the demo function. If you set the clock, demo function will be turned off automatically. 	9 9
The display is dark.	<ul style="list-style-type: none"> Press [SHIFT]+[DIMMER] until the display returns to the original brightness. 	26
"DVD NO PLAY"	<ul style="list-style-type: none"> You inserted a disc which the unit cannot play; insert one that can. You inserted a blank DVD-RAM disc. 	5 –
"DVD NO DISC"	<ul style="list-style-type: none"> You haven't inserted a disc; insert one. You haven't inserted the disc correctly; insert it correctly. 	– 12, 37
"F61"	<ul style="list-style-type: none"> Check and correct the speaker cord connections. If this does not fix the problem, there is a power supply problem. Consult the dealer. 	6
"DVD U11"	<ul style="list-style-type: none"> Disc is dirty. Wipe it clean. 	5
"ERROR"	<ul style="list-style-type: none"> Incorrect operation performed. Read the instructions and try again. 	–
"DVD H□□" □□ stands for a number.	<ul style="list-style-type: none"> Trouble may have occurred. The number following "H" depends on the status of the unit. Reset procedure: Press [⏻] to switch the unit to standby mode and then back to ON. Alternatively, press [⏻] to switch the unit to standby mode, disconnect the AC mains lead, and then reconnect it. If the service numbers fail to clear, note the service number and contact a qualified service person. 	– –

Television displays

“Cannot display group xx, content xx.”	• You are trying to display incompatible contents.	—
“The progressive out is set to “Disable”.” <small>iaSheet4U.com</small>	• Go to “Video” tab in the SETUP menus, and select “Enable” in “Progressive Out (Component)”.	29
No on-screen display.	• Go to “Display” tab in the SETUP menus, and select “On” for “On-Screen Messages”.	30
The disc’s menu is displayed in a different language.	• Go to “Disc” tab in the SETUP menus, and select the preferred language for “Menus”.	29



Listening caution



Selecting fine audio equipment such as the unit you’ve just purchased is only the start of your musical enjoyment. Now it’s time to consider how you can maximize the fun and excitement your equipment offers. This manufacturer and the Electronic Industries Association’s Consumer Electronics Group want you to get the most out of your equipment by playing it at a safe level. One that lets the sound come through loud and clear without annoying blaring or distortion—and, most importantly, without affecting your sensitive hearing.

We recommend that you avoid prolonged exposure to excessive noise.

Sound can be deceiving. Over time your hearing “comfort level” adapts to higher volumes of sound. So what sounds “normal” can actually be loud and harmful to your hearing.

Guard against this by setting your equipment at a safe level BEFORE your hearing adapts.

To establish a safe level:

- Start your volume control at a low setting.
- Slowly increase the sound until you can hear it comfortably and clearly, and without distortion.

Once you have established a comfortable sound level:

- Set the dial and leave it there.

Taking a minute to do this now will help to prevent hearing damage or loss in the future. After all, we want you listening for a lifetime.

Maintenance

To clean this unit, wipe with a soft, dry cloth.

- Never use alcohol, paint thinner or benzine to clean this unit.
- Before using chemically treated cloth, read the instructions that came with the cloth carefully.

For a cleaner, crisper sound (cassette deck)

Clean the heads regularly to assure good quality playback and recording. Use a cleaning tape (not included).

When moving the unit

- 1 Remove all discs.**
- 2 Press [⏻/I POWER] on the main unit to turn it off.**
- 3 Disconnect the AC mains lead.**

Decoder

A decoder restores the coded audio signals on DVDs to normal. This is called decoding.

Dolby Digital

This is a method of coding digital signals developed by Dolby Laboratories. Apart from stereo (2-channel) audio, these signals can also be multi-channel audio. A large amount of audio information can be recorded on one disc using this method.

DTS (Digital Theater Systems)

This surround system is used in many movie theaters around the world. There is good separation between the channels, so realistic sound effects are possible.

Dynamic range

Dynamic range is the difference between the lowest level of sound that can be heard above the noise of the equipment and the highest level of sound before distortion occurs.

Film and video

DVD-Videos are recorded using either film or video. Usually, film is recorded at 24 frames per second, the rate movies are filmed at, while video is recorded at 30 frames per second.

Frame still and field still

Frames are the still pictures that go together to make a moving picture. There are about 30 frames shown each second.

One frame is made up of two fields. A regular television shows these fields one after the other to create frames.

A still is shown when you pause a moving picture. A frame still is made up of two alternating fields, so the picture may appear blurred, but overall quality is high.

A field still is not blurred, but it has only half the information of a frame still so picture quality is lower.

Interlace and progressive output

NTSC, the video signal standard, has 480 interlaced (I) scan lines, whereas progressive scanning uses twice the number of scan lines. This is called 480P. The video signals output from this unit's COMPONENT VIDEO OUT terminals (Y, P_B, P_R) allow you to enjoy higher quality pictures than if the signals were output from the VIDEO OUT terminal or S-VIDEO OUT terminal.

I/P/B

MPEG 2, the video compression standard adapted for use with DVD-Video, codes frames using these 3 picture types.

I: Intra coded picture

This picture has the best quality and is the best to use when adjusting the picture.

P: Predictive coded picture

This picture is calculated based on past I or P-pictures.

B: Bidirectionally-predictive coded picture

This picture is calculated by comparing past and future I and P-pictures so it has the lowest volume of information.

Linear PCM (pulse code modulation)

These are uncompressed digital signals, similar to those found on CDs.

Playback control (PBC)

If a Video CD has playback control, you can select scenes and information with menus.

Not adhering to the following may cause problems.

Opening/closing a disc tray

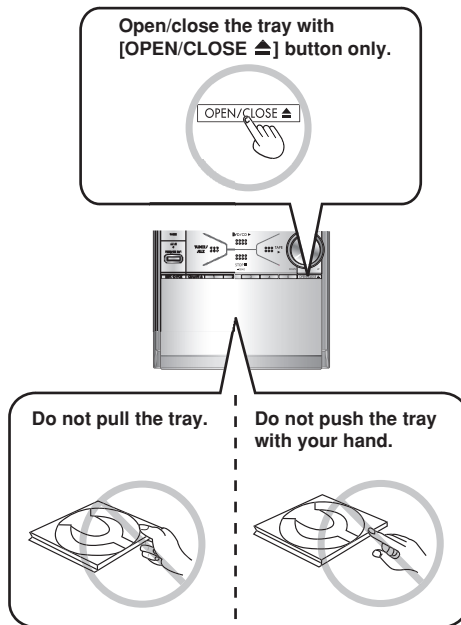

Inserting a disc correctly

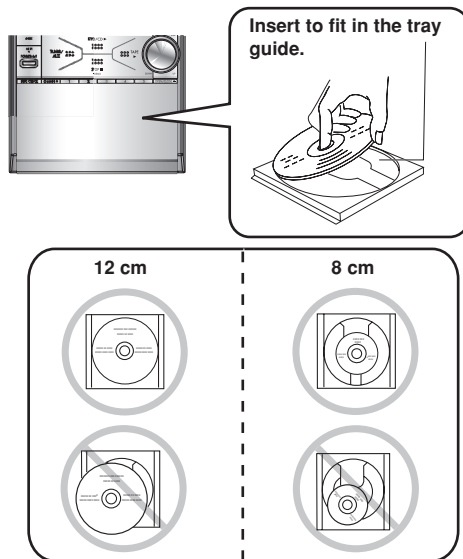

- Insert the disc correctly in the position indicated in the diagrams above.
- Place only one disc on a tray.
- Insert the disc with the label side facing up.

AMPLIFIER SECTION

RMS Output Power Stereo mode (Both channel driven)	
10% total harmonic distortion	
1 kHz	(Low channel) 35 W per channel (6Ω)
8 kHz	(High channel) 35 W per channel (6Ω)
Total RMS Stereo mode power	140 W
FTC Output Power Stereo mode (Both channel driven)	
10% total harmonic distortion	
60 Hz – 3 kHz	(Low channel) 30 W per channel (6Ω)
3 kHz – 16 kHz	(High channel) 30 W per channel (6Ω)
Total FTC Stereo mode power	60 W per channel
Phone jack	
Terminal	Stereo, 3.5 mm (1/8") jack

FM TUNER SECTION

Frequency range	87.9 – 107.9 MHz (200 kHz step)
	87.5 – 108.0 MHz (100 kHz step)
Sensitivity	2.5 μV (IHF)
S/N 26 dB	2.2 μV
Antenna terminals	75 Ω (unbalance)
Preset stations	15

AM TUNER SECTION

Frequency range	520 – 1710 kHz (10 kHz steps)
Sensitivity	
S/N 20 dB at 1000 kHz	560 μV/m
Preset stations	15

CASSETTE DECK SECTION

Track system	4-track, 2-channel
Heads	
Record/playback	Solid permalloy head
Erasure	Double gap ferrite head
Motor	DC servo motor
Recording system	AC bias 100 kHz
	AC erase 100 kHz
Tape speed	4.8 cm/s (1–7/8 ips)
Overall frequency response (+3, –6 dB) at DECK OUT	
Normal (TYPE I)	35 Hz–14 kHz
S/N ratio	50 dB (A weighted)
Wow and flutter	0.18% (WRMS)
Fast forward and rewind time	Approx. 120 seconds with C-60 cassette tape

DISC SECTION

Disc played [8 cm (3") or 12 cm (5")]	
(1)	DVD-RAM (DVD-VR compatible, JPEG formatted disc)
(2)	DVD-Audio
(3)	DVD-Video
(4)	DVD-R (DVD-Video compatible)
(5)	CD-Audio (CD-DA)
(6)	Video CD
(7)	SVCD (Conforming to IEC62107)
(8)	CD-R/CD-RW (CD-DA, Video-CD, SVCD, MP3, WMA, JPEG formatted disc)
(9)	MP3/WMA* <ul style="list-style-type: none"> • Compatible compression rate: <ul style="list-style-type: none"> MP3: between 32 kbps and 320 kbps WMA: between 48 kbps and 320 kbps
(10)	JPEG* <ul style="list-style-type: none"> • Exif Ver 2.1 JPEG Baseline files • Picture resolution: <ul style="list-style-type: none"> between 320x240 and 6144x4096 pixels (Sub sampling is 4:2:2 or 4:2:0)
(11)	HighMAT Level 2 (Audio and Image)

* The total combined maximum number of recognizable audio and picture contents and groups: 4000 audio and picture contents and 400 groups.

Video system	NTSC
Composite video output	
Output level	1 Vp-p (75 Ω)
Terminal	Pin jack (1 system)
S-VIDEO output	
Y output level	1 Vp-p (75 Ω)
C output level	0.286 Vp-p (75 Ω) (NTSC)
Terminal	S terminal (1 system)
Component video output (480P/480I)	
Y output level	1 Vp-p (75 Ω)
P _B output level	0.7 Vp-p (75 Ω)
P _R output level	0.7 Vp-p (75 Ω)
Terminal	Pin jack (Y:green, P _B : blue, P _R :red) (1 system)

Audio output	
Number of channels	2
Digital audio output	
Optical digital output	Optical terminal
Pick up	
Wavelength	
DVD	662 nm
CD	785 nm
Laser power	
For U.S.A.	CLASS IIa/CLASS I
For Canada and Latin America	CLASS 2/CLASS 3a

SPEAKER SECTION

Type	3 way, 3 speaker system (Bass reflex)
Speaker units	
Woofer	10 cm (4") cone type
Tweeter	6 cm (2 3/8") ring shaped dome type
Super tweeter	Piezo type
Impedance	
High	6 Ω
Low	6 Ω
Input power (IEC)	High 35 W (Max)
	Low 35 W (Max)
Output sound pressure level	80 dB/W (1.0 m)
Crossover frequency	2.6 kHz, 10 kHz
Frequency range	42 Hz–50 kHz (–16 dB)
	52 Hz–45 kHz (–10 dB)
Dimensions (WxHxD)	145 x 250 x 274 mm
	(5 23/32" x 9 27/32" x 10 25/32")
Mass	2.6 kg (5.7 lbs)

GENERAL

Power supply	AC 120V, 60 Hz
Power consumption	130 W
Dimensions (WxHxD)	174.6 x 251 x 376 mm
	(6 7/8" x 9 7/8" x 14 13/16")
Mass	5.7 kg (12.6 lbs)
Operating temperature range	+ 5°C to + 35°C (+41°F to +95°F)
Operating humidity range	5% to 90% RH (no condensation)

Power consumption in standby mode	0.5 W
--	-------

Note

1. Specifications are subject to change without notice. Mass and dimensions are approximate.
2. Total harmonic distortion is measured by digital spectrum analyzer.

Limited Warranty (ONLY FOR U.S.A.)

Panasonic Consumer Electronics Company,
Division of Matsushita Electric Corporation of America
One Panasonic Way Secaucus, New Jersey 07094

Panasonic Sales Company, Division of Matsushita Electric
of Puerto Rico, Inc.
Ave. 65 de Infantería, Km. 9.5
San Gabriel Industrial Park, Carolina, Puerto Rico 00985

www.DataSheet4U.com

Panasonic Audio Products Limited Warranty

Limited Warranty Coverage

If your product does not work properly because of a defect in materials or workmanship, Panasonic Consumer Electronics Company or Panasonic Sales Company (collectively referred to as "the warrantor") will, for the length of the period indicated on the chart below, which starts with the date of original purchase ("warranty period"), at its option either (a) repair your product with new or refurbished parts, or (b) replace it with a new or a refurbished product. The decision to repair or replace will be made by the warrantor.

Product or Part Name	Parts	Labor
Audio Products (except items listed below)	One (1) year	One (1) year
All Audio Racks (cabinets)	Thirty (30) days	Not Applicable
Stand Alone Speakers, Subwoofer Speakers	Three (3) years	Three (3) years
USB Reader-Writer, Personal Computer Card Adapters (in exchange for defective item)	One (1) year	Not Applicable
Accessories: Headphones, Cartridges, Microphones, Adapters	Ninety (90) days	Ninety (90) days
Rechargeable Batteries (in exchange for defective item)	Ten (10) days	Not Applicable
SD Memory Cards, Rechargeable Battery Packs (in exchange for defective item)	Ninety (90) days	Not Applicable

During the "Labor" warranty period there will be no charge for labor. During the "Parts" warranty period, there will be no charge for parts. You must carry-in or mail-in your product during the warranty period. If non-rechargeable batteries are included, they are not warranted. This warranty only applies to products purchased and serviced in the United States or Puerto Rico. This warranty is extended only to the original purchaser of a new product which was not sold "as is". A purchase receipt or other proof of the original purchase date is required for warranty service.

Carry-In or Mail-In Service

For Carry-In or Mail-In Service in the United States call 1-800-211-PANA (1-800-211-7262) or visit Panasonic web site: <http://www.panasonic.com>
For assistance in Puerto Rico call Panasonic Sales Company (787)-750-4300 or fax (787)-768-2910.

Limited Warranty Limits And Exclusions

This warranty ONLY COVERS failures due to defects in materials or workmanship, and DOES NOT COVER normal wear and tear or cosmetic damage. The warranty ALSO DOES NOT COVER damages which occurred in shipment, or failures which are caused by products not supplied by the warrantor, or failures which result from accidents, misuse, abuse, neglect, mishandling, misapplication, alteration, faulty installation, set-up adjustments, misadjustment of consumer controls, improper maintenance, power line surge, lightning damage, modification, or commercial use (such as in a hotel, office, restaurant, or other business), rental use of the product, service by anyone other than a Factory Servicenter or other Authorized Servicer, or damage that is attributable to acts of God.

THERE ARE NO EXPRESS WARRANTIES EXCEPT AS LISTED UNDER "LIMITED WARRANTY COVERAGE". THE WARRANTOR IS NOT LIABLE FOR INCIDENTAL OR CONSEQUENTIAL DAMAGES RESULTING FROM THE USE OF THIS PRODUCT, OR ARISING OUT OF ANY BREACH OF THIS WARRANTY. (As examples, this excludes damages for lost time, travel to and from the servicer, loss of media or images, data or other memory content. The items listed are not exclusive, but are for illustration only.) **ALL EXPRESS AND IMPLIED WARRANTIES, INCLUDING THE WARRANTY OF MERCHANTABILITY, ARE LIMITED TO THE PERIOD OF THE LIMITED WARRANTY.**

Some states do not allow the exclusion or limitation of incidental or consequential damages, or limitations on how long an implied warranty lasts, so the exclusions may not apply to you.

This warranty gives you specific legal rights and you may also have other rights which vary from state to state. If a problem with this product develops during or after the warranty period, you may contact your dealer or Servicenter. If the problem is not handled to your satisfaction, then write to the warrantor's Consumer Affairs Department at the addresses listed for the warrantor.

PARTS AND SERVICE WHICH ARE NOT COVERED BY THIS LIMITED WARRANTY ARE YOUR RESPONSIBILITY.

Customer Services Directory

Obtain Product Information and Operating Assistance; locate your nearest Dealer or Servicenter; purchase Parts and Accessories; or make Customer Service and Literature requests by visiting our Web Site at:

<http://www.panasonic.com/support>

or, contact us via the web at:

<http://www.panasonic.com/contactinfo>

You may also contact us directly at:

1-800-211-PANA (7262),

Monday-Friday 9 am-9 pm; Saturday-Sunday 10 am-7 pm, EST.

For hearing or speech impaired TTY users, TTY: 1-877-833-8855

Accessory Purchases

Purchase Parts, Accessories and Instruction Books online for all Panasonic Products by visiting our Web Site at:

<http://www.pasc.panasonic.com>

or, send your request by E-mail to:

npcparts@panasonic.com

You may also contact us directly at:

1-800-332-5368 (Phone) 1-800-237-9080 (Fax Only) (Monday - Friday 9 am to 8 pm, EST.)

Panasonic Services Company

20421 84th Avenue South, Kent, WA 98032

(We Accept Visa, MasterCard, Discover Card, American Express, and Personal Checks)

For hearing or speech impaired TTY users, TTY: 1-866-605-1277

Service in Puerto Rico

Matsushita Electric of Puerto Rico, Inc. Panasonic Sales Company

Factory Servicenter:

Ave. 65 de Infantería, Km. 9.5, San Gabriel Industrial Park, Carolina, Puerto Rico 00985

Phone (787)750-4300, Fax (787)768-2910

www.DataSheet4U.com

Reference

RQT7509

39

**Panasonic Consumer Electronics
Company, Division of Matsushita
Electric Corporation of America**
One Panasonic Way Secaucus,
New Jersey 07094
<http://www.panasonic.com>

**Panasonic Sales Company,
Division of Matsushita Electric of
Puerto Rico, Inc. ("PSC")**
Ave. 65 de Infantería, Km. 9.5
San Gabriel Industrial Park, Carolina,
Puerto Rico 00985

Panasonic Canada Inc.
5770 Ambler Drive
Mississauga, Ontario
L4W 2T3
www.panasonic.ca

