

# DVD Stereo System

## Operating Instructions

Model No. **SC-VK90D**  
**SC-VK80D**  
**SC-VK70D**



The above illustration of the unit is an example and shows SC-VK90D for Southeast Asia.



# Panasonic

## Region number supported by this player

Region numbers are allocated to DVD players and software according to where they are sold.

### For the Middle East and South Africa

- The region number of this player is "2".
- The player will play DVD-Video marked with labels containing "2" or "ALL".

Example:



### For Southeast Asia

- The region number of this player is "3".
- The player will play DVD-Video marked with labels containing "3" or "ALL".

Example:



### For Australia, N.Z. and Oceania

- The region number of this player is "4".
- The player will play DVD-Video marked with labels containing "4" or "ALL".

Example:



Before connecting, operating or adjusting this product, please read these instructions completely. Please keep this manual for future reference.

**Dear customer**

Thank you for purchasing this product.

For optimum performance and safety, please read these instructions carefully.

**VK90D** : indicates features applicable to SC-VK90D only.

**VK80D** : SC-VK80D only.

**VK70D** : SC-VK70D only.

- These operating instructions are applicable to models SC-VK90D, SC-VK80D and SC-VK70D for a variety regions.
- Unless otherwise indicated, illustrations in these operating instructions are of SC-VK90D for Southeast Asia.

Getting started

System	SC-VK90D	SC-VK80D	SC-VK70D
Main unit	SA-VK90D	SA-VK80D	SA-VK70D
Front speakers	SB-VK90	SB-VK80	SB-VK70
Center speaker	SB-PC810	SB-PC810	----
Surround speakers	SB-PS810	SB-PS810	SB-PS810
Subwoofer	SB-WVK80 (2 units)	SB-WVK80 (1 unit)	----

**CAUTION!**

THIS PRODUCT UTILIZES A LASER.

USE OF CONTROLS OR ADJUSTMENTS OR PERFORMANCE OF PROCEDURES OTHER THAN THOSE SPECIFIED HEREIN MAY RESULT IN HAZARDOUS RADIATION EXPOSURE.

DO NOT OPEN COVERS AND DO NOT REPAIR YOURSELF. REFER SERVICING TO QUALIFIED PERSONNEL.

**WARNING:**

TO REDUCE THE RISK OF FIRE, ELECTRIC SHOCK OR PRODUCT DAMAGE, DO NOT EXPOSE THIS APPARATUS TO RAIN, MOISTURE, DRIPPING OR SPLASHING AND THAT NO OBJECTS FILLED WITH LIQUIDS, SUCH AS VASES, SHALL BE PLACED ON THE APPARATUS.

**CAUTION!**

- DO NOT INSTALL OR PLACE THIS UNIT IN A BOOKCASE, BUILT-IN CABINET OR IN ANOTHER CONFINED SPACE. ENSURE THE UNIT IS WELL VENTILATED. TO PREVENT RISK OF ELECTRIC SHOCK OR FIRE HAZARD DUE TO OVERHEATING, ENSURE THAT CURTAINS AND ANY OTHER MATERIALS DO NOT OBSTRUCT THE VENTILATION VENTS.
- DO NOT OBSTRUCT THE UNIT'S VENTILATION OPENINGS WITH NEWSPAPERS, TABLECLOTHS, CURTAINS, AND SIMILAR ITEMS.
- DO NOT PLACE SOURCES OF NAKED FLAMES, SUCH AS LIGHTED CANDLES, ON THE UNIT.
- DISPOSE OF BATTERIES IN AN ENVIRONMENTALLY FRIENDLY MANNER.

The socket outlet shall be installed near the equipment and easily accessible or the mains plug or an appliance coupler shall remain readily operable.

This product may receive radio interference caused by mobile telephones during use. If such interference is apparent, please increase separation between the product and the mobile telephone.

**For the Middle East, South Africa and Southeast Asia****CAUTION:**

The AC voltage is different according to the area. Be sure to set the proper voltage in your area before use. (For details, please refer to page 7.)

<b>CAUTION</b>	- LASER RADIATION WHEN OPEN. DO NOT STARE INTO BEAM. FDA 21 CFR / Class II
<b>CAUTION</b>	- VISIBLE AND INVISIBLE LASER RADIATION WHEN OPEN. AVOID EXPOSURE TO BEAM. IEC60825-1 / Class 3b
<b>VARNING</b>	- SYNLLIG OCH OSYNLLIG LASERSTRÅLNING NÄR DENNA DEL ÄR ÖPPNAD. BETRÄKTA EJ STRÅLEN.
<b>ADVARSEL</b>	- SYNLLIG OG OSYNLLIG LASERSTRÅLNING VED ÅBNING. UNNGÅ UDSÆTTELSE FOR STRÅLING.
<b>ADVARSEL</b>	- SYNLLIG OG OSYNLLIG LASERSTRÅLNING NÄR DEKSEL ÅPNET. UNNGÅ EKSPOSERING FOR STRÅLEN.
<b>VARO!</b>	- AVATTAESSA OLET ALTBINA NÄKYVÄÄ JA NÄKYMÄTÖN LASERSÄTELYLLE. ÄLÄ KATSO SÄTEESSEEN.
<b>VORSICHT</b>	- SICHTBARE UND UNSICHTBARE LASERSTRAHLUNG, WENN ABDECKUNG GEÖFFNET. NICHT DEM STRAHL AUSSETZEN.
<b>ATTENTION</b>	- RAYONNEMENT LASER VISIBLE ET INVISIBLE EN CAS D'OUVERTURE. EXPOSITION DANGEREUSE AU FASCICUL.
<b>注意</b>	- 打开时有可见及不可见激光辐射。避免激光照射。
<b>注意</b>	- ここを開くと可視及び不可視レーザー光が出ます。ビームを見たり、触れたりしないで下さい。 ROLXS0054

(Inside of product)

**CLASS 1  
LASER PRODUCT**

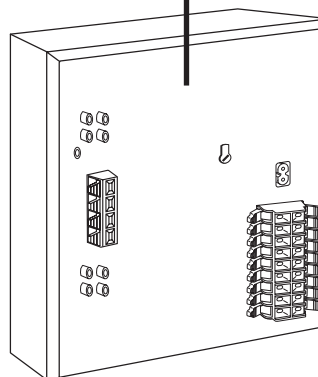
**For the Middle East, South Africa and Southeast Asia**

THIS UNIT IS INTENDED FOR USE IN TROPICAL CLIMATES.

**For Australia, N.Z. and Oceania**

THIS UNIT IS INTENDED FOR USE IN MODERATE CLIMATES. [www.DataSheet4U.com](http://www.DataSheet4U.com)

## Getting started

**Accessories** ..... 3  
**Glossary** ..... 4  
**Disc information** ..... 5

**Simple setup**

**STEP1** Locating ..... 6  
**STEP2** Connecting the speakers and voltage selection ..... 7  
**STEP3** Television ..... 8  
**STEP4** Connecting the antennas and AC power supply cord ..... 9  
**STEP5** The remote control ..... 9  
**STEP6** QUICK SETUP ..... 10  
**STEP7** Setting the time ..... 11  
 Turning DEMO off ..... 11

**Control reference guide** ..... 12

## Disc operations

**Discs—Basic play** ..... 14

Normal play ..... 14  
 Position Memory function ..... 15  
 Starting play from a selected item ..... 15  
 Selecting still pictures—Page skip ..... 15  
 Skipping items/Fast forward and rewind—SEARCH ..... 15  
 Slow-motion play/Frame-by-frame viewing ..... 15  
 Replaying a scene—QUICK REPLAY ..... 15

**Discs—Convenient functions** ..... 16

Disc play mode function/Selecting groups and tracks to play ... 16  
 All group play/Random play/Program play ..... 17  
 Soundtracks/Subtitles/Repeat play ..... 18  
 A-B repeat play ..... 19  
 Marking places to play again/Variable Zoom function ..... 19

**Playing the programs or play list on DVD-RAM** ..... 20

Selecting a program to play—DIRECT NAVIGATOR ..... 20  
 Using the play list menu ..... 20

**WMA/MP3, CD text and JPEG navigation menus** ..... 21

Playing HighMAT discs ..... 22

**Using GUI (Graphical User Interface) screens** ..... 23

Common procedures/Progress indicator ..... 23  
 Disc information/Unit information ..... 24

## Radio operations

**The radio** ..... 26

Manual tuning/Preset tuning ..... 26  
 Selecting channels ..... 26

## Tape operations

**Cassette tapes** ..... 27

## Sound field/sound quality operations

**Sound field** ..... 28

Dolby Digital and DTS/Dolby Pro Logic ..... 28  
 Speaker level adjustments ..... 28  
 Super Surround/Advanced Surround ..... 29  
 Center Focus/Seat Position ..... 29  
 Custom Sound Memory—Store the sound settings ..... 29

**Sound quality** ..... 30

Double re-master—Enjoying more natural sound ..... 30  
 Changing sound field and quality ..... 30  
 Using the Manual Equalizer (MANUAL EQ)/  
 Using the Super Sound Equalizer/Adjusting the bass ..... 30

## Recording operations

**Recording** ..... 31

## Karaoke operations

(For the Middle East, South Africa and Southeast Asia)

**Enjoying karaoke** ..... 32

Enjoying karaoke with karaoke DVD ..... 32  
 Enjoying karaoke with other karaoke sources ..... 33  
 Changing the key/Adding an echo effect/To record your  
 karaoke performance/To record your voice ..... 33

## Timer operations

**Using the timers** ..... 34

The play/record timer/The sleep timer ..... 34

## Other functions

**Convenient functions** ..... 35

Changing the sound range display ..... 35  
 Muting the volume/Dimming the display/  
 Auto-off function ..... 35  
 Using headphones/Operating a television ..... 35

**Changing settings** ..... 36

Common procedures/Entering a password (Ratings) ..... 37  
 Changing the delay time (Speaker Setting) ..... 37  
 Digital output/Optional antenna connections ..... 38

**Using other equipment** ..... 39

Home Theater—Enjoying more powerful sound ..... 39  
 Using an external unit ..... 39

## Reference

**Troubleshooting guide** ..... 40  
**Safety precautions/Maintenance** ..... 42  
**Specifications** ..... 43

## Accessories

 Please check and identify the supplied accessories.

- AC power supply cord ... 1 pc.  Power plug adaptor .... 1 pc.
- For the Middle East, South Africa and Southeast Asia** **For the Middle East, South Africa and Southeast Asia**

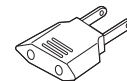
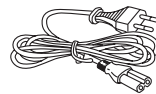

**For Australia, N.Z. and Oceania**

- AM loop antenna ..... 1 pc.



- Video cable ..... 1 pc.  FM indoor antenna .... 1 pc.



- Remote control ..... 1 pc.  Batteries for remote control ..... 2 pcs.

**For the Middle East, South Africa and Southeast Asia**

**VK90D VK80D**  
(N2QAJB000076)

**VK70D**  
(N2QAJB000077)

**For Australia, N.Z. and Oceania**

**VK90D VK80D**  
(N2QAJB000083)

**VK70D**  
(N2QAJB000082)

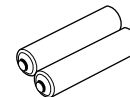

**Note**

The included AC power supply cord is for use with this unit only. Do not use it with other equipment.

## Decoder

A decoder restores the coded audio signals on DVDs to normal. This is called decoding.

## Dolby Digital

This is a method of coding digital signals developed by Dolby Laboratories. Apart from stereo (2-channel) audio, these signals can also be multi-channel audio. A large amount of audio information can be recorded on one disc using this method.

## DTS (Digital Theater Systems)

This surround system is used in many movie theaters around the world. There is good separation between the channels, so realistic sound effects are possible.

## Dynamic range

Dynamic range is the difference between the lowest level of sound that can be heard above the noise of the equipment and the highest level of sound before distortion occurs.

## Film and video

DVD-Videos are recorded using either film or video. Usually, film is recorded at 24 frames per second, the rate movies are filmed at, while video is recorded at 30 frames per second.

## Frame still and field still

Frames are the still pictures that go together to make a moving picture. There are about 30 frames shown each second.

One frame is made up of two fields. A regular television shows these fields one after the other to create frames.

A still is shown when you pause a moving picture. A frame still is made up of two alternating fields, so the picture may appear blurred, but overall quality is high.

A field still is not blurred, but it has only half the information of a frame still so picture quality is lower.

## Interlace

NTSC, the video signal standard, has 480 interlaced (I) scan lines. The video signals output from this unit's COMPONENT VIDEO OUT terminals (Y, Pb, Pr) allow you to enjoy higher quality pictures than if the signals were output from the VIDEO OUT terminal or S VIDEO OUT terminal.

## I/P/B

MPEG 2, the video compression standard adopted for use with DVD-Video, codes frames using these 3 picture types.

### I: Intra coded picture

This picture has the best quality and is the best to use when adjusting the picture.

### P: Predictive coded picture

This picture is calculated based on past I or P-pictures.

### B: Bidirectionally-predictive coded picture

This picture is calculated by comparing past and future I and P-pictures so it has the lowest volume of information.

## Linear PCM (pulse code modulation)

These are uncompressed digital signals, similar to those found on CDs.

## Playback control (PBC)

If a Video CD has playback control, you can select scenes and information with menus.

## WMA, MP3, CD text and JPEG information

- Discs must conform to ISO9660 level 1 or 2 (except for extended formats).
- This unit is compatible with multi-session but if there are a lot of sessions it takes more time for play to start. Keep the number of sessions to a minimum to avoid this.
- The order tracks appear in the menus may differ to the order shown on your computer.

### WMA

- Noise may occur when playing WMA files.
- You cannot play WMA files that are copy protected.

### MP3

- This unit is not compatible with ID3 tags.
- If you play an MP3 track that includes still picture data, it will take some time before the music itself starts playing and the elapsed time will not be displayed during this time. Even after the track starts, the correct play time will not be displayed.

### JPEG

- To view JPEG files on this unit:
  - Take them on a digital camera that meets the DCF (Design rule for Camera File System) standard. Some digital cameras have functions that are not supported by the DCF standard like automatic picture rotation which may render a picture unviewable.
  - Do not alter the files in any way or save them under a different name.
- This unit cannot display moving pictures, Motion JPEG and other such formats, still pictures other than JPEG (i.e. TIFF) or play associated sound.

## Order of play

WMA | MP3 | JPEG

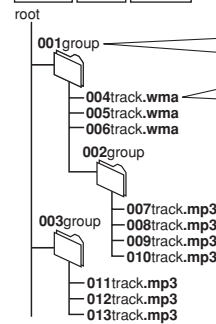

### Naming folders and files

Prefix folder and file names with 3-digit numbers in the order you want to play them.

Extension  
004track.wma (or .WMA)

The extension for MP3 is ".mp3" or ".MP3".

The extension for JPEG is ".JPG", ".jpg", ".JPEG" or ".jpeg".

### CD (CD text only)

#### When making your own CD text discs

The unit plays the tracks in the order you record them so you do not have to prefix the titles with numbers.



Windows Media, and the Windows logo are trademarks, or registered trademarks of Microsoft Corporation in the United States and/or other countries.

WMA is a compression format developed by Microsoft Corporation. It achieves the same sound quality as MP3 with a file size that is smaller than that of MP3.



MPEG Layer-3 audio decoding technology licensed from Fraunhofer IIS and Thomson multimedia.

## ■ Discs that can be played

Disc type	Logo	Indication used in instructions
DVD-RAM		<b>RAM</b>
DVD-Audio		<b>DVD-A</b>
DVD-Video		<b>DVD-V</b>
DVD-R		
Video CD		<b>VCD</b> Including SVCD (Conforming to IEC62107)
CD		<b>CD</b> Including CD text
CD-R/RW	—	<b>WMA MP3</b> <b>JPEG</b>

- Use discs with the above logos and that conform to specifications. The unit cannot play other discs correctly.
- Do not use irregularly shaped discs (e.g. heart-shaped), as these can damage the unit.

## ■ Discs that cannot be played

DVD-ROM, CD-ROM, CDV, CD-G, +RW, DVD-RW, CVD, SACD, Divx Video Discs, Photo CD and “Chaoji VCD” available on the market including CVD, DVCD and SVCD that do not conform to IEC62107.

## ■ Disc structure

Disc structure and the labels given to the items on discs depend on the disc type.

- Track:** the smallest division on DVD-Audio, CDs and Video CDs, or a single WMA/MP3 file.
- Chapter:** the smallest division on DVD-Video.
- Group:** collections of tracks on DVD-Audio and equivalent to folders or albums on data discs.
- Title:** the largest division on DVD-Video, usually an entire movie.
- Program:** the division on DVD-RAM equivalent to a single recording.
- Picture:** a single JPEG file.
- Play list:** the largest grouping on a HighMAT disc, or a group of scenes on DVD-RAM.
- Scene:** DVD-RAM program sections specified and grouped into play lists on a DVD video recorder.
- Content:** covers tracks and pictures on HighMAT discs.

### Playing DVDs and Video CDs

The producer of these discs can control how they are played so you may not always be able to control play as described in these operating instructions (for example if the play time is not displayed or if a Video CD has menus). Read the disc's instructions carefully.

## ■ DVD-RAM discs

DVD-RAM discs must meet the following conditions for this unit to be able to play them.

Type	<ul style="list-style-type: none"> <li>• Non-cartridge discs</li> <li>• Discs that can be removed from their cartridges (TYPE 2 and 4)</li> </ul>
Capacity	<ul style="list-style-type: none"> <li>• 12 cm 9.4 GB (double-sided) and 4.7 GB (single-sided)</li> <li>• 8 cm 2.8 GB (double-sided)</li> </ul>
Recording format	Discs recorded with DVD video recorders, DVD video cameras, personal computers, etc., using Version 1.1 of the Video Recording Format (a unified video recording standard).

- Remove TYPE 2 and 4 discs from their cartridges before use, then return them when you are finished. Read the instructions for the disc carefully.
- Do not allow the disc to become dirty or scratched. Store discs in their cartridges and ensure the disc label and cartridge label face the same way.
- Some parts of the disc, for example where one program ends and another begins, may not play smoothly.

## ■ DVD-R discs

Panasonic DVD-R recorded and finalized on a Panasonic DVD video recorder are played as DVD-Video on this unit.

## ■ CD-R and CD-RW discs

This unit can play CD-R/RW (audio recording disc) recorded with CD-DA, video CD, SVCD (conforming to IEC62107), WMA, MP3 or JPEG. Close the sessions or finalize the disc after recording.

## ■ HighMAT discs

This unit is compatible with HighMAT discs containing WMA, MP3, and/or JPEG files.

### Note

It may not be possible to play CD-R, CD-RW, DVD-R and DVD-RAM in all cases due to the type of disc or condition of the recording.

## ■ Video systems

This unit can play both the PAL and NTSC for video systems. To view PAL or NTSC, however, your television must match the system used on the disc.

PAL discs cannot be correctly viewed on an NTSC television. NTSC can be correctly viewed on a PAL television by converting the video signal to PAL 60 (→ page 36, Video—NTSC Disc Output).

## ■ To clean discs

### DVD-Audio, DVD-Video, Video CD, CD

Wipe with a damp cloth and then wipe dry.



### DVD-RAM, DVD-R

- Clean with an optional DVD-RAM/PD disc cleaner (LF-K200DCA1, where available).
- Never use cloths or cleaners for CDs etc.

## ■ Handling precautions

- Do not write on the label side with a ball-point pen or other writing instrument.
- Do not use record cleaning sprays, benzene, thinner, static electricity prevention liquids or any other solvent.
- Do not attach labels or stickers to discs. (Do not use discs with exposed adhesive from tape or left over peeled-off stickers.)
- Do not use scratch-proof protectors or covers.
- Do not use discs printed with label printers available on the market.

# Simple setup

## STEP 1 Locating

Optimum location  
Distance: A=B=C=D=E

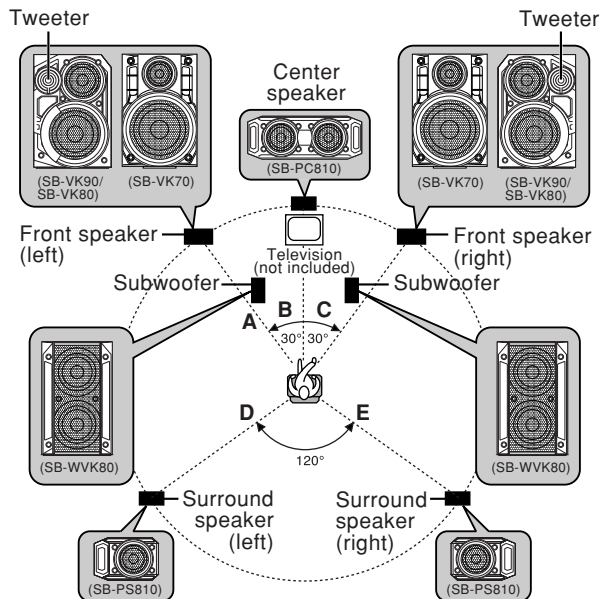

### Attaching to a wall

Surround and center speakers can be attached to walls. Set the speaker onto screws (not included) and slide through bracket to lock into position.

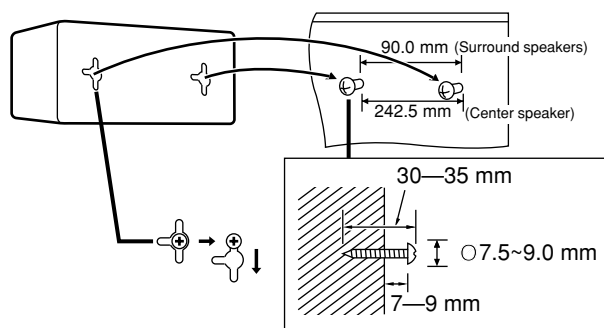

#### Note

- The wall or pillar on which the speakers are to be attached should be capable of supporting 10 kg per screw.
- You cannot take the front net off the speakers.

#### Caution

- Use the speakers only with the recommended system. Failure to do so may lead to damage to the amplifier and/or the speakers, and may result in the risk of fire. Consult a qualified service person if damage has occurred or if you experience a sudden change in performance.
- Do not attempt to attach these speakers to walls using methods other than those described in this manual.

### Front speakers

**VK90D VK80D**

Place the speakers so that the tweeter is on the outside.

**VK70D**

Speakers are designed identically so that no left or right channel orientation is necessary.

### Center speaker **VK90D VK80D**

- You can also put this speaker directly under the television.
- Vibration caused by the center speaker can disrupt the picture if it is placed directly on the television. Put the center speaker on a rack or shelf.

### Surround speakers

The small speakers with the long cords are surround speakers. Place on either side of listening position, or slightly to the rear, about 1 meter higher than ear level with the Panasonic logo facing towards the listening position.

The effect varies with the type of music and music source.

### Subwoofer **VK90D VK80D**

Place to the right and left (**VK90D**) or right (**VK80D**) of the television, on the floor or a sturdy shelf so that it won't cause vibration.

Leave 10 cm at the rear for ventilation.

### • Use only supplied speakers

- Using other speakers can damage the unit and sound quality will be negatively affected.
- Set the speakers up on an even surface to prevent them from falling. Take proper precautions to prevent the speakers from falling if you cannot set them up on an even surface.

#### Note

The angles in the diagram are approximate.

### Positioning for best effect

How you set up your speakers can affect the bass and the sound field. Note the following points.

- Place speakers on flat secure bases.
- Placing speakers too close to floors, walls, and corners can result in excessive bass. Cover walls and windows with a thick curtain.
- Keep your speakers at least 10 mm away from the system for proper ventilation.

### Notes on speaker use

- You can damage your speakers and shorten their useful life if you play sound at high levels over extended periods.
- Reduce the volume in the following cases to avoid damage.
  - When playing distorted sound.
  - When the speakers emit strange noise (howling) from a microphone or record player, noise from FM broadcasts, or continuous signals from an oscillator, test disc, or electronic instrument.
  - When adjusting the sound quality.
  - When turning the unit on or off.

### If irregular coloring occurs on your television

These speakers are designed to be used close to a television, but the picture may be affected with some televisions and set-up combinations.

**If this occurs, turn the television off for about 30 minutes.**

The television's demagnetizing function should correct the problem. If it persists, move the speakers further away from the television.

# STEP 2 Connecting the speakers and voltage selection

Twist and pull off the vinyl tip of the speaker cords.



**For the Middle East, South Africa and Southeast Asia**

**Before connecting the AC power supply cord, set the voltage.**

**Voltage Selector**  
Use a flat-head screwdriver to turn the voltage selector on the rear panel to the appropriate position for the area in which this system is used.  
If the power supply in your area is 115 V or 120 V, please set the voltage selector as follows:

- For 115 V: Set to 110 V.
- For 120 V: Set to 127 V.

**VOLT ADJ**

127 V ↔ 110 V ↔ 220-230 V ↔ 240 V

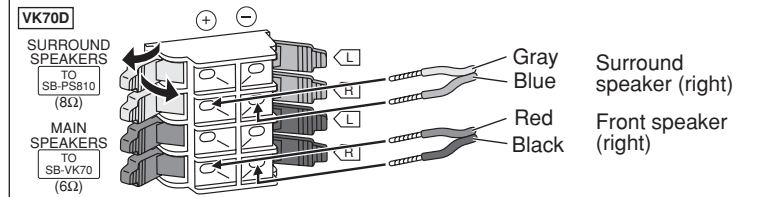
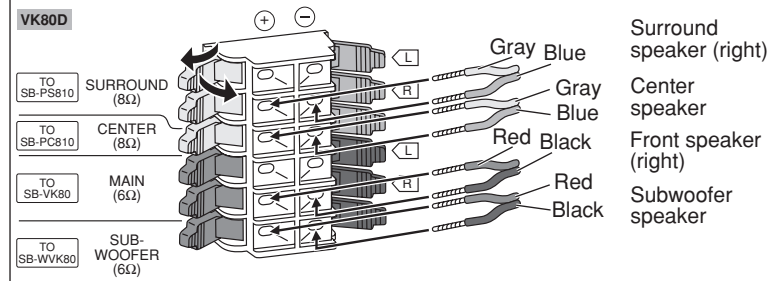
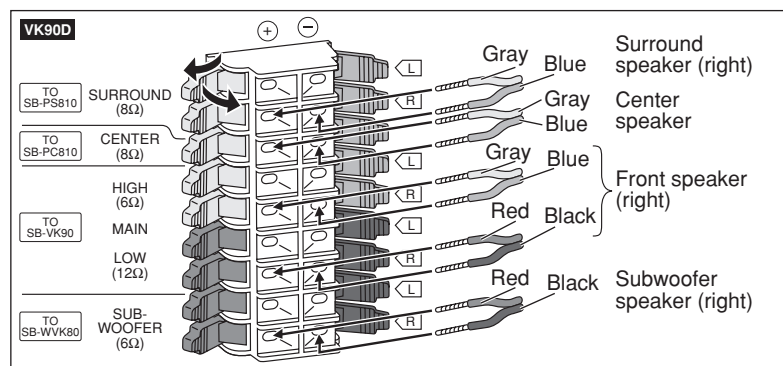
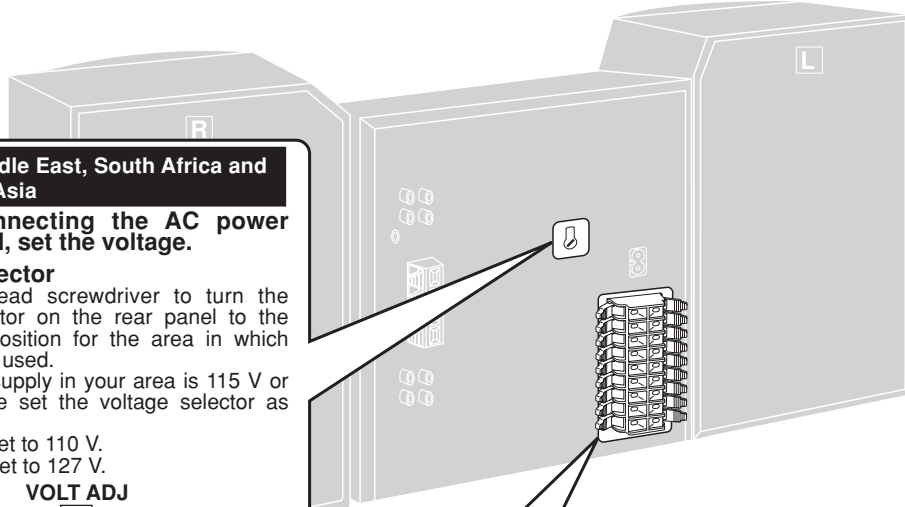

Connect the left (L) side in the same way.

# STEP 3 Television

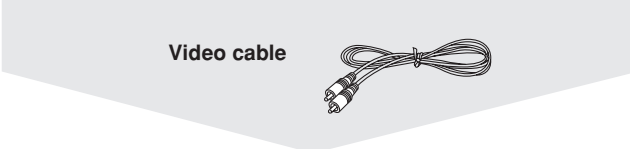

## ■ Connecting a television with a VIDEO IN terminal

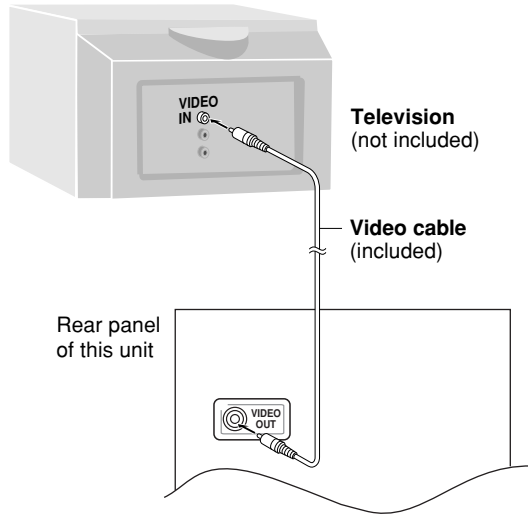

### Connect directly to your television.

Do not connect the unit through a video cassette recorder, because the picture may not be played correctly due to the copy guard.

## ■ Connecting a television with COMPONENT VIDEO IN terminals

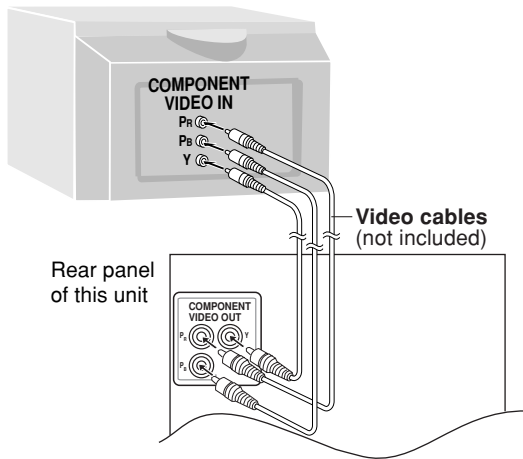

### COMPONENT VIDEO OUT terminals

These terminals can be used for Interlace provide a purer picture than the S VIDEO OUT terminal. Connection using these terminals outputs the color difference signals (P<sub>B</sub>/P<sub>R</sub>) and luminance signal (Y) separately in order to achieve high fidelity in reproducing colors. The description of the component video input terminals depends on the television or monitor (e.g. Y/P<sub>B</sub>/P<sub>R</sub>, Y/B-Y/R-Y, Y/C<sub>B</sub>/C<sub>R</sub>). Connect to terminals of the same color.

## ■ Connecting a television with an S VIDEO IN terminal

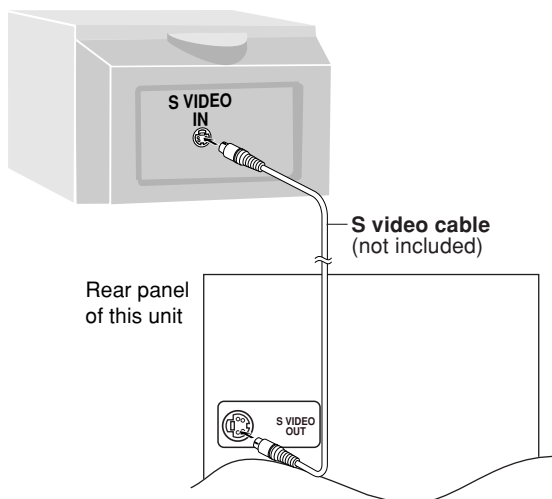

### S VIDEO OUT terminal

The S video terminal achieves a more vivid picture than the VIDEO OUT terminal by separating the chrominance (C) and luminance (Y) signals. (Actual results depend on the television.)



# STEP 4 Connecting the antennas and AC power supply cord

Simple setup

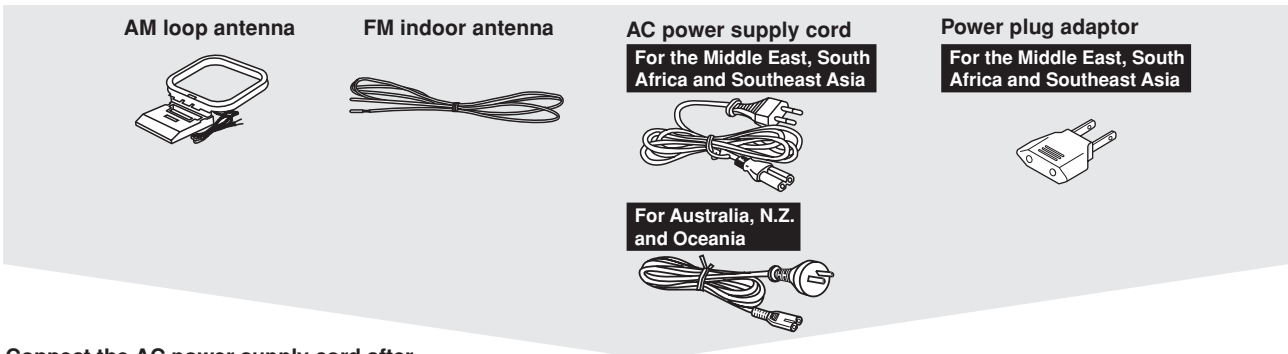

Connect the AC power supply cord after all other connections are complete.

**AM loop antenna**  
Stand the antenna up on its base.  
Keep loose antenna cord away from other wires and cords.

**FM indoor antenna**  
Fix the other end of the antenna where reception is best.

**Conserving power**

The unit consumes power (approx. 0.9W) even when it is turned off with [⏻/⏻] (remote control: [⏻]). To save power when the unit is not to be used for a long time, unplug it from the household AC power socket. Remember to reset the radio stations and any other memory items before using the unit again.  
Information you enter into the unit's memory remains intact for up to 2 weeks after the AC power supply cord is disconnected.

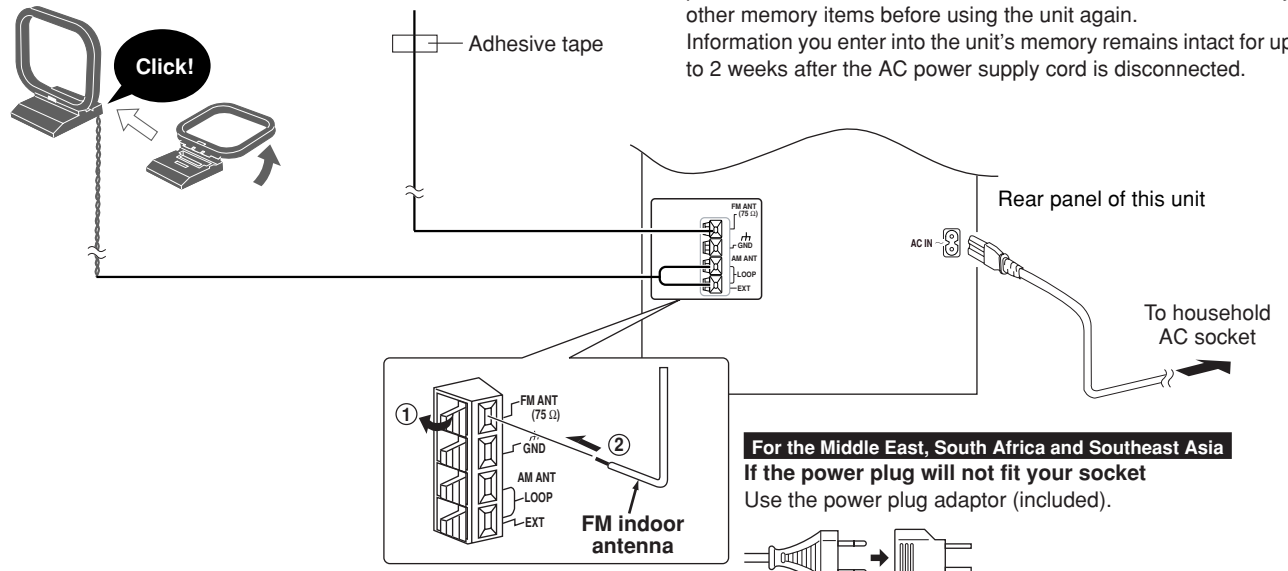

# STEP 5 The remote control

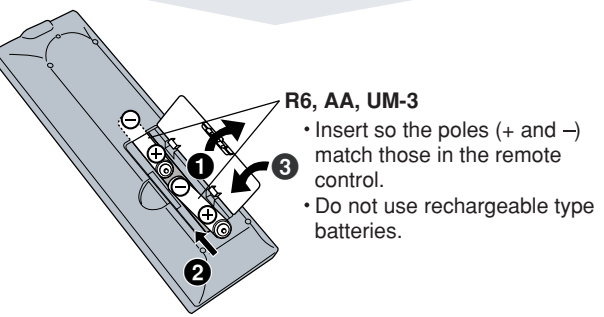
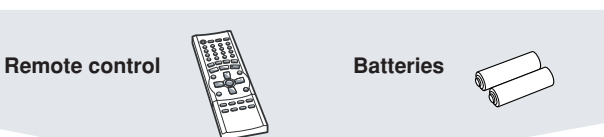

**R6, AA, UM-3**

- Insert so the poles (+ and -) match those in the remote control.
- Do not use rechargeable type batteries.

**Do not;**

- mix old and new batteries.
  - use different types at the same time.
  - heat or expose to flame.
  - take apart or short circuit.
  - attempt to recharge alkaline or manganese batteries.
  - use batteries if the covering has been peeled off.
- Mishandling of batteries can cause electrolyte leakage which can damage items the fluid contacts and may cause a fire.

Remove if the remote control is not going to be used for a long period of time. Store in a cool, dark place.

**■ Use**

Aim at the sensor, avoiding obstacles, at a maximum range of 7m directly in front of the unit.

# STEP 6 QUICK SETUP

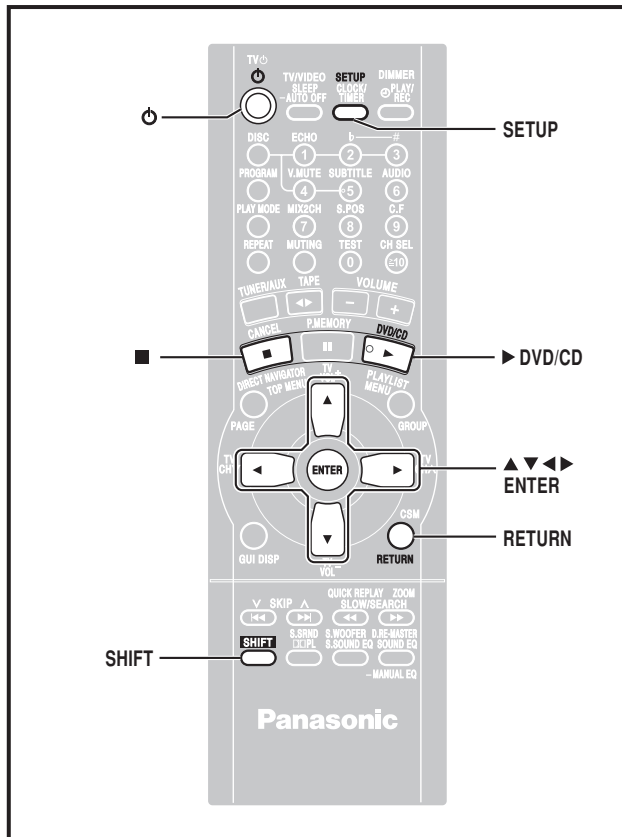

The **QUICK SETUP** screen appears when you press [SHIFT]+[SETUP] the first time after purchase and assists you to make necessary settings. You can access this screen again later if you need to (⇒ page 36, Others—QUICK SETUP).

## Preparation

Turn on the television and select the appropriate video input on the television to suit the connections for the unit.

## To return to the previous screen

Press [RETURN].

## ■ TV TYPE

Select to suit the type of television.

- **Standard (Direct View TV)** (factory preset)
- **CRT Projector**
- **LCD TV/Projector**
- **Projection TV**
- **Plasma TV**

- 1 Press [TV/VIDEO] to turn on the unit.
- 2 Press [DVD/CD] to select “DVD/CD” as the source.  
Press [■] when a disc is in the tray.
- 3 Press [SHIFT]+[SETUP] to show the QUICK SETUP screen.  
e.g. **For Southeast Asia**

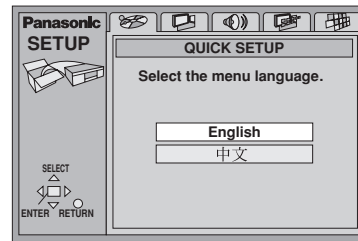

- 4 Press [▲, ▼, ◀, ▶] to select the menu language and press [ENTER].
- 5 Press [▲, ▼] to select “Yes” to continue and press [ENTER].
- 6 Press [▲, ▼, ◀, ▶] to select the item and press [ENTER].
  - Audio Language (⇒ page 37)
  - Subtitle Language (⇒ page 37)
  - TV Type (⇒ below)
  - TV Aspect (⇒ below)
  - PCM Digital Output (VK70D) (⇒ page 38)
- 7 Press [ENTER] and then [SHIFT]+[SETUP] to end the settings.

## ■ TV Aspect

Select “4:3” (regular) or “16:9” (widescreen) to suit your television. If you have a regular 4:3 television, you can also select how video on some discs is shown (⇒ page 36, Video—TV Aspect).

- **4:3 Pan&Scan** (factory preset)

Widescreen software is expanded to fill the screen of a 4:3 aspect television (unless prohibited by the producer of the disc).



- **4:3 Letterbox**

Widescreen software is shown in the letterbox style on a 4:3 aspect television.



# STEP 7 Setting the time

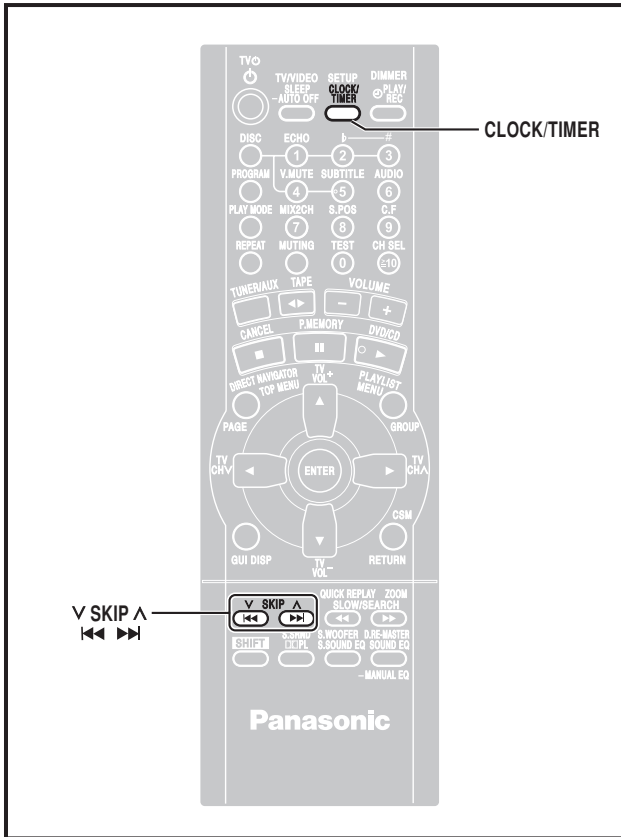

This is a 24-hour clock.

**1 Press [CLOCK/TIMER] to select “CLOCK”.**

Every time you press the button:

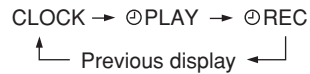

**2 (within 7 seconds or so)**

Press [**◀◀**, **▶▶**] or [**◀**, **▶**] to set the time.

**3 Press [CLOCK/TIMER] to finish setting the time.**

The display will return to whatever was displayed before you set the time.

**To display the time**

Press [CLOCK/TIMER] once when the unit is on or at standby mode.

The time is shown for about 5 seconds.

**Note**

Reset the clock regularly to maintain accuracy.

## Turning DEMO off

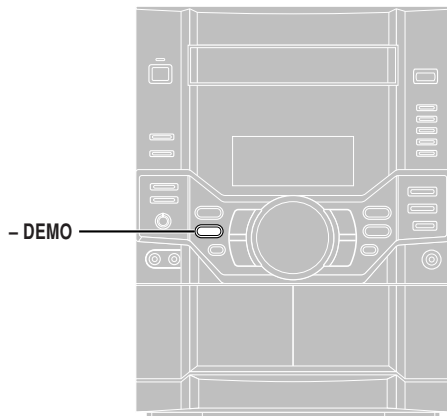

A demonstration of the display is shown in standby mode if you have not set the clock.

You can reduce the power consumed in standby mode by turning the demonstration off.

**While the DEMO display is shown**

Press and hold [**-DEMO**] until “NO DEMO” is displayed.

Every time you hold down the button:  
NO DEMO (off) ↔ DEMO ON (on)

**To show a demonstration of the display**

Hold down [**-DEMO**] until “DEMO ON” is displayed.

## Main unit

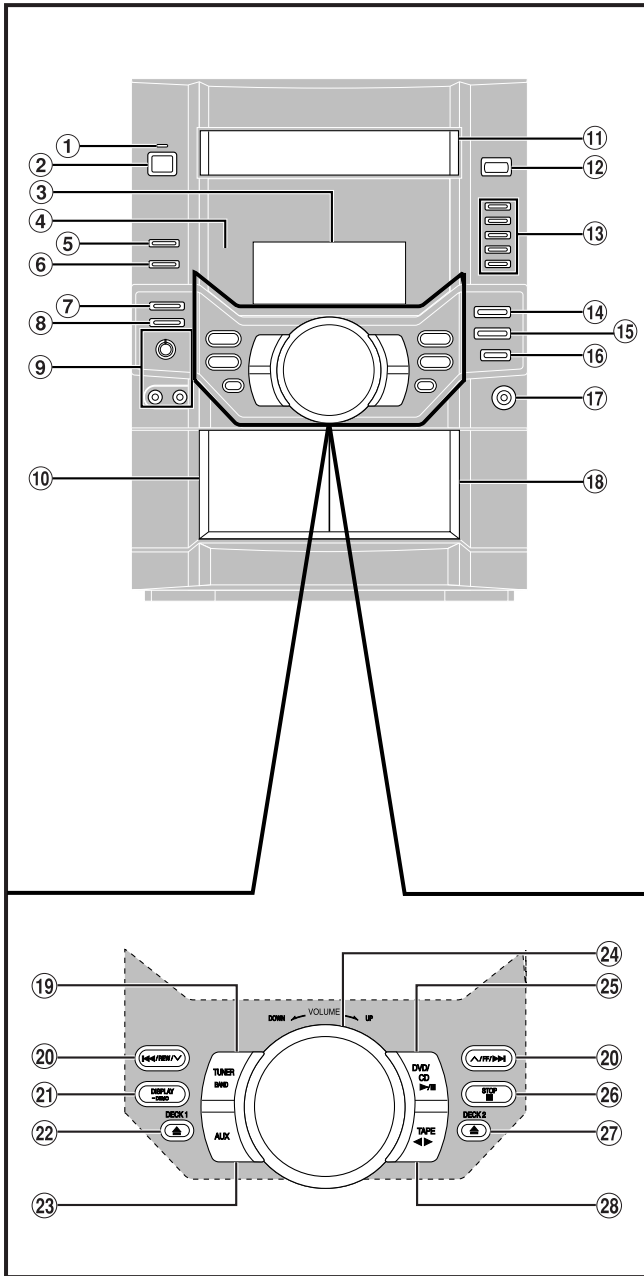

- ① **AC supply indicator [AC IN]**  
This indicator lights when the unit is connected to the AC mains supply.
- ② **Standby/on switch [⏻/⏻]**  
Press to switch the unit from on to standby mode or vice versa. In standby mode, the unit is still consuming a small amount of power.
- ③ **Display**
- ④ **Remote control signal sensor**
- ⑤ **Double re-master button [DOUBLE RE-MASTER] ..... 30**
- ⑥ **VK90D VK80D Super surround button [SUPER SURROUND] ..... 29**  
**VK70D Advanced surround button [ADVANCED SURROUND] ..... 29**
- ⑦ **Deck 1/2 selection button [DECK 1/2] ..... 27**
- ⑧ **Record button [● REC] ..... 31**
- ⑨ **For the Middle East, South Africa and Southeast Asia**  
**Microphone volume control [MIC VOL MIN, MAX] ..... 32**  
**Microphone jacks [MIC 1, 2] ..... 32**
- ⑩ **Deck 1 cassette holder ..... 27**
- ⑪ **Disc tray**
- ⑫ **Disc tray open/close button [▲ OPEN/CLOSE] ..... 14**
- ⑬ **Disc direct play buttons [1]–[5] ..... 14**
- ⑭ **Super sound EQ button [SUPER SOUND EQ] ..... 30**
- ⑮ **VK90D VK80D Subwoofer button [SUBWOOFER] ..... 30**
- ⑯ **Sound EQ button [SOUND EQ] ..... 30**
- ⑰ **Headphones jack [PHONES] ..... 35**
- ⑱ **Deck 2 cassette holder ..... 27**

## Center console

- ⑲ **Tuner/band select button [TUNER BAND] ..... 26**
- ⑳ **Disc skip/search/slow-motion play, tape fast-forward/rewind, tune/preset channel select, time adjust buttons [◀◀/REW/V, ^/FF/▶▶] ..... 15, 26, 27**
- ㉑ **Display, demonstration button [DISPLAY, –DEMO] ..... 11, 35**
- ㉒ **Deck 1 open button [▲ DECK 1] ..... 27**
- ㉓ **AUX button [AUX] ..... 39**
- ㉔ **Volume control [VOLUME DOWN, UP] ..... 14**
- ㉕ **DVD/CD play/pause button [▶/|| DVD/CD] ..... 14**
- ㉖ **Stop button [■ STOP] ..... 14**
- ㉗ **Deck 2 open button [▲ DECK 2] ..... 27**
- ㉘ **Tape play/direction button [◀▶ TAPE] ..... 27**

Remote control

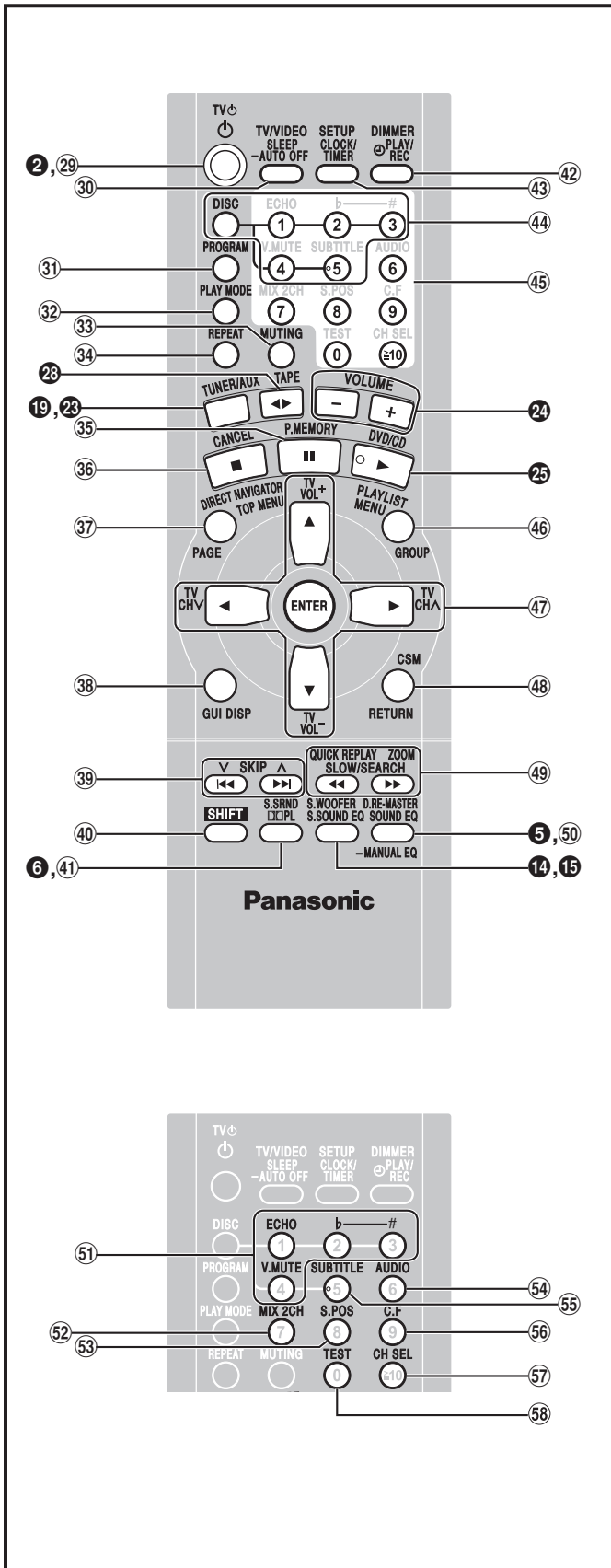

Buttons such as 2 function in exactly the same way as the buttons on the main unit.

- 29 TV power on/off button [TV ⏻] ..... 35
- 30 Sleep timer, Auto off, TV/Video input mode select button [SLEEP, -AUTO OFF, TV/VIDEO] ..... 34, 35
- 31 Program button [PROGRAM] ..... 17, 26
- 32 Play mode select button [PLAY MODE] ..... 16, 26, 27, 31
- 33 Muting button [MUTING] ..... 35
- 34 Repeat button [REPEAT] ..... 18
- 35 Pause, Position memory button [II, P. MEMORY] ..... 14, 15
- 36 Stop, Cancel button [■, CANCEL] ..... 14, 19, 37
- 37 Top menu, Direct navigator, Page button [TOP MENU, DIRECT NAVIGATOR, PAGE] ..... 14, 15, 20, 21
- 38 GUI display button [GUI DISP] ..... 19, 23
- 39 Disc skip, tape fast-forward/rewind, preset channel select, time adjust buttons [◀◀, ▶▶, √ SKIP ^] .... 11, 15, 26, 27
- 40 Shift button [SHIFT]  
To use functions labeled in orange:  
While pressing [SHIFT], press the corresponding button.
- 41 **VK90D VK80D** Dolby Pro Logic, Super Surround button [DPL, S. SRND] ..... 28, 29
- 42 Play timer/record timer, Dimmer button [⌚PLAY/REC, DIMMER] ..... 34, 35
- 43 Clock/timer, Setup button [CLOCK/TIMER, SETUP] ..... 10, 11, 37
- 44 Disc select button [DISC], Disc button [1] – [5] ..... 14
- 45 Numbered buttons [0 – 9, ≥10] ..... 14
- 46 Menu, Playlist, Group button [MENU, PLAYLIST, GROUP] ..... 14, 16, 20
- 47 Cursor buttons [▲, ▼, ◀, ▶], Enter button [ENTER] ..... 14  
These buttons have the following functions.  
[▲, ▼] : TV volume buttons [TV VOL +, -] ..... 35  
[◀, ▶] : TV channel select buttons [TV CH ^, √] ..... 35
- 48 Return, Custom sound memory button [RETURN, CSM] ..... 14, 29
- 49 Slow/search, Tuning buttons [◀◀, ▶▶ SLOW/SEARCH] ..... 15, 26  
These buttons have the following functions.  
[◀◀] : Quick replay button [QUICK REPLAY] ..... 15  
[▶▶] : Zoom button [ZOOM] ..... 19
- 50 Sound EQ, Manual EQ button [SOUND EQ, -MANUAL EQ] ..... 30
- 51 **For the Middle East, South Africa and Southeast Asia**  
Echo button [ECHO] ..... 33  
Key control buttons [b, #] ..... 33  
Vocal mute button [V. MUTE] ..... 32
- 52 **VK90D VK80D** 2 channel down-mixing button [MIX 2CH] ..... 28
- 53 **VK90D VK80D** Seat position button [S.POS] ..... 29
- 54 Audio button [AUDIO] ..... 18, 32
- 55 Subtitle button [SUBTITLE] ..... 18
- 56 **VK90D VK80D** Center focus button [C.F] ..... 29
- 57 **VK90D VK80D** Channel select button [CH SEL] ..... 29
- 58 **VK90D VK80D** Test signal button [TEST] ..... 28

Getting started



## Position Memory function

RAM DVD-A DVD-V VCD CD WMA MP3 JPEG

### During play

Press [SHIFT]+[P.MEMORY] to memorize a position.

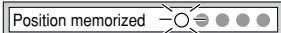

Press again to replace the position.

This position is saved even if you turn the unit off, change the source or change discs. When you turn the unit on, re-select "DVD/CD" or reinsert the disc whose position you memorized, "RESUME" lights on the display. Press [▶/|| DVD/CD] (remote control: [▶ DVD/CD]) to start play from the memorized position. The position is cleared.

- After changing the source or selecting another disc, re-selecting the disc tray with the memorized position automatically starts playback.
- You can memorize positions on up to five different discs at a time. When you memorize another position, the earliest position is replaced.

### Resume function

"RESUME" lights on the display when the unit has recorded the position at which you stopped play.

Press [▶/|| DVD/CD] (remote control: [▶ DVD/CD]) to start play from that position.

The position is cleared when you:

- Turn the unit off.
- Select another source or change discs.
- Press [■ STOP] (remote control: [■]) to clear the position.

### Chapter Review

#### DVD-V

The following message appears immediately after you press [▶/|| DVD/CD] (remote control: [▶ DVD/CD]) when "RESUME" is displayed.

Press PLAY to Preview Chapters

Press [▶/|| DVD/CD] (remote control: [▶ DVD/CD]) while the message is displayed and the beginning portions of each chapter up to the current one are played.

Full play resumes from the point where you pressed [■ STOP] (remote control: [■]) or [SHIFT]+[P.MEMORY]. (This feature works only within a title.)

If you do not press [▶/|| DVD/CD] (remote control: [▶ DVD/CD]), the message disappears and play starts from where you pressed [■ STOP] (remote control: [■]) or [SHIFT]+[P.MEMORY].

## Starting play from a selected item

RAM DVD-A DVD-V VCD CD WMA MP3 JPEG

### Remote control only

Press the numbered buttons to select the item.

Play starts from the selected item.

#### To select a 2-digit number

Example: To select item 23, press [≥10] → [2] → [3].

WMA MP3 JPEG [2] → [3] → [ENTER].

#### Note

- This works only when stopped with some discs.
- When playing DVD-Audio and you want to start play from a track in a different group, select the group first (→ page 16).

## Selecting still pictures—Page skip

#### DVD-A

### Remote control only

During play or while paused

Press [SHIFT]+[PAGE].

The page changes each time you press the button.

PAGE 1

## Skipping items

RAM DVD-A DVD-V VCD CD WMA MP3

### During play or while paused

Press [◀◀, √] or [▶▶, ^] on the remote control.

- Press [◀◀/REW/√] or [^/FF/▶▶] on the main unit.

#### JPEG

Press [◀] or [▶] (or [◀◀, √] or [▶▶, ^]) for picture skip, or [▲] or [▼] for group skip.

- Each press increases the number of skips.

Example RAM

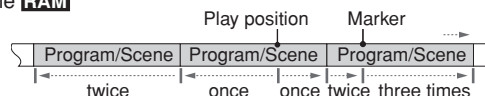

## Fast forward and rewind—SEARCH

RAM DVD-A DVD-V VCD CD WMA MP3

### During play

Press [◀◀] or [▶▶] on the remote control.

- Press and hold [◀◀/REW/√] or [^/FF/▶▶] on the main unit.
- Audio will be heard during search for most discs. You can turn this audio off if you want to (→ page 36, Audio—Audio during Search).
- DVD-V You can slow down or speed up play (→ page 23).

## Slow-motion play

RAM DVD-V VCD

DVD-A (Motion picture parts only)

### While paused

Press [◀◀] or [▶▶] on the remote control.

- Press and hold [◀◀/REW/√] or [^/FF/▶▶] on the main unit.

## Frame-by-frame viewing

RAM DVD-V VCD

DVD-A (Motion picture parts only)

### Remote control only

### While paused

Press [◀] or [▶].

The frame changes each time you press the button.

- The frames change in succession if you press and hold the button.
- Pressing [■] also activates forward frame-by-frame.

#### Note

- The speed of search and slow-motion increases up to 5 steps.
- Press [▶/|| DVD/CD] (remote control: [▶ DVD/CD]) to restart play.
- You cannot move backwards with Video CD during frame-by-frame and slow-motion.

### When playing Video CDs with playback control

Pressing buttons to perform skip, search or slow-motion may take you to a menu screen.

## Replaying a scene—QUICK REPLAY

RAM DVD-A DVD-V VCD CD WMA MP3

### Remote control only

Skip back a few seconds within the current item (program, track or title).

#### JPEG

Skip back a few pictures.

### During play

Press [SHIFT]+[QUICK REPLAY].

#### Note

This feature may not work while playing some parts of a disc or all with some discs.

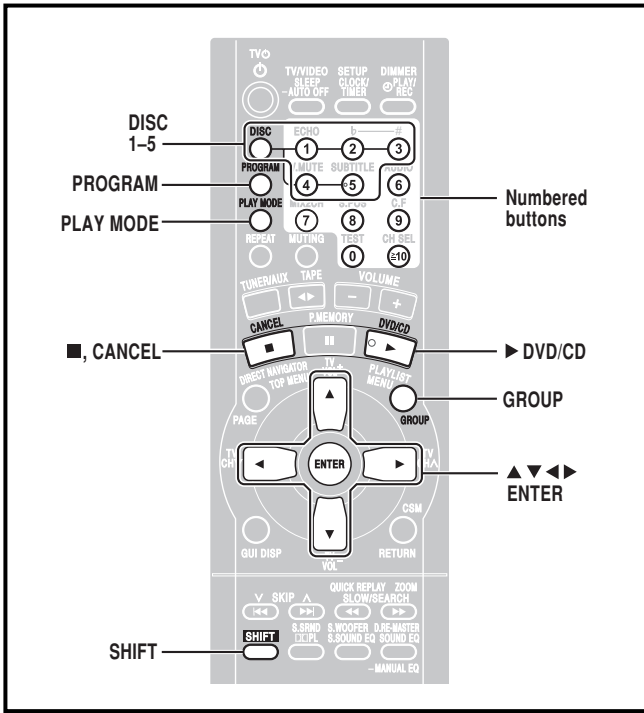

## Disc play mode function

VCD CD WMA MP3

**Preparation:** Press [▶ DVD/CD] and then [■].

**1 Press [PLAY MODE] to select the desired mode.**

VCD CD

Proceed to step 4 when you selected ALL DISC RANDOM in step 1.

**2 Press [DISC] and (within 10 seconds) [1]–[5] to select the disc.**

The disc starts.

**3 Only when you selected “1-SONG” in step 1 Select the track with the numbered buttons.**

To select a track 10 or over, press [≥10] then the two digits. Play starts from the selected track.

**4 Only when you selected “ALL DISC RANDOM” in step 1 Press [▶ DVD/CD] to start play.**

**To stop play**

Press [■].

**When playback ends**

The current play mode will be retained in memory until it is changed even if the unit is turned off.

※ **Final disc**

For example, if play starts from disc 4, disc 3 will be the “final disc”.

Order of progression: Disc 4→5→1→2→3

**Note**

- You can use repeat mode with disc play mode function.
- You cannot use program mode together with disc play mode function.

## Selecting groups and tracks to play

DVD-A WMA MP3 JPEG

**1 Press [SHIFT]+[GROUP].**

Example MP3



Track number in group  
Group number

**2 Press the numbered buttons to select the group and press [ENTER].**

**3 Press the numbered buttons to select the track/picture number and press [ENTER].**

DVD-A

**Playing all the groups in succession (⇒ Page 17, All group play)**

**Playing bonus groups**

Some discs contain bonus groups. If a password screen appears after selecting a group, enter the password with the numbered buttons. Refer also to the disc's jacket.

### Remote control only

DVD-A VCD CD WMA MP3

### Common procedures for selecting groups and tracks to play, all group and random play

**While stopped**  
Press [PLAY MODE].

Each time you press the button:

DVD-A

1-DISC → ALL-GROUP

WMA MP3

1-DISC → ALL-DISC → 1-SONG

1 DISC RANDOM

VCD CD

1-DISC → ALL-DISC → 1-SONG → 1 DISC RANDOM

ALL DISC RANDOM

DVD-A

If you select bonus groups, you will have to enter a password.

- ALL-DISC : Plays **all** loaded **discs** in succession from the selected disc to the final disc ※.
  - 1-SONG : Plays **one** selected **track** on the selected disc.
  - ALL-GROUP : Plays **all** **groups** in one disc.
  - 1 DISC RANDOM : Plays **one** selected **disc** in **random** order.
  - ALL DISC RANDOM : Plays **all** loaded **discs** in **random** order.
  - 1-DISC : Plays **one** selected **disc**.
- (The original display is restored in about 2 seconds.)



## All group play

### DVD-A

Press [PLAY MODE] to select "ALL-GROUP".

The unit plays tracks in all the groups on a disc.

Press [▶] DVD/CD] to play.

## Random play

### While stopped

**VCD** **CD** (There is no on-screen display.)

1 DISC RANDOM: You can play a disc in the play position in random order.

ALL DISC RANDOM: You can play all discs in random order.

**WMA** **MP3**

1 DISC RANDOM: You can play a disc in the play position in random order.

You can play items on a disc in the play position in random order.

Press [▶] DVD/CD] to play.

### Note

During random play, empty trays are skipped and the playback control function on Video CDs is canceled.

## Program play

You can select up to 24 items to play in the order you choose.

### While stopped

**DVD-A** **DVD-V** **VCD** **CD** **WMA** **MP3**

Example **DVD-V**

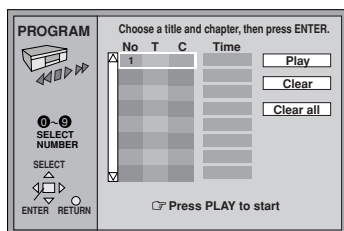

1 Press [DISC] and (within 10 seconds) [1]–[5] to select the disc. Press [■].

2 Press [PROGRAM].

"PGM" appears.

3 Press the numbered buttons to select a title, chapter, group or track (**WMA** **MP3**) then press [ENTER].

Example **CD**

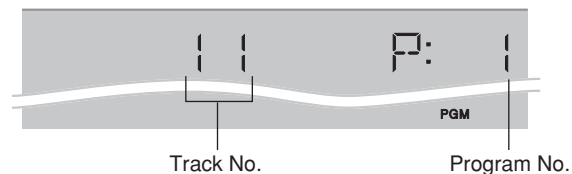

### To select a 2-digit number

Example: To select item 25, press [≥10] → [2] → [5].

**WMA** **MP3** [2] → [5] → [ENTER]

• Repeat this step to program other items.

### • **DVD-A** **DVD-V** **WMA** **MP3**

#### To select an item using the cursor buttons

Press [ENTER] and [▲, ▼] to select an item, then press [ENTER] again to register the number.

All the items in the selected disc, title or group are selected when you select "ALL".

4 Press [▶] DVD/CD] to play.

### To add or change the program

Press [▲, ▼] to select an available item, then repeat step 3.

### To clear an item

1. Select the item you want to clear with [▲, ▼].

2. Press [SHIFT]+[CANCEL], or select "Clear" with [▲, ▼, ◀, ▶] and press [ENTER].

### To clear the whole program

Select "Clear all" with [▲, ▼, ◀, ▶] and press [ENTER].

### Note

• **DVD-V** **WMA** **MP3**

Times are not displayed while programming.

• The program is cleared when you switch the unit to standby, select another source or move the disc out of the play position.

### Note

Disable HighMAT disc play to use random and program play.

In the SETUP menu, set "HighMAT" to "Disable" (⇒ page 36) and perform the necessary operations (⇒ above).

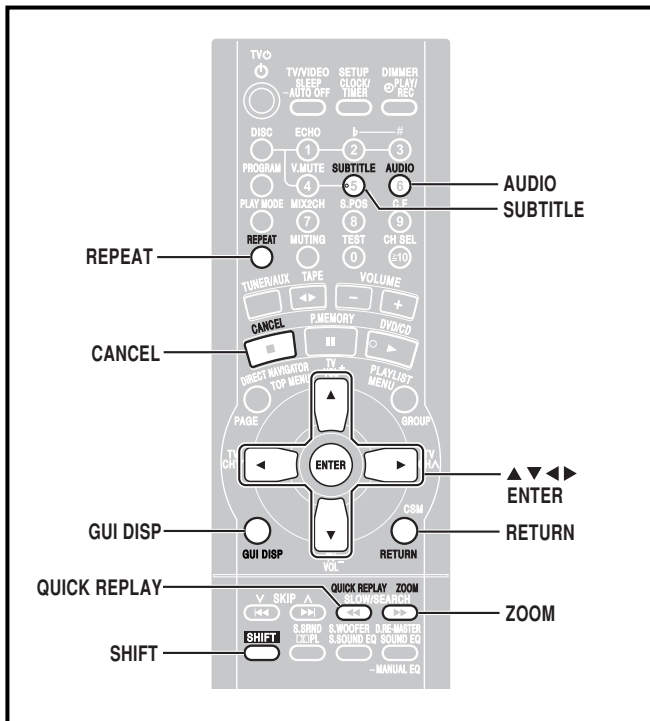

**Remote control only**

• “-” or “..” is displayed instead of the language number in circumstances such as when no language is recorded on the disc.

**VCD (SVCD only)**

Soundtrack and subtitle numbers may change even if corresponding soundtracks are not recorded.

**Soundtracks**

**RAM DVD-A DVD-V VCD**

(Discs with multiple soundtracks)

**During play**

Press **[SHIFT]+[AUDIO]**.

The number changes each time you press the button.

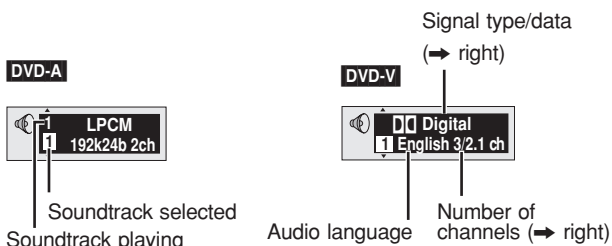

**RAM VCD**

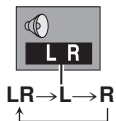

• You can also use this button to turn the vocals on and off on karaoke discs. Read the disc’s instructions for details.

**DVD-A**

- Play restarts from the beginning of the soundtrack when changing soundtracks that are accompanied by still pictures.
- Even if a second soundtrack isn’t recorded, two soundtrack numbers will normally be shown when you press **[SHIFT]+[AUDIO]**. The soundtrack currently playing is number 1.

**Signal type/data**

LPCM/PPCM/DDDigital/DTS/MPEG: Signal type  
 k (kHz): Sampling frequency  
 b (bit): Number of bits  
 ch (channel): Number of channels

Example:

3/2 .1ch

.1	Low frequency effect (not displayed if there is no signal)
0	No surround
1	Mono surround
2	Stereo surround (left/right)
1	Center
2	Front left+Front right
3	Front left+Front right+Center

**Subtitles**

**DVD-A** (Motion picture parts only)

**DVD-V VCD** (SVCD only)

You can change the subtitle language and turn the subtitles on and off.

**RAM**

You can turn the subtitles on and off.

**During play**

Press **[SHIFT]+[SUBTITLE]**.

The number changes each time you press the button.

Example **DVD-V**

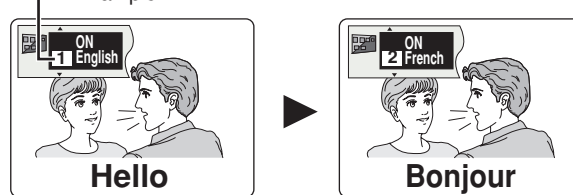

• In some cases, the subtitle language is not changed to the selected one immediately.

**To clear/display the subtitles**

1. Press **[SHIFT]+[SUBTITLE]**.
2. Press **[▶]**. (**DVD-A DVD-V VCD**)
3. Press **[▲, ▼]** to select “OFF” or “ON”.

**Changing the position and brightness of the subtitles (→ page 25)**

**Repeat play**

**RAM DVD-A DVD-V JPEG**

**VCD CD WMA MP3** (There is no on-screen display.)

**During play**

Press **[REPEAT]**.

Each time you press the button:

**RAM**

- PG REPEAT→ALL REPEAT (Entire disc)→REPEAT OFF
- During play list play  
SCENE REPEAT→PL REPEAT→REPEAT OFF

**DVD-V**

CHAPTER REPEAT→TITLE REPEAT\*→REPEAT OFF

**VCD CD**

TRACK REPEAT→ALL REPEAT (Entire disc)→REPEAT OFF

**DVD-A WMA MP3**

TRACK REPEAT→GROUP REPEAT\*→REPEAT OFF

**JPEG**

GROUP REPEAT→REPEAT OFF

\* **During all group (DVD-A), program and random play** “ALL REPEAT” is displayed.

• You can also repeat play of content and group on HighMAT discs.

**To repeat only your favorite tracks/chapters**

Start program play (→ page 17) and press **[REPEAT]** to select the repeat mode.

## A-B repeat play

RAM DVD-A DVD-V VCD CD WMA MP3

You can repeat a section between points A and B within a program, title or track.

### 1 During play

Press [GUI DISP] until the unit information screen is displayed (⇒ page 24).

### 2 Press [▲, ▼] to select the play menu.

Example DVD-A



A-B Repeat

### 3 Press [◀, ▶] to select "A-B Repeat" and

① Press [ENTER] at the starting point (A).

② Press [ENTER] at the finishing point (B).



A-B repeat starts.

### To return to the normal play

Press [ENTER] again.

### To clear the menus

Press [RETURN] or [GUI DISP] until the menu disappears.

#### Note

A-B repeat is canceled when you press [SHIFT]+[QUICK REPLAY].

## Marking places to play again

RAM DVD-A DVD-V VCD CD WMA MP3 JPEG

You can mark a position so you can return to it easily at a later time.

### 1 During play

Press [GUI DISP] until the unit information screen is displayed (⇒ page 24).

### 2 Press [▲, ▼] to select the play menu.

Example DVD-V



Marker

### 3 Press [◀, ▶] to select "Marker" and press [ENTER].

RAM

Press [▶] to select an asterisk (\*).

### 4 Press [ENTER] at the point you want to mark.

### To mark another position

Up to 5 points (RAM only: up to 999 points)

1 Press [▶] to select "\*".

2 Press [ENTER] at the point.

### To recall or erase a marker

1 Press [◀, ▶] to select a marker.

2 Press [ENTER] to recall or press [SHIFT]+[CANCEL] to erase.

## RAM

### To mark the eleventh point and beyond

1 Press [◀, ▶] to select the marker pin icon.

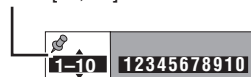

2 Press [▲, ▼] to select "11-20".

You can select the next group when the current group is full.

#### Note

Markers added with this unit clear when you switch the unit to standby, change the source, or change the disc.

## Variable Zoom function

RAM DVD-V VCD

DVD-A (Motion picture parts only)

Change the zoom ratio so the picture expands to the optimum size to fill the screen.

### Preparation

Change the setting "TV Aspect" to suit your television (⇒ page 36).

### During play or while paused

Press [SHIFT]+[ZOOM] to select the aspect ratio.

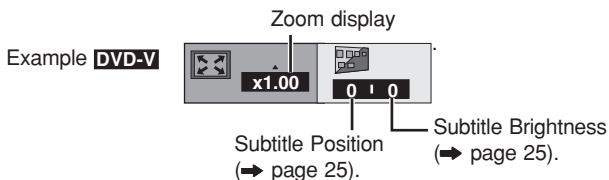

Example DVD-V

Subtitle Position (⇒ page 25).

Subtitle Brightness (⇒ page 25).

Each time you press the button:

4:3 Standard → European Vista → 16:9 Standard

Cinemascope2 ← Cinemascope1 ← American Vista

• Refer to the disc's instructions and "Screen size" below for the aspect ratio of the picture.

### To restore the original ratio

Press [SHIFT]+[ZOOM] until the ratio returns to 1.00.

• The ratio also returns to 1.00 when you change the disc, change the source or switch the unit to standby.

• The ratio may return to 1.00 when a menu is displayed.

### Making fine adjustments to the zoom ratio

While the ZOOM icon is displayed

Press [▲, ▼].

The ratio changes in 0.01 units between 1.00 and 1.60 and in 0.02 units between 1.60 and 2.00.

### Screen size

Movies are made using a variety of screen sizes.

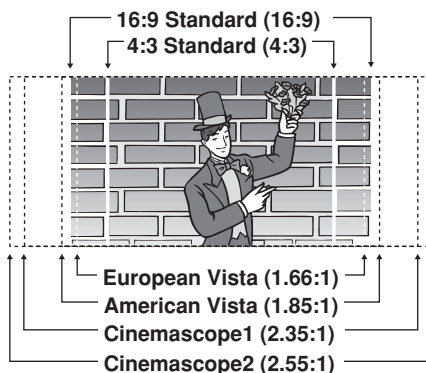

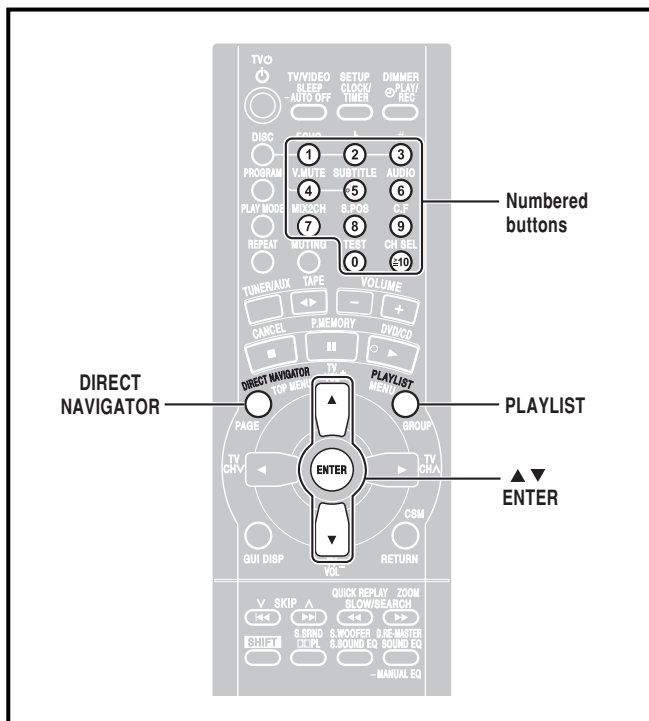

## Using the play list menu

You can play a group of scenes, a play list, created on other equipment such as a DVD video recorder.

### 1 Press [PLAYLIST].

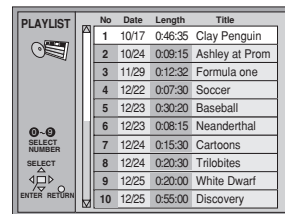

### 2 Press [▲, ▼] to select the play list.

- You can select play lists with the numbered buttons.

**To select a 2-digit number**  
Example 23: [≧10] → [2] → [3]

### 3 Press [ENTER] to start play.

**To clear the play list screen**

Press [PLAYLIST].

## Remote control only

### RAM

## Selecting a program to play — DIRECT NAVIGATOR

Use the program list to find programs to play.

### 1 Press [DIRECT NAVIGATOR].

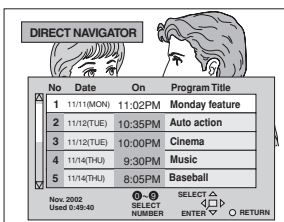

### 2 Press [▲, ▼] to select the program.

The selected program plays in the background.

- You can select programs with the numbered buttons.

**To select a 2-digit number**  
Example 23: [≧10] → [2] → [3]

### 3 Press [ENTER].

The program being played in the background continues.

**To clear the program list**

Press [DIRECT NAVIGATOR].

### Note

- Titles appear only if you have entered them.
- You cannot change program and disc titles.

# WMA/MP3, CD text and JPEG navigation menus

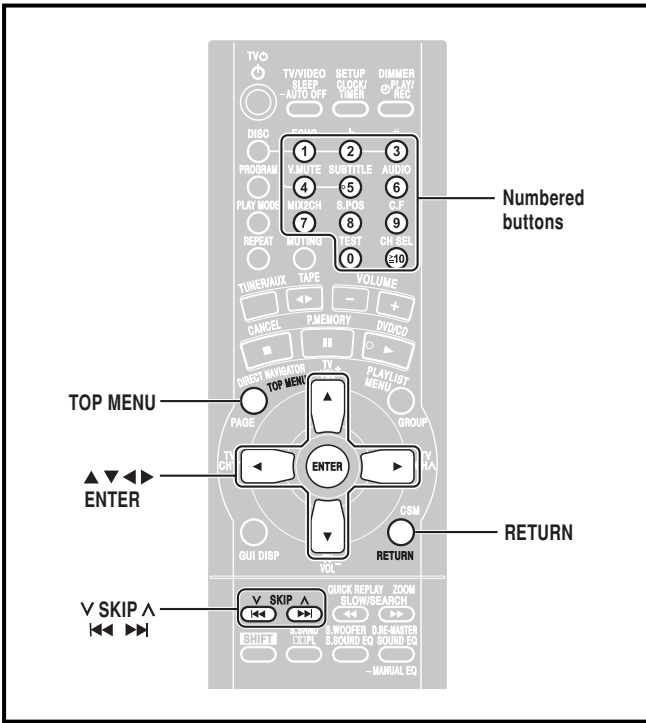

## Track title search **WMA** **MP3** **CD** (CD text only)

Example: finding a track including the word "LOVE"

- While the menu is displayed  
Press [**▲**, **▼**] to select "Find" and press [**ENTER**].

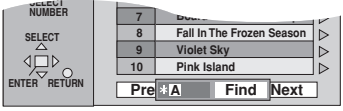

- Press [**▲**, **▼**] to select "L" and press [**ENTER**].  
Characters change in alphanumeric order each time you press [**▲**].  
Repeat this step to enter "O", "V", and "E".
  - Press [**◀**, **▶**] or [**◀**, **▶**] to skip between A, E, I, O, and U.
  - Only uppercase appear but the search also includes lower case.
  - Press [**◀**] to erase a character.
  - You can erase the asterisk (\*) to search for the first word in a title.
  - You can enter numbers with the numbered buttons.

- Press [**▶**] to select "Find" and press [**ENTER**].  
The search results screen appears.

- Press [**▲**, **▼**] to select the track and press [**ENTER**].

To return to the menu  
Press [**RETURN**].

## To use the tree screen to find a group **WMA** **MP3** **JPEG**

- While the menu is displayed  
**WMA** **MP3**  
Press [**▶**] while a track is highlighted to display a tree screen.  
**JPEG**  
Press [**▲**, **▼**, **◀**, **▶**] to select "Tree" and press [**ENTER**].  
Example **MP3**

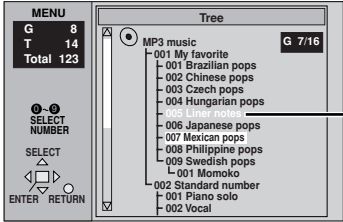

You cannot select groups that contain non compatible files.

- Press [**▲**, **▼**, **◀**, **▶**] to select a group and press [**ENTER**].  
The audio navigation menu/album display for the group appears.

To return to the menu  
Press [**RETURN**].

### Remote control only

If the disc contains both audio data (WMA and MP3) and JPEG, check "Mixed Disc—Audio & Stills" setting in the SETUP menu (→ page 36). Select "Stills (JPEG)" or "Audio (MP3/WMA)".

### **WMA** **MP3** **CD** (CD text only) **JPEG**

Various menus help you find items you want to start play.

- Press [**TOP MENU**].

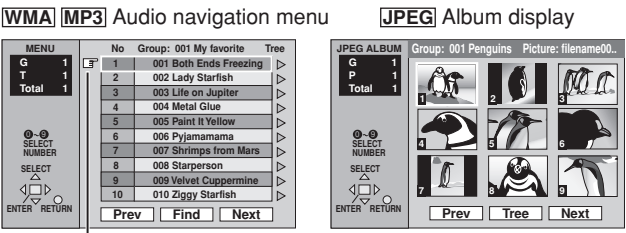

"**▶**" indicates the track currently playing

- Press [**▲**, **▼**] to select a track or [**▲**, **▼**, **◀**, **▶**] to select a picture, and press [**ENTER**].  
To show other pages, press [**▲**, **▼**, **◀**, **▶**] to select "Prev" or "Next" and press [**ENTER**].
  - After listing all the tracks or pictures in one group, select "Next" and press [**ENTER**]. The list for the next group appears.

To exit to the menu  
Press [**TOP MENU**].

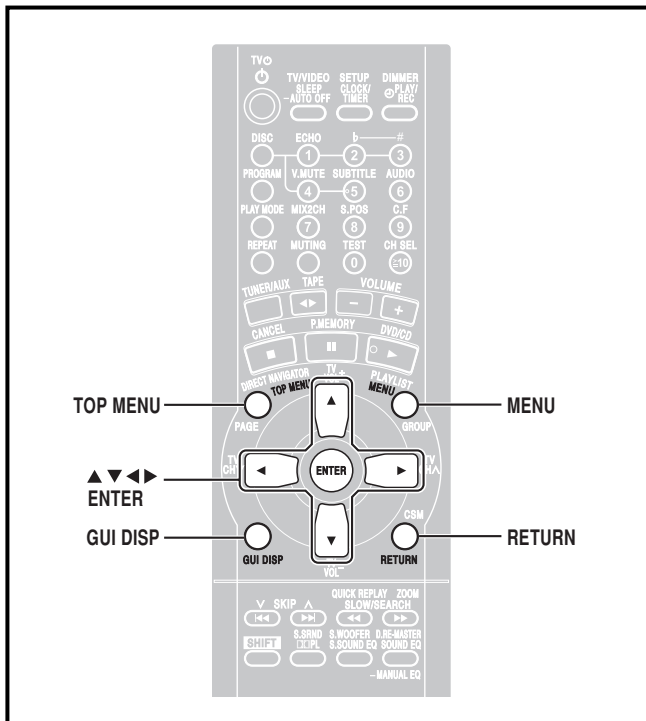

**Remote control only**

To use the contents screen to find a track

(CD text only)

You can use the text information recorded on these discs to find a track to play.

**1 While the menu is displayed**

Press **[▶]** while a track is highlighted to display the contents screen.

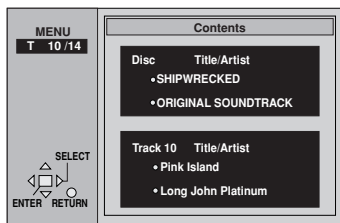

**2 Press [◀, ▶] to move through the tracks and press [ENTER].**

**To return to the menu**

Press [RETURN].

See page 4 for details about WMA, MP3, CD text and JPEG.

**Playing HighMAT discs**

Play HighMAT discs as HighMAT discs (→ page 36, Others-HighMAT).

A menu appears when you select the disc.

Press **[▲, ▼, ◀, ▶]** to select then press **[ENTER]**.

When you press [ENTER]:



Menu: Takes you to the next menu which shows play lists or another menu



Play list: play starts

- To return to the menu screen  
Press [TOP MENU].
- To return to the menu above the current one  
Press [RETURN].
- To change the menu background  
Press [GUI DISP].  
The background changes to the one recorded on the disc.

**Selecting from the lists**

**1 During play**

Press **[MENU]**.

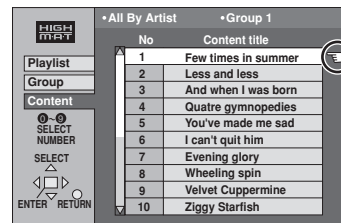

**2 Press [◀] then [▲, ▼] to switch between the play list, group and content lists.**

**3 Press [▶] then [▲, ▼] to select an item and press [ENTER].**

**To exit the list screen**

Press [RETURN].



HighMAT and the HighMAT logo are either trademarks or registered trademarks of Microsoft Corporation in the United States and/or other countries.



Unless otherwise indicated, select items with [◀, ▶] and change with [▲, ▼].

### Disc information

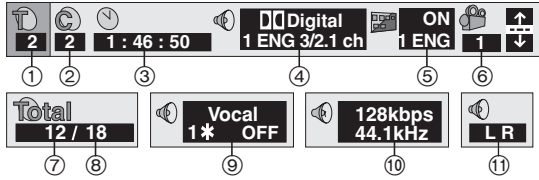

Disc operations

①	PG: Program number <b>RAM</b> PL: Play list number <b>RAM</b> G: Group number <b>DVD-A WMA MP3 JPEG</b> T: Title number <b>DVD-V</b> Track number <b>VCD CD</b>	[▲, ▼] ↓ [ENTER]
②	T: Track number in group <b>DVD-A WMA MP3</b> C: Chapter number <b>DVD-V</b> P: Picture number <b>JPEG</b>	
③	<b>Time RAM DVD-A DVD-V</b> Select a position to start play by specifying a time.  <b>Changing the time display</b> <b>RAM DVD-A DVD-V VCD CD</b> <b>VCD</b> (SVCD only) <b>WMA MP3</b> Display only →Elapsed play time for the program, play list, title or track ↓ ↑ Remaining time for the group ( <b>DVD-A</b> ) or disc ( <b>VCD CD</b> ) ↓ ↑ →Remaining time for the program, play list, title or track	Numbered buttons ↓ [ENTER]
④	<b>Soundtrack RAM DVD-A DVD-V</b> (→ page 18) Refer to "Audio/Subtitle language" (→ right) for language abbreviations.	
⑤	<b>Subtitle language DVD-A DVD-V VCD</b> (SVCD only) (→ page 18) Refer to "Audio/Subtitle language" (→ right) for language abbreviations. <b>Subtitles on/off RAM DVD-A DVD-V VCD</b> (SVCD only) <b>Track information on/off WMA MP3 CD</b> (CD text only) <b>Picture data JPEG</b> Full: Group title, picture title, picture size, file size, date of shooting, and camera model used.* Date: Date of shooting only. OFF: No display * Displays differ depending on the type of camera and condition of the data.	

⑥	<b>Angle number DVD-A DVD-V</b> <b>Picture rotation JPEG</b> 0 ↔ 90 ↔ 180 ↔ 270 ↑	
⑦	<b>Track/picture number in disc</b> <b>WMA MP3 JPEG</b>	[▲, ▼] ↓ [ENTER]
⑧	<b>Total number of tracks/pictures on disc</b> <b>WMA MP3 JPEG</b>	Display only
⑨	<b>Karaoke vocal on/off DVD-V</b> (Karaoke DVD only) If a DVD title is a duet, select V1 or V2 to duet with the unit.	
⑩	<b>Current bitrate (kbps)</b> <b>Current sampling frequency (kHz)</b> <b>WMA MP3</b>	Display only
⑪	<b>Audio mode RAM VCD</b> LR ↔ L ↔ R ↑	
⑫	<b>Menu play</b> <b>VCD</b> (with playback control only)	Display only
⑬	<b>Still picture number DVD-A</b> • To return to page 1 [◀, ▶] → Select "Return" → [ENTER]	
⑭	<b>Slide show DVD-A</b> Picture number	Display only
⑮	<b>Slide show setting JPEG</b> ON ↔ OFF	
⑯	<b>Slide show timing JPEG</b> 0 sec–30 sec	

#### Audio/Subtitle language

ENG: English	SVE: Swedish	CHI: Chinese
FRA: French	NOR: Norwegian	KOR: Korean
DEU: German	DAN: Danish	MAL: Malay
ITA: Italian	POR: Portuguese	VIE: Vietnamese
ESP: Spanish	RUS: Russian	THA: Thai
NLD: Dutch	JPN: Japanese	*: Others

### Unit information

#### Play menu

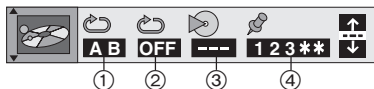

①	<b>A-B repeat</b> (→ page 19) <b>RAM DVD-A DVD-V VCD CD WMA MP3</b>	[ENTER]
②	<b>Repeat mode</b> (→ page 18) <b>RAM DVD-A DVD-V JPEG</b>	
③	<b>Play mode</b> (→ page 16) <b>DVD-A</b> ---: Normal play PGM: Program play ALL: All group play	Display only
④	<b>Marker</b> <b>RAM DVD-A DVD-V VCD CD WMA MP3</b> <b>JPEG</b>	→ Page 19

#### Audio menu

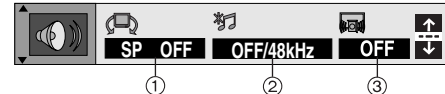

①	<b>Advanced surround (VSS) VK70D</b> (→ page 29) <b>RAM DVD-V VCD</b> • VSS mode SP ↔ HP • SP/HP level 1 ↔ 2 ↔ OFF	
②	<b>Double re-master</b> (→ page 30) <b>RAM DVD-A DVD-V VCD CD WMA MP3</b>	
③	<b>Dialogue Enhancer on/off DVD-V</b> (Discs where the dialogue is recorded in the center channel) This makes the dialogue in movies easier to hear.	



**Display menu**

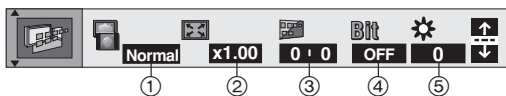

①	<p><b>4:3 Aspect</b>  <b>RAM DVD-A DVD-V VCD JPEG</b>                  Select how to show images made for 4:3 aspect screens on a 16:9 aspect television.</p> <ul style="list-style-type: none"> <li>• <b>Normal:</b> laterally stretches images made for a 4:3 screen.</li> <li>• <b>Auto:</b> expands suitable 4:3 letterbox images to fill more of the screen. Other images appear in full in the center of the screen.</li> <li>• <b>Shrink:</b> images appear in the center of the screen.</li> <li>• <b>Zoom:</b> expands all images to fill the screen.</li> </ul> <p>If your television has a similar feature, use it instead for a better effect.</p>
②	<p><b>Variable zoom function</b> (→ page 19)  <b>RAM DVD-V VCD</b>  <b>DVD-A</b> (Motion picture parts only)</p> <div style="border: 1px solid black; padding: 5px; width: fit-content; margin-left: auto; margin-right: auto;">                 [ENTER]                  ↓                  [◀, ▶]                  ↓                  [ENTER]             </div> <p><b>Making fine adjustments to the zoom ratio</b></p>
③	<p><b>Subtitle position/Subtitle brightness</b> <b>DVD-A DVD-V</b></p> <ul style="list-style-type: none"> <li>• Position (0 to -60): in 2 unit steps</li> <li>• Brightness (Auto*/0 to -9)</li> </ul> <p>* The brightness adjusts automatically against the background.</p>
④	<p><b>Bitrate display on/off</b> <b>RAM DVD-A DVD-V VCD</b></p> <p>During play: shows the bitrate (approximate values) of the video being played                  While paused: shows the data volume of the frame and type of picture (→ page 4, Glossary— I/P/B)</p> <div style="border: 1px solid black; padding: 5px; margin-bottom: 10px;">                 9.438 Mbps ▶             </div> <div style="text-align: center; margin-bottom: 10px;">                 [◀, ▶]             </div> <div style="border: 1px solid black; padding: 5px; display: flex; justify-content: space-between;"> <div style="font-size: small;">                 • Bitrate                  Cur. 7.507 Mbps                  Ave. 6.730 Mbps             </div> <div style="font-size: small;">                 5.0 Mbps             </div> </div> <div style="display: flex; justify-content: space-around; font-size: x-small;"> <div>Current bitrate</div> <div>A record of bitrates for a sampling period.</div> </div> <p style="text-align: center; font-size: x-small;">Average bitrate</p>
⑤	<p><b>OSD brightness</b> (-3 to +3)                  Adjust the brightness of the on-screen displays.</p>

**Picture menu**

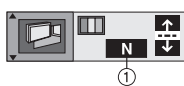

①	<p><b>Picture mode</b> <b>RAM DVD-A DVD-V VCD JPEG</b></p> <ul style="list-style-type: none"> <li>• <b>N:</b> Normal mode</li> <li>• <b>S:</b> Soft mode (Soft picture with fewer video artifacts)</li> <li>• <b>F:</b> Fine mode (Details are sharper)</li> <li>• <b>C1:</b> Mellows images and enhances detail in dark scenes</li> <li>• <b>C2:</b> Sharpens images and enhances detail in dark scenes</li> <li>• <b>U:</b> User mode (→ below)</li> </ul>
---	--

**U**

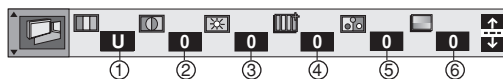

②	<p><b>Contrast</b> (-7 to +7)                  Increases the contrast between light and dark parts of the picture.</p>
③	<p><b>Brightness</b> (0 to +15)                  Brightens the picture.</p>
④	<p><b>Sharpness</b> (-7 to +7)                  Adjusts the sharpness of the edges of the horizontal lines.</p>
⑤	<p><b>Color</b> (-7 to +7)                  Adjust the shade of the picture's color.</p>
⑥	<p><b>Gamma</b> (0 to +5)                  Emphasis of outlines.</p>

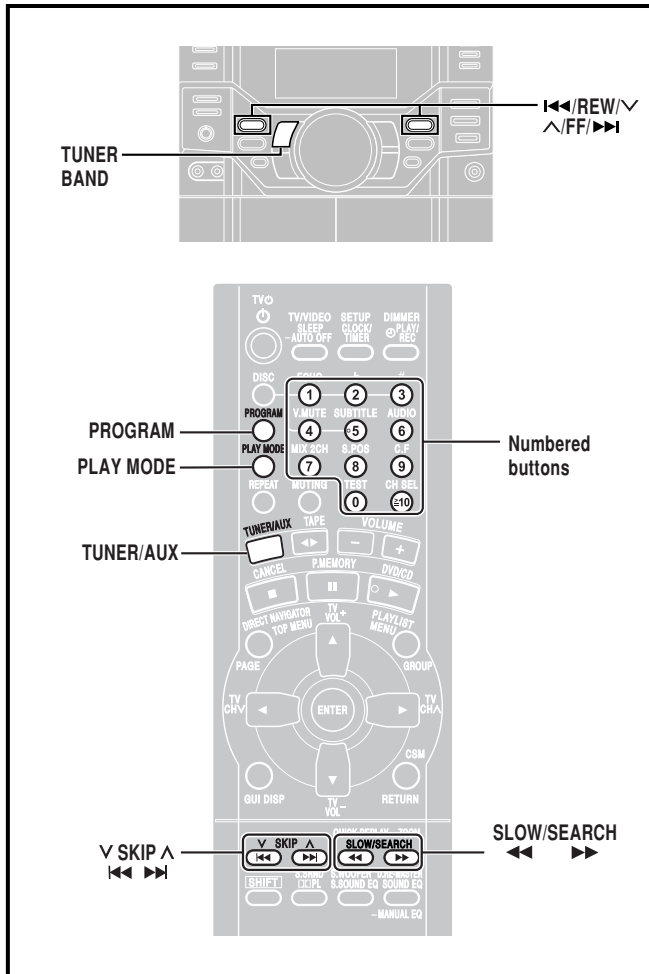

## Manual tuning

- 1 Press [TUNER BAND] (remote control: [TUNER/AUX]) to select "FM" or "AM".**  
The unit comes on.  
Every time you press the button:  
**FM → AM → AUX**
- 2 Press [PLAY MODE] on the remote control to select "MANUAL".**  
Every time you press the button:  
MANUAL ↔ PRESET
- 3 Hold down [◀◀/REW/∨] or [∧/FF/▶▶] (remote control: [◀◀] or [▶▶]) for a moment to search for a station.**  
The frequency stops when it finds a clear station.  
To stop during the process, press [◀◀/REW/∨] or [∧/FF/▶▶] (remote control: [◀◀] or [▶▶]).  
Under excessive interference, a station may not be found.  
Press [◀◀/REW/∨] or [∧/FF/▶▶] (remote control: [◀◀] or [▶▶]) repeatedly to tune step-by-step.

"TUNED" is displayed when a radio station is tuned.  
"ST" is displayed when a stereo FM broadcast is being received.

### If noise is excessive in FM

#### Remote control only

**Hold down [PLAY MODE] to display "MONO".**

Monaural sound is selected and noise reduces when reception is weak.

Hold down [PLAY MODE] again to cancel the mode.

"MONO" is also canceled if the frequency is changed.

## AM allocation setting

### For the Middle East, South Africa and Southeast Asia

#### Main unit only

By adjusting the allocation, you can enable this tuner to receive AM broadcasts allocated in 10 kHz steps.

Press [TUNER BAND] to select "FM".

Press and hold [TUNER BAND]. After a few seconds, the display will change to a flashing display of the current minimum frequency. If you continue to hold the button down, the minimum AM frequency will change. Release the button at this time.

To return to the original frequency indication, repeat above.

#### Note

After changing the "allocation" setting, the frequencies you previously preset in the memory will be cleared.

## Preset tuning

There are two methods of pre-setting stations.

**Automatic presetting** : All the stations the tuner can receive are preset.

**Manual presetting** : You can select the stations to preset and the order they are preset in.

Up to 15 stations each can be set in the FM and AM bands.

#### Preparation:

Press [TUNER BAND] (remote control: [TUNER/AUX]) to select "FM" or "AM".

### Automatic presetting

#### Remote control only

Do the following once each for FM and AM.

**Preparation:** Tune to the frequency where pre-setting is to begin.

#### Hold down [PROGRAM] until the frequency changes.

The tuner presets all the stations it can receive into the channels in ascending order. When finished, the last station memorized is tuned in.



### Manual presetting

Pre-set the stations one at a time.

- 1 Tune to the station (↔ left).**
- 2 Press [PROGRAM].**
- 3 While "PGM" is flashing**  
**Press the numbered buttons to select a channel.**  
Alternatively, press [◀◀/REW/∨] or [∧/FF/▶▶] (remote control: [◀◀, ∨] or [▶▶, ∧]) then press [PROGRAM].

The station occupying a channel is erased if another station is preset in that channel.

## Selecting channels

**Press the numbered buttons to select the channel.**

To enter channel 10 or over, press [≥10], then the two digits.



OR

- 1 Press [PLAY MODE] on the remote control to select "PRESET".**
- 2 Press [◀◀/REW/∨] or [∧/FF/▶▶] (remote control: [◀◀, ∨] or [▶▶, ∧]) to select the channel.**

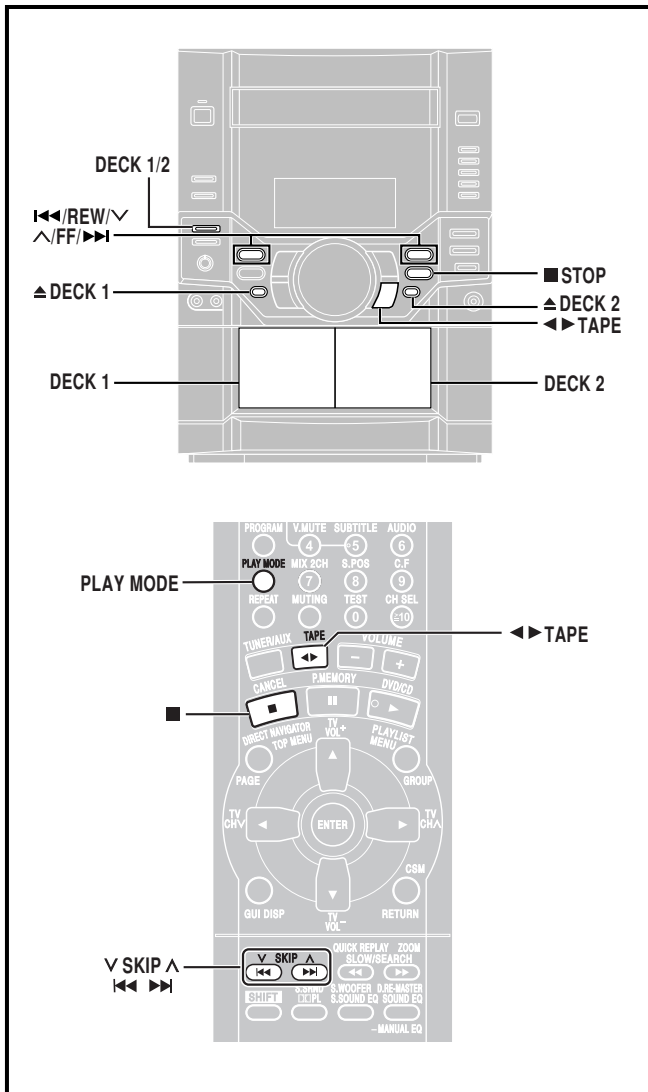

### To stop tape playback

Press [■ STOP] (remote control: [■]).

### To select the reverse mode

While TAPE is selected as the source

Press and hold [PLAY MODE] on the remote control.

Every time you press and hold the button:

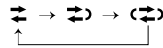

↔ : One side is played.

↔↔ : Both sides are played. (forward → reverse)  
Play stops at the end of the reverse side.

↔↔↔ : Both sides are played repeatedly until [■ STOP] (remote control: [■]) is pressed.

To listen to 2 tapes consecutively, load a tape into each deck and select “↔↔”. Both tapes will be played repeatedly until [■ STOP] (remote control: [■]) is pressed.

### To fast-forward or rewind

Press [⏮/REW/↵] (rewind) or [⏭/FF/▶▶] (fast-forward) (remote control: [⏮, ↵] (rewind) or [⏭, ▶] (fast-forward)).

### To select between loaded decks

Press [DECK 1/2] (remote control: [PLAY MODE]).

### Note

- Tape playback is momentarily interrupted if you open the other deck.
- Tapes exceeding 100 minutes are thin and can break or get caught in the mechanism.
- Tape slack can get caught up in the mechanism and should be taken up before the tape is played.
- Endless tapes can get caught up in the deck's moving parts if used incorrectly. Use tapes appropriate to this unit's auto-reverse mechanism.

You can use either deck 1 or deck 2 for tape playback.

Use normal position tapes.

High position and metal position tapes can be played, but the unit will not be able to do full justice to the characteristics of these tapes.

### 1 Press [◀▶ TAPE].

The unit comes on.

If a cassette was loaded, play starts automatically (One touch play).

### 2 Press [▲ DECK 1] or [▲ DECK 2] on the main unit and insert the cassette.

Insert with the side to be played facing towards you and the exposed tape facing down.

Close the holder by hand.

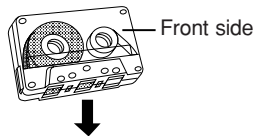

### 3 Press [◀▶ TAPE] to start playback.

Every time you press the button: F ▶ ↔ ◀ R

F ▶ : Forward side is played.

◀ R : Reverse side is played.

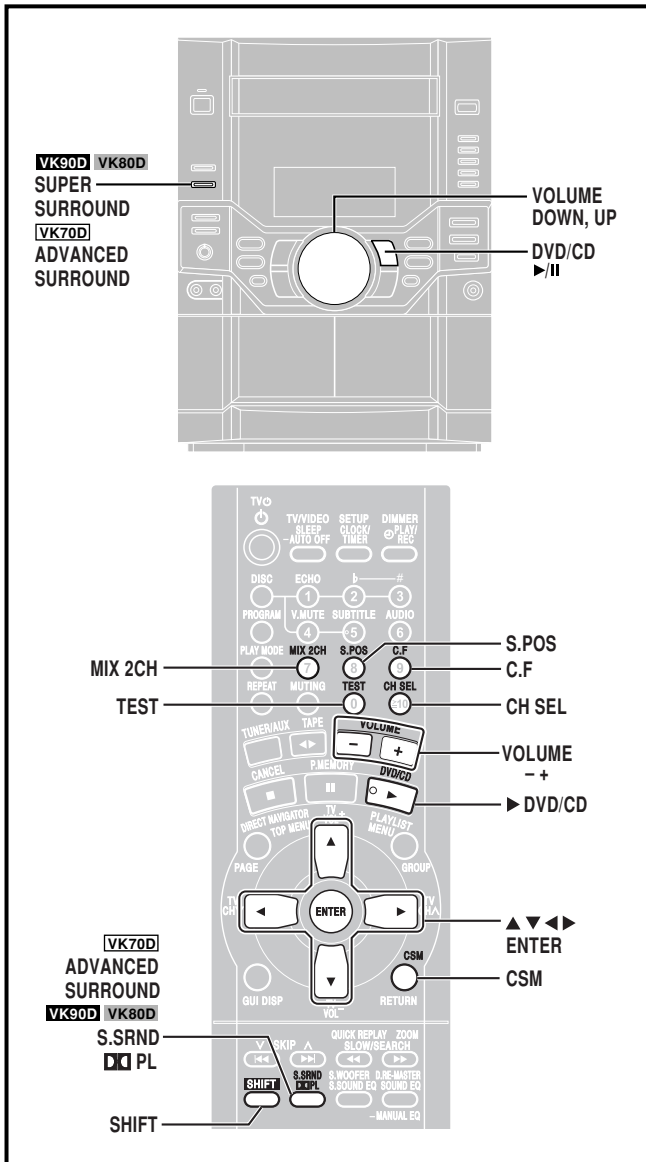

- **VK90D VK80D** Dolby Pro Logic, Super Surround, Center Focus, Seat Position and Subwoofer Level adjusting (→ page 30) cannot be used if headphones are connected (“ERROR” appears on the display).
- You may experience a reduction in sound quality when these sound field systems are used with some sources. If this occurs, turn the sound field system off.

## Dolby Digital and DTS

- Dolby Digital and DTS are digital encoding systems used on DVD to carry surround sound. Both were originally developed for use in cinemas.
- This unit automatically recognizes and decodes these systems.

Software encoded with Dolby Digital can be identified with this mark.



Software encoded with DTS can be identified with this mark.



### Play a Dolby Digital or DTS source.

The Dolby Digital or DTS indicator lights.



### VK90D VK80D

- To down-mix Dolby Digital or DTS (multiple-channel) signals to 2 channels

Press [SHIFT]+[MIX 2CH].



To cancel, press [SHIFT]+[MIX 2CH] again.

### When “NO DOWN MIX” scrolls across the display DVD-A

It indicates that the DVD-Audio contains multiple-channel signals that cannot be down-mixed.

## Dolby Pro Logic

### VK90D VK80D

Dolby Pro Logic is an active process that enhances sound localization through the use of a high separation decoding method providing improved spatiality and a wider listening area. The sense of directionality is enhanced by the Left, Center, Right and Surround channels. Dolby Pro Logic is best utilized with sources encoded in Dolby Surround.

Software encoded with Dolby Surround can be identified with this mark (DVD, CD, Video CD, Laser Disc, Video tape).



- 1 Press [DOLBY PL].
- 2 Play a Dolby Surround source.



### To cancel

Press [DOLBY PL] again.

### Note

This does not work when playing multi-channel Dolby Digital.

## Speaker level adjustments

### VK90D VK80D

Adjust the level of the speakers so they are the same apparent level as the front speakers where you would normally be sitting and listening. (L, R → page 29, “Balance”)

### Preparation

Press [▶/|| DVD/CD]. (remote control: [▶ DVD/CD])

- 1 Press [SHIFT]+[TEST] to output a test signal.  
Lch: Front left  
Cch: Center  
Rch: Front right  
RSch: Right surround  
LSch: Left surround
- 2 Press [VOLUME DOWN, UP] (remote control: [VOLUME +] or [-]) to set the volume level normally used for listening.
- 3 Press [▲] (to increase) or [▼] (to decrease).  
C, RS, LS: -6 dB to +6 dB  
To stop the test signal, press [SHIFT]+[TEST] again.

### ■ To adjust speaker level during play

- 1 Press [SHIFT]+[CH SEL] to select the speaker.

Lch→Cch→Rch→RSch→LSch→SWch  
↑

SWch: Subwoofer

- You can only adjust SWch if the disc includes a subwoofer channel.
- SWch does not appear on the display and is not adjustable when Dolby Pro Logic is turned on.

- 2 Press [▲] (to increase) or [▼] (to decrease).

L, R: (→ page 29, “Balance”)  
C, RS, LS: -6 dB to +6 dB  
SW: -6 dB to +6 dB

### Balance

You can adjust the balance of the front speakers.

1 Press [SHIFT]+[CH SEL] to select "L" or "R".

2 Press [◀, ▶].

- When testing signal, you can also adjust the "L" or "R" balance of the front right and left speakers by pressing [◀, ▶].

### Super Surround

VK90D VK80D

Add surround effects to stereo sound.

S.SRND

Press [SHIFT]+[S.SRND].

Each time you press the button:

MUSIC→MOVIE→STEREO SOUND

**MUSIC:** Adds surround effects to stereo sources.

**MOVIE:** Use this mode when playing movie software.

- You can adjust the volume of the surround speakers to get the best surround effect (⇒ page 28, Speaker level adjustments).

#### Note

- Turn Super Surround off when playing a DVD recorded with Dolby Digital or DTS. The surround effects will not be reproduced correctly if this is left on.
- Dolby Pro Logic (⇒ page 28) switches off.

### Advanced Surround

VK70D

RAM DVD-V VCD

Enjoy a surround-like effect when using 2 front speakers (SP) or headphones (HP). The effect broadens when playing discs with surround effects and sound seems to come from speakers on either side of you.

Press [ADVANCED SURROUND].



Each time you press the button:

- ADV SURR 1: Natural effect
- ↓
- ADV SURR 2: Emphasized effect
- ↓
- SURR OFF: Cancel (factory preset)

- Use the Audio Menu (⇒ page 24) to change the SP/HP mode.

#### Optimum seating position

<When using television's speakers>

Distance A=Television's width

- This does not work or has less effect with some discs.
- Turn off if it causes distortion.
- Do not use in combination with surround effects on other equipment.

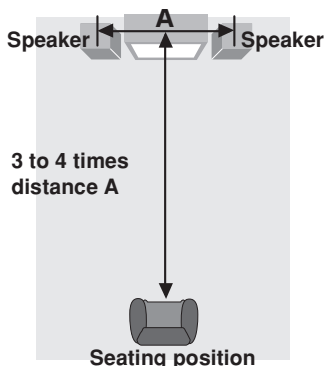

### Center Focus

VK90D VK80D

(Discs where the dialogue is recorded in the center channel)

You can make the sound of the center speaker seem like it is coming from within the television.

Press [SHIFT]+[C.F.].

C.F.

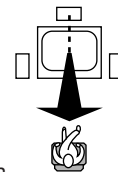

Each time you press the button:

CENTER FOCUS ←→ OFF

- This does not work when Super Surround is turned on.
- This will have less effect when Dolby Pro Logic is turned on.

### Seat Position

VK90D VK80D

Using this function makes you feel like you are sitting in the ideal seating position (in the center of the circle formed by the speakers), even if you cannot due to the layout of your room.

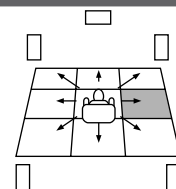

During play

1 Press [SHIFT]+[S.POS].

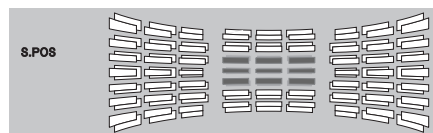

2 Press [▲, ▼, ◀, ▶] to select a position.

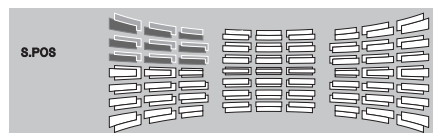

Each time you press the button:

SEAT POSITION ←→ OFF

To cancel

Press [SHIFT]+[S.POS] to clear "S.POS".

### Custom Sound Memory—Store the sound settings

DVD-A DVD-V VCD CD

Store the sound settings for a disc so the unit recalls them the next time you play it.

- Number of discs: 30
- Settings: VK90D VK80D Dolby Pro Logic, Subwoofer level, Center Focus, Super Surround, Sound EQ, Manual EQ, Super Sound EQ, Seat Position.
- VK70D Advanced Surround, Sound EQ, Manual EQ, Super Sound EQ.

#### Store the settings

1 Make the settings.

2 Press and hold [SHIFT]+[CSM].

CSM

#### Recall the settings

The unit recalls the settings when you play the disc again.

- The settings are replaced if you change them.
- When you store settings for a 31st disc, the earliest settings disappear.
- Press [SHIFT]+[CSM] while "CSM" is lit and the settings return to those that were on before the settings are recalled.
- Press [SHIFT]+[CSM] while "CSM" is out and you are playing a disc for which you stored settings and those settings are recalled.

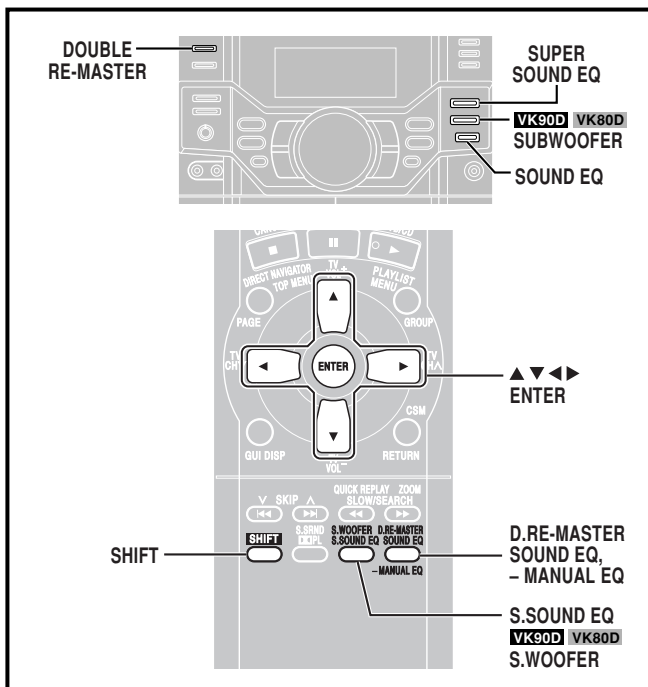

## Double re-master—Enjoying more natural sound

RAM DVD-A DVD-V CD

Discs recorded with 2-channel LPCM at 44.1 kHz or 48 kHz

This feature gives you a more natural sound by adding the higher frequency signals not recorded on the disc.

WMA MP3

Discs recorded at 44.1 kHz or 48 kHz

This feature reproduces the frequencies lost during recording to give you a sound closer to the original.

During play

Press [DOUBLE RE-MASTER] (remote control: [SHIFT]+[D.RE-MASTER]).



Output sampling frequency

Each time you press the button:

Setting	RAM DVD-A DVD-V CD	WMA MP3
	Type of music	Effect level
1	High tempo (e.g., pops and rock)	Light
2	Various tempos (e.g., jazz)	Medium
3	Low tempo (e.g., classical)	Strong
OFF	Off	Off

**Note**

VK70D

The actual output sampling frequency depends on the PCM Digital Output setting (→ page 38) when using a digital connection (→ page 39).

## Changing sound field and quality

Press [SOUND EQ] to select a setting.

Each time you press the button:

- HEAVY: Adds punch to rock.
- SOFT: For background music.
- CLEAR: Clarifies higher sounds.
- DISCO: Reverberates sound to make you feel like you were in a disco.
- LIVE: Makes vocals more alive.
- HALL: Expands sound to make you feel like you were in a hall.
- EQ-OFF: Canceled (no effect is added).

**Note**

SOUND EQ, MANUAL EQ and SUPER SOUND EQ cannot be used at the same time.

## Using the Manual Equalizer (MANUAL EQ)

Create your own sound quality effects.

1 Press and hold [–MANUAL EQ] on the remote control until “MANUAL EQ” appears.

2 (Within 10 seconds)

Change the sound quality with the cursor buttons.

- ① Select the sound range to be adjusted with [◀] or [▶].
- ② Adjust the level with [▲] or [▼].

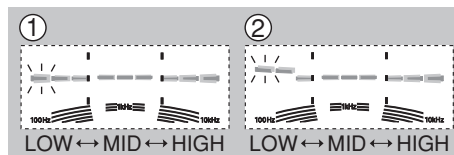

Repeat step 2 to set the desired sound quality.

The original display is restored on the display panel in about 10 seconds.

**To cancel**

Press [–MANUAL EQ] to select “EQ-OFF”.

The changes you make are stored and automatically recalled the next time you select “MANUAL EQ”.

## Using the Super Sound Equalizer

Turning on the super sound equalizer gives you a more powerful sound.

Press [SUPER SOUND EQ] (remote control: [S. SOUND EQ]).

The indicator lights.

**To cancel**

Press [SUPER SOUND EQ] (remote control: [S. SOUND EQ]) so the indicator turns off.

## Adjusting the bass

VK90D VK80D

Press [SUBWOOFER] (remote control: [S.WOOFER]).



Each time you press the button:

SUB W LOW → SUB W MID → SUB W MAX  
 ↑ (Off) ↓

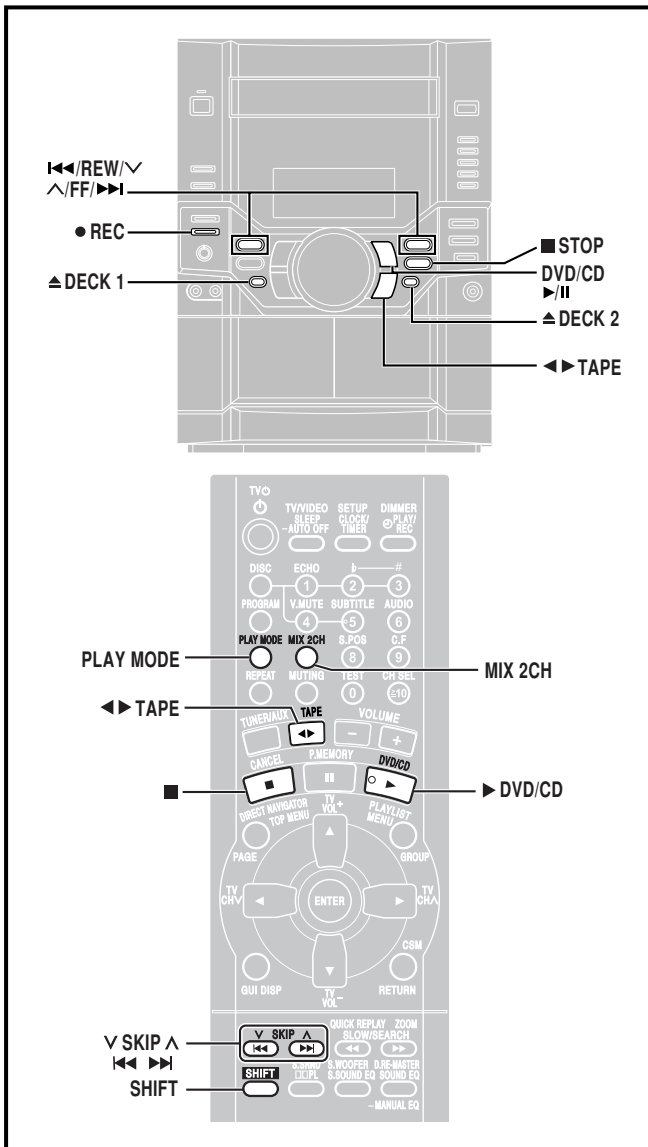

### Selection of tapes for recording

Use normal position tapes.  
High position and metal position tapes can be used, but this unit will not be able to record or erase them correctly.

#### Preparation:

Wind up the leader tape so recording can begin immediately.

### 1 Press [▲ DECK 2] on the main unit and insert the cassette to be recorded.

Insert with the side to be recorded facing towards you and the exposed tape facing down.  
The tape direction is automatically set to "F".

### 2 Press and hold [PLAY MODE] on the remote control to select the reverse mode.

Every time you press and hold the button:

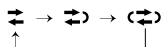

- F : One side only records.
- F, R : Both sides record (forward → reverse).
- "F" is automatically changed to "R" when [● REC] is pressed.

### 3 Select the source to be recorded.

#### Radio recording:

Tune in the station. (→ page 26)

#### Disc recording:

- ① Insert the disc(s) you want to record.  
Press [▶/|| DVD/CD] (remote control: [▶ DVD/CD]) and then [■ STOP] (remote control: [■]).
- ② Prepare the desired disc recording mode.
  - To record programmed tracks (→ do steps 1–3 on page 17 for CD, MP3 or WMA).
  - To record specific disc(s)/tracks (→ do steps 1–2 on page 16 for CD, MP3 or WMA).  
Ensure disc is stopped.  
For 1-SONG mode: Press [◀◀/REW/∨] or [∧/FF/▶▶] (remote control: [◀◀, ∨] or [▶▶, ∧]) to select the track.

#### Tape-to-tape recording:

- ① Press [◀▶ TAPE] and then [■ STOP] (remote control: [■]).
- ② Press [▲ DECK 1] on the main unit and insert the cassette you want to record.

### 4 Press [● REC] on the main unit to start recording.

#### To stop recording

Press [■ STOP] (remote control: [■]).

#### If the tape finishes before the disc

The disc continues playing. Press [■ STOP] (remote control: [■]) to stop it.

### Reducing noise when recording AM

#### Remote control only

#### Hold down [PLAY MODE] while recording.

Every time you hold down the button: BP1 ↔ BP2  
Choose the setting with the least noise.

#### Note

- Changes to volume and sound/field quality do not affect recording except for Double re-master.
- You cannot open deck 1 while recording.
- You cannot fast-forward or rewind one deck while recording with the other.
- Before recording multi-channel sources (3 to 5.1 channels), press [SHIFT]+[MIX 2CH] to down-mix the signals to 2 channels.

#### Erase prevention

Use a screwdriver or similar object to break out the tab.

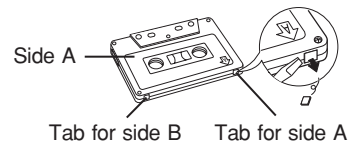

#### To re-record on a protected cassette

Cover the hole with adhesive tape.

#### To erase a tape

1. Press [◀▶ TAPE] and then [■ STOP] (remote control: [■]).
2. Insert the recorded tape into deck 2.  
Ensure there is no tape in deck 1.
3. Press and hold [PLAY MODE] on the remote control to select reverse mode.
4. Press [● REC].

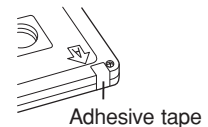

# Enjoying karaoke

(For the Middle East, South Africa and Southeast Asia)

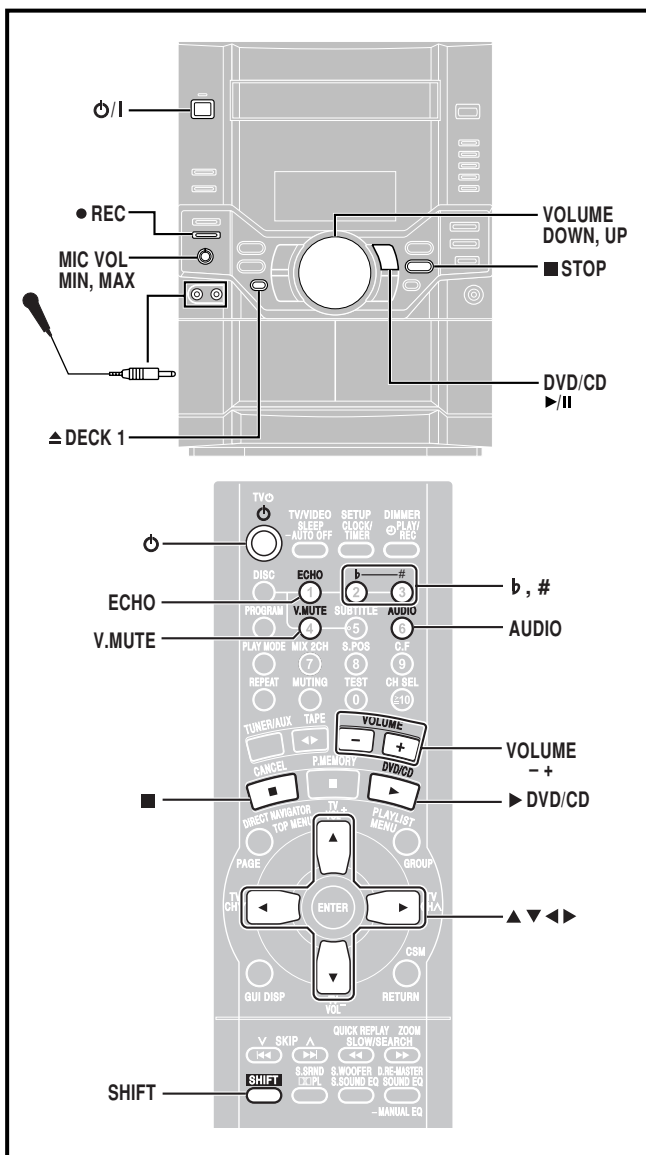

### Preparation:

- Press [⏻/⏪] (remote control: [⏻]) to turn the unit on.
- Turn on the television and switch the video-input mode on the television to suit the connection.
- Lower the microphone volume with [MIC VOL MIN, MAX] on the main unit, then connect the microphone to the microphone jacks. Use a dynamic microphone. Plug type: 3.5 mm monaural

### V. MUTE function:

#### Remote control only

Use this function when enjoying sources not formatted for karaoke. The voice portion of the track is blocked out but not the background music.

#### Preparation:

##### RAM VCD

Press [SHIFT]+[AUDIO] to select "LR".

#### Press [SHIFT]+[V.MUTE] to switch the function on or off.

You need software recorded in stereo sound if you want to use the voice mute function. Voice and/or static may be reproduced with the following types of software.

- Software recorded monaural
- Classical music, or works performed by a limited number of instruments
- Chorus works or duets
- There might be some strange sound heard during playback.

#### Note

- If a strange noise (squealing or howling) is emitted during use, move the microphone away from the speakers, or turn down the microphone volume.
- When you are not using the microphone, disconnect it from the microphone jacks, and turn down the microphone volume level to "MIN".

## Enjoying karaoke with karaoke DVD

### DVD-V

1 Insert the disc and start play (→ page 14).

2 ① Press [SHIFT]+[AUDIO] on the remote control during play.

② Press the cursor buttons [◀], [▶] on the remote control to highlight the illustrated icon.

③ Press the cursor buttons [▲], [▼] on the remote control to turn the vocals on or off.

- |               |                      |
|---------------|----------------------|
| • Solo        | • Duet               |
| OFF: No vocal | OFF: No vocal        |
| ON: Vocal     | V1+V2: Vocal 1 and 2 |
|               | V1: Vocal 1          |
|               | V2: Vocal 2          |

Choose "OFF" for karaoke.

Choose "V1" or "V2" to duet with the player.

Actual operations depend on the disc. Read the disc's instructions for details.

3 Start singing and adjust volume with [VOLUME DOWN, UP] (remote control: [VOLUME +] or [-]) and [MIC VOL MIN, MAX] on the main unit.



## Enjoying karaoke with other karaoke sources

RAM VCD CD WMA MP3 TUNER CASSETTE AUX

### Preparation:

Press [SHIFT]+[V.MUTE] on the remote control to switch V.MUTE function off.

### 1 RAM VCD CD WMA MP3

Insert the disc and start play (→ page 14).

TUNER

Do steps 1-3 on page 26 (manual tuning) to select the desired station.

CASSETTE

Do steps 1-3 on page 27 to start playback.

AUX

Do steps 1-3 on page 39 to operate from an external source connect to the AUX jack.

### 2 Press [SHIFT]+[AUDIO] on the remote control.

Each time you press the button:

CD WMA MP3 TUNER CASSETTE AUX

NORMAL → MONO L → MONO R

RAM VCD



LR → L → R

NORMAL (LR): Left channel sound is heard from the left speaker and right channel sound is heard from the right speaker. (Vocal and accompaniment)

MONO L (L): Only left channel sound (No vocal)

MONO R (R): Only right channel sound (Vocal)

Select no vocal for karaoke.

Vocal and no vocal may be reversed.

### 3 Start singing and adjust volume with [VOLUME DOWN, UP] (remote control: [VOLUME +] or [-]) and [MIC VOL MIN, MAX] on the main unit.

## Changing the key

### Remote control only

To raise the key by a halfitone:

Press [SHIFT] + [#].

Each time the button is pressed, the key will change as follows:

KEYCON -6 → -5 → -4 → -3 → -2 → -1 → 0 → +1 → +2 → +3 → +4 → +5 → +6

To lower the key by a halfitone:

Press [SHIFT] + [b].

Each time the button is pressed, the key will change as follows:

KEYCON +6 → +5 → +4 → +3 → +2 → +1 → 0 → -1 → -2 → -3 → -4 → -5 → -6

### To cancel

Press [SHIFT] + [b]/[#] to display "0".

## Adding an echo effect

### Remote control only

Press [SHIFT]+[ECHO].

Each time you press the button:

ECHO 1 → ECHO 2 → ECHO 3 → ECHO 4 → ECHO OFF (off)

↑

The effect increases with the level.

## To record your karaoke performance

### Preparation:

• Do the preparatory steps 1–2 on page 31.

• When singing along with discs

Insert the disc(s) you want (→ page 14).

Press [▶/|| DVD/CD] (remote control: [▶ DVD/CD]) and then [■ STOP] (remote control: [■]).

• When singing along with tape

Press [▲ DECK 1] on the main unit and insert the tape you want.

• When singing along with radio

Select your desired station (→ page 26).

• When singing along from an external source

Connect and prepare the source (→ page 39).

### 1 Press [SHIFT]+[AUDIO] on the remote control to select the voice mode.

### 2 Adjust volume with [VOLUME DOWN, UP] (remote control: [VOLUME +] or [-]) and [MIC VOL MIN, MAX] on the main unit.

Press [● REC] and start karaoke performance.

### To stop recording

Press [■ STOP] (remote control: [■]).

### Note

To playback the recorded tape, be sure to press [SHIFT]+[AUDIO] on the remote control to select the "NORMAL" mode.

## To record your voice

Preparation: Do the preparatory steps 1–2 on page 31. Ensure that there is no tape in deck 1.

### 1 Press [● REC] to start recording.

### 2 Speak through the microphone and adjust volume with [VOLUME DOWN, UP] (remote control: [VOLUME +] or [-]) and [MIC VOL MIN, MAX] on the main unit.

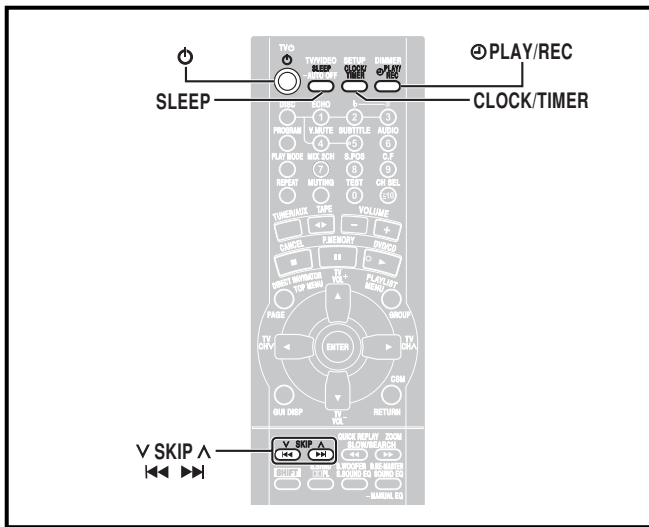

## Remote control only

### The play/record timer

You can set the timer to come on at a certain time to wake you up (play timer) or to record a radio station or from the aux source (record timer).

The play and record timers cannot be used together.

#### Preparation:

- Turn the unit on and set the clock (⇒ page 11).
- **For the play timer**, prepare the desired music source (tape/disc/radio/aux), and set the volume.
- **For the record timer**, check the cassette's erasure prevention tabs (⇒ page 31) and insert the tape in deck 2 (⇒ page 31). Tune to the radio station (⇒ page 26) or select the aux source (⇒ page 39).

#### 1 Press [CLOCK/TIMER] to select the timer function.

Every time you press the button:

CLOCK → ◉PLAY → ◉REC

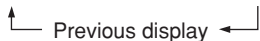

◉PLAY: to set the play timer

◉REC: to set the record timer

#### 2 ON time setting

- ① (Within 7 seconds or so)  
Press [◀◀, V] or [▶▶, ^] to set the start time.
- ② Press [CLOCK/TIMER].

#### 3 OFF time setting

- ① Press [◀◀, V] or [▶▶, ^] to set the finish time.
- ② Press [CLOCK/TIMER].

The start and finish times are now set.

#### 4 Press [◉PLAY/REC] to display the timer indicator.

Every time you press the button:

◉PLAY → ◉REC

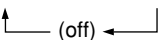

◉PLAY: to turn the play timer on

◉REC: to turn the record timer on

(The indicator doesn't appear if the start and finish times or the clock hasn't been set.)

#### 5 Press [⏻] to turn the unit off.

The unit must be off for the timers to operate.

- **Play timer:** Play will start in the set condition at the set time with volume increasing gradually to the set level.
- **Record timer:** The unit comes on 30 seconds before the set time with the volume muted.

#### To cancel the timer

Press [◉PLAY/REC] to clear the timer indicator from the display. (The timer comes on at the set time everyday if the timer is on.)

#### To change the settings (when the unit is on)

##### To change the play/record times

Do steps 1, 2, 3 and 5.

##### To change the source or volume

1. Press [◉PLAY/REC] to clear the timer indicator from the display.
2. Make changes to the source or volume.
3. Do steps 4 to 5.

##### To change the timer

Press [◉PLAY/REC] to select the desired timer.

Every time the button is pressed:

◉PLAY → ◉REC

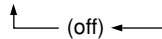

##### To check the settings

Press [CLOCK/TIMER] while the unit is on to select "◉PLAY" or "◉REC".

The settings are shown in the following order:

Play timer: start time→finish time→source→volume

Record timer: start time→finish time→source

To check the settings while the unit is off, press [CLOCK/TIMER] twice.

#### If you use the unit after the timers are set

After using, check that the correct tape/disc are loaded before turning the unit off.

#### Note

- If you turn the unit off and on again while a timer is functioning, the finish time setting will not be activated.
- If you selected AUX as the source, when the timer comes on, the unit turns on and engages "AUX" as the source. If you want to playback or record from a connected unit, set that unit's timer to the same time. (See the connected unit's instruction manual.)
- The record timer cannot be used with HighMAT and JPEG discs.

### The sleep timer

This timer turns the unit off after a set time.

#### While enjoying the desired source:

##### Press [SLEEP] to select the time (minutes).

Every time you press the button:

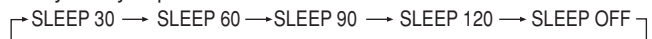

#### To cancel the sleep timer

Press [SLEEP] to select "SLEEP OFF".

#### To confirm the remaining time

Press [SLEEP] once.

The remaining time is shown for about 5 seconds.

#### To change the setting

Press [SLEEP] to select the new setting.

You can use the sleep timer in combination with the play/record timer.

Make sure the unit is off before the play/record timer's start time.

#### Note

The sleep timer will be turned off when you start recording from a disc.

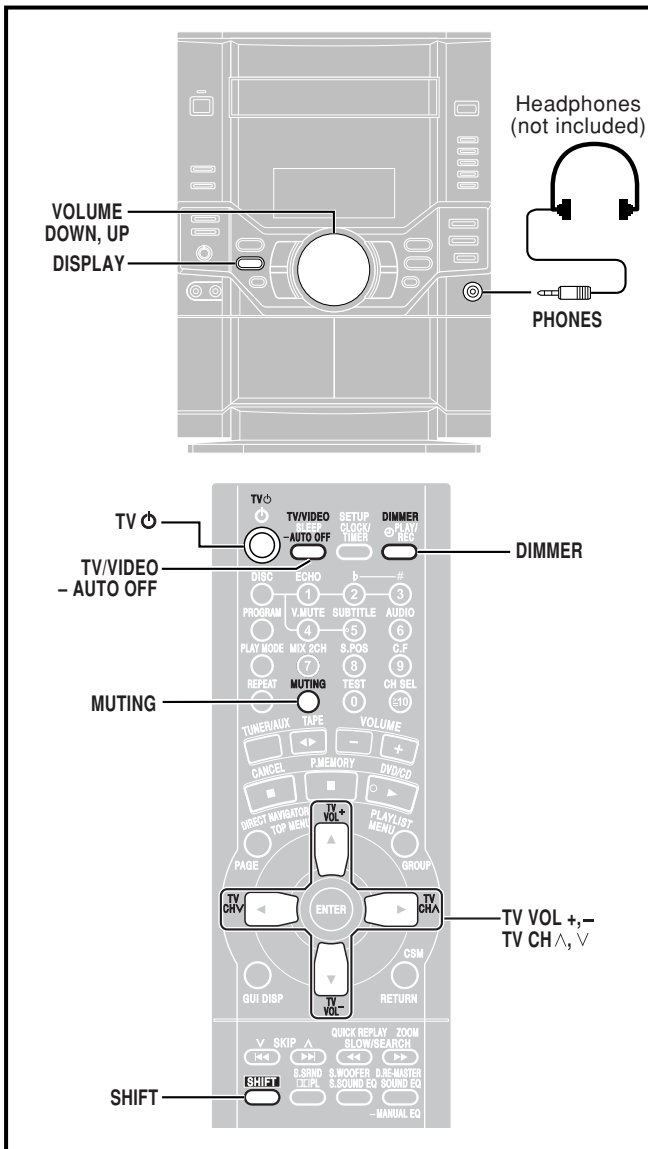

## Changing the sound range display

The unit's display shows the level of each sound range with the three types of display described below.

Press **[DISPLAY]** on the main unit.

Each time you press the button:

Normal display → Peak-hold display → Aurora display  
 ↑ (Off) ←

### a Normal display

This display indicates the strength of the sound in each tonal range.

### b Peak-hold display

The peak sound value of each sound range is held on the display for about one second after it occurs.

### c Aurora display

The peak sound value of each sound range is displayed in inverted form.

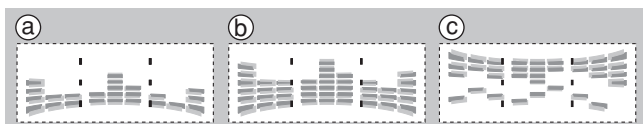

## Muting the volume

**Remote control only**

Press **[MUTING]**.



Volume is reduced to minimum.

**To cancel**

Press **[MUTING]** again or reduce the volume to minimum (–dB), then raise it to the required level.

Muting is also canceled when you switched the unit to standby.

## Dimming the display

**Remote control only**

Press **[SHIFT]+[DIMMER]**.

To return to the original brightness, press **[SHIFT]+[DIMMER]** again.

## Auto-off function

**Remote control only**

When disc or tape is selected as the source

To save power, the unit turns off if it is left unused for ten minutes.

This function does not work if the source is tuner or AUX.

Press and hold **[–AUTO OFF]**.

“AUTO OFF” is shown on the display.

The setting is maintained even if the unit is turned off.

If you select tuner or AUX as the source, “AUTO OFF” goes out. It comes on again when you select disc or tape.

**To cancel**

Press and hold **[–AUTO OFF]** again.

## Using headphones

- 1 Reduce the volume and connect the headphones (not included).

Headphone plug type: 3.5 mm stereo

- 2 Adjust headphone volume with **[VOLUME DOWN, UP]** on the main unit.

Audio is automatically switched to stereo (2-channel).

**Note**

Avoid listening for prolonged periods of time to prevent hearing damage.

## Operating a television

Face the remote control at the television for the following operations.

**Turning the television on/off**

Press **[SHIFT]+[TV⏻]**.

**Switching the television's video input mode**

Press **[SHIFT]+[TV/VIDEO]**.

**Changing channels**

Press **[SHIFT]+[TV CHV]** or **[SHIFT]+[TV CH^]**.

**Adjusting the volume**

Press **[SHIFT]+[TV VOL+]** or **[SHIFT]+[TV VOL–]**.





**Note**

Some models cannot be operated by this remote control.

# Changing settings

This chart shows the settings for this unit. Change the settings to suit your preferences and to suit the unit to the environment in which it is being used. These settings are retained in memory until they are changed, even if the unit is turned off. See page 37 for details on menu operation.

- Underlined items are the factory preset.

Menus	Items	Options
 <p><b>Disc</b></p>	<p><b>Audio</b> Choose the preferred audio language.</p>	<p>*<sup>1</sup> <u>English</u>    French    German    Italian    Spanish                      Portuguese    Swedish    Dutch    Original    Other* * * * *</p> <p>*<sup>2</sup> <u>English</u>    Chinese    Original    Other* * * * *</p> <p>Original:    The original language of each disc will be selected.                      Other * * * * *:    Input a code number with the numbered buttons (⇒ page 38).</p>
	<p><b>Subtitle</b> Choose the preferred subtitle language.</p>	<p>*<sup>1</sup> <u>Automatic</u>    English    French    German    Italian                      Spanish    Portuguese    Swedish    Dutch    Other* * * * *</p> <p>*<sup>2</sup> <u>Automatic</u>    English    Chinese    Other* * * * *</p> <p>Automatic:    If the language selected for "Audio" is not available, subtitles of that language will automatically appear if available on that disc.</p>
	<p><b>Menus</b> Choose the preferred language for disc menus.</p>	<p>*<sup>1</sup> <u>English</u>    French    German    Italian    Spanish                      Portuguese    Swedish    Dutch    Other* * * * *</p> <p>*<sup>2</sup> <u>English</u>    Chinese    Other* * * * *</p>
	<p><b>Ratings</b> (⇒ page 37) Set a ratings level to limit DVD-Video play.                      • The password screen is shown if you choose levels 0 to 7 or if you choose "Ratings" when levels 0 to 7 have been selected.                      • Select "Level 0" to prevent play of discs that do not have ratings levels recorded on them.</p>	<p><b>Setting ratings (When level 8 is selected)</b>  <u>8 No Limit</u>:    All DVD-Video can be played.                      1 to 7:    Prohibits play of DVD-Video with corresponding ratings recorded on them.                      0 Lock All:    Prohibits play of all DVD-Video.</p> <hr/> <p><b>Changing ratings (When level 0-7 is selected)</b>                      Unlock Player    Change Level                      Change Password    Temporary Unlock</p>
 <p><b>Video</b></p>	<p><b>TV Aspect</b> (⇒ page 10) Choose the setting to suit your television and preference.</p>	<p><u>4:3 Pan&amp;Scan</u>                      4:3 Letterbox                      16:9</p>
	<p><b>TV Type</b> (⇒ page 10) Select to suit the type of television.</p>	<p><u>Standard (Direct View TV)</u>                      CRT Projector                      LCD TV/Projector                      Projection TV                      Plasma TV</p>
	<p><b>Still Mode</b> Specify the type of picture shown when paused.</p>	<p><u>Automatic</u>                      Field                      Frame</p>
	<p><b>NTSC Disc Output</b> Choose whether PAL 60 or NTSC signals are output during playback of NTSC discs (⇒ page 5)</p>	<p><u>PAL60</u>: when connected to a PAL television.                      NTSC: when connected to an NTSC television.                      (For Southeast Asia: "NTSC" is the factory preset.)</p>
 <p><b>Audio</b></p>	<p><b>PCM Digital Output</b> <u>VK70D</u> (⇒ page 38)</p>	<p>Off    <u>Up to 48 kHz</u>    Up to 96 kHz    Up to 192 kHz</p>
	<p><b>Dolby Digital</b> <u>VK70D</u> (⇒ page 38)</p>	<p><u>Bitstream</u>                      PCM</p>
	<p><b>DTS Digital Surround</b> <u>VK70D</u> (⇒ page 38)</p>	<p><u>PCM</u>                      Bitstream</p>
	<p><b>MPEG</b> <u>VK70D</u> (⇒ page 38)*<sup>1</sup></p>	<p><u>PCM</u>                      Bitstream</p>
	<p><b>Speaker Setting</b> <u>VK90D</u> <u>VK80D</u> (⇒ page 37) Set the delay time for your center and surround speakers.</p>	<p>Multi-channel                      Center:                      0/1.3/2.6/3.9/5.3 ms                      Surround (L/R):    0/5.3/10.6/15.9 ms</p>
	<p><b>Dynamic Range Compression</b> (Dolby Digital only) Change the dynamic range for late night viewing.</p>	<p><u>Off</u>                      On: For clear dialog when listening at low volume.</p>
	<p><b>Audio during Search</b> Choose whether to have sound during search.</p>	<p><u>On</u>                      Off                      • This feature doesn't work for some discs.</p>
 <p><b>Display</b></p>	<p><b>Menu Language</b> Choose the preferred language for these menus and the on-screen messages.</p>	<p>*<sup>1</sup> <u>English</u>    Français    Deutsch    Italiano    Español                      Português    Svenska    Nederlands</p> <p>*<sup>2</sup> <u>English</u>    中文</p>
	<p><b>On-Screen Messages</b> Choose whether to show on-screen messages or not.</p>	<p><u>On</u>                      Off</p>
 <p><b>Others</b></p>	<p><b>HighMAT</b> Play HighMAT discs as HighMAT discs, or as regular WMA/MP3/JPEG discs.</p>	<p><u>Enable</u>: Play HighMAT discs as HighMAT discs.                      Disable: Play HighMAT discs as regular WMA/MP3/JPEG discs.</p>
	<p><b>Mixed Disc—Audio &amp; Stills</b> Select the type of file played on discs containing both JPEG and WMA/MP3.</p>	<p><u>Audio (MP3/WMA)</u>                      Stills (JPEG)</p>
	<p><b>DVD-Video Mode</b> Select how to play pictures contained on some DVD-Audio. The setting returns to "Off" when you remove the disc, turn the unit off or change the source.</p>	<p><u>Off</u>: DVD-Audio are played as DVD-Audio.                      On: DVD-Video contents found on DVD-Audio can be played.</p>
	<p><b>QUICK SETUP</b> (⇒ page 10) Answer questions to make basic settings.</p>	<p>Yes (Menu language, Audio language, Subtitle language, TV type, TV aspect, PCM Digital Output <u>VK70D</u>), <a href="http://www.DataSheet4U.com">DataSheet4U.com</a>                      No</p>

\*<sup>1</sup> For the Middle East, South Africa, Australia, N.Z. and Oceania

\*<sup>2</sup> For Southeast Asia

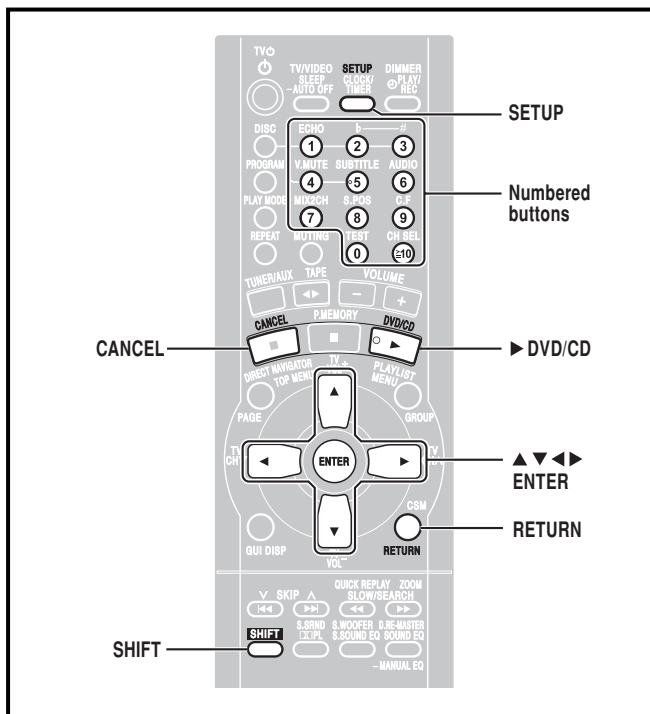

**Remote control only**

**Common procedures**

See page 36 for menu and option details.

**Preparation**

Press [▶ DVD/CD].

**1 Press [SHIFT]+[SETUP] to show the menus.**

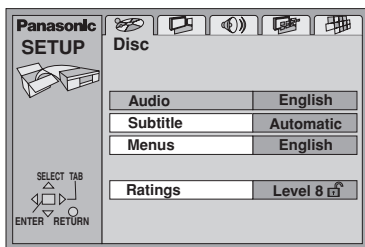

**2 Press [◀, ▶] to select the menu's tab.**

The screen changes to display the menu.

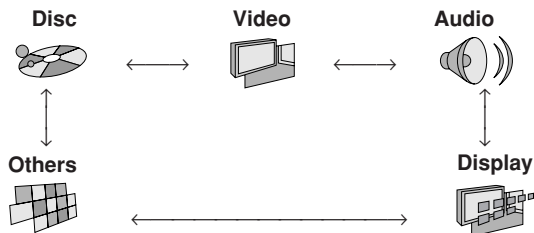

**3 Press [▲, ▼] to select the item you want to change and press [ENTER].**

**4 Press [◀, ▶, ▲, ▼] to select the option and press [ENTER].**

The screen now shows the menu again.

**To return to the previous screen**

Press [RETURN].

**When you are finished**

Press [SHIFT]+[SETUP].

**Entering a password (Ratings)**

**DVD-V**

The password screen is shown when you select levels 0 to 7.

1. Input a 4-digit password with the numbered buttons and press [ENTER].

- If you enter a wrong number, press [SHIFT]+[CANCEL] to erase it before you press [ENTER].
- The lock symbol appears closed to show the rating is locked.
- **Do not forget your password.**

2. Press [ENTER] to confirm the 4 digits.

Now, when you insert a DVD-Video that exceeds the ratings limit you set, a message appears on the television. Follow the on-screen instructions.

**Changing the delay time (Speaker Setting)**

**DVD-V**

(Dolby Digital, center and surround speakers only)

For optimum listening with 5.1-channel sound, all the speakers, except for the subwoofer, should be the same distance from the seating position. If you have to place the center or surround speakers closer to the seating position, adjust the delay time to make up for the difference.

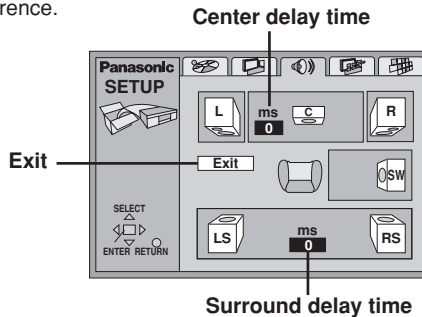

- 1 Press [▲, ▼] to select the delay time box and press [ENTER].
- 2 Press [▲, ▼] to adjust the delay time and press [ENTER].

**Values**

If distance (a) or (b) is greater than or equal to distance (c), set to "0". If distance (a) or (b) is less than distance (c), set as follows.

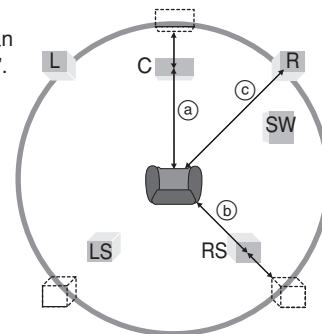

**(a) Center speaker**

Difference	Setting
Approx. 50 cm	1.3 ms
Approx. 100 cm	2.6 ms
Approx. 150 cm	3.9 ms
Approx. 200 cm	5.3 ms

**(b) Surround speakers**

Difference	Setting
Approx. 200 cm	5.3 ms
Approx. 400 cm	10.6 ms
Approx. 600 cm	15.9 ms

**When you are finished**

Press [◀] to select "Exit" and press [ENTER].

## Digital output

VK70D

RAM DVD-A DVD-V VCD CD WMA MP3

Change the settings when you have connected equipment through this unit's OPTICAL OUT terminal.

### PCM Digital Output

Select the maximum sampling frequency of PCM digital output. Check the digital input limitations of the equipment you connect.

**Off:** When not connected digitally

**Up to 48 kHz** (factory preset):

Signals over 48 kHz converted to 48 or 44.1 kHz

**Up to 96 kHz:** Signals over 96 kHz converted to 48 or 44.1 kHz

**Up to 192 kHz:** Signals up to 192 kHz are output

### Note

- Signals from copy-protected discs are converted to 48 or 44.1 kHz irrespective of the setting.
- Some equipment cannot handle sampling frequencies of 88.2 kHz, even if they can handle 96 kHz. Read your equipment's operating instructions for details.

### Dolby Digital, DTS Digital Surround and MPEG\*

**Bitstream** (Factory preset for Dolby Digital):

Select if the equipment you connected can decode the signal.

**PCM** (Factory preset for DTS Digital Surround and MPEG\*):

Select if the equipment you connected cannot decode the signal.

\*MPEG: Only for the Middle East, South Africa, Australia, N.Z. and Oceania.

### IMPORTANT

**If the equipment you connected cannot decode the signal, the setting must be changed to PCM. If not, signals the equipment cannot process will be output by this unit, causing high levels of noise which can damage your hearing and the speakers.**

### Language code list

Abkhazian:	6566	Hausa:	7265	Romanian:	8279
Afar:	6565	Hebrew:	7387	Russian:	8285
Afrikaans:	6570	Hindi:	7273	Samoaan:	8377
Albanian:	8381	Hungarian:	7285	Sanskrit:	8365
Ameharic:	6577	Icelandic:	7383	Scots Gaelic:	7168
Arabic:	6582	Indonesian:	7378	Serbian:	8382
Armenian:	7289	Interlingua:	7365	Serbo-Croatian:	8372
Assamese:	6583	Irish:	7165	Shona:	8378
Aymara:	6588	Italian:	7384	Sindhi:	8368
Azerbaijani:	6590	Japanese:	7465	Singhalese:	8373
Bashkir:	6665	Javanese:	7487	Slovak:	8375
Basque:	6985	Kannada:	7578	Slovenian:	8376
Bengali; Bangla:	6678	Kashmiri:	7583	Somali:	8379
Bhutani:	6890	Kazakh:	7575	Spanish:	6983
Bihari:	6672	Kirghiz:	7589	Sundanese:	8385
Breton:	6682	Korean:	7579	Swahili:	8387
Bulgarian:	6671	Kurdish:	7585	Swedish:	8386
Burmese:	7789	Laotian:	7679	Tagalog:	8476
Byelorussian:	6669	Latin:	7665	Tajik:	8471
Cambodian:	7577	Latvian, Lettish:	7686	Tamil:	8465
Catalan:	6765	Lingala:	7678	Tatar:	8484
Chinese:	9072	Lithuanian:	7684	Telugu:	8469
Corsican:	6779	Macedonian:	7775	Thai:	8472
Croatian:	7282	Malagasy:	7771	Tibetan:	6679
Czech:	6783	Malay:	7783	Tigrinya:	8473
Danish:	6865	Malayalam:	7776	Tonga:	8479
Dutch:	7876	Maltese:	7784	Turkish:	8482
English:	6978	Maori:	7773	Turkmen:	8475
Esperanto:	6979	Marathi:	7782	Twi:	8487
Estonian:	6984	Moldavian:	7779	Ukrainian:	8575
Faroese:	7079	Mongolian:	7778	Urdu:	8582
Fiji:	7074	Nauru:	7865	Uzbek:	8590
Finnish:	7073	Nepali:	7869	Vietnamese:	8673
French:	7082	Norwegian:	7879	Volapük:	8679
Frisian:	7089	Oriya:	7982	Welsh:	6789
Galician:	7176	Pashto, Pushto:	8083	Wolof:	8779
Georgian:	7565	Persian:	7065	Xhosa:	8872
German:	6869	Polish:	8076	Yiddish:	7473
Greek:	6976	Portuguese:	8084	Yoruba:	8979
Greenlandic:	7576	Punjabi:	8065	Zulu:	9085
Guarani:	7178	Quechua:	8185		
Gujarati:	7185	Rhaeto-Romance:	8277		

## Optional antenna connections

Use outdoor antenna if radio reception is poor.

### FM outdoor antenna

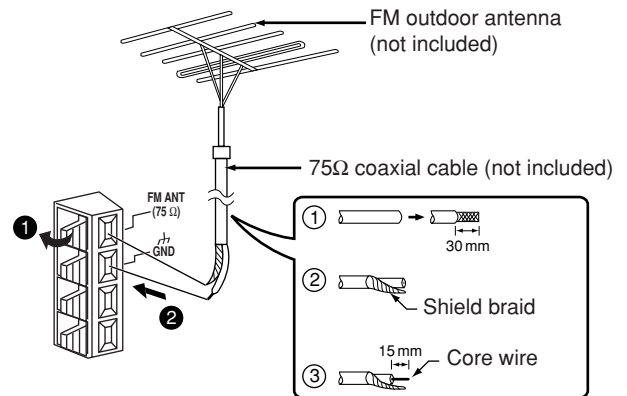

- Disconnect the FM indoor antenna.
- The antenna should be installed by a competent technician.

### AM outdoor antenna

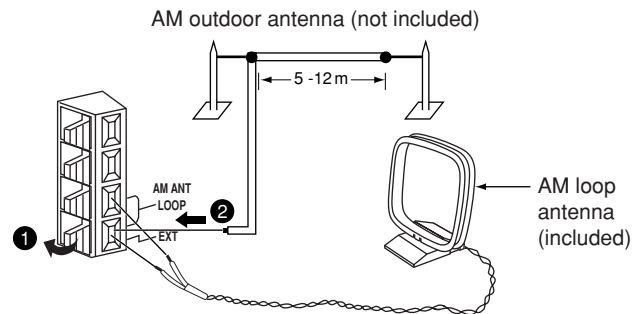

Run a piece of vinyl wire horizontally across a window or other convenient location. Leave the loop antenna connected.

### Note

Disconnect the outdoor antenna when the unit is not in use. Do not use the outdoor antenna during a lightning storm.

## Before connection

- Disconnect the AC power supply cord.
- Turn off all equipment and read the appropriate operating instructions.
- The equipment connections described are examples.
- Peripheral equipment and optional cables sold separately unless otherwise indicated.

## Home Theater—Enjoying more powerful sound

### VK70D

Enjoy the powerful movie theater and hall-like sound available with multiple channel audio found on DVDs by connecting an amplifier and speakers.

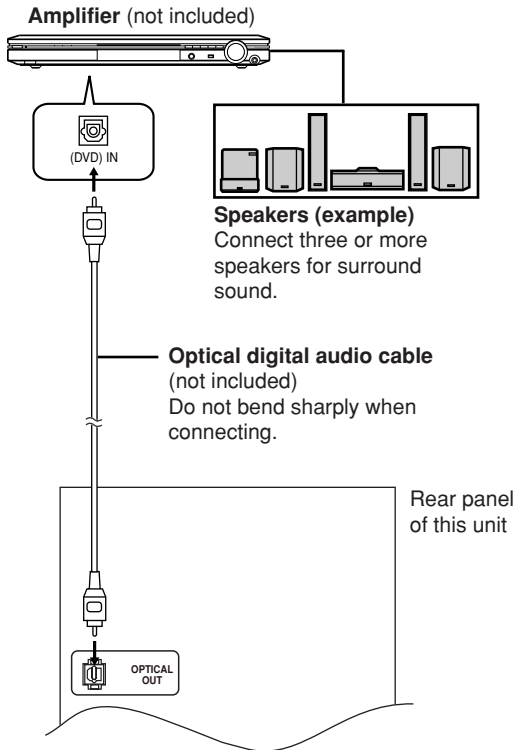

### To enjoy multi-channel surround sound

Connect an amplifier with a built-in decoder or a decoder-amplifier combination.

Change the settings in “Digital output” (⇒ page 38).

- You can only use DTS Digital Surround decoders that are compatible with DVD.

### Recording Output

- With DVD, the following conditions must be met: ① the disc doesn't have protection preventing digital recording, and ② the recording equipment can handle signals with a sampling frequency of 48 kHz.
- You cannot record WMA/MP3

When recording DVDs, make the following settings.

- Advanced surround: OFF (⇒ page 29).
  - PCM Digital Output: Up to 48 kHz (⇒ page 38).
  - Dolby Digital/DTS Digital Surround/MPEG\*: PCM (⇒ page 38).
- \*MPEG: Only for the Middle East, South Africa, Australia, N.Z. and Oceania.

## Using an external unit

You can playback the sound from a video cassette recorder, tape deck, laser disc player, etc., through this unit's speaker.

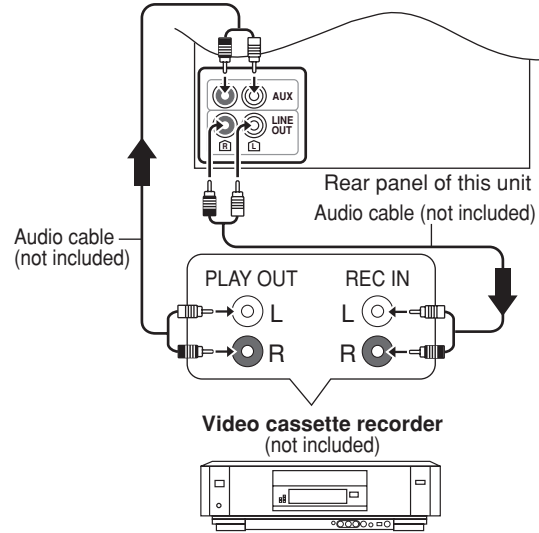

### When connecting a record player

We recommend using a record player with a built-in phono equalizer. If your player doesn't have a built-in equalizer, connect it first to a separate equalizer and then connect that to this unit.

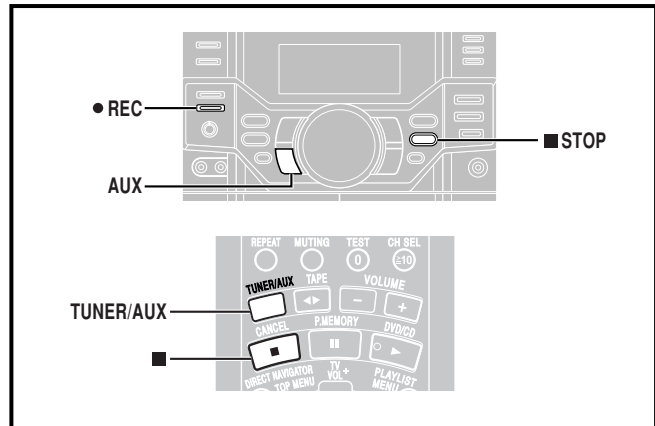

- 1 Press [AUX] (remote control: [TUNER/AUX])  
The unit comes on.

- 2 **For listening** : Proceed to step 3.  
**For recording** : Press [● REC] on the main unit (recording starts).  
Press [■ STOP] (remote control: [■]) to stop recording.

- 3 **Start playback from external source.**  
(For details, refer to the external unit's instruction manual.)

# Troubleshooting guide

Before requesting service, make the below checks. If you are in doubt about some of the check points, or if the remedies indicated in the chart do not solve the problem, consult your dealer for instructions.

## Power

Page

No power.	<ul style="list-style-type: none"> <li>Insert the AC power supply cord securely.</li> </ul>	9
The unit is automatically switched to the standby mode.	<ul style="list-style-type: none"> <li>The unit was switched to standby by the sleep timer.</li> </ul>	34

## Operation

No response when buttons pressed.	<ul style="list-style-type: none"> <li>Some operations may be prohibited by the disc.</li> <li>The unit may not be operating properly due to lightning, static electricity or some other external factor.</li> </ul> <p><b>Reset procedure:</b> Press [⏻/I] (remote control: [⏻]) to switch the unit to the standby mode and then back to ON. Alternatively, press [⏻/I] (remote control: [⏻]) to switch the unit to the standby mode, disconnect the AC power supply cord, and then reconnect it.</p>	— —
No operations can be performed with the remote control.	<ul style="list-style-type: none"> <li>Check that the batteries are installed correctly.</li> <li>The batteries are depleted: Replace them with new ones.</li> <li>Point the remote control at the remote control sensor and operate.</li> </ul>	9 9 —
Cannot switch on the television with the remote control.	<ul style="list-style-type: none"> <li>Press [SHIFT]+[TV ⏻] first to operate the television.</li> </ul>	—
Play doesn't start (or stops immediately) when you press [▶/II DVD/CD] (remote control: [▶ DVD/CD])	<ul style="list-style-type: none"> <li>Condensation has formed: Wait 1 to 2 hours for it to evaporate.</li> <li>This unit cannot play discs other than the ones listed in these operating instructions.</li> <li>You can only play DVD-Video if their region number is the same or includes the same region number as the unit or if DVD-Video is marked "ALL". Confirm the region number for the unit on the rear panel.</li> <li>The disc may be dirty and may require cleaning.</li> <li>Ensure that the disc is installed with the label of the side to be played facing upwards.</li> <li>Check that the DVD-RAM has something recorded on it.</li> </ul>	— 5 Cover 5 14 —
Cannot select alternative languages.	<ul style="list-style-type: none"> <li>This function is dependent on software availability.</li> <li>Try selecting from the disc's menu if one is available.</li> </ul>	— 14
No menu play.	<ul style="list-style-type: none"> <li>This function is dependent on software availability.</li> </ul>	—
No subtitles.	<ul style="list-style-type: none"> <li>This function is dependent on software availability.</li> <li>Subtitles are cleared from the television. Display the subtitles.</li> </ul>	— 18
The position of the subtitles is incorrect.	<ul style="list-style-type: none"> <li>Change the position of the subtitles with "Subtitle Position" in the GUI screen.</li> </ul>	25
Soundtrack and/or subtitle language is not the one selected with the SETUP menus.	<ul style="list-style-type: none"> <li>This function is dependent on software availability.</li> </ul>	—
Cannot change angle.	<ul style="list-style-type: none"> <li>This function is dependent on software availability. Even if a disc has a number of angles recorded, these angles may be recorded for specific scenes only.</li> </ul>	—
The SETUP menu cannot be accessed.	<ul style="list-style-type: none"> <li>Select "DVD/CD" as the source.</li> <li>Cancel all group, program and random play.</li> </ul>	— 16
Cannot add markers.	<ul style="list-style-type: none"> <li>You cannot add markers while playing a play list or if the disc's play time doesn't appear on the unit's display.</li> </ul>	—
There are already markers. <b>RAM</b>	<ul style="list-style-type: none"> <li>The unit reads and displays the markers added with a DVD video recorder. You can clear them but reappear when you switch the unit to standby, change the source, or change the disc.</li> </ul>	—
Marker numbers I added are different when I call them up. <b>RAM</b>	<ul style="list-style-type: none"> <li>The unit numbers markers by time so they change when you add and delete them.</li> </ul>	—
Cannot select random or program play.	<ul style="list-style-type: none"> <li>You cannot select random or program play with some DVD-Video.</li> </ul>	—
Folders deeper than the eighth layer on a data disc are not displayed correctly.	<ul style="list-style-type: none"> <li>Folders deeper than the eighth layer are displayed as the eighth layer.</li> </ul>	—
You have forgotten your ratings password. Reset all the SETUP settings to Factory Preset.	<ul style="list-style-type: none"> <li>While stopped and "DVD/CD" is the source, press and hold [■ STOP] on the unit and [≥10] on the remote control for about 3 seconds until "Initialized" disappears from the television. Turn the unit off and on again. All settings will return to the default values.</li> </ul>	—

Reference



**Sound**

<b>No sound. Distorted sound.</b>	<ul style="list-style-type: none"> <li>• Check the connections.</li> <li>• Turn the volume up.</li> <li>• Turn muting off.</li> <li>• Switch off the unit, determine and correct the cause, then switch the unit on. Causes include: <ul style="list-style-type: none"> <li>– Shorting (bare wires touching) of positive and negative speaker wires.</li> <li>– Using speakers with an impedance lower than that rated for this unit.</li> <li>– Straining of the speakers through excessive volume or power.</li> <li>– Using the unit in a hot environment without proper ventilation.</li> </ul> </li> </ul>	7 — 35 —
<b>Humming heard during play.</b>	<ul style="list-style-type: none"> <li>• An AC power supply cord or fluorescent light is near the subwoofer. Keep other appliances and cords away from the subwoofer.</li> </ul>	—

**Picture**

<b>Picture distorted.</b>	<ul style="list-style-type: none"> <li>• Some distortion is normal during SEARCH.</li> </ul>	—
<b>No picture.</b>	<ul style="list-style-type: none"> <li>• Check the connection.</li> <li>• Make sure the television is on.</li> <li>• Ensure the television's video input setting (e.g., VIDEO 1) is correct.</li> </ul>	8 — —
<b>The picture shown on the television is not normal. (The sides of the picture are cut off, the picture is stretched horizontally, or black bands appear at the top and bottom of the screen.)</b>	<ul style="list-style-type: none"> <li>• Go to Video in the SETUP menus, and change "TV Aspect" to suit your television.</li> <li>• Use the television to change the aspect to the correct one. <b>If your television cannot change the aspect</b>, try changing 4:3 Aspect with the GUI screen.</li> <li>• Ensure that the unit is connected directly to the television, and is not connected through a video cassette recorder.</li> <li>• Connect to the component video (480i) input terminals on a television compatible with this unit's copy guard system.</li> <li>• Change the size with the variable zoom function.</li> </ul>	37 25 — 8 19
<b>Picture quality is poor.</b>	<ul style="list-style-type: none"> <li>• Check the settings in the GUI screen's Picture Menu.</li> </ul>	25
<b>The picture on the television disappears or stripes appear on the screen.</b>	<ul style="list-style-type: none"> <li>• Mobile telephone chargers can cause some disturbance.</li> <li>• The location and orientation of the antenna are incorrect. If you are using an indoor antenna, change to an outdoor antenna.</li> <li>• The television antenna wire is too close to the unit. Separate the antenna wire of the television from the unit.</li> </ul>	— 38 —
<b>Menus not displayed correctly.</b>	<ul style="list-style-type: none"> <li>• Change the zoom ratio to "x1.00".</li> <li>• With the GUI screen, change "Subtitle Position" to "0" or change "4:3 Aspect" to "Normal".</li> </ul>	19 24, 25

**Listening to the radio**

<b>Noise is heard. "ST" flickers or doesn't light. Sound is distorted.</b>	<ul style="list-style-type: none"> <li>• Adjust the position of the FM or AM antenna.</li> <li>• Use an outdoor antenna.</li> </ul>	— 38
<b>A beat sound is heard.</b>	<ul style="list-style-type: none"> <li>• Turn the television off or separate it from the unit.</li> </ul>	—
<b>A low hum is heard during AM broadcasts.</b>	<ul style="list-style-type: none"> <li>• Separate the antenna from other cables and cords.</li> </ul>	—

**Using the cassette deck**

<b>Poor quality sound.</b>	<ul style="list-style-type: none"> <li>• Clean the heads.</li> </ul>	42
<b>Recording is not possible.</b>	<ul style="list-style-type: none"> <li>• If the erasure prevention tabs have been removed, cover the holes with adhesive tape.</li> </ul>	31

**Remote control**

<b>Remote control doesn't work.</b>	<ul style="list-style-type: none"> <li>• Check the batteries are inserted correctly.</li> <li>• Replace the batteries if they are worn.</li> </ul>	9 —
-------------------------------------	--	--------

Unit displays

The display is dark.	<ul style="list-style-type: none"> <li>Press [SHIFT]+[DIMMER] to brighten the display.</li> </ul>	35
“NO PLAY”	<ul style="list-style-type: none"> <li>You inserted a disc the unit cannot play; insert one that can.</li> <li>You inserted a blank DVD-RAM.</li> </ul>	5 —
“NO DISC”	<ul style="list-style-type: none"> <li>You haven't inserted a disc; insert one.</li> <li>You haven't inserted the disc correctly; insert it correctly.</li> </ul>	— 14
“F61”	<ul style="list-style-type: none"> <li>Check and correct the speaker cord connections. If this does not fix the problem, there is a power supply problem. Consult the dealer.</li> </ul>	7
“DVD U11”	<ul style="list-style-type: none"> <li>Disc is dirty. Wipe it clean.</li> </ul>	5
“ERROR”	<ul style="list-style-type: none"> <li>Incorrect operation performed. Read the instructions and try again.</li> </ul>	—
“DVD H□□” □□ stands for a number.	<ul style="list-style-type: none"> <li>Trouble may have occurred. The number following “H” depends on the status of the unit. <b>Reset procedure:</b> Press [⏻/I] (remote control: [⏻]) to switch the unit to the standby mode and then back to ON. Alternatively, press [⏻/I] (remote control: [⏻]) to switch the unit to the standby mode, disconnect the AC power supply cord, and then reconnect it.</li> <li>If the service numbers fail to clear, note the service number and contact a qualified service person.</li> </ul>	— —

Reference

Television displays

No on-screen display.	<ul style="list-style-type: none"> <li>Go to Display in the SETUP menus, and select “On” for “On-Screen Messages”.</li> </ul>	37
GUI screen not displayed or only partially displayed on the television.	<ul style="list-style-type: none"> <li>Press [▲, ▼] while the rightmost icon is highlighted to move them down.</li> </ul>	23
The disc's menu is displayed in a different language.	<ul style="list-style-type: none"> <li>Go to Disc in the SETUP menus, and select the preferred language for “Menus”.</li> </ul>	37
“Cannot display group xx, picture xx.”	<ul style="list-style-type: none"> <li>You are trying to display incompatible pictures.</li> </ul>	—

## Safety precautions

### Placement

Set the unit up on an even surface away from direct sunlight, high temperatures, high humidity, and excessive vibration. These conditions can damage the cabinet and other components, thereby shortening the unit's service life.

Do not place heavy items on the unit.

### Voltage

Do not use high voltage power sources. This can overload the unit and cause a fire.

Do not use a DC power source. Check the source carefully when setting the unit up on a ship or other place where DC is used.

### Power cord protection

Ensure the AC power cord is connected correctly and not damaged. Poor connection and lead damage can cause fire or electric shock. Do not pull, bend, or place heavy items on the lead.

Grasp the plug firmly when unplugging the lead. Pulling the AC power cord can cause electric shock.

Do not handle the plug with wet hands. This can cause electric shock.

### Foreign matter

Do not let metal objects fall inside the unit. This can cause electric shock or malfunction.

Do not let liquids get into the unit. This can cause electric shock or malfunction. If this occurs, immediately disconnect the unit from the power supply and contact your dealer.

Do not spray insecticides onto or into the unit. They contain flammable gases which can ignite if sprayed into the unit.

### Service

Do not attempt to repair this unit by yourself. If sound is interrupted, indicators fail to light, smoke appears, or any other problem that is not covered in these instructions occurs, disconnect the AC power cord and contact your dealer or an authorized service center. Electric shock or damage to the unit can occur if the unit is repaired, disassembled or reconstructed by unqualified persons.

Extend operating life by disconnecting the unit from the power source if it is not to be used for a long time.

## Maintenance

### To clean this unit, wipe with a soft, dry cloth.

- Never use alcohol, paint thinner or benzene to clean this unit.
- Before using chemically treated cloth, read the instructions that came with the cloth carefully.

### For a cleaner, crisper sound (cassette deck)

Clean the heads regularly to assure good quality playback and recording. Use a cleaning tape (not included).

## AMPLIFIER SECTION

### VK90D

RMS Output Power both channel driven: 10 % Total Harmonic Distortion

1 kHz Front-HI CH	80 W per channel (6 Ω)
100 Hz Front-LOW CH	60 W (12 Ω)
1 kHz Surround CH	40 W per channel (8 Ω)
1 kHz Center CH	100 W (8 Ω)
100 Hz Subwoofer CH	100 W per channel (6 Ω)

Total RMS Dolby Digital Mode Power 600 W

PMPO Output Power 7000 W

Input sensitivity/Input Impedance

AUX 250 mV, 13.3 kΩ

**For the Middle East, South Africa and Southeast Asia**

MIC 0.7 mV, 680 Ω

### VK80D

RMS Output Power both channel driven: 10 % Total Harmonic Distortion

1 kHz Front CH	70 W per channel (6 Ω)
1 kHz Surround CH	40 W per channel (8 Ω)
1 kHz Center CH	70 W (8 Ω)
100 Hz Subwoofer CH	70 W (6 Ω)

Total RMS Dolby Digital Mode Power 360 W

PMPO Output Power 4200 W

Input sensitivity/Input Impedance

AUX 250 mV, 13.3 kΩ

**For the Middle East, South Africa and Southeast Asia**

MIC 0.7 mV, 680 Ω

### VK70D

RMS Output Power both channel driven: 10 % Total Harmonic Distortion

1 kHz Front CH 100 W per channel (6 Ω)

Total RMS Dolby Digital Mode Power 200 W

PMPO Output Power 2200 W

Input sensitivity/Input Impedance

AUX 250 mV, 13.3 kΩ

**For the Middle East, South Africa and Southeast Asia**

MIC 0.7 mV, 680 Ω

## FM TUNER SECTION

Frequency range 87.50 – 108.00 MHz (50 kHz step)

Sensitivity 2.5 μV (IHF)

S/N 26 dB 2.2 μV

Antenna terminals 75 Ω (unbalanced)

Preset station 15

## AM TUNER SECTION

Frequency range

**For the Middle East, South Africa and Southeast Asia**

522 – 1629 kHz (9 kHz step)

520 – 1630 kHz (10 kHz step)

**For Australia, N.Z. and Oceania**

522 – 1629 kHz (9 kHz step)

**For the Middle East, South Africa and Southeast Asia**

AM sensitivity S/N 20dB at 1000 kHz 560 μV/m

**For Australia, N.Z. and Oceania**

AM sensitivity S/N 20dB at 999 kHz 560 μV/m

Preset station 15

## CASSETTE DECK SECTION

Track system 4 Track, 2 Channel

Heads

Record/playback Solid permalloy head

Erasure Double gap ferrite head

Motor DC servo motor

Recording system AC bias 100 kHz

Erasing system AC erase 100 kHz

Tape speed 4.8 cm/s (1 7/8 ips)

Overall frequency response (+3, –6 dB) at DECK OUT

Normal (TYPE I) 35 Hz –14 kHz

S/N ratio 50 dB (A weighted)

Wow and flutter 0.18% (WRMS)

Fast forward and rewind time Approx. 120 seconds with

C-60 cassette tape

## DISC SECTION

Disc played (one layer per side)

DVD-Video/Audio

8 cm/12 cm, single/double-sided, single/double-layer

DVD-RAM/R (DVD-Video formatted discs)

CD-DA/VCD/MP3/WMA 8 cm/12 cm, CD-R/RW

SVCD (Conforming to IEC62107)

HighMAT Level 2 (Audio and Image)

JPEG-Exif Ver 2.1 JPEG Baseline files

Video

Signal system PAL625/50, PAL525/60, NTSC

Output level Composite video 1 Vp-p (75 Ω)

S-video Y 1 Vp-p (75 Ω)

S-video C 0.3 Vp-p (75 Ω) (PAL)

0.286 Vp-p (75 Ω) (NTSC)

Component video 1 Vp-p (Y) (75 Ω)

0.7 Vp-p (PB/CB PR/CR) (75 Ω)

Audio

Sampling frequency

CD 44.1 kHz

MP3 32 kHz, 44.1 kHz, 48 kHz

DVD-Video 48 kHz, 96 kHz

DVD-Audio 192 kHz

MP3

Bitrate 32 – 320 kbps

Decoding 16/20/24 bit linear

Number of channels

**VK90D VK80D** 5.1 ch (FL, FR, SL, SR, C, SW)

**VK70D** Stereo

Frequency response 20 Hz–20 kHz (+1, –2 dB)

Pick up

Beam Source Semiconductor Laser

Wavelength

CD/VCD 780 nm

DVD 658 nm

Wow and flutter

Less than possible measurement data

Digital filter

8 fs

D/A converter

Delta sigma DAC

**VK70D**

Digital audio output

Optical digital output Optical terminal

## SPEAKER SECTION

**VK90D** Front speakers

Type

3 Way, 3 Speaker

Speaker(s)

Super woofer 16 cm cone type

Woofer 12 cm cone type

Tweeter 6 cm cone type

Impedance

High 6 Ω / Low 12 Ω

Input power

High 200 W (Music) / Low 130 W (Music)

Output sound pressure level

85 dB/W (1.0 m)

Cross over frequency

150 Hz, 5 kHz

Frequency range

29 Hz–21 kHz (–16 dB)

43 Hz–21 kHz (–10 dB)

## Specifications

www.DataSheet4U.com

### VK80D Front speakers

Type	3 Way, 3 Speaker
Speaker(s)	
Woofer	16 cm cone type
Mid range	12 cm cone type
Tweeter	6 cm cone type
Impedance	6 Ω
Input power	180 W (Music)
Output sound pressure level	87 dB/W (1.0 m)
Cross over frequency	250 Hz, 5 kHz
Frequency range	32 Hz–22 kHz (–16 dB) 52 Hz–20 kHz (–10 dB)

### VK90D VK80D

Dimensions (WxHxD)	253 x 368 x 295 mm
Mass	5.3 kg

### VK70D Front speakers

Type	2 Way, 2 Speaker
Speaker(s)	
Woofer	16 cm cone type
Tweeter	6 cm cone type
Impedance	6 Ω
Input power	200 W (Music)
Output sound pressure level	85 dB/W (1.0 m)
Crossover frequency	5 kHz
Frequency range	39 Hz–21 kHz (–16 dB) 55 Hz–20 kHz (–10 dB)
Dimensions (WxHxD)	220 x 330 x 227 mm
Mass	3.2 kg

### VK90D VK80D Center speaker

Type	1 Way, 2 Speaker
Speaker	
Full range	10 cm cone type
Impedance	8 Ω
Input power	210 W (Music)
Output sound pressure level	86 dB/W (1.0 m)
Frequency range	59 Hz–20 kHz (–16 dB) 75 Hz–20 kHz (–10 dB)
Dimensions (WxHxD)	372 x 144 x 183 mm
Mass	2.3 kg

### VK90D VK80D VK70D Surround speakers

Type	1 Way, 1 Speaker
Speaker	
Full range	10 cm cone type
Impedance	8 Ω
Input power	80 W (Music)
Output sound pressure level	83 dB/W (1.0 m)
Frequency range	53 Hz–20 kHz (–16 dB) 75 Hz–20 kHz (–10 dB)
Dimensions (WxHxD)	205 x 145 x 160 mm
Mass	1.3 kg

### VK90D VK80D Subwoofer

Type	1 Way, 2 Speaker
Speaker	
Subwoofer	16 cm cone type
Impedance	6 Ω
Input power	200 W (Music)
Output sound pressure level	85 dB/W (1.0 m)
Frequency range	24 Hz–4.7 kHz (–16 dB) 51 Hz–4 kHz (–10 dB)
Dimensions (WxHxD)	230 x 372 x 358 mm
Mass	6.0 kg

## GENERAL

### For the Middle East, South Africa and Southeast Asia

Power supply	AC 110V/127V/220–230V/240V, 50/60 Hz
--------------	--------------------------------------

### For Australia, N.Z. and Oceania

Power supply	AC 230~240V, 50 Hz
--------------	--------------------

## Power consumption

### For the Middle East, South Africa and Southeast Asia

VK90D	313 W
VK80D	275 W
VK70D	146 W

### For Australia, N.Z. and Oceania

VK90D	286 W
VK80D	256 W
VK70D	138 W

Dimensions (WxHxD)	250 x 330 x 370 mm
Mass	

VK90D	10 kg
VK80D	9.8 kg
VK70D	8.0 kg

Power consumption in standby mode:	0.9W
------------------------------------	------

## Note:

- Specifications are subject to change without notice. Mass and dimensions are approximate.
- Total harmonic distortion is measured by the digital spectrum analyzer.

Manufactured under license from Dolby Laboratories.  
“Dolby”, “Pro Logic” and the double-D symbol are trademarks of Dolby Laboratories.

Manufactured under license from Digital Theater Systems, Inc. US Pat. No. 5,451,942, 5,956,674, 5,974,380, 5,978,762 and other world-wide patents issued and pending. “DTS” and “DTS Digital Surround” are registered trademarks of Digital Theater Systems, Inc. Copyright 1996, 2000 Digital Theater Systems, Inc. All rights reserved.

This product incorporates copyright protection technology that is protected by method claims of certain U.S. patents and other intellectual property rights owned by Macrovision Corporation and other rights owners. Use of this copyright protection technology must be authorized by Macrovision Corporation, and is intended for home and other limited viewing uses only unless otherwise authorized by Macrovision Corporation. Reverse engineering or disassembly is prohibited.

**Matsushita Electric Industrial Co., Ltd.**  
Web Site: <http://www.panasonic.co.jp/global/>

