

# SA5.0CA Series

## 500 Watt Peak Power MiniMOSORB™ Zener Transient Voltage Suppressors

### Bidirectional\*

The SA5.0CA series is designed to protect voltage sensitive components from high voltage, high-energy transients. They have excellent clamping capability, high surge capability, low zener impedance and fast response time. The SA5.0CA series is supplied in ON Semiconductor's exclusive, cost-effective, highly reliable Surmetic™ axial leaded package and is ideally-suited for use in communication systems, numerical controls, process controls, medical equipment, business machines, power supplies and many other industrial/consumer applications.

#### Specification Features:

- Working Peak Reverse Voltage Range – 5.0 to 170 V
- Peak Power – 500 Watts @ 1 ms
- ESD Rating of Class 3 (>16 KV) per Human Body Model
- Maximum Clamp Voltage @ Peak Pulse Current
- Low Leakage < 1  $\mu$ A above 8.5 V
- UL 497B for Isolated Loop Circuit Protection
- Maximum Temperature Coefficient Specified
- Response Time is typically < 1 ns

#### Mechanical Characteristics:

**CASE:** Void-free, Transfer-molded, Thermosetting plastic

**FINISH:** All external surfaces are corrosion resistant and leads are readily solderable

#### MAXIMUM LEAD TEMPERATURE FOR SOLDERING PURPOSES:

230 °C, 1/16" from the case for 10 seconds

**POLARITY:** Cathode band does not imply polarity

**MOUNTING POSITION:** Any

#### MAXIMUM RATINGS

Rating	Symbol	Value	Unit
Peak Power Dissipation (Note 1) @ $T_L \leq 25^\circ\text{C}$	$P_{PK}$	500	Watts
Steady State Power Dissipation @ $T_L \leq 75^\circ\text{C}$ , Lead Length = 3/8" Derated above $T_L = 75^\circ\text{C}$	$P_D$	3.0	Watts
		30	mW/°C
Thermal Resistance, Junction-to-Lead	$R_{\theta JL}$	33.3	°C/W
Operating and Storage Temperature Range	$T_J, T_{stg}$	- 55 to +175	°C

1. Nonrepetitive current pulse per Figure 3 and derated above  $T_A = 25^\circ\text{C}$  per Figure 2.

\*Please see SA5.0A to SA170A for Unidirectional devices.



ON Semiconductor®

<http://onsemi.com>

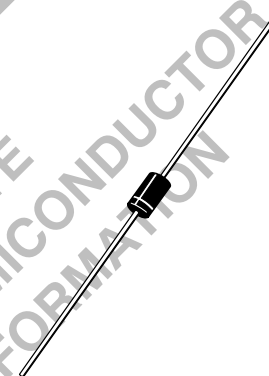

AXIAL LEAD  
CASE 59  
PLASTIC

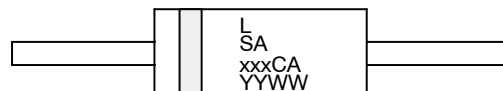

L = Assembly Location  
SAxxxCA = ON Device Code  
YY = Year  
WW = Work Week

#### ORDERING INFORMATION

Device	Package	Shipping
SAxxxCA	Axial Lead	1000 Units/Box
SAxxxCARL*	Axial Lead	5000/Tape & Reel

\*SA6.5CA, SA48CA, SA64CA, and SA78CA Not Available in 5000/Tape & Reel

Devices listed in **bold, italic** are ON Semiconductor **Preferred** devices. Preferred devices are recommended choices for future use and best overall value.

## SA5.0CA Series

### ELECTRICAL CHARACTERISTICS

( $T_A = 25^\circ\text{C}$  unless otherwise noted)

Symbol	Parameter
$I_{PP}$	Maximum Reverse Peak Pulse Current
$V_C$	Clamping Voltage @ $I_{PP}$
$V_{RWM}$	Working Peak Reverse Voltage
$I_R$	Maximum Reverse Leakage Current @ $V_{RWM}$
$V_{BR}$	Breakdown Voltage @ $I_T$
$I_T$	Test Current
$\Theta V_{BR}$	Maximum Temperature Variation of $V_{BR}$

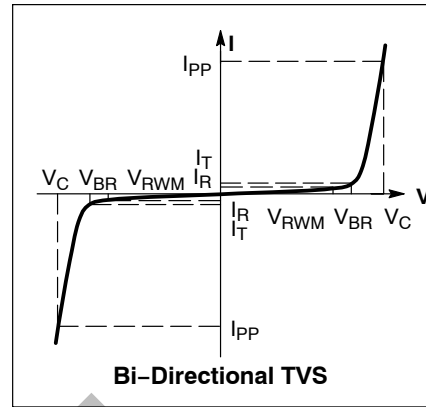

OBSOLETE

THIS DEVICE IS OBSOLETE  
PLEASE CONTACT YOUR ON SEMICONDUCTOR  
REPRESENTATIVE FOR INFORMATION

## SA5.0CA Series

### ELECTRICAL CHARACTERISTICS (T<sub>A</sub> = 25°C unless otherwise noted.)

Device	Device Marking	V <sub>RWM</sub> (Note 2) (Volts)	I <sub>R</sub> @ V <sub>RWM</sub> (μA)	Breakdown Voltage			V <sub>C</sub> @ I <sub>PP</sub> (Note 4)		ΘV <sub>BR</sub> (mV/°C)	
				V <sub>BR</sub> (Note 3) (Volts)			@ I <sub>T</sub> (mA)	V <sub>C</sub> (Volts)		I <sub>PP</sub> (A)
				Min	Nom	Max				
SA5.0CA	SA5.0CA	5	600	6.4	6.7	7	10	9.2	54.3	5
SA6.0CA	SA6.0CA	6	600	6.67	7.02	7.37	10	10.3	48.5	5
<b>SA6.5CA*</b>	<b>SA6.5CA*</b>	<b>6.5</b>	<b>400</b>	<b>7.22</b>	<b>7.60</b>	<b>7.98</b>	<b>10</b>	<b>11.2</b>	<b>44.7</b>	<b>5</b>
SA7.0CA	SA7.0CA	7	150	7.78	8.19	8.6	10	12	41.7	6
SA7.5CA	SA7.5CA	7.5	50	8.33	8.77	9.21	1	12.9	38.8	7
SA8.0CA	SA8.0CA	8	25	8.89	9.36	9.83	1	13.6	36.7	7
SA8.5CA	SA8.5CA	8.5	5	9.44	9.92	10.4	1	14.4	34.7	8
SA9.0CA	SA9.0CA	9	1	10	10.55	11.1	1	15.4	32.5	9
SA10CA	SA10CA	10	1	11.1	11.7	12.3	1	17	29.4	10
SA11CA	SA11CA	11	1	12.2	12.85	13.5	1	18.2	27.4	11
<b>SA12CA</b>	<b>SA12CA</b>	<b>12</b>	<b>1</b>	<b>13.3</b>	<b>14</b>	<b>14.7</b>	<b>1</b>	<b>19.9</b>	<b>25.1</b>	<b>12</b>
<b>SA13CA</b>	<b>SA13CA</b>	<b>13</b>	<b>1</b>	<b>14.4</b>	<b>15.15</b>	<b>15.9</b>	<b>1</b>	<b>21.5</b>	<b>23.2</b>	<b>13</b>
SA14CA	SA14CA	14	1	15.6	16.4	17.2	1	23.2	21.5	14
<b>SA15CA</b>	<b>SA15CA</b>	<b>15</b>	<b>1</b>	<b>16.7</b>	<b>17.6</b>	<b>18.5</b>	<b>1</b>	<b>24.4</b>	<b>20.6</b>	<b>16</b>
SA16CA	SA16CA	16	1	17.8	18.75	19.7	1	26	19.2	17
SA17CA	SA17CA	17	1	18.9	19.9	20.9	1	27.6	18.1	19
<b>SA18CA</b>	<b>SA18CA</b>	<b>18</b>	<b>1</b>	<b>20</b>	<b>21.05</b>	<b>22.1</b>	<b>1</b>	<b>29.2</b>	<b>17.2</b>	<b>20</b>
SA20CA	SA20CA	20	1	22.2	23.35	24.5	1	32.4	15.4	23
SA22CA	SA22CA	22	1	24.4	25.65	26.9	1	35.5	14.1	25
<b>SA24CA</b>	<b>SA24CA</b>	<b>24</b>	<b>1</b>	<b>26.7</b>	<b>28.1</b>	<b>29.5</b>	<b>1</b>	<b>38.9</b>	<b>12.8</b>	<b>28</b>
SA26CA	SA26CA	26	1	28.9	30.4	31.9	1	42.1	11.9	30
SA28CA	SA28CA	28	1	31.1	32.75	34.4	1	45.4	11	31
SA30CA	SA30CA	30	1	33.3	35.05	36.8	1	48.4	10.3	36
SA33CA	SA33CA	33	1	36.7	38.65	40.6	1	53.3	9.4	39
SA36CA	SA36CA	36	1	40	42.1	44.2	1	58.1	8.6	41
SA40CA	SA40CA	40	1	44.4	46.55	49.1	1	64.5	7.8	46
SA43CA	SA43CA	43	1	47.8	50.3	52.8	1	69.4	7.2	50
SA45CA	SA45CA	45	1	50	52.65	55.3	1	72.7	6.9	52
SA48CA*	SA48CA*	48	1	53.3	56.1	58.9	1	77.4	6.5	56
SA51CA	SA51CA	51	1	56.7	59.7	62.7	1	82.4	6.1	61
SA58CA	SA58CA	58	1	64.4	67.8	71.2	1	93.6	5.3	70
SA60CA	SA60CA	60	1	66.7	70.2	73.7	1	96.8	5.2	71
SA64CA*	SA64CA*	64	1	71.1	74.85	78.6	1	103	4.9	76
SA70CA	SA70CA	70	1	77.8	81.9	86	1	113	4.4	85
SA78CA*	SA78CA*	78	1	86.7	91.25	95.8	1	126	4.0	95
SA85CA	SA85CA	85	1	94.4	99.2	104	1	137	3.6	103
SA90CA	SA90CA	90	1	100	105.5	111	1	146	3.4	110
SA100CA	SA100CA	100	1	111	117	123	1	162	3.1	123
SA110CA	SA110CA	110	1	122	128.5	135	1	177	2.8	133
SA120CA	SA120CA	120	1	133	140	147	1	193	2.5	146
SA130CA	SA130CA	130	1	144	151.5	159	1	209	2.4	158
SA150CA	SA150CA	150	1	167	176	185	1	243	2.1	184

**NOTES:**

2. MiniMOSORB™ transient suppressors are normally selected according to the maximum working peak reverse voltage (V<sub>RWM</sub>), which should be equal to or greater than the dc or continuous peak operating voltage level.
3. V<sub>BR</sub> measured at pulse test current I<sub>T</sub> at an ambient temperature of 25°C.
4. Surge current waveform per Figure 3 and derate per Figures 1 and 2.

\*Not Available in the 5,000/Tape & Reel.

# SA5.0CA Series

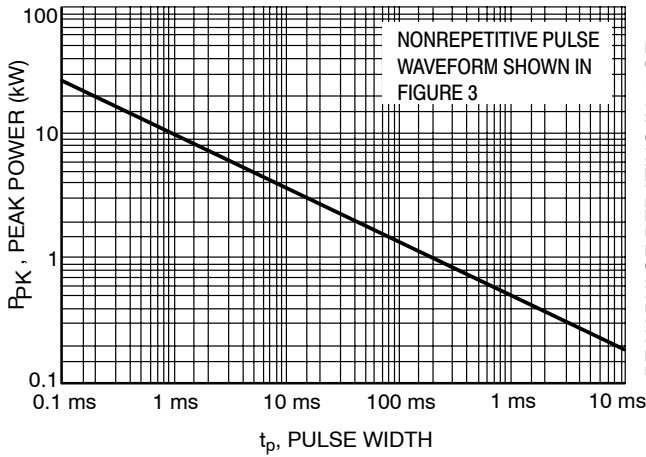

Figure 1. Pulse Rating Curve

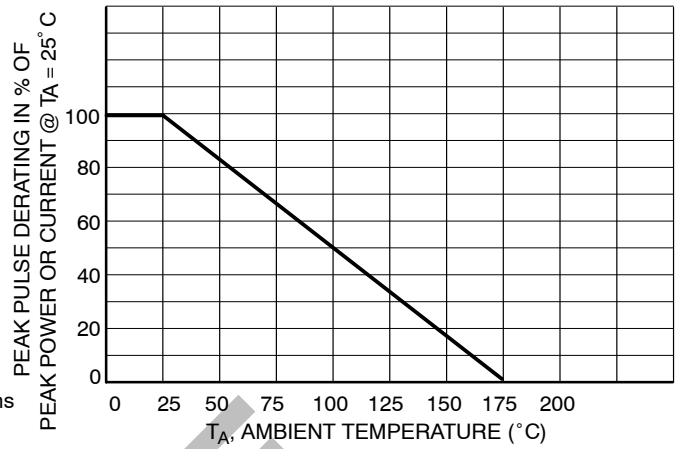

Figure 2. Pulse Derating Curve

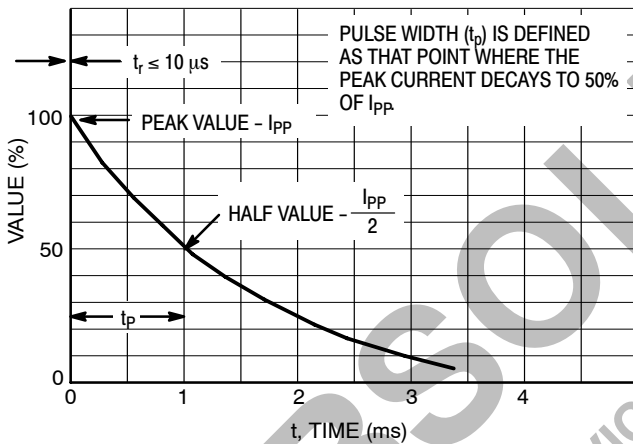

Figure 3. Pulse Waveform

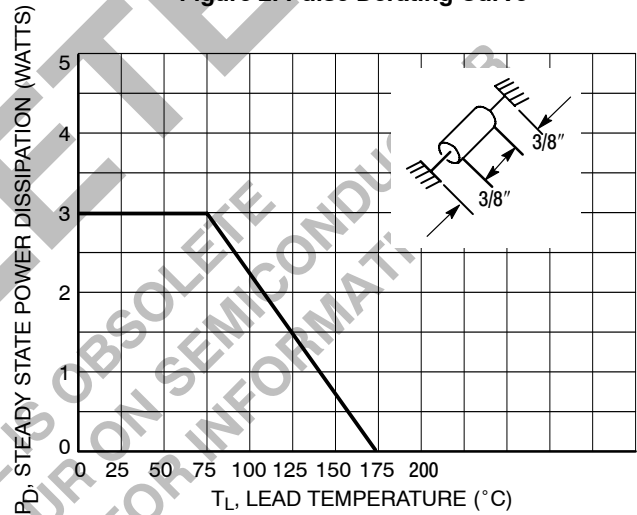

Figure 4. Steady State Power Derating

## UL RECOGNITION\*

The entire series including the bidirectional CA suffix has *Underwriters Laboratory Recognition* for the classification of protectors (QVGV2) under the UL standard for safety 497B and File #E 116110. Many competitors only have one or two devices recognized or have recognition in a non-protective category. Some competitors have no recognition at all. With the UL497B recognition, our parts successfully passed several tests including Strike Voltage

Breakdown test, Endurance Conditioning, Temperature test, Dielectric Voltage-Withstand test, Discharge test and several more.

Whereas, some competitors have only passed a flammability test for the package material, we have been recognized for much more to be included in their protector category.

\*Applies to SA5.0A, CA – SA170A, CA.

# SA5.0CA Series

## OUTLINE DIMENSIONS

# Transient Voltage Suppressors – Axial Leaded

## 500 Watt Peak Power MiniMOSORB™

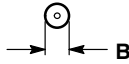

MINI MOSORB  
CASE 59-09  
ISSUE S

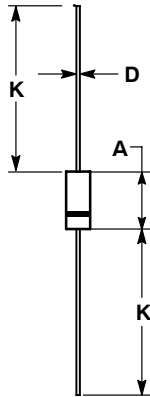

NOTES:

1. DIMENSIONING AND TOLERANCING PER ANSI Y14.5M, 1982.
2. CONTROLLING DIMENSION: INCH.
3. 59-04 OBSOLETE, NEW STANDARD 59-09.
4. 59-03 OBSOLETE, NEW STANDARD 59-10.
5. ALL RULES AND NOTES ASSOCIATED WITH JEDEC DO-41 OUTLINE SHALL APPLY.
6. POLARITY DENOTED BY CATHODE BAND.
7. LEAD DIAMETER NOT CONTROLLED WITHIN F DIMENSION.

DIM	INCHES		MILLIMETERS	
	MIN	MAX	MIN	MAX
A	0.228	0.299	5.80	7.60
B	0.102	0.142	2.60	3.60
D	0.028	0.034	0.71	0.86
K	1.000	---	25.44	---

MiniMOSORB and Surmetic are trademarks of Semiconductor Components Industries, LLC.

**ON Semiconductor** and **ON** are registered trademarks of Semiconductor Components Industries, LLC (SCILLC). SCILLC reserves the right to make changes without further notice to any products herein. SCILLC makes no warranty, representation or guarantee regarding the suitability of its products for any particular purpose, nor does SCILLC assume any liability arising out of the application or use of any product or circuit, and specifically disclaims any and all liability, including without limitation special, consequential or incidental damages. "Typical" parameters which may be provided in SCILLC data sheets and/or specifications can and do vary in different applications and actual performance may vary over time. All operating parameters, including "Typicals" must be validated for each customer application by customer's technical experts. SCILLC does not convey any license under its patent rights nor the rights of others. SCILLC products are not designed, intended, or authorized for use as components in systems intended for surgical implant into the body, or other applications intended to support or sustain life, or for any other application in which the failure of the SCILLC product could create a situation where personal injury or death may occur. Should Buyer purchase or use SCILLC products for any such unintended or unauthorized application, Buyer shall indemnify and hold SCILLC and its officers, employees, subsidiaries, affiliates, and distributors harmless against all claims, costs, damages, and expenses, and reasonable attorney fees arising out of, directly or indirectly, any claim of personal injury or death associated with such unintended or unauthorized use, even if such claim alleges that SCILLC was negligent regarding the design or manufacture of the part. SCILLC is an Equal Opportunity/Affirmative Action Employer. This literature is subject to all applicable copyright laws and is not for resale in any manner.

### PUBLICATION ORDERING INFORMATION

**LITERATURE FULFILLMENT:**  
Literature Distribution Center for ON Semiconductor  
P.O. Box 5163, Denver, Colorado 80217 USA  
**Phone:** 303-675-2175 or 800-344-3860 Toll Free USA/Canada  
**Fax:** 303-675-2176 or 800-344-3867 Toll Free USA/Canada  
**Email:** orderlit@onsemi.com

**N. American Technical Support:** 800-282-9855 Toll Free  
USA/Canada  
**Europe, Middle East and Africa Technical Support:**  
Phone: 421 33 790 2910  
**Japan Customer Focus Center**  
Phone: 81-3-5773-3850

**ON Semiconductor Website:** [www.onsemi.com](http://www.onsemi.com)  
**Order Literature:** <http://www.onsemi.com/orderlit>  
For additional information, please contact your local Sales Representative