

# SA639

## Low voltage mixer FM IF system with filter amplifier and data switch

Rev. 4 — 10 July 2014

Product data sheet

### 1. General description

---

The SA639 is a low-voltage high performance monolithic FM IF system with high-speed RSSI incorporating a mixer/oscillator, two wideband limiting intermediate frequency amplifiers, quadrature detector, logarithmic Received Signal Strength Indicator (RSSI), fast RSSI op amps, voltage regulator, wideband data output, post detection filter amplifier and data switch. The SA639 is available in 24-lead TSSOP (Thin Shrink Small Outline Package).

The SA639 was designed for high-bandwidth portable communication applications and functions down to 2.7 V. The RF section is similar to the famous NE605. The data output provides a minimum bandwidth of 1 MHz to demodulate wideband data. The RSSI output is amplified and has access to the feedback pin. This enables the designer to level adjust the outputs or add filtering.

The post-detection amplifier may be used to realize a low-pass filter function. A programmable data switch routes a portion of the data signal to an external integration circuit that generates a data comparator reference voltage.

SA639 incorporates a Power-down mode which powers down the device when pin 8 (POWER\_DOWN\_CTRL) is HIGH. Power down logic levels are CMOS and TTL compatible with high input impedance.

### 2. Features and benefits

---

- $V_{CC} = 2.7\text{ V to }5.5\text{ V}$
- Low power consumption: 8.6 mA (typical) at 3 V
- Wideband data output (1 MHz minimum)
- Fast RSSI rise and fall times
- Mixer input to >500 MHz
- Mixer conversion power gain of 9.2 dB and noise figure of 11 dB at 110 MHz
- XTAL oscillator effective to 150 MHz (L.C. oscillator to 1 GHz local oscillator can be injected)
- 92 dB of IF amplifier/limiter power gain
- 25 MHz limiter small signal bandwidth
- Temperature compensated logarithmic Received Signal Strength Indicator (RSSI) with a dynamic range in excess of 80 dB
- RSSI output internal op amp
- Post detection amplifier for filtering
- Programmable data switch



- Excellent sensitivity: 2.24  $\mu\text{V}$  into 50  $\Omega$  matching network for 10 dB S/N (Signal-to-Noise ratio) with RF at 110 MHz and IF at 9.8 MHz
- ESD hardened
- Power-down mode

### 3. Applications

- DECT (Digital European Cordless Telephone)
- FSK and ASK data receivers

### 4. Ordering information

Table 1. Ordering information

Type number	Topside mark	Package		Version
		Name	Description	
SA639DH/01	SA639DH	TSSOP24	plastic thin shrink small outline package; 24 leads; body width 4.4 mm	SOT355-1

#### 4.1 Ordering options

Table 2. Ordering options

Type number	Orderable part number	Package	Packing method	Minimum order quantity	Temperature
SA639DH/01	SA639DH/01,112	TSSOP24	Standard marking *IC's tube - DSC bulk pack	1575	$T_{\text{amb}} = -40\text{ }^{\circ}\text{C}$ to $+85\text{ }^{\circ}\text{C}$
	SA639DH/01,118	TSSOP24	Reel 13" Q1/T1 *Standard mark SMD	2500	$T_{\text{amb}} = -40\text{ }^{\circ}\text{C}$ to $+85\text{ }^{\circ}\text{C}$

## 5. Block diagram

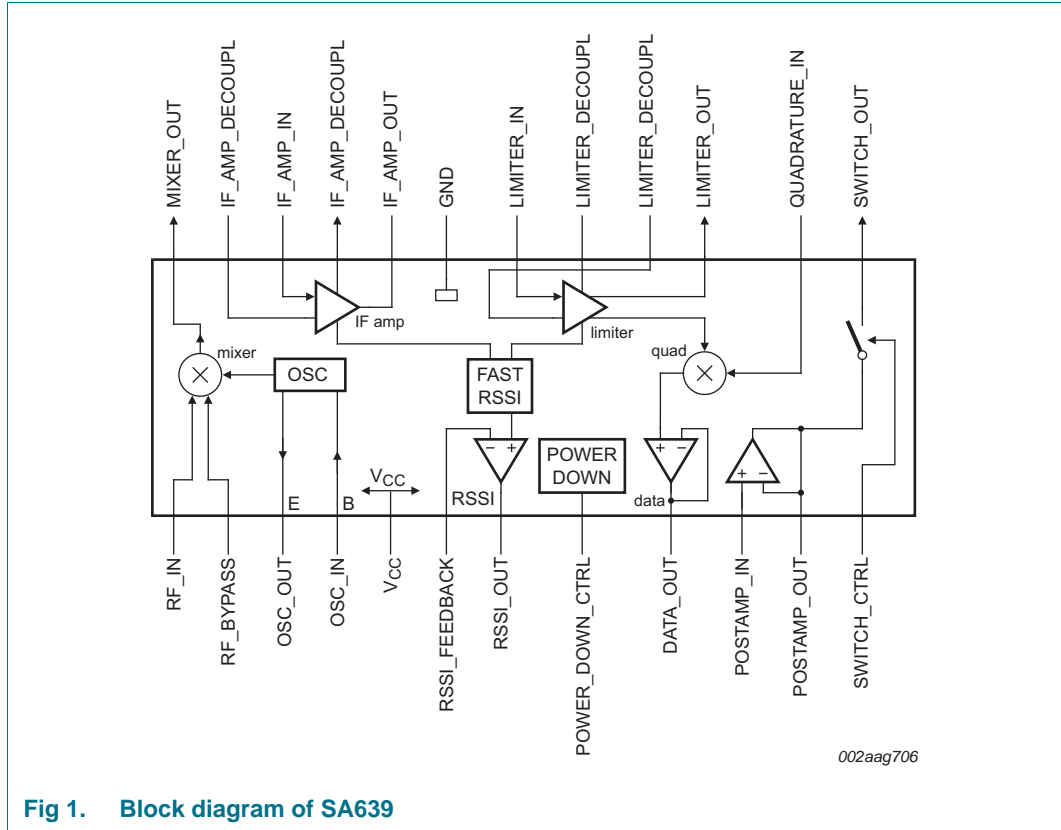

Fig 1. Block diagram of SA639

## 6. Pinning information

### 6.1 Pinning

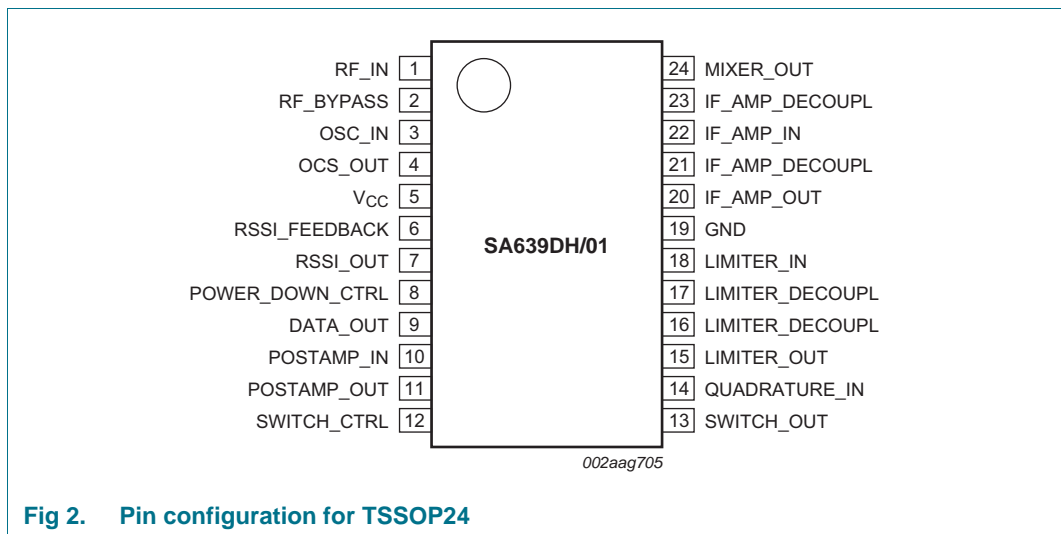

Fig 2. Pin configuration for TSSOP24

## 6.2 Pin description

Table 3. Pin description

Symbol	Pin	Description
RF_IN	1	RF input
RF_BYPASS	2	RF bypass
OSC_OUT	3	oscillator output (emitter)
OSC_IN	4	oscillator input (base)
V <sub>CC</sub>	5	positive supply voltage
RSSI_FEEDBACK	6	RSSI amplifier negative feedback terminal
RSSI_OUT	7	RSSI output
POWER_DOWN_CTRL	8	power-down control; active HIGH
DATA_OUT	9	data output
POSTAMP_IN	10	postamplifier input
POSTAMP_OUT	11	postamplifier output
SWITCH_CTRL	12	switch control
SWITCH_OUT	13	switch output
QUADRATURE_IN	14	quadrature input
LIMITER_OUT	15	limiter output
LIMITER_DECOUPL	16	limiter amplifier decoupling pin
LIMITER_DECOUPL	17	limiter amplifier decoupling pin
LIMITER_IN	18	limiter amplifier input
GND	19	ground; negative supply
IF_AMP_OUT	20	IF amplifier output
IF_AMP_DECOUPL	21	IF amplifier decoupling pin
IF_AMP_IN	22	IF amplifier input
IF_AMP_DECOUPL	23	IF amplifier decoupling pin
MIXER_OUT	24	mixer output

## 7. Functional description

### 7.1 Circuit description

The SA639 is an IF signal processing system suitable for second IF or single conversion systems with input frequency as high as 1 GHz. The bandwidth of the IF amplifier is about 40 MHz, with 44 dB of gain from a 50  $\Omega$  source. The bandwidth of the limiter is about 28 MHz with about 58 dB of gain from a 50  $\Omega$  source. However, the gain/bandwidth distribution is optimized for 9.8 MHz, 330  $\Omega$  source applications. The overall system is well-suited to battery operation as well as high performance and high-quality products of all types, such as digital cordless phones.

The input stage is a Gilbert cell mixer with oscillator. Typical mixer characteristics include a noise figure of 11 dB, conversion power gain of 9.2 dB, and input third-order intercept of  $-9.5$  dBm. The oscillator operates in excess of 1 GHz in L/C tank configurations. Hartley or Colpitts circuits can be used up to 100 MHz for crystal configurations. Butler oscillators are recommended for crystal configurations up to 150 MHz.

The output of the mixer is internally loaded with a 330  $\Omega$  resistor permitting direct connection to a 330  $\Omega$  ceramic filter. The input resistance of the limiting IF amplifiers is also 330  $\Omega$ . With most 330  $\Omega$  ceramic filters and many crystal filters, no impedance matching network is necessary. To achieve optimum linearity of the log signal strength indicator, there must be a 6 dBV insertion loss between the first and second IF stages. If the IF filter or interstage network does not cause 6 dBV insertion loss, a fixed or variable resistor can be added between the first IF output (IF\_AMP\_OUT, pin 20) and the interstage network.

The signal from the second limiting amplifier goes to a Gilbert cell quadrature detector. One port of the Gilbert cell is internally driven by the IF. The other output of the IF is AC-coupled to a tuned quadrature network. This signal, which now has a 90° phase relationship to the internal signal, drives the other port of the multiplier cell.

Overall, the IF section has a gain of 90 dB for operation at intermediate frequency at 9.8 MHz. Special care must be given to layout, termination, and interstage loss to avoid instability.

The demodulated output (DATA\_OUT) of the quadrature is a low-impedance voltage output. This output is designed to handle a minimum bandwidth of 1 MHz. This is designed to demodulate wideband data, such as in DECT applications.

#### 7.1.1 Post detection filter amplifier

The filter amplifier may be used to realize a group delay optimized low-pass filter for post detection. The filter amplifier can be configured for Sallen and Key low-pass with Bessel characteristic and a 3 dB cut frequency of about 800 kHz.

The filter amplifier provides a gain of 0 dB. To reduce frequency response changes as a result of amplifier load variations, the output impedance is less than 500  $\Omega$ . To keep the amplifier frequency response influence on the filter group delay characteristic at a minimum, the filter amplifier has a 3 dB bandwidth of at least 4 MHz. At the center of the carrier, it is mandatory to provide a filter output DC bias voltage of 1.6 V to be within the

input common mode range of the external data comparator. The filter output DC bias voltage specification holds for an exactly center tuned demodulator tank and for the demodulator output connected to the filter amplifier input.

### 7.1.2 Data switch

The SA639 incorporates an active data switch used to derive the data comparator reference voltage with an external integration circuit. The data switch is typically closed for 10  $\mu$ s before and during reception of the synchronization word pattern, and is otherwise open. The external integration circuit is formed by an R/C low-pass with a time constant of 5  $\mu$ s to 10  $\mu$ s.

The active data switch provides excellent tracking behavior over a DC input range of 1.2 V to 2.0 V. For this range with an RC load (no static current drawn), the DC output voltage does not differ more than  $\pm 5$  mV from the input voltage. Since the active data switch is designed to behave like a non-linear charge pump (to allow fast tracking of the input signal without slew rate limitations under dynamic conditions of a 576 kHz input signal with 400 mV peak-to-peak and the RC load), the output signal has a 340 mV peak-to-peak output with a DC average that does not vary from the input DC average by more than  $\pm 10$  mV.

The data switch is able to sink/source 3 mA from/to the external integration circuit to minimize the settling time after long power-down periods (DECT paging mode). In addition, during power-down conditions a reference voltage of approximately 1.6 V is used as the input to the switch. The switch is in a low current mode to maintain the voltage on the external RC load. This will further reduce the settling time of the capacitor after power-up. During power-down the switch can only source and sink a trickle current (10  $\mu$ A). Thus, the user should make sure that other circuits (like the data comparator inputs) are not drawing current from the RC circuit.

The data switch provides a slew rate better than 1 V/ $\mu$ s to track with system DC offset from receive slot to receive slot (DECT idle lock or active mode). When the data switch is opened, the output is in a 3-state mode with a leakage current of less than 100 nA. This reduces discharge of the external integration circuit. When powered-down, the data switch outputs a reference of approximately 1.6 V to maintain a charge on the external RC circuit.

A Received Signal Strength Indicator (RSSI) completes the circuitry. The output range is greater than 80 dB and is temperature compensated. This log signal strength indicator exceeds the criteria for DECT cordless telephone. This signal drives an internal op amp. The op amp is capable of rail-to-rail output. It can be used for gain, filtering, or second-order temperature compensation of the RSSI, if needed.

**Remark:**  $\text{dBV} = 20 \log V_O/V_I$ .

## 8. Internal circuitry

**Table 4. Internal circuits for each pin**

All DC voltages measured with *POWER\_DOWN\_CTRL* (pin 8) = *SWITCH\_CTRL* (pin 12) = *GND* (pin 19) = 0 V; *V<sub>CC</sub>* (pin 5) = 3 V; *DATA\_OUT* (pin 9) connected to *POSTAMP\_IN* (pin 10).

Symbol	Pin	DC V	Equivalent circuit
RF_IN RF_BYPASS	1 2	+1.07 V +1.07 V	<p>002aac983</p>
OSC_OUT OSC_IN	3 4	+1.57 V +2.32 V	<p>002aag707</p>
<i>V<sub>CC</sub></i>	5	+3.00 V	<p>002aac985</p>
RSSI_FEEDBACK	6	+0.20 V	<p>002aac986</p>

**Table 4. Internal circuits for each pin ...continued**

All DC voltages measured with *POWER\_DOWN\_CTRL* (pin 8) = *SWITCH\_CTRL* (pin 12) = *GND* (pin 19) = 0 V; *V<sub>CC</sub>* (pin 5) = 3 V; *DATA\_OUT* (pin 9) connected to *POSTAMP\_IN* (pin 10).

Symbol	Pin	DC V	Equivalent circuit
RSSI_OUT	7	+0.20 V	
POWER_DOWN_CTRL	8	0 V	
DATA_OUT	9	+1.7 V	
POST_AMP_IN	10	+1.70 V	
POST_AMP_OUT	11	+1.70 V	



**Table 4. Internal circuits for each pin ...continued**

All DC voltages measured with *POWER\_DOWN\_CTRL* (pin 8) = *SWITCH\_CTRL* (pin 12) = *GND* (pin 19) = 0 V; *V<sub>CC</sub>* (pin 5) = 3 V; *DATA\_OUT* (pin 9) connected to *POSTAMP\_IN* (pin 10).

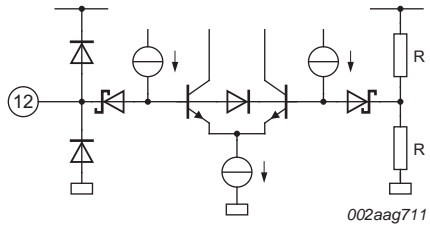
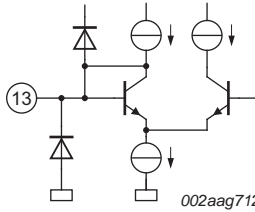
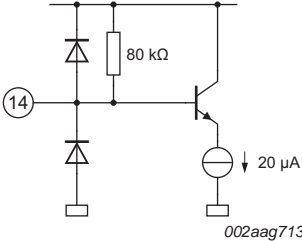
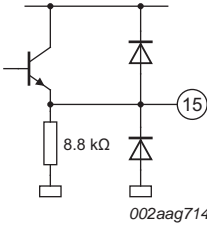
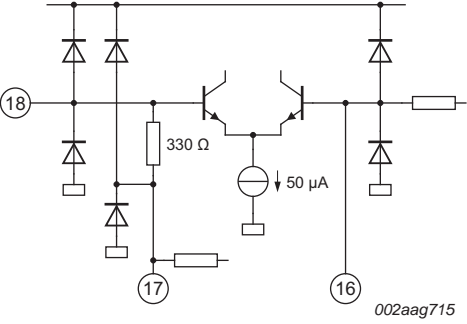
Symbol	Pin	DC V	Equivalent circuit
SWITCH_CTRL	12	0 V	 <p>002aag711</p>
SWITCH_OUT	13	+1.70 V	 <p>002aag712</p>
QUADRATURE_IN	14	+3.00 V	 <p>002aag713</p>
LIMITER_OUT	15	+1.35 V	 <p>002aag714</p>
LIMITER_DECOUPL	16	+1.23 V	 <p>002aag715</p>
LIMITER_DECOUPL	17	+1.23 V	
LIMITER_IN	18	+1.23 V	
GND	19	0 V	-

**Table 4. Internal circuits for each pin ...continued**

All DC voltages measured with *POWER\_DOWN\_CTRL* (pin 8) = *SWITCH\_CTRL* (pin 12) = *GND* (pin 19) = 0 V; *V<sub>CC</sub>* (pin 5) = 3 V; *DATA\_OUT* (pin 9) connected to *POSTAMP\_IN* (pin 10).

Symbol	Pin	DC V	Equivalent circuit
IF_AMP_OUT	20	+1.22 V	<p>002aag716</p>
IF_AMP_DECOUPL	21	+1.22 V	<p>002aag717</p>
IF_AMP_IN	22	+1.22 V	
IF_AMP_DECOUPL	23	+1.22 V	
MIXER_OUT	24	+1.03 V	<p>002aag718</p>

## 9. Limiting values

**Table 5. Limiting values**

*In accordance with the Absolute Maximum Rating System (IEC 60134).*

Symbol	Parameter	Conditions	Min	Max	Unit
$V_{CC}$	supply voltage		-0.3	+6	V
$V_n$	voltage on any other pin	[1]	-0.3	$V_{CC} + 0.3$	V
$T_{stg}$	storage temperature		-65	+150	°C
$T_{amb}$	ambient temperature	operating	-40	+85	°C

[1] Except logic input pins (POWER\_DOWN\_CTRL and SWITCH\_CTRL), which can have 6 V maximum.

## 10. Thermal characteristics

**Table 6. Thermal characteristics**

Symbol	Parameter	Conditions	Typ	Unit
$Z_{th(j-a)}$	transient thermal impedance from junction to ambient	TSSOP24 package	117	°C/W

## 11. Static characteristics

**Table 7. Static characteristics**

$V_{CC} = 3\text{ V}$ ;  $T_{amb} = 25\text{ }^{\circ}\text{C}$ ; unless otherwise specified.

Symbol	Parameter	Conditions	Min	Typ	Max	Unit
$V_{CC}$	supply voltage		2.7	3.0	5.5	V
$I_{CC}$	supply current	DC current drain; POWER_DOWN_CTRL = LOW; SWITCH_CTRL = HIGH; $-3\sigma = 8.33\text{ mA}$ ; $+3\sigma = 8.87\text{ mA}$	-	8.6	10	mA
$I_{CC(stb)}$	standby supply current	POWER_DOWN_CTRL = LOW; SWITCH_CTRL = HIGH $-3\sigma = 131.9\text{ }\mu\text{A}$ ; $+3\sigma = 148.1\text{ }\mu\text{A}$	-	140	500	$\mu\text{A}$
$I_I$	input current	POWER_DOWN_CTRL = LOW	-	-	10	$\mu\text{A}$
		POWER_DOWN_CTRL = HIGH	-	-	4	$\mu\text{A}$
$V_I$	input voltage	POWER_DOWN_CTRL = LOW	0	-	$0.3 \times V_{CC}$	V
		POWER_DOWN_CTRL = HIGH <a href="#">[1]</a>	$0.7 \times V_{CC}$	-	6	V
$t_{ON}$	power-up time	RSSI valid (10 % to 90 %)	-	10	-	$\mu\text{s}$
$t_{OFF}$	power-down time	RSSI invalid (90 % to 10 %)	-	5	-	$\mu\text{s}$
	power-up settling time	data output valid	-	100	200	$\mu\text{s}$
<b>Switching</b>						
$V_I$	input voltage	switch closed; SWITCH_CTRL = LOW; POWER_DOWN_CTRL = LOW	0	-	$0.3 \times V_{CC}$	V
		switch open; output 3-state; SWITCH_CTRL = HIGH	$0.7 \times V_{CC}$	-	6	V
$I_I$	input current	SWITCH_CTRL = LOW	-	-	10	$\mu\text{A}$
		SWITCH_CTRL = HIGH	-	-	4	$\mu\text{A}$
	switch activation time		-	0.5	1	$\mu\text{s}$

[1] When the device is forced in Power-down mode via POWER\_DOWN\_CTRL (pin 8), the data switch outputs a voltage close to 1.6 V and the state of the SWITCH\_CTRL (pin 12) input has no effect.

## 12. Dynamic characteristics

**Table 8. Dynamic characteristics**

$T_{amb} = 25\text{ }^{\circ}\text{C}$ ;  $V_{CC} = +3\text{ V}$ , unless otherwise stated. RF frequency = 110.592 MHz; LO frequency = 120.392 MHz; IF frequency = 9.8 MHz; RF level = -45 dBm; FM modulation = 576 kHz with  $\pm 288\text{ kHz}$  peak deviation, discriminator tank circuit  $Q = 4$ . The parameters listed below are tested using automatic test equipment to assure consistent electrical characteristics. The limits do not represent the ultimate performance limits of the device. Use of an optimized RF layout improves many of the listed parameters.

Symbol	Parameter	Conditions	Min	Typ	Max	Unit
<b>Mixer/oscillator section (external LO = -14 dBm)</b>						
$f_i$	input frequency	signal	-	500	-	MHz
$f_{osc}$	oscillator frequency	external oscillator (buffer)	0.2	500	-	MHz
NF	noise figure	at 110 MHz	-	11	-	dB
IP3 <sub>i</sub>	input third-order intercept point	matched $f_1 = 110.592\text{ MHz}$ ; $f_2 = 110.852\text{ MHz}$	-	-9.5	-	dBm
$G_{p(conv)}$	conversion power gain		6	9.2	-	dB
$R_{i(RF)}$	RF input resistance	single-ended input	-	800	-	$\Omega$
$C_{i(RF)}$	RF input capacitance		-	3.5	-	pF
$R_{o(mix)}$	mixer output resistance	MIXER_OUT pin	-	330	-	$\Omega$
<b>IF section</b>						
$G_{amp(IF)}$	IF amplifier gain		-	40	-	dB
$G_{lim}$	limiter gain		-	52	-	dB
$P_{i(IF)}$	IF input power	for -3 dB input limiting sensitivity; test at IF_AMP_IN pin	-	-100	-	dBm
$Z_{i(IF)}$	IF input impedance		-	330	-	$\Omega$
$Z_{o(IF)}$	IF output impedance		-	330	-	$\Omega$
$Z_{i(lim)}$	limiter input impedance		-	330	-	$\Omega$
$Z_{o(lim)}$	limiter output impedance		-	330	-	$\Omega$
$V_{o(RMS)}$	RMS output voltage	no load; LIMITER_OUT pin	-	130	-	mV
<b>RF/IF section (external LO = -14 dBm)</b>						
	peak-to-peak data level	$R_L = 10\text{ k}\Omega$ ; $C_L = 30\text{ pF}$	260	360	-	mV
	data bandwidth		-	2.4	-	MHz
S/N	signal-to-noise ratio	no modulation for noise	-	60	-	dB
$\alpha_{AM}$	AM rejection	80 % AM 1 kHz	-	36	-	dB
$V_{o(RSSI)}$	RSSI output voltage	RF; with buffer				
		RF level = -90 dBm	0	0.4	0.75	V
		RF level = -45 dBm	0.5	0.9	1.3	V
		RF level = -10 dBm	0.8	1.2	1.6	V
$t_{r(o)}$	output rise time	RF RSSI output; 10 kHz pulse with 9.8 MHz filter; no RSSI bypass capacitor; IF frequency = 9.8 MHz				
		RF level = -45 dBm	-	0.8	-	$\mu\text{s}$
		RF level = -28 dBm	-	0.8	-	$\mu\text{s}$

Low voltage mixer FM IF system with filter amplifier and data switch

**Table 8. Dynamic characteristics ...continued**

$T_{amb} = 25\text{ }^{\circ}\text{C}$ ;  $V_{CC} = +3\text{ V}$ , unless otherwise stated. RF frequency = 110.592 MHz; LO frequency = 120.392 MHz; IF frequency = 9.8 MHz; RF level = -45 dBm; FM modulation = 576 kHz with  $\pm 288\text{ kHz}$  peak deviation, discriminator tank circuit  $Q = 4$ . The parameters listed below are tested using automatic test equipment to assure consistent electrical characteristics. The limits do not represent the ultimate performance limits of the device. Use of an optimized RF layout improves many of the listed parameters.

Symbol	Parameter	Conditions	Min	Typ	Max	Unit	
$t_{f(o)}$	output fall time	RF RSSI output; 10 kHz pulse with 9.8 MHz filter; no RSSI bypass capacitor; IF frequency = 9.8 MHz					
		RF level = -45 dBm	-	2.0	-	$\mu\text{s}$	
		RF level = -28 dBm	-	1.8	-	$\mu\text{s}$	
$\alpha_{RSSI(\text{range})}$	RSSI range		-	80	-	dB	
$\Delta\alpha_{RSSI}$	RSSI variation		-	$\pm 1.5$	-	dB	
SINAD	signal-to-noise-and-distortion ratio	RF level = -85 dBm	-	12	-	dB	
S/N	signal-to-noise ratio	RF level = -100 dBm	-	10	-	dB	
<b>Post detection filter amplifier</b>							
$B_{3dB}$	3 dB bandwidth	amplifier; AC coupled; $R_L = 10\text{ k}\Omega$ ; $C_L = 33\text{ pF}$	-	12.8	-	MHz	
G	gain	amplifier; AC coupled; $R_L = 10\text{ k}\Omega$ ; $V_O(\text{DC}) = 1.6\text{ V}$	-	-0.2	-	dB	
	slew rate	AC coupled; $R_L = 10\text{ k}\Omega$ ; $C_L = 33\text{ pF}$	-	2.4	-	$\text{V}/\mu\text{s}$	
$R_i$	input resistance		300	-	-	$\text{k}\Omega$	
$C_i$	input capacitance		-	-	3	pF	
$Z_o$	output impedance		-	150	800	$\Omega$	
$R_{L(o)}$	output load resistance	AC coupled	5	-	-	$\text{k}\Omega$	
$C_{o(L)}$	output load capacitance	AC coupled	[1]	30	-	pF	
	DC output level		[2]	1.5	1.7	1.9	V
<b>Data switch</b>							
	DC input voltage range		[3]	1.2	1.6	2.0	V
	peak-to-peak AC input swing		-	400	-	mV	
$Z_i$	input impedance		100	-	-	$\text{k}\Omega$	
$C_i$	input capacitance		-	-	5	pF	
$R_{L(o)}$	output load resistance		-	500	-	$\Omega$	
<b>Through mode (SWITCH_CTRL = LOW)</b>							
$G_v$	voltage gain	AC voltage	[4]	-	-1.5	-	dB
	output drive capability	sink/source; $V_O(\text{DC}) = 1.6\text{ V}$	3	-	-	mA	
	slew rate	$V_O(\text{DC}) = 1.6\text{ V}$	-	>14.0	-	$\text{V}/\mu\text{s}$	
	static offset voltage	$V_I(\text{DC}) = 1.2\text{ V to } 2.0\text{ V}$	[5]	0.30	$\pm 5$	mV	
$V_{\text{offset}(\text{DC})}$	DC offset voltage	$V_I(\text{DC}) = 1.4\text{ V to } 2.0\text{ V}$ ; $V_{CC} = 3.0\text{ V to } 5.0\text{ V}$	[2][6]				
		RF level = -70 dBm to -40 dBm	-7	-	+7	mV	
		RF level = -40 dBm to -5 dBm	-10	-	+10	mV	

**Table 8. Dynamic characteristics ...continued**

$T_{amb} = 25\text{ }^{\circ}\text{C}$ ;  $V_{CC} = +3\text{ V}$ , unless otherwise stated. RF frequency = 110.592 MHz; LO frequency = 120.392 MHz; IF frequency = 9.8 MHz; RF level = -45 dBm; FM modulation = 576 kHz with  $\pm 288\text{ kHz}$  peak deviation, discriminator tank circuit  $Q = 4$ . The parameters listed below are tested using automatic test equipment to assure consistent electrical characteristics. The limits do not represent the ultimate performance limits of the device. Use of an optimized RF layout improves many of the listed parameters.

Symbol	Parameter	Conditions	Min	Typ	Max	Unit
<b>3-state mode (SWITCH_CTRL = HIGH)</b>						
$I_{LO}$	output leakage current	$V_O$ (DC) = 1.2 V to 2.0 V	-	20	100	nA

- [1] Includes filter feedback capacitance, comparator input capacitance. PCB stray capacitances and switch input capacitance.
- [2] Demodulator output DC coupled with Post Detection Filter Amplifier input and the demodulator tank exactly tuned to center frequency.
- [3] Includes DC offsets due to frequency offsets between Rx and Tx carrier and demodulator tank offset due to mis-tuning.
- [4] With a 400 mV (peak-to-peak) sinusoid at 600 kHz driving POSTAMP\_IN pin. Output load resistance 500  $\Omega$  in series with 10 nF.
- [5] With a DC input and capacitor in the RC load fully charged.
- [6] The switch is closed every 10 ms for a duration of 40  $\mu\text{s}$ . The DC offset is determined by calculating the difference of two DC measurements, which are determined as follows:
  - a) The first DC value is measured at the integrating capacitor of the switch when the switch is in the closed position immediately before it opens. The value to be measured is in the middle of the peak-to-peak excursion of the superimposed sine-wave. ( $DC_{low} + (DC_{high} - DC_{low}) / 2$ ).
  - b) The second DC value (calculated as above) is measured at POSTAMP\_OUT pin immediately after the switch opens, and is the DC value that gives the largest DC offset to the first DC measurement within a 400  $\mu\text{s}$  DECT burst. Minimum and maximum limits are not tested, however, they are guaranteed by design and characterization using an optimized layout and application circuit.

### 13. Performance curves

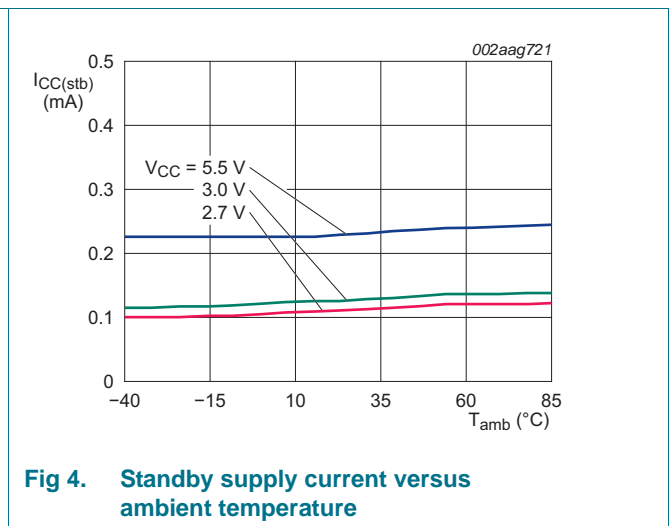
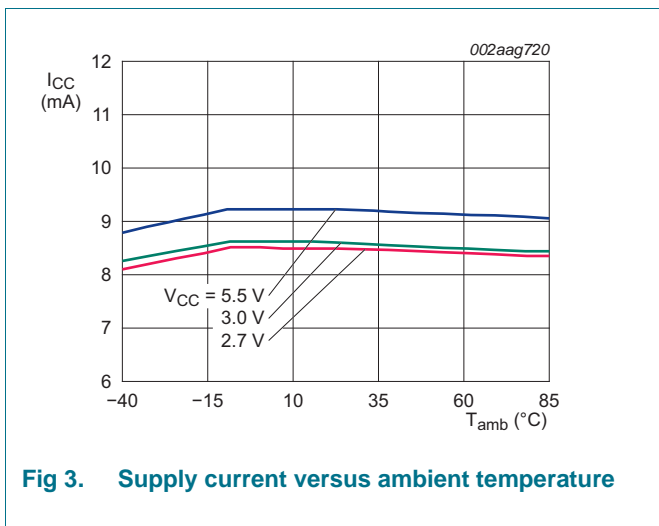

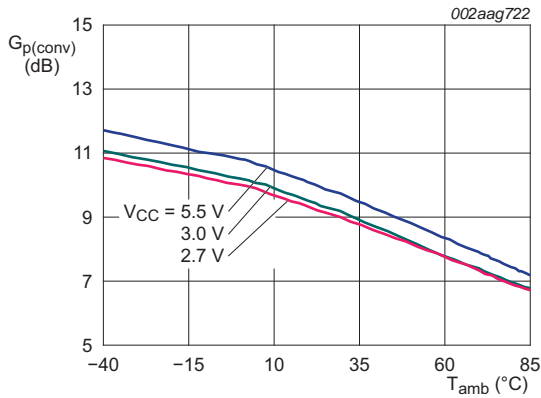

RF = -40 dBm, 110.592 MHz  
LO = -10 dBm, 120.392 MHz

**Fig 5. Mixer conversion power gain versus ambient temperature**

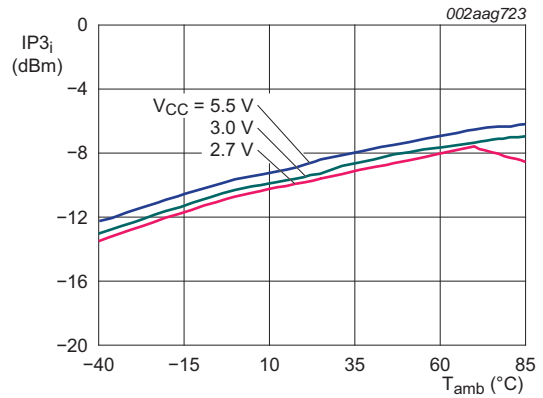

RF = -40 dBm, 110.592 MHz  
LO = -10 dBm, 120.392 MHz

**Fig 6. Mixer input third-order intercept point versus ambient temperature**

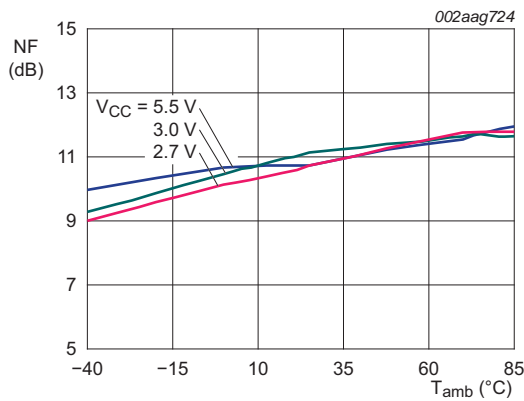

IF = 11 MHz

**Fig 7. Mixer noise figure versus ambient temperature**

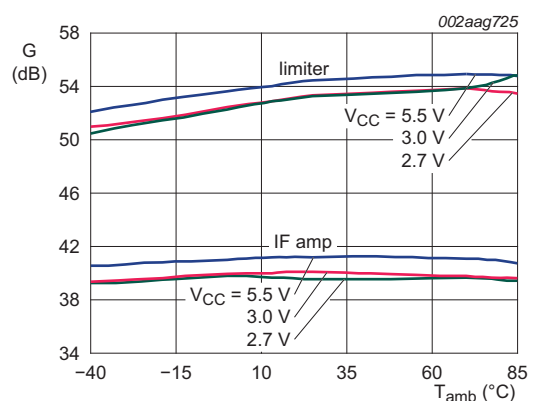

IF input = -90 dBm, 9.8 MHz  
Limiter input = -100 dBm, 9.8 MHz

**Fig 8. Limiter and IF gain versus ambient temperature**



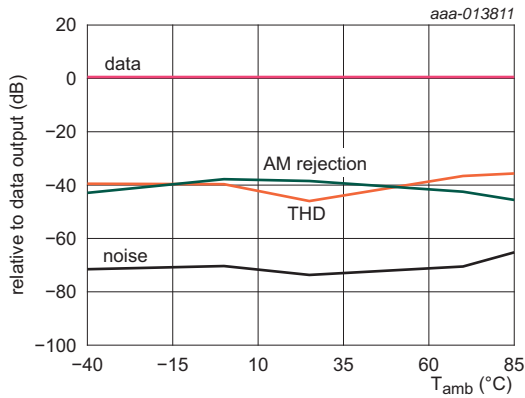

RF = 110 MHz; level = -50 dBm; deviation = 288 kHz;  
LO = 119.8 MHz; -14 dBm; V<sub>CC</sub> = 3 V

**Fig 9. Relative data output level, THD, noise and AM rejection versus ambient temperature**

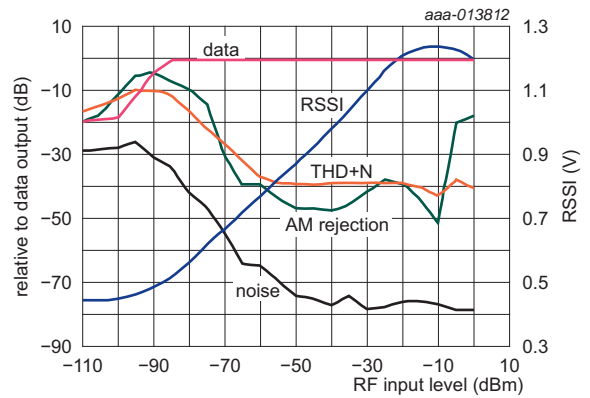

RF = 110 MHz; LO = 119.8 MHz; data = 430.76 mV (peak-to-peak); V<sub>CC</sub> = 3 V; T<sub>amb</sub> = 25 °C; 576 kHz sine

**Fig 10. Receiver RF performance**

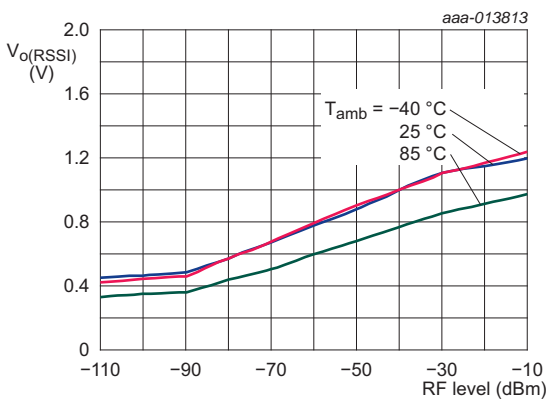

V<sub>CC</sub> = 3 V

**Fig 11. RSSI versus RF level and temperature**

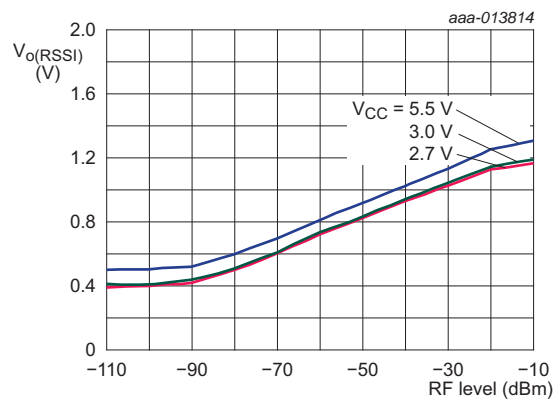

T<sub>amb</sub> = 25 °C

**Fig 12. RSSI versus RF level and V<sub>CC</sub>**

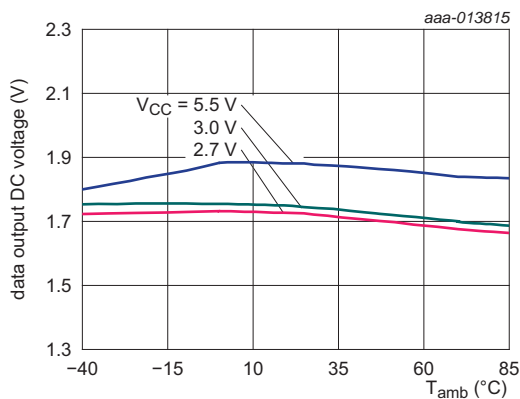

**Fig 13. Data output DC voltage versus ambient temperature**

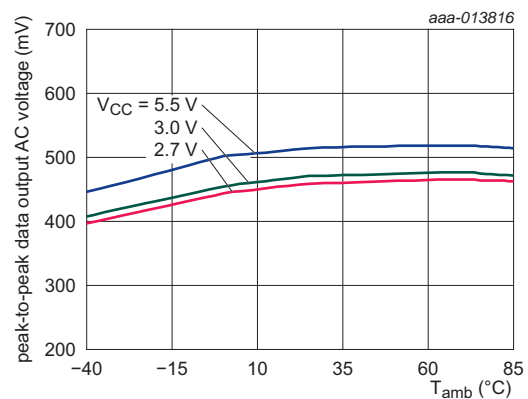

**Fig 14. Data output AC voltage versus ambient temperature**

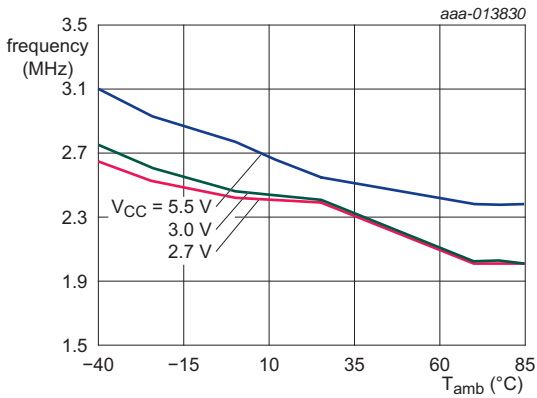

Fig 15. Data output -3 dB bandwidth versus ambient temperature

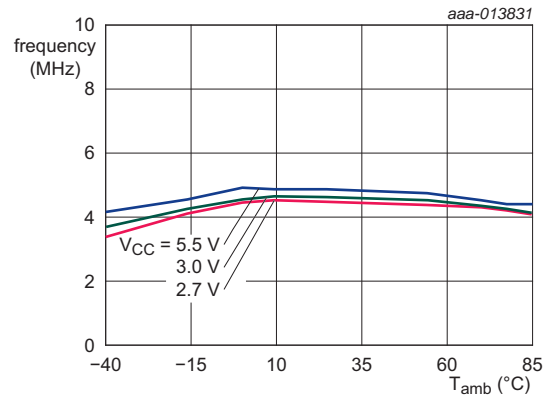

Fig 16. Switch -3 dB bandwidth versus ambient temperature

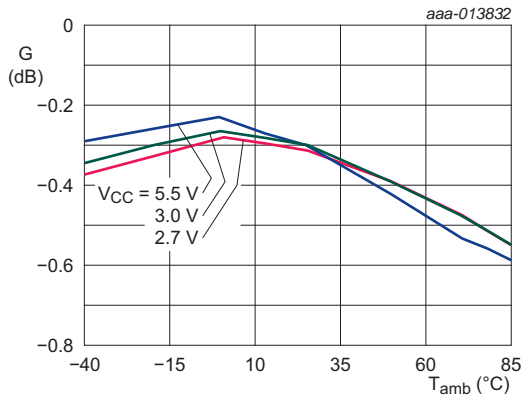

Fig 17. Post detection amplifier versus ambient temperature

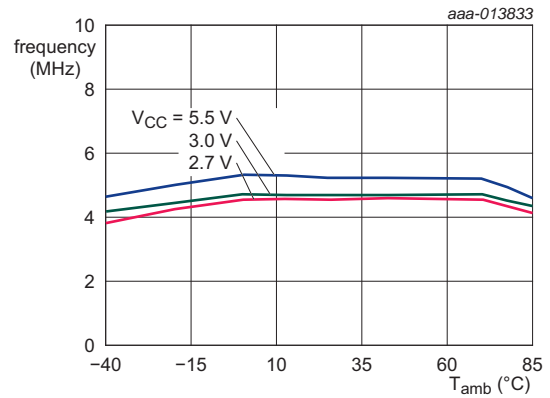

Fig 18. Post detection amplifier -3 dB bandwidth versus ambient temperature

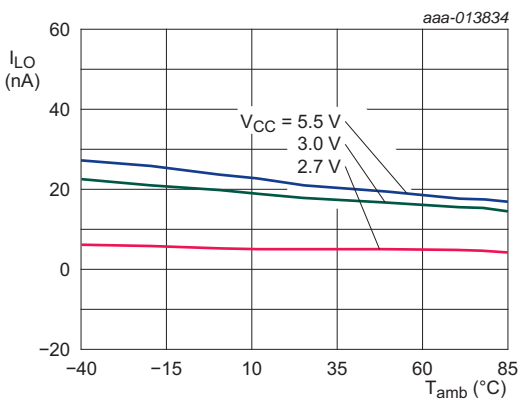

Fig 19. Switch output leakage current versus ambient temperature

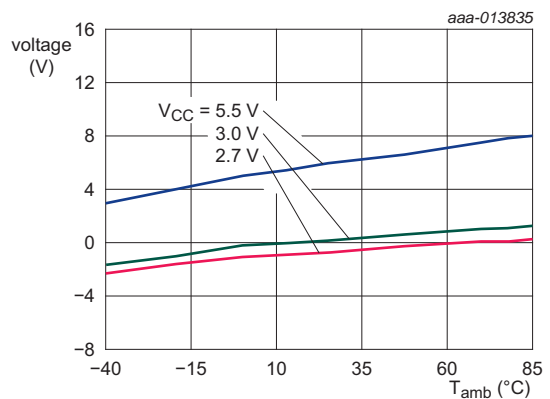

Fig 20. Switch output to input offset voltage versus ambient temperature

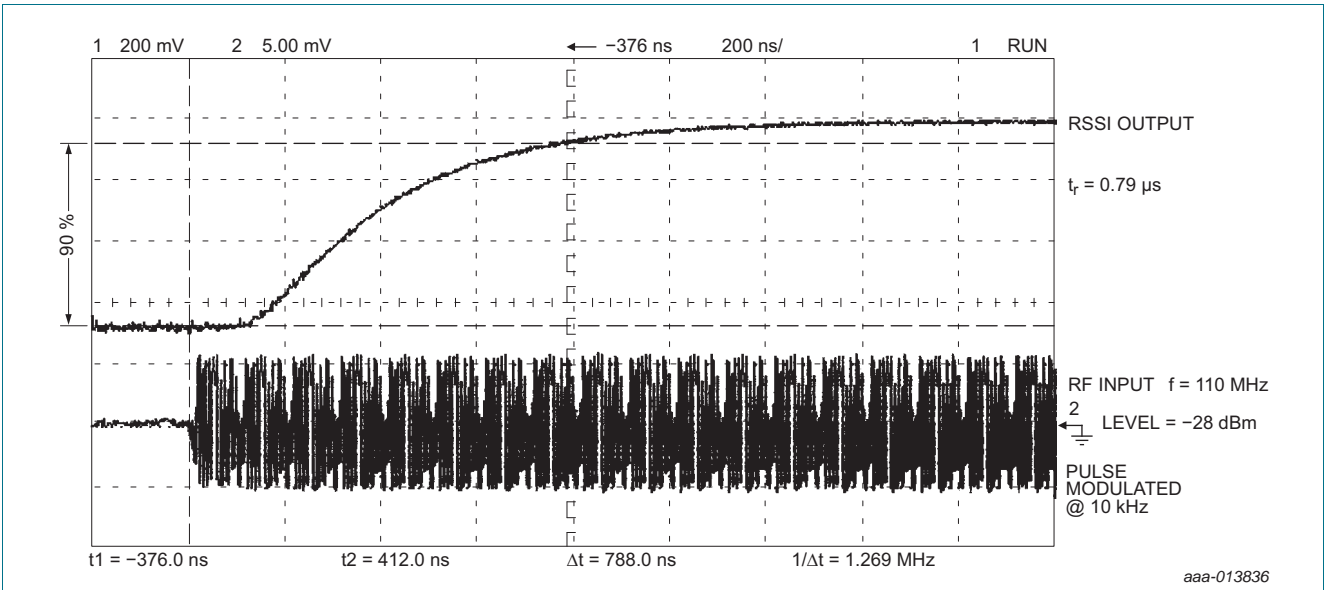

Fig 21. RSSI rise time

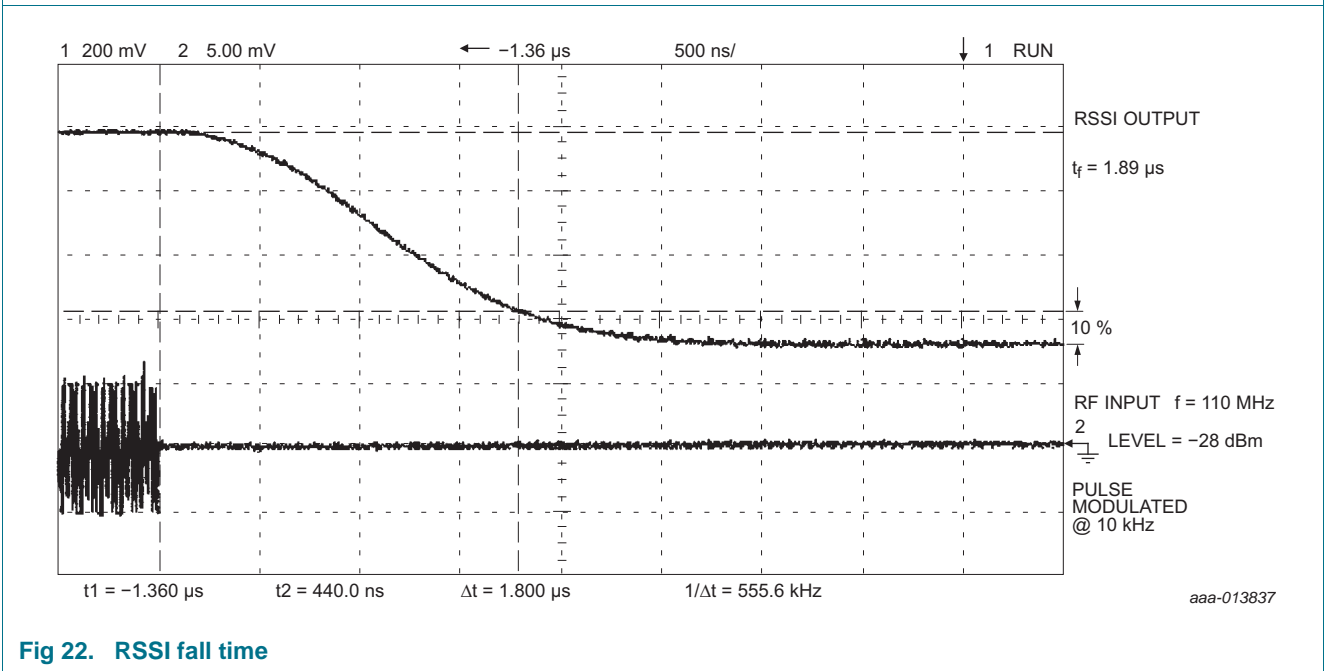

Fig 22. RSSI fall time

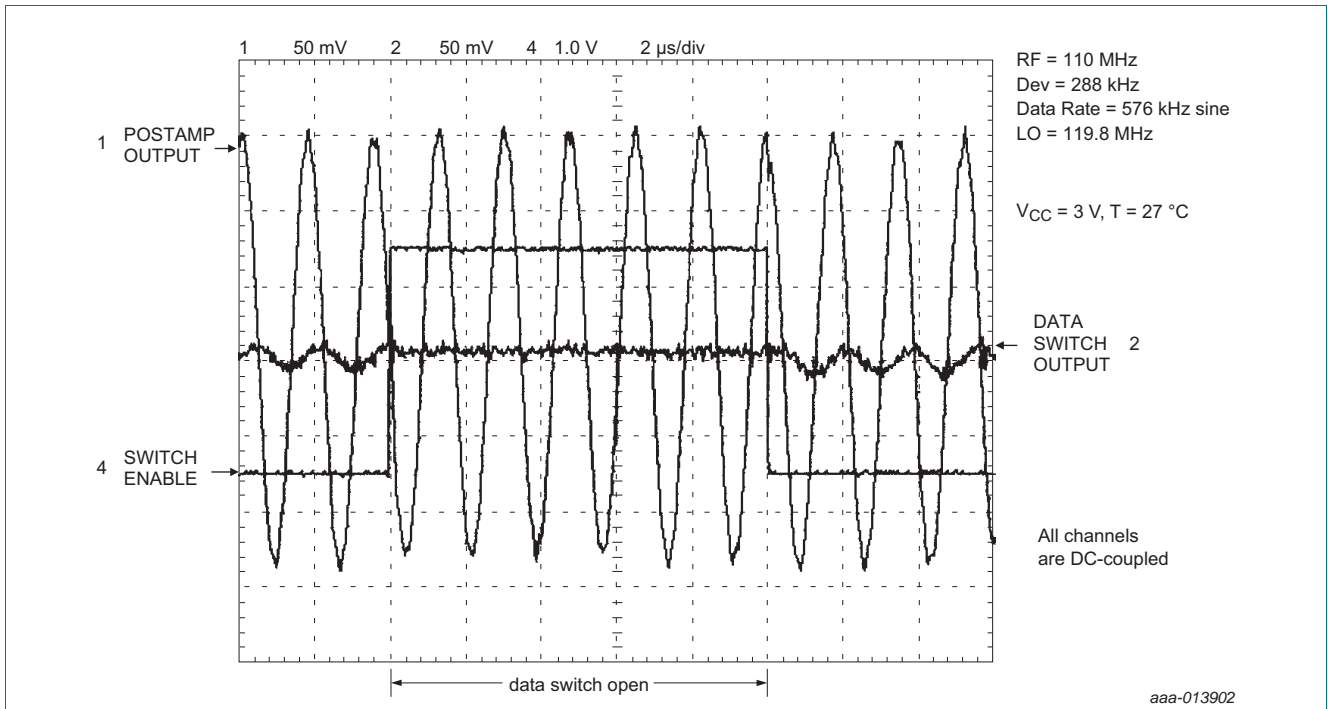

Fig 23. System dynamic response

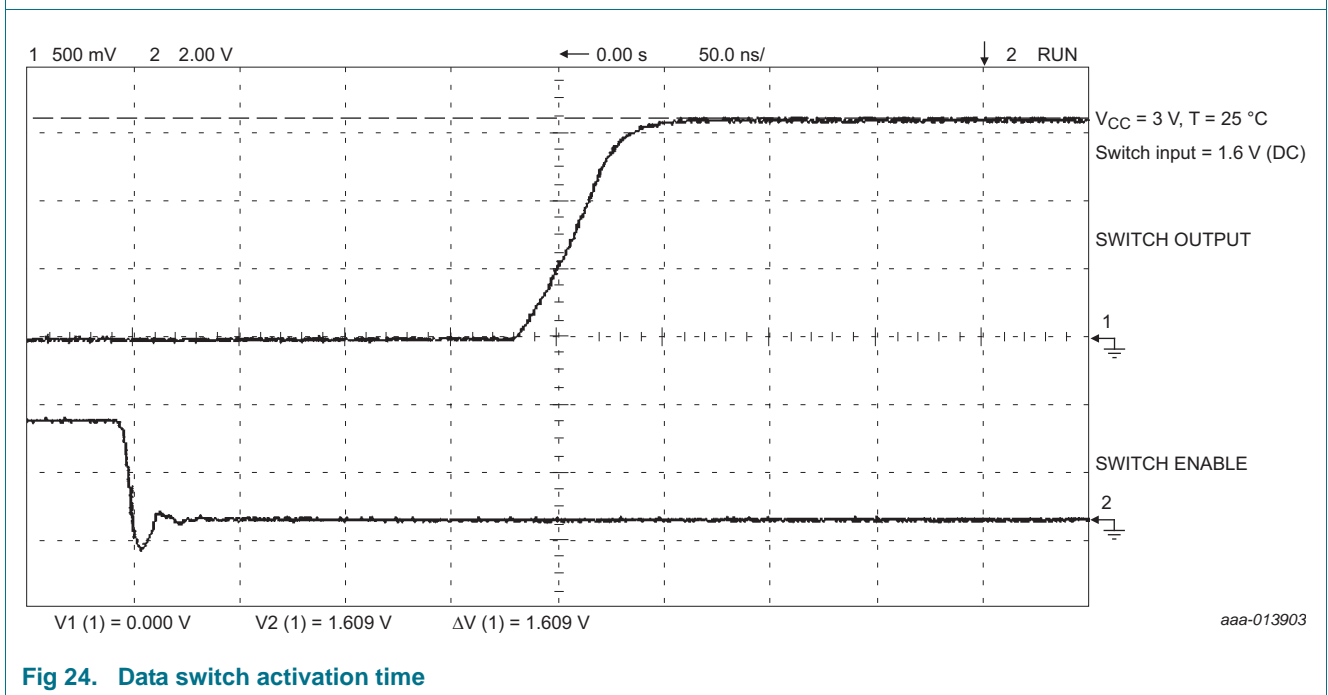

Fig 24. Data switch activation time

14. Test information

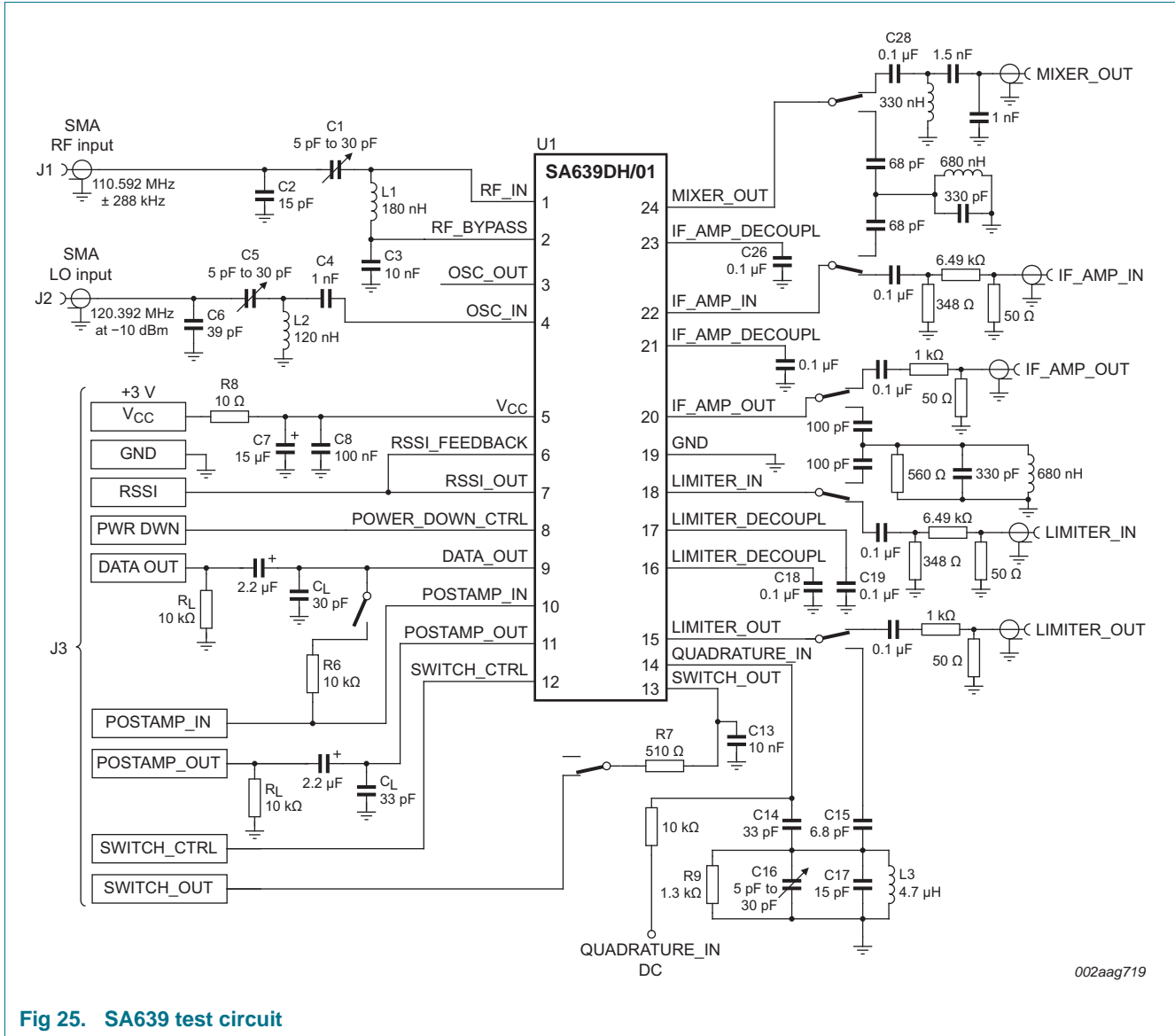

Fig 25. SA639 test circuit

15. Package outline

TSSOP24: plastic thin shrink small outline package; 24 leads; body width 4.4 mm

SOT355-1

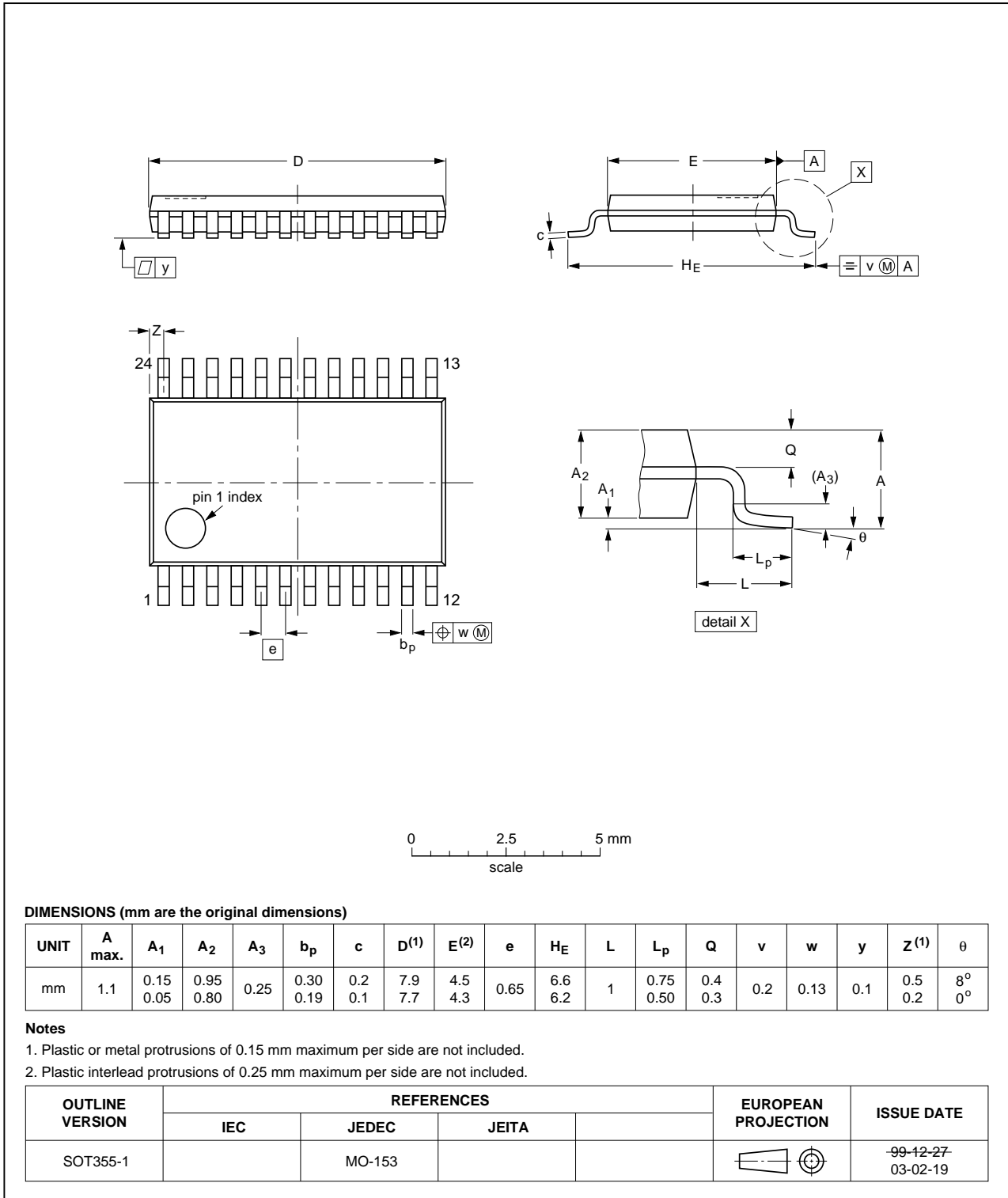

Fig 26. Package outline SOT355-1 (TSSOP24)

## 16. Soldering of SMD packages

This text provides a very brief insight into a complex technology. A more in-depth account of soldering ICs can be found in Application Note *AN10365 "Surface mount reflow soldering description"*.

### 16.1 Introduction to soldering

Soldering is one of the most common methods through which packages are attached to Printed Circuit Boards (PCBs), to form electrical circuits. The soldered joint provides both the mechanical and the electrical connection. There is no single soldering method that is ideal for all IC packages. Wave soldering is often preferred when through-hole and Surface Mount Devices (SMDs) are mixed on one printed wiring board; however, it is not suitable for fine pitch SMDs. Reflow soldering is ideal for the small pitches and high densities that come with increased miniaturization.

### 16.2 Wave and reflow soldering

Wave soldering is a joining technology in which the joints are made by solder coming from a standing wave of liquid solder. The wave soldering process is suitable for the following:

- Through-hole components
- Leaded or leadless SMDs, which are glued to the surface of the printed circuit board

Not all SMDs can be wave soldered. Packages with solder balls, and some leadless packages which have solder lands underneath the body, cannot be wave soldered. Also, leaded SMDs with leads having a pitch smaller than ~0.6 mm cannot be wave soldered, due to an increased probability of bridging.

The reflow soldering process involves applying solder paste to a board, followed by component placement and exposure to a temperature profile. Leaded packages, packages with solder balls, and leadless packages are all reflow solderable.

Key characteristics in both wave and reflow soldering are:

- Board specifications, including the board finish, solder masks and vias
- Package footprints, including solder thieves and orientation
- The moisture sensitivity level of the packages
- Package placement
- Inspection and repair
- Lead-free soldering versus SnPb soldering

### 16.3 Wave soldering

Key characteristics in wave soldering are:

- Process issues, such as application of adhesive and flux, clinching of leads, board transport, the solder wave parameters, and the time during which components are exposed to the wave
- Solder bath specifications, including temperature and impurities

### 16.4 Reflow soldering

Key characteristics in reflow soldering are:

- Lead-free versus SnPb soldering; note that a lead-free reflow process usually leads to higher minimum peak temperatures (see [Figure 27](#)) than a SnPb process, thus reducing the process window
- Solder paste printing issues including smearing, release, and adjusting the process window for a mix of large and small components on one board
- Reflow temperature profile; this profile includes preheat, reflow (in which the board is heated to the peak temperature) and cooling down. It is imperative that the peak temperature is high enough for the solder to make reliable solder joints (a solder paste characteristic). In addition, the peak temperature must be low enough that the packages and/or boards are not damaged. The peak temperature of the package depends on package thickness and volume and is classified in accordance with [Table 9](#) and [10](#)

**Table 9. SnPb eutectic process (from J-STD-020D)**

Package thickness (mm)	Package reflow temperature (°C)	
	Volume (mm <sup>3</sup> )	
	< 350	≥ 350
< 2.5	235	220
≥ 2.5	220	220

**Table 10. Lead-free process (from J-STD-020D)**

Package thickness (mm)	Package reflow temperature (°C)		
	Volume (mm <sup>3</sup> )		
	< 350	350 to 2000	> 2000
< 1.6	260	260	260
1.6 to 2.5	260	250	245
> 2.5	250	245	245

Moisture sensitivity precautions, as indicated on the packing, must be respected at all times.

Studies have shown that small packages reach higher temperatures during reflow soldering, see [Figure 27](#).



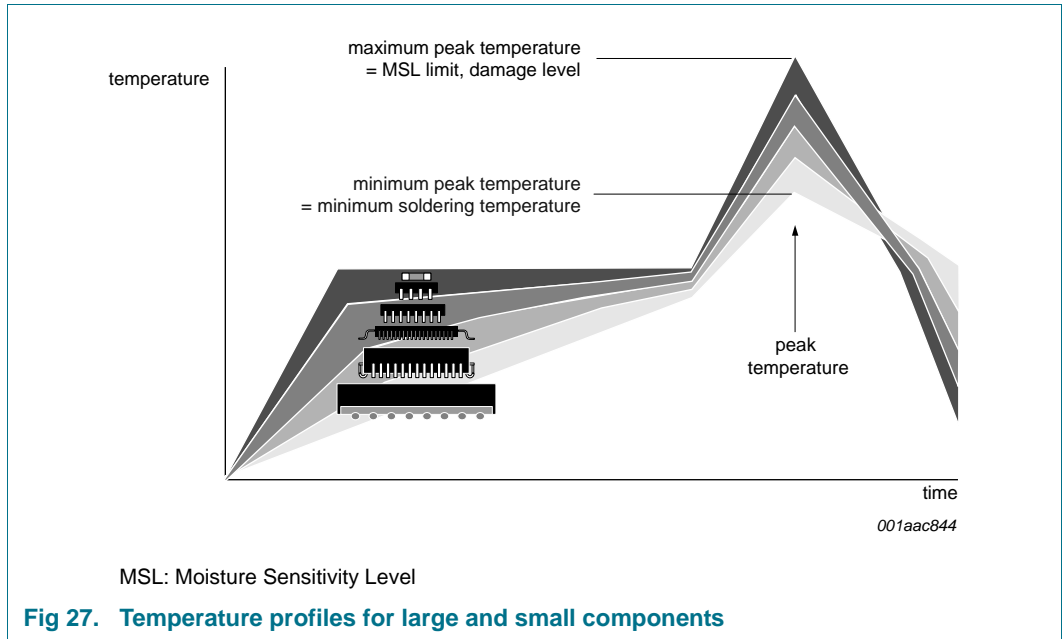

For further information on temperature profiles, refer to Application Note AN10365 “Surface mount reflow soldering description”.

## 17. Abbreviations

Table 11. Abbreviations

Acronym	Description
AM	Amplitude Modulation
ASK	Amplitude Shift Keying
CMOS	Complementary Metal-Oxide Semiconductor
DECT	Digital European Cordless Telephone
ESD	ElectroStatic Discharge
FM	Frequency Modulation
FSK	Frequency Shift Keying
IF	Intermediate Frequency
LC	inductor-capacitor network
LO	Local Oscillator
PCB	Printed-Circuit Board
RC	resistor-capacitor network
RF	Radio Frequency
RSSI	Received Signal Strength Indicator
THD	Total Harmonic Distortion
TTL	Transistor-Transistor Logic

## 18. Revision history

Table 12. Revision history

Document ID	Release date	Data sheet status	Change notice	Supersedes
SA639 v.4	20140710	Product data sheet	-	SA639 v.3
Modifications:	<ul style="list-style-type: none"> <li>• The format of this data sheet has been redesigned to comply with the new identity guidelines of NXP Semiconductors.</li> <li>• Legal texts have been adapted to the new company name where appropriate.</li> <li>• <a href="#">Table 1 “Ordering information”</a>: Type number SA639DH is replaced with SA639DH/01</li> <li>• Added <a href="#">Section 4.1 “Ordering options”</a></li> <li>• Added <a href="#">Section 6.2 “Pin description”</a> <ul style="list-style-type: none"> <li>– Pin 3 name changed from “XTAL OSC (EMITTER)” to “OSC_OUT”</li> <li>– Pin 4 name changed from “XTAL OSC (BASE)” to “OSC_IN”</li> </ul> </li> <li>• Added <a href="#">Table 6 “Thermal characteristics”</a></li> <li>• <a href="#">Table 7 “Static characteristics”</a>:                             <ul style="list-style-type: none"> <li>– deleted column ‘<math>-3\sigma</math>’</li> <li>– deleted column ‘<math>+3\sigma</math>’</li> </ul> </li> <li>• <a href="#">Table 8 “Dynamic characteristics”</a>:                             <ul style="list-style-type: none"> <li>– deleted column ‘<math>-3\sigma</math>’</li> <li>– deleted column ‘<math>+3\sigma</math>’</li> <li>– deleted (old) Table note [7] “Standard deviations are measured based on application of 60 parts.”</li> </ul> </li> <li>• <a href="#">Figure 5 “Mixer conversion power gain versus ambient temperature”</a>:                             <ul style="list-style-type: none"> <li>– Note corrected from “RF = -40 dBm, 110.392 MHz” to “RF = -40 dBm, 110.592 MHz”</li> <li>– Note corrected from “LO = -10 dBm, 120.592 MHz” to “LO = -10 dBm, 120.392 MHz”</li> </ul> </li> <li>• <a href="#">Figure 6 “Mixer input third-order intercept point versus ambient temperature”</a>:                             <ul style="list-style-type: none"> <li>– Note corrected from “RF = -40 dBm, 110.392 MHz” to “RF = -40 dBm, 110.592 MHz”</li> <li>– Note corrected from “LO = -10 dBm, 120.592 MHz” to “LO = -10 dBm, 120.392 MHz”</li> </ul> </li> <li>• <a href="#">Figure 10 “Receiver RF performance”</a>: note corrected from “RF = 110 kHz” to “RF = 110 MHz”</li> <li>• <a href="#">Figure 25 “SA639 test circuit”</a> updated</li> <li>• Added <a href="#">Section 16 “Soldering of SMD packages”</a></li> <li>• Added <a href="#">Section 17 “Abbreviations”</a></li> </ul>			
SA639 v.3	19980210	Product specification	ECN 853-1792 18944 dated 1998 Feb 10	SA639 v.2
SA639 v.2	19980210	Product specification	ECN 853-1792 18944 dated 1998 Feb 10	SA639 v.1
SA639 v.1	19960531	Product specification	ECN 853-1792 16895 dated 1996 May 31	-

## 19. Legal information

### 19.1 Data sheet status

Document status <sup>[1][2]</sup>	Product status <sup>[3]</sup>	Definition
Objective [short] data sheet	Development	This document contains data from the objective specification for product development.
Preliminary [short] data sheet	Qualification	This document contains data from the preliminary specification.
Product [short] data sheet	Production	This document contains the product specification.

[1] Please consult the most recently issued document before initiating or completing a design.

[2] The term 'short data sheet' is explained in section "Definitions".

[3] The product status of device(s) described in this document may have changed since this document was published and may differ in case of multiple devices. The latest product status information is available on the Internet at URL <http://www.nxp.com>.

### 19.2 Definitions

**Draft** — The document is a draft version only. The content is still under internal review and subject to formal approval, which may result in modifications or additions. NXP Semiconductors does not give any representations or warranties as to the accuracy or completeness of information included herein and shall have no liability for the consequences of use of such information.

**Short data sheet** — A short data sheet is an extract from a full data sheet with the same product type number(s) and title. A short data sheet is intended for quick reference only and should not be relied upon to contain detailed and full information. For detailed and full information see the relevant full data sheet, which is available on request via the local NXP Semiconductors sales office. In case of any inconsistency or conflict with the short data sheet, the full data sheet shall prevail.

**Product specification** — The information and data provided in a Product data sheet shall define the specification of the product as agreed between NXP Semiconductors and its customer, unless NXP Semiconductors and customer have explicitly agreed otherwise in writing. In no event however, shall an agreement be valid in which the NXP Semiconductors product is deemed to offer functions and qualities beyond those described in the Product data sheet.

### 19.3 Disclaimers

**Limited warranty and liability** — Information in this document is believed to be accurate and reliable. However, NXP Semiconductors does not give any representations or warranties, expressed or implied, as to the accuracy or completeness of such information and shall have no liability for the consequences of use of such information. NXP Semiconductors takes no responsibility for the content in this document if provided by an information source outside of NXP Semiconductors.

In no event shall NXP Semiconductors be liable for any indirect, incidental, punitive, special or consequential damages (including - without limitation - lost profits, lost savings, business interruption, costs related to the removal or replacement of any products or rework charges) whether or not such damages are based on tort (including negligence), warranty, breach of contract or any other legal theory.

Notwithstanding any damages that customer might incur for any reason whatsoever, NXP Semiconductors' aggregate and cumulative liability towards customer for the products described herein shall be limited in accordance with the *Terms and conditions of commercial sale* of NXP Semiconductors.

**Right to make changes** — NXP Semiconductors reserves the right to make changes to information published in this document, including without limitation specifications and product descriptions, at any time and without notice. This document supersedes and replaces all information supplied prior to the publication hereof.

**Suitability for use** — NXP Semiconductors products are not designed, authorized or warranted to be suitable for use in life support, life-critical or safety-critical systems or equipment, nor in applications where failure or malfunction of an NXP Semiconductors product can reasonably be expected to result in personal injury, death or severe property or environmental damage. NXP Semiconductors and its suppliers accept no liability for inclusion and/or use of NXP Semiconductors products in such equipment or applications and therefore such inclusion and/or use is at the customer's own risk.

**Applications** — Applications that are described herein for any of these products are for illustrative purposes only. NXP Semiconductors makes no representation or warranty that such applications will be suitable for the specified use without further testing or modification.

Customers are responsible for the design and operation of their applications and products using NXP Semiconductors products, and NXP Semiconductors accepts no liability for any assistance with applications or customer product design. It is customer's sole responsibility to determine whether the NXP Semiconductors product is suitable and fit for the customer's applications and products planned, as well as for the planned application and use of customer's third party customer(s). Customers should provide appropriate design and operating safeguards to minimize the risks associated with their applications and products.

NXP Semiconductors does not accept any liability related to any default, damage, costs or problem which is based on any weakness or default in the customer's applications or products, or the application or use by customer's third party customer(s). Customer is responsible for doing all necessary testing for the customer's applications and products using NXP Semiconductors products in order to avoid a default of the applications and the products or of the application or use by customer's third party customer(s). NXP does not accept any liability in this respect.

**Limiting values** — Stress above one or more limiting values (as defined in the Absolute Maximum Ratings System of IEC 60134) will cause permanent damage to the device. Limiting values are stress ratings only and (proper) operation of the device at these or any other conditions above those given in the Recommended operating conditions section (if present) or the Characteristics sections of this document is not warranted. Constant or repeated exposure to limiting values will permanently and irreversibly affect the quality and reliability of the device.

**Terms and conditions of commercial sale** — NXP Semiconductors products are sold subject to the general terms and conditions of commercial sale, as published at <http://www.nxp.com/profile/terms>, unless otherwise agreed in a valid written individual agreement. In case an individual agreement is concluded only the terms and conditions of the respective agreement shall apply. NXP Semiconductors hereby expressly objects to applying the customer's general terms and conditions with regard to the purchase of NXP Semiconductors products by customer.

**No offer to sell or license** — Nothing in this document may be interpreted or construed as an offer to sell products that is open for acceptance or the grant, conveyance or implication of any license under any copyrights, patents or other industrial or intellectual property rights.

**Export control** — This document as well as the item(s) described herein may be subject to export control regulations. Export might require a prior authorization from competent authorities.

**Non-automotive qualified products** — Unless this data sheet expressly states that this specific NXP Semiconductors product is automotive qualified, the product is not suitable for automotive use. It is neither qualified nor tested in accordance with automotive testing or application requirements. NXP Semiconductors accepts no liability for inclusion and/or use of non-automotive qualified products in automotive equipment or applications.

In the event that customer uses the product for design-in and use in automotive applications to automotive specifications and standards, customer (a) shall use the product without NXP Semiconductors' warranty of the product for such automotive applications, use and specifications, and (b) whenever customer uses the product for automotive applications beyond

NXP Semiconductors' specifications such use shall be solely at customer's own risk, and (c) customer fully indemnifies NXP Semiconductors for any liability, damages or failed product claims resulting from customer design and use of the product for automotive applications beyond NXP Semiconductors' standard warranty and NXP Semiconductors' product specifications.

**Translations** — A non-English (translated) version of a document is for reference only. The English version shall prevail in case of any discrepancy between the translated and English versions.

## 19.4 Trademarks

Notice: All referenced brands, product names, service names and trademarks are the property of their respective owners.

## 20. Contact information

For more information, please visit: <http://www.nxp.com>

For sales office addresses, please send an email to: [salesaddresses@nxp.com](mailto:salesaddresses@nxp.com)

## 21. Contents

<b>1</b>	<b>General description</b> .....	<b>1</b>
<b>2</b>	<b>Features and benefits</b> .....	<b>1</b>
<b>3</b>	<b>Applications</b> .....	<b>2</b>
<b>4</b>	<b>Ordering information</b> .....	<b>2</b>
4.1	Ordering options .....	2
<b>5</b>	<b>Block diagram</b> .....	<b>3</b>
<b>6</b>	<b>Pinning information</b> .....	<b>3</b>
6.1	Pinning .....	3
6.2	Pin description .....	4
<b>7</b>	<b>Functional description</b> .....	<b>5</b>
7.1	Circuit description .....	5
7.1.1	Post detection filter amplifier .....	5
7.1.2	Data switch .....	6
<b>8</b>	<b>Internal circuitry</b> .....	<b>7</b>
<b>9</b>	<b>Limiting values</b> .....	<b>11</b>
<b>10</b>	<b>Thermal characteristics</b> .....	<b>11</b>
<b>11</b>	<b>Static characteristics</b> .....	<b>12</b>
<b>12</b>	<b>Dynamic characteristics</b> .....	<b>13</b>
<b>13</b>	<b>Performance curves</b> .....	<b>15</b>
<b>14</b>	<b>Test information</b> .....	<b>21</b>
<b>15</b>	<b>Package outline</b> .....	<b>22</b>
<b>16</b>	<b>Soldering of SMD packages</b> .....	<b>23</b>
16.1	Introduction to soldering .....	23
16.2	Wave and reflow soldering .....	23
16.3	Wave soldering .....	23
16.4	Reflow soldering .....	24
<b>17</b>	<b>Abbreviations</b> .....	<b>25</b>
<b>18</b>	<b>Revision history</b> .....	<b>26</b>
<b>19</b>	<b>Legal information</b> .....	<b>27</b>
19.1	Data sheet status .....	27
19.2	Definitions .....	27
19.3	Disclaimers .....	27
19.4	Trademarks .....	28
<b>20</b>	<b>Contact information</b> .....	<b>28</b>
<b>21</b>	<b>Contents</b> .....	<b>29</b>

Please be aware that important notices concerning this document and the product(s) described herein, have been included in section 'Legal information'.

© NXP Semiconductors N.V. 2014.

All rights reserved.

For more information, please visit: <http://www.nxp.com>

For sales office addresses, please send an email to: [salesaddresses@nxp.com](mailto:salesaddresses@nxp.com)

Date of release: 10 July 2014

Document identifier: SA639