

# DATA SHEET



## **SAB9079HS** Multistandard Picture-In-Picture (PIP) controller

Preliminary specification  
File under Integrated Circuits, IC02

2000 Jan 13

# Multistandard Picture-In-Picture (PIP) controller

## SAB9079HS

### FEATURES

- Suitable for single PIP, double window and multi PIP applications
- Data formats 4 : 1 : 1 (all modes) and 4 : 2 : 2 (most modes)
- Sample rate of 14 MHz, 720 Y\*-pixels/line
- Horizontal reduction factors  $\frac{1}{4}$ ,  $\frac{3}{4}$ ,  $\frac{2}{3}$ ,  $\frac{1}{2}$ ,  $\frac{1}{3}$ ,  $\frac{1}{4}$  and  $\frac{1}{6}$
- Vertical reduction factors  $\frac{1}{4}$ ,  $\frac{1}{2}$ ,  $\frac{1}{3}$  and  $\frac{1}{4}$
- PIP OSD for the sub channels displayed
- Detection of PAL/NTSC with overrule bit
- CTE/LTE like circuits in display part
- Replay with definable auto increment, picture sample rate and picture number auto wrap
- Programmable Y\*UV to RGB conversion matrix with independent coefficients for NTSC and PAL sources
- Display clock and synchronisation are derived from the main PLL
- Three 8-bit Digital-to-Analog Converters (DACs)
- Three 8-bit Analog-to-Digital Converters (ADCs) (7-bit performance) with clamp circuit for each acquisition channel
- Main and sub can write to the same VDRAM address spaces under certain conditions; the reduction factors should be the same
- Y\* and UV pedestals on the acquisition sides
- Independent vertical filtering with 1 : 1 for UV and Y\* at the display part.



### GENERAL DESCRIPTION

The SAB9079HS is a PIP controller for a multistandard application environment in combination with a multistandard decoder such as for example TDA8310, TDA9143 or TDA9321H.

The SAB9079HS inserts one or two live video signals with reduced sizes into the main/display video signal. All video signals are expected to be analog baseband signals. The analog signals are stripped signals without sync. Therefore the luminance signal is referred to as Y\*. The conversion into the digital environment and back is done on-chip as well as the internal clock generation.

The SAB9079HS is suitable for single PIP, double window and multi PIP applications.

### ORDERING INFORMATION

TYPE NUMBER	PACKAGE		
	NAME	DESCRIPTION	VERSION
SAB9079HS	SQFP128	plastic shrink quad flat package; 128 leads (lead length 1.6 mm); body 14 × 20 × 2.72 mm	SOT387-3

# Multistandard Picture-In-Picture (PIP) controller

SAB9079HS

**QUICK REFERENCE DATA**

SYMBOL	PARAMETER	CONDITIONS	MIN.	TYP.	MAX.	UNIT
<b>Supplies</b>						
V <sub>DD(C)</sub>	digital supply voltage for the core		3.0	3.3	3.6	V
V <sub>DD(P)</sub>	digital supply voltage for the periphery		4.5	5.0	5.5	V
V <sub>DDA</sub>	analog supply voltage		3.0	3.3	3.6	V
I <sub>DD(C)</sub>	digital supply current for the core		tbf	115	tbf	mA
I <sub>DD(P)</sub>	digital supply current for the periphery		tbf	10	tbf	mA
I <sub>DDA</sub>	analog supply current		–	170	210	mA
<b>PLL</b>						
f <sub>osc</sub>	oscillator frequency	3584 × HSYNC	–	56	–	MHz
f <sub>sys</sub>	system frequency	1792 × HSYNC	–	28	–	MHz
		896 × HSYNC	–	14	–	MHz
		448 × HSYNC	–	7	–	MHz
B <sub>loop</sub>	loop bandwidth		–	4	–	kHz
t <sub>jitter</sub>	short term stability	jitter during 64 μs	–	–	4	ns
ζ	damping factor		–	0.7	–	

Multistandard Picture-In-Picture (PIP) Controller

SAB9079HS

BLOCK DIAGRAM

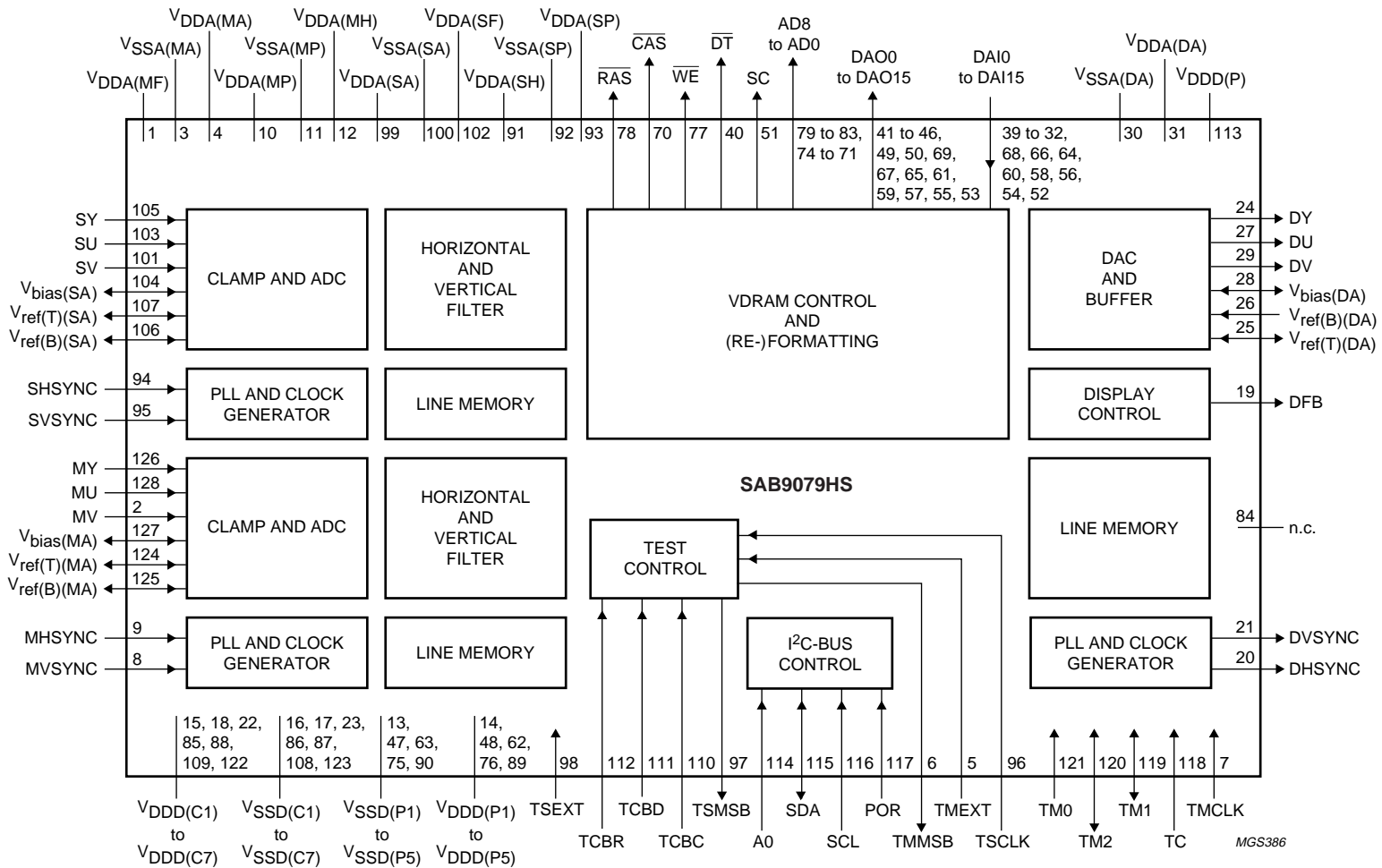

Fig.1 Block diagram.

# Multistandard Picture-In-Picture (PIP) controller

SAB9079HS

## PINNING

SYMBOL	PIN	I/O	DESCRIPTION
V <sub>DDA(MF)</sub>	1	S	analog supply voltage for main channel front-end (3.3 V)
MV	2	I	analog V input of main channel
V <sub>SSA(MA)</sub>	3	S	analog ground for main channel ADCs
V <sub>DDA(MA)</sub>	4	S	analog supply voltage for main channel ADCs (3.3 V)
TMEXT	5	I	set main PLL input for external mode (CMOS levels)
TMMSB	6	O	test main MSB output of PLL counter (CMOS levels)
TMCLK	7	I	test clock main input (CMOS levels)
MVSYNC	8	I	vertical sync input for main channel (CMOS levels with hysteresis)
MHSYNC	9	I	horizontal sync input for main channel (CMOS levels with hysteresis)
V <sub>DDA(MP)</sub>	10	S	analog supply voltage for main channel PLL (3.3 V)
V <sub>SSA(MP)</sub>	11	S	analog ground for main channel PLL
V <sub>DDA(MH)</sub>	12	S	supply of main HSYNC input (5.0 V)
V <sub>SSD(P1)</sub>	13	S	digital ground 1 for periphery; note 1
V <sub>DDD(P1)</sub>	14	S	digital supply voltage 1 for periphery (5.0 V); note 2
V <sub>DDD(C1)</sub>	15	S	digital supply voltage 1 for core (3.3 V); note 3
V <sub>SSD(C1)</sub>	16	S	digital ground 1 for core; note 4
V <sub>SSD(C2)</sub>	17	S	digital ground 2 for core; note 4
V <sub>DDD(C2)</sub>	18	S	digital supply voltage 2 for core (3.3 V); note 3
DFB	19	O	fast blanking control output (CMOS levels)
DHSYNC	20	O	horizontal sync output (CMOS levels)
DVSYNC	21	O	vertical sync output (CMOS levels)
V <sub>DDD(C3)</sub>	22	S	digital supply voltage 3 for core (3.3 V); note 3
V <sub>SSD(C3)</sub>	23	S	digital ground 3 for core; note 4
DY	24	O	analog Y* output of DAC
V <sub>ref(T)(DA)</sub>	25	I/O	analog top reference for DACs
V <sub>ref(B)(DA)</sub>	26	I/O	analog bottom reference for DACs
DU	27	O	analog U output of DAC
V <sub>bias(DA)</sub>	28	I/O	analog voltage reference DACs
DV	29	O	analog V output of DAC
V <sub>SSA(DA)</sub>	30	S	analog ground for DACs
V <sub>DDA(DA)</sub>	31	S	analog supply voltage for DACs (3.3 V)
DAI7	32	I	memory input data bit 7 (CMOS levels)
DAI6	33	I	memory input data bit 6 (CMOS levels)
DAI5	34	I	memory input data bit 5 (CMOS levels)
DAI4	35	I	memory input data bit 4 (CMOS levels)
DAI3	36	I	memory input data bit 3 (CMOS levels)
DAI2	37	I	memory input data bit 2 (CMOS levels)
DAI1	38	I	memory input data bit 1 (CMOS levels)
DAI0	39	I	memory input data bit 0 (CMOS levels)
D $\bar{T}$	40	O	memory data transfer (CMOS levels)

# Multistandard Picture-In-Picture (PIP) controller

SAB9079HS

SYMBOL	PIN	I/O	DESCRIPTION
DAO0	41	O	memory output data bit 0 (CMOS levels)
DAO1	42	O	memory output data bit 1 (CMOS levels)
DAO2	43	O	memory output data bit 2 (CMOS levels)
DAO3	44	O	memory output data bit 3 (CMOS levels)
DAO4	45	O	memory output data bit 4 (CMOS levels)
DAO5	46	O	memory output data bit 5 (CMOS levels)
V <sub>SSD(P2)</sub>	47	S	digital ground 2 for periphery; note 1
V <sub>DDD(P2)</sub>	48	S	digital supply voltage 2 for periphery (5.0 V); note 2
DAO6	49	O	memory output data bit 6 (CMOS levels)
DAO7	50	O	memory output data bit 7 (CMOS levels)
SC	51	O	memory shift clock output (CMOS levels)
DAI15	52	I	memory input data bit 15 (CMOS levels)
DAO15	53	O	memory output data bit 15 (CMOS levels)
DAI14	54	I	memory input data bit 14 (CMOS levels)
DAO14	55	O	memory output data bit 14 (CMOS levels)
DAI13	56	I	memory input data bit 13 (CMOS levels)
DAO13	57	O	memory output data bit 13 (CMOS levels)
DAI12	58	I	memory input data bit 12 (CMOS levels)
DAO12	59	O	memory output data bit 12 (CMOS levels)
DAI11	60	I	memory input data bit 11 (CMOS levels)
DAO11	61	O	memory output data bit 11 (CMOS levels)
V <sub>DDD(P3)</sub>	62	S	digital supply voltage 3 for periphery (5.0 V); note 2
V <sub>SSD(P3)</sub>	63	S	digital ground 3 for periphery; note 1
DAI10	64	I	memory input data bit 10 (CMOS levels)
DAO10	65	O	memory output data bit 10 (CMOS levels)
DAI9	66	I	memory input data bit 9 (CMOS levels)
DAO9	67	O	memory output data bit 9 (CMOS levels)
DAI8	68	I	memory input data bit 8 (CMOS levels)
DAO8	69	O	memory output data bit 8 (CMOS levels)
CAS	70	O	memory column address strobe output (CMOS levels)
AD0	71	O	memory address output bit 0 (CMOS levels)
AD1	72	O	memory address output bit 1 (CMOS levels)
AD2	73	O	memory address output bit 2 (CMOS levels)
AD3	74	O	memory address output bit 3 (CMOS levels)
V <sub>SSD(P4)</sub>	75	S	digital ground 4 for periphery; note 1
V <sub>DDD(P4)</sub>	76	S	digital supply voltage 4 for periphery (5.0 V); note 2
WE	77	O	memory write enable output (CMOS levels)
RAS	78	O	memory row address strobe output (CMOS levels)
AD8	79	O	memory address output bit 8 (CMOS levels)
AD7	80	O	memory address output bit 7 (CMOS levels)
AD6	81	O	memory address output bit 6 (CMOS levels)

# Multistandard Picture-In-Picture (PIP) controller

SAB9079HS

SYMBOL	PIN	I/O	DESCRIPTION
AD5	82	O	memory address output bit 5 (CMOS levels)
AD4	83	O	memory address output bit 4 (CMOS levels)
n.c.	84	–	not used in application
V <sub>DDD(C4)</sub>	85	S	digital supply voltage 4 for core (3.3 V); note 3
V <sub>SSD(C4)</sub>	86	S	digital ground 4 for core; note 4
V <sub>SSD(C5)</sub>	87	S	digital ground 5 for core; note 4
V <sub>DDD(C5)</sub>	88	S	digital supply voltage 5 for core (3.3 V); note 3
V <sub>DDD(P5)</sub>	89	S	digital supply voltage 5 for periphery (5.0 V); note 2
V <sub>SSD(P5)</sub>	90	S	digital ground 5 for periphery; note 1
V <sub>DDA(SH)</sub>	91	S	supply of sub HSYNC input (5.0 V)
V <sub>SSA(SP)</sub>	92	S	analog ground for sub channel PLL
V <sub>DDA(SP)</sub>	93	S	analog supply voltage for sub channel PLL (3.3 V)
SHSYNC	94	I	horizontal sync input for sub channel (CMOS levels with hysteresis)
SVSYNC	95	I	vertical sync input for sub channel (CMOS levels with hysteresis)
TSCLK	96	I	test clock input for sub (CMOS levels)
TSMSB	97	O	test sub MSB output for PLL counter (CMOS levels)
TSEXT	98	I	set sub PLL input for external mode (CMOS levels)
V <sub>DDA(SA)</sub>	99	S	analog supply voltage for sub channel ADCs (3.3 V)
V <sub>SSA(SA)</sub>	100	S	analog ground for sub channel ADCs
SV	101	I	analog V input of sub channel
V <sub>DDA(SF)</sub>	102	S	analog supply voltage for sub channel frontend (3.3 V)
SU	103	I	analog U input of sub channel
V <sub>bias(SA)</sub>	104	I/O	analog bias reference input for sub channel ADCs
SY	105	I	analog Y* input of sub channel
V <sub>ref(B)(SA)</sub>	106	I/O	analog bottom reference for sub channel ADCs
V <sub>ref(T)(SA)</sub>	107	I/O	analog top reference for sub channel ADCs
V <sub>SSD(C6)</sub>	108	S	digital ground 6 for core; note 4
V <sub>DDD(C6)</sub>	109	S	digital supply voltage 6 for core (3.3 V); note 3
TCBC	110	I	test control block clock input (CMOS levels)
TCBD	111	I	test control block data input (CMOS levels)
TCBR	112	I	test control block reset input (CMOS levels)
V <sub>DDD(P)</sub>	113	S	digital supply voltage for periphery (5.0 V); note 5
A0	114	I	address select pin input (I <sup>2</sup> C-bus) (CMOS levels)
SDA	115	I/O	serial input data/ACK output (I <sup>2</sup> C-bus) (CMOS input levels)
SCL	116	I	serial clock input (I <sup>2</sup> C-bus) (CMOS levels)
POR	117	I	power-on reset input (CMOS levels with hysteresis and pull-up resistor to V <sub>DD</sub> )
TC	118	I	test control input (CMOS levels)
TM1	119	I/O	test mode input/output (CMOS levels with hysteresis and pull-up resistor to V <sub>DD</sub> )
TM2	120	I/O	test mode input/output (CMOS levels with hysteresis and pull-up resistor to V <sub>DD</sub> )
TM0	121	I	test mode input (CMOS levels)
V <sub>DDD(C7)</sub>	122	S	digital supply voltage 7 for core (3.3 V); note 3

## Multistandard Picture-In-Picture (PIP) controller

SAB9079HS

SYMBOL	PIN	I/O	DESCRIPTION
$V_{SSD(C7)}$	123	S	digital ground 7 for core; note 4
$V_{ref(T)(MA)}$	124	I/O	analog top reference for main channel ADCs
$V_{ref(B)(MA)}$	125	I/O	analog bottom reference for main channel ADCs
MY	126	I	analog $Y^*$ input for main channel
$V_{bias(MA)}$	127	I/O	analog bias reference for main channel ADCs
MU	128	I	analog U input for main channel

### Notes

1. All periphery  $V_{SS(P)}$  are internally connected to each other, unless otherwise specified.
2. All periphery  $V_{DD(P)}$  are internally connected to each other, unless otherwise specified.
3. All core  $V_{DD(C)}$  are internally connected to each other.
4. All core  $V_{SS(C)}$  are internally connected to each other.
5. This pin is NOT connected to the other periphery  $V_{DD(P)}$ .



# Multistandard Picture-In-Picture (PIP) controller

## SAB9079HS

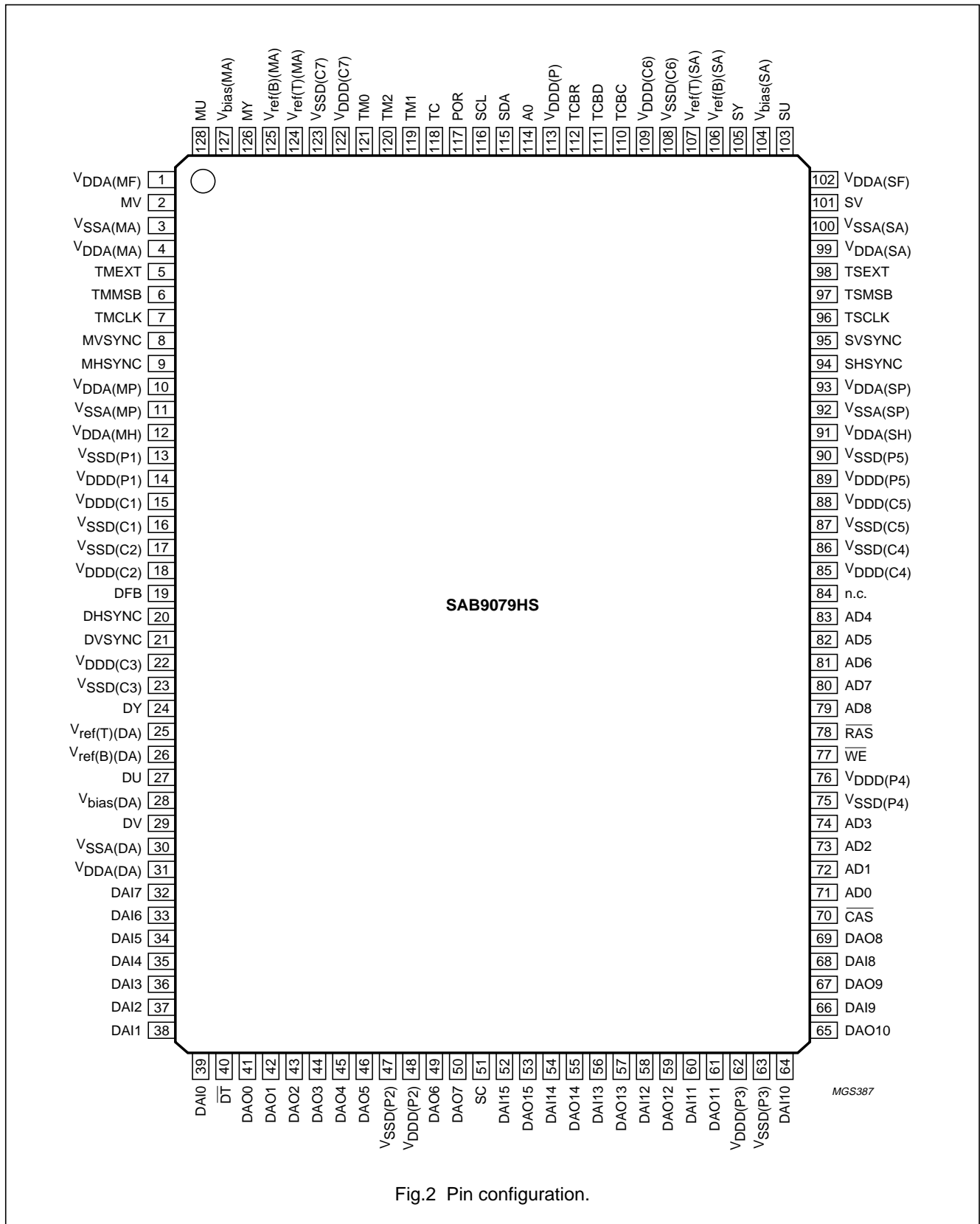

Fig.2 Pin configuration.

Multistandard Picture-In-Picture (PIP) controller

SAB9079HS

**SYSTEM DESCRIPTION**

**PIP modes**

An overview of the general PIP modes is given in Figs 3, 4 and 5. These pictures do not refer to all possible modes the device can handle. These modes are guaranteed only when sufficient memory is available and enough time is available to fetch all data from the memory.

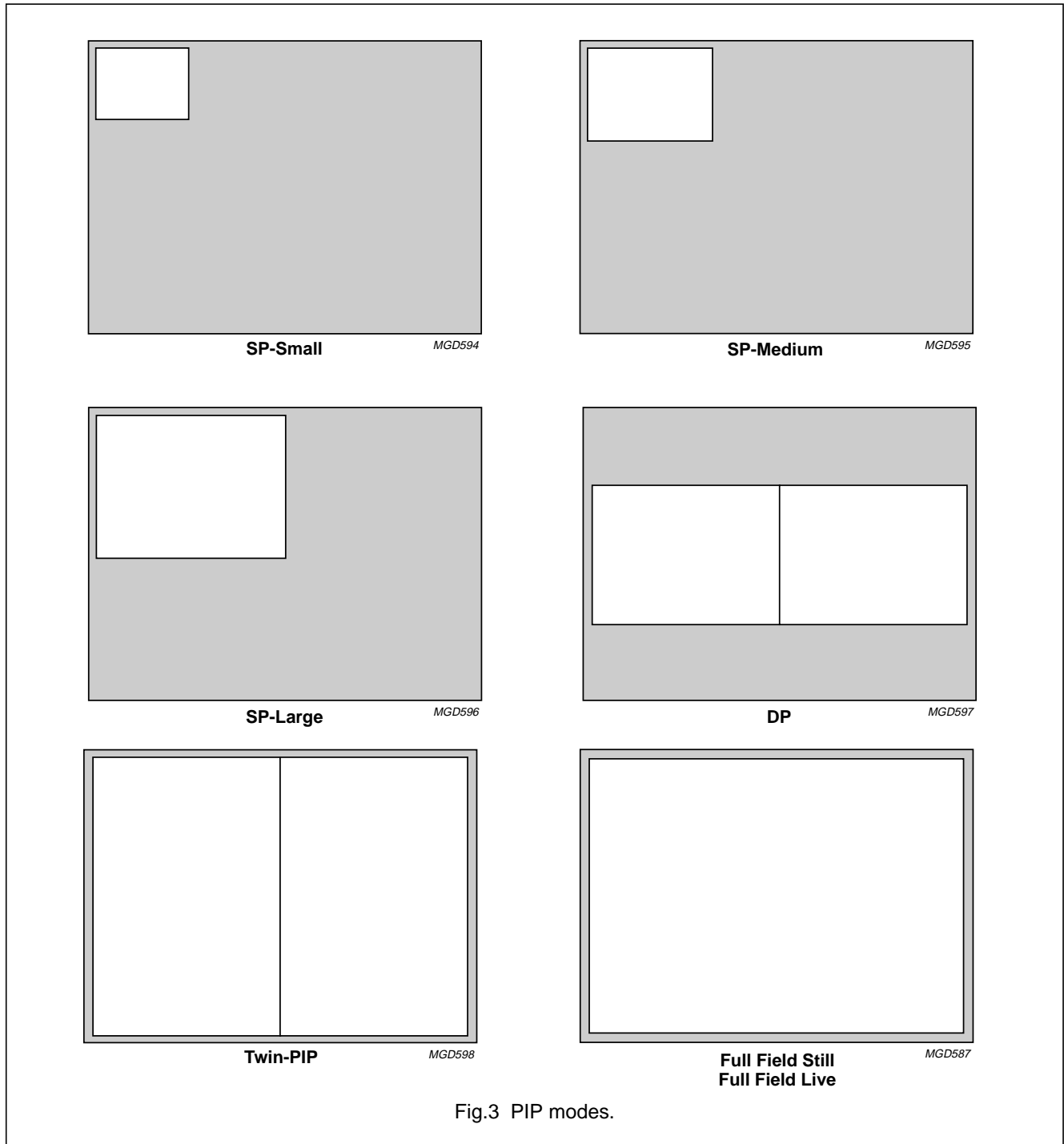

Fig.3 PIP modes.

# Multistandard Picture-In-Picture (PIP) controller

SAB9079HS

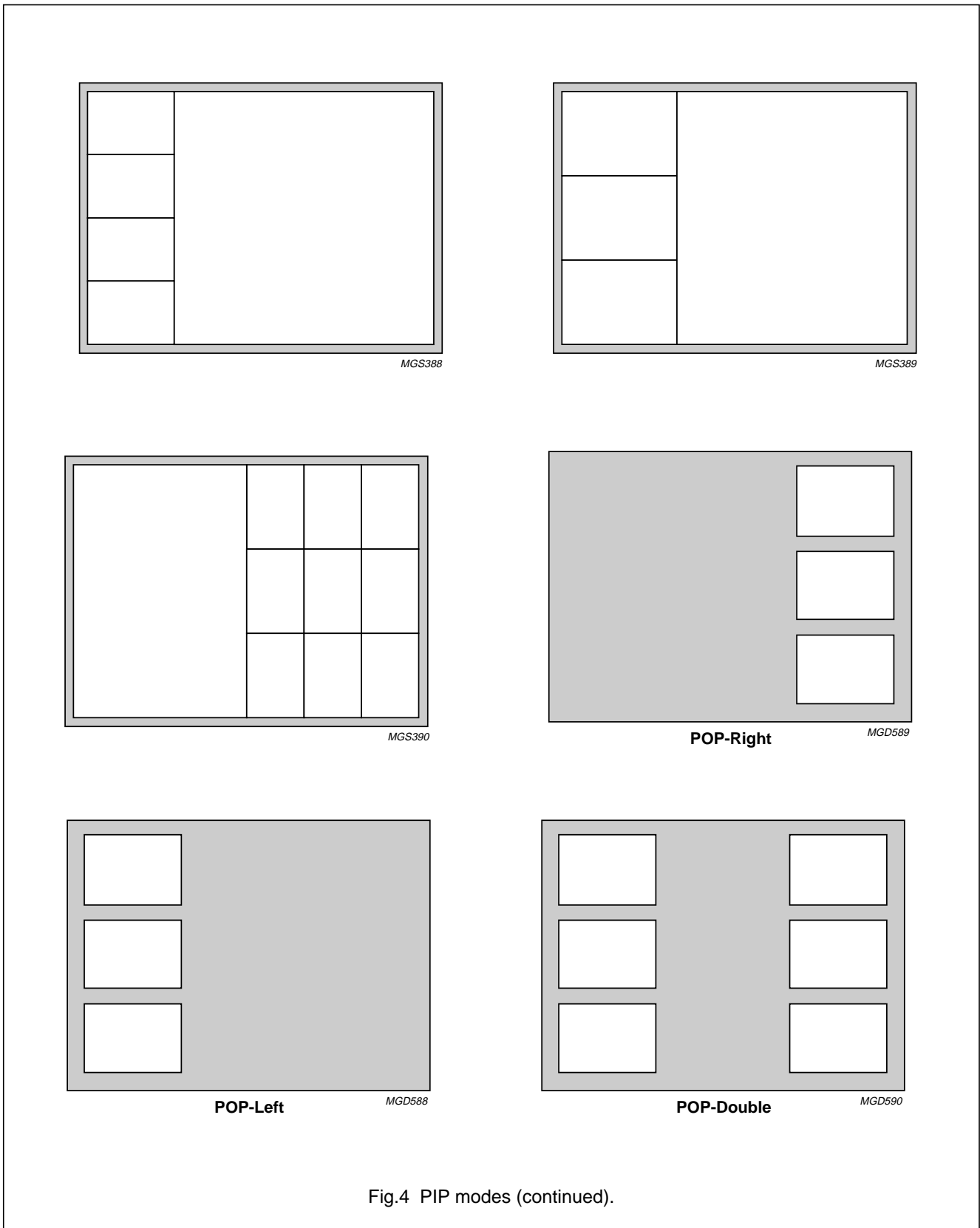
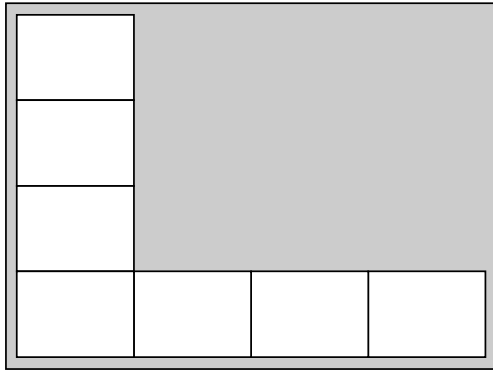

Fig.4 PIP modes (continued).

Multistandard Picture-In-Picture (PIP)  
controller

SAB9079HS



**MP7** *MGD591*

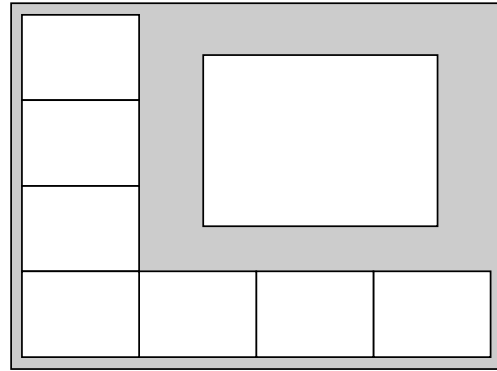

**MP8** *MGD592*

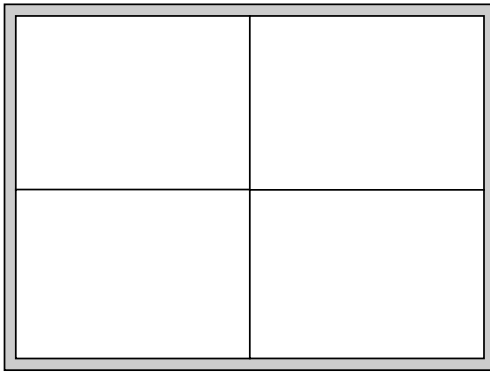

**Quatro** *MGD584*

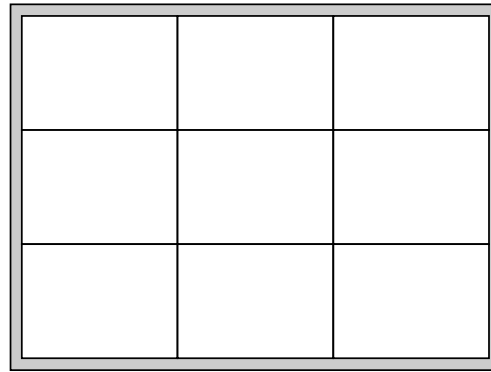

**MP9** *MGD585*

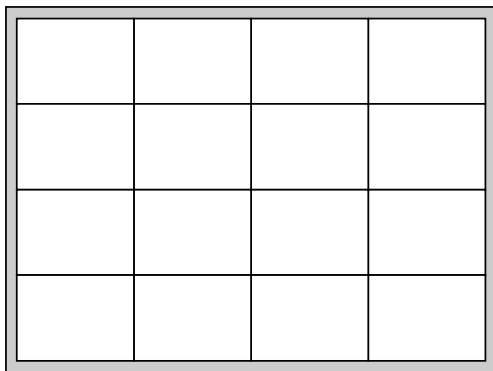

**MP16** *MGD586*

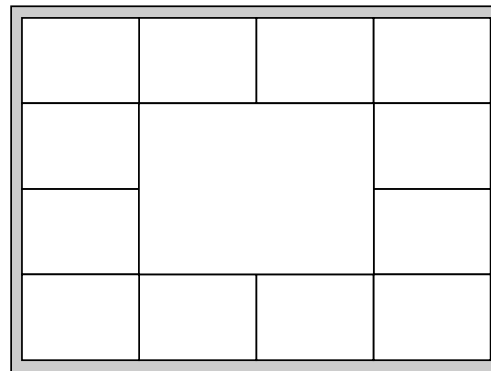

**MP13** *MGL925*

Fig.5 PIP modes (continued).

# Multistandard Picture-In-Picture (PIP) controller

SAB9079HS

### Acquisition window

The acquisition window is 720 pixels. This is related to a whole line of 896 pixels. So for PAL  $\frac{720}{896} \times 64 \mu s$  will be acquired from the active video. For NTSC this will be slightly less  $\frac{720}{896} \times 63.5 \mu s$ .

The vertical acquisition window is 228 lines for NTSC and 276 lines for PAL. Data will be acquired in a 4 : 2 : 2 format. The acquisition clock is  $896 \times HSYNC$ .

### Acquisition fine positioning

All I<sup>2</sup>C-bus settings relate to the incoming HSYNC, whether this is a real HSYNC or a burstkey for horizontal positioning. The same applies for the incoming VSYNC for vertical positioning. The relationships between the acquisition window and the internal clamp pulse are illustrated in Fig.6. In an application the clamp pulse must be positioned, by the I<sup>2</sup>C-bus, between the HSYNC and the start of the active video of the incoming signal.

### Display window

The display window available for PIP pictures is also 720 pixels wide, related to a 896 pixels line. The vertical display window is 228 lines for NTSC and 276 lines for PAL.

### Background window

The origin of the display window is referenced to the origin of the background window. The background area is 768 pixels wide. Vertically it is 238 lines for NTSC and 286 lines for PAL.

### Display fine positioning

The I<sup>2</sup>C-bus defined fine positioning has relationships to the internal HSYNC and VSYNC as illustrated in Fig.7.

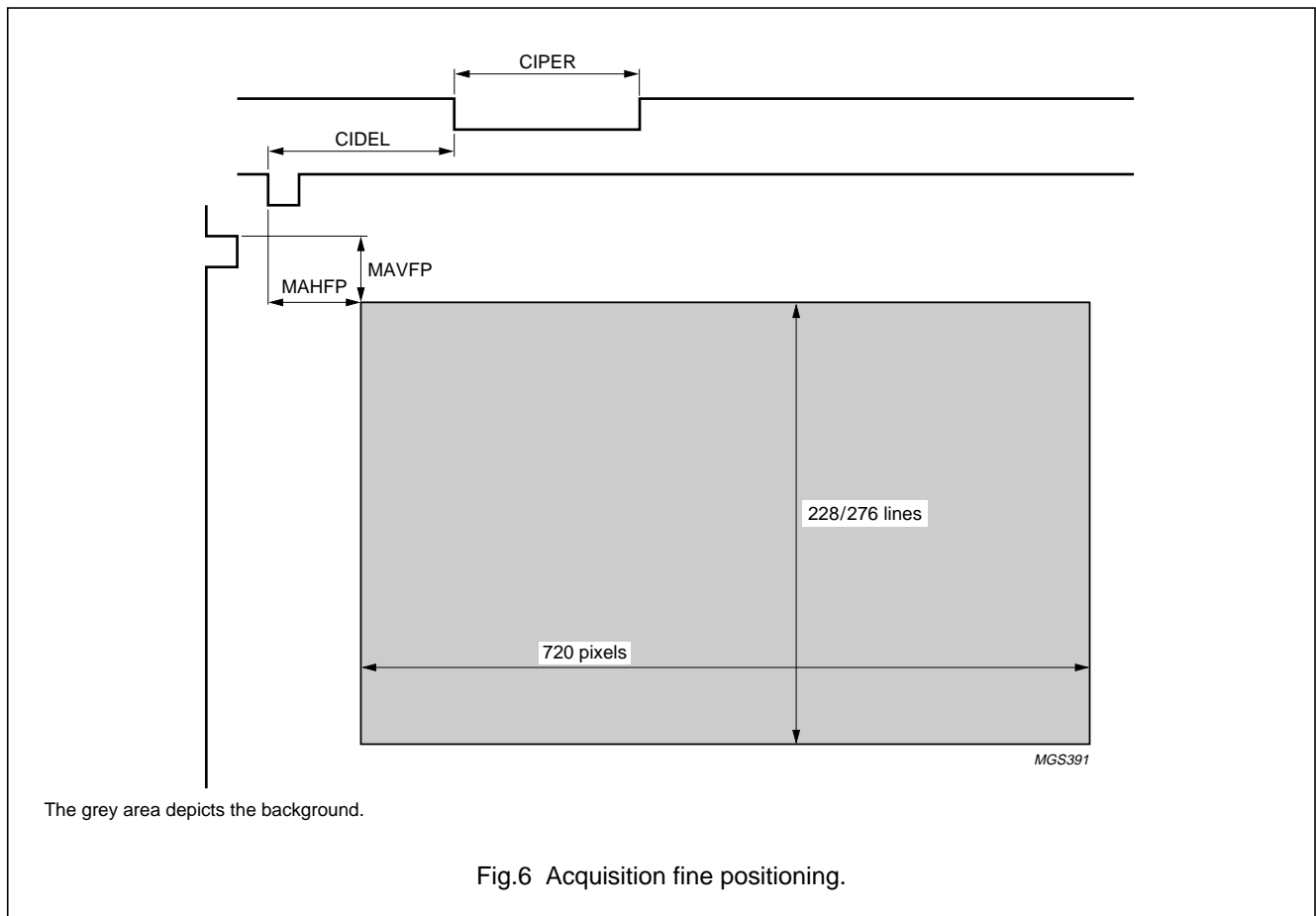

Multistandard Picture-In-Picture (PIP) controller

SAB9079HS

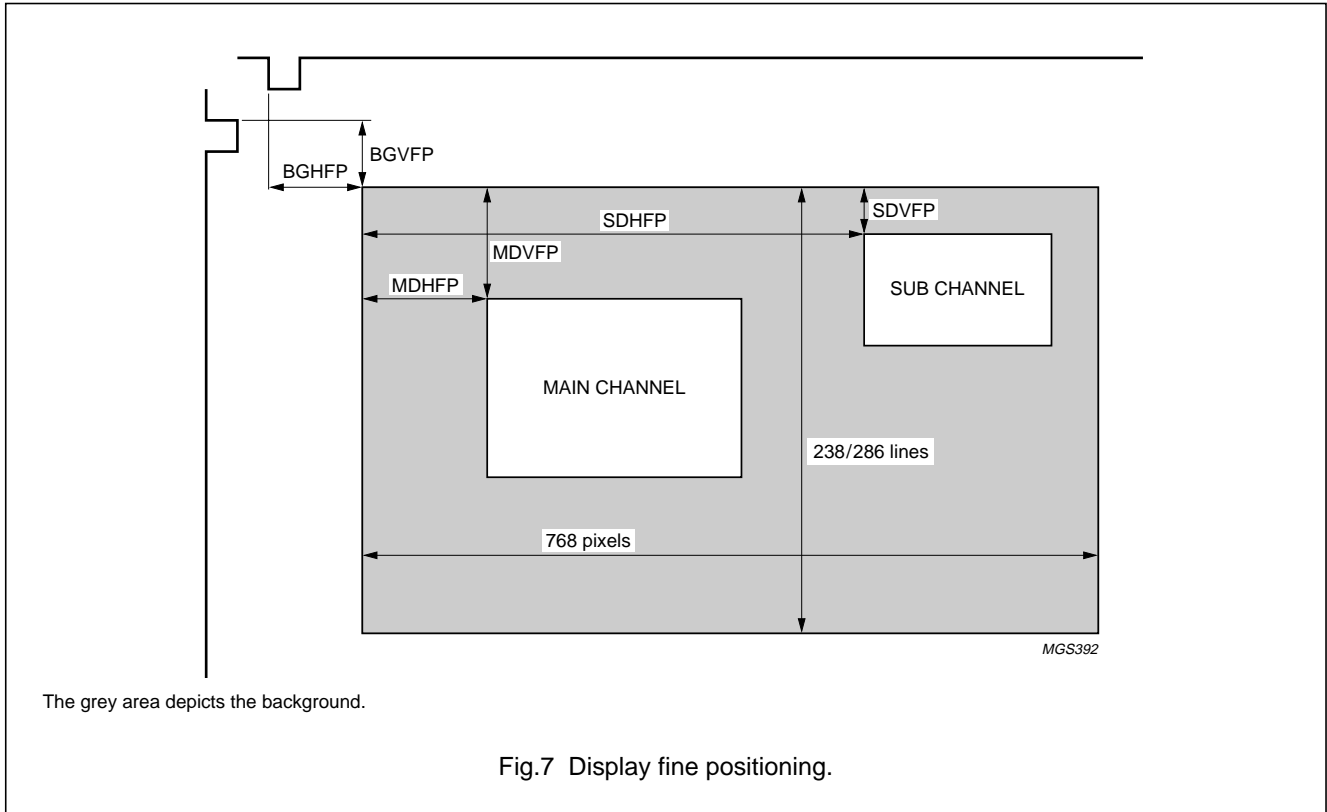

**YUV to RGB conversion matrix**

A YUV to RGB conversion matrix is available. The nine matrix coefficient values can be set by I<sup>2</sup>C-bus commands. Two sets can be defined; one for PAL and one for NTSC. The matrix must be switched on, otherwise a 1 : 1 conversion takes place and Y\*, U and V will be unmodified.

The conversion matrix is based on the following equations. All results (R, G and B) fall in the range from 0 to 1. Any results outside of this range will be clipped to the nearest end value. It should be noted that gamma correction is not applied as is common practice. The end of this section contains an example.

Normalised Y, U and V (indicated by subscript 'a') are given by the following four equations:

1.  $Y_a = x \times R_a + y \times G_a + z \times B_a$
2.  $x + y + z = 1$
3.  $U_a = B_a - Y_a$
4.  $V_a = R_a - Y_a$

Absolute or discrete (indicated by subscript 'd') values for Y, U and V are given by the following three equations:

1.  $Y_d = 255 \times Y_a$  (V),  $Y_a$  normalised (range 0 to 1)
2.  $U_d = 128 + 127 \times \frac{U_a}{1-z}$ ,  
 $U_a$  normalised (range -1 to +1)
3.  $V_d = 128 + 127 \times \frac{V_a}{1-x}$ ,  
 $V_a$  normalised (range -1 to +1)

## Multistandard Picture-In-Picture (PIP) controller

SAB9079HS

Absolute or discrete (indicated by subscript 'd') values for R, G and B are given by the following three equations:

$$1. \quad R_d = Y_d + \frac{255}{127} \times (V_d - 128) \times (1 - x)$$

$$2. \quad G_d = Y_d - \frac{255}{127} \times \left(\frac{x}{y}\right) \times (1 - x) \times (V_d - 128) - \frac{255}{127} \times \left(\frac{z}{y}\right) \times (1 - z) \times (U_d - 128)$$

$$3. \quad B_d = Y_d + \frac{255}{127} \times (U_d - 128) \times (1 - z)$$

The implementation of a matrix with 9 coefficients is shown in Table 1.

**Table 1** Matrix coefficients

YUV TO RGB MATRIX COEFFICIENTS	$Y_d$	$U_d$	$V_d$
	COFACTOR: $Y_d$	COFACTOR: $2 \times (U_d - 128)$	COFACTOR: $2 \times (V_d - 128)$
R	$ry = 1$	$ru = 0$	$rv = \frac{255}{254} \times (1 - x)$
G	$gy = 1$	$gu = -\frac{255}{254} \times \frac{z}{y} \times (1 - z)$	$gv = -\frac{255}{254} \times \frac{x}{y} \times (1 - x)$
B	$by = 1$	$bu = \frac{255}{254} \times (1 - z)$	$bv = 0$

So, for example;

$$R = ry \times Y_d + ru \times 2 \times (U_d - 128) + rv \times 2 \times (V_d - 128)$$

Table 2 shows how the coefficients can be calculated for a specific case where  $x = 0.299$ ,  $y = 0.587$  and  $z = 0.114$ .

Calculation of  $xv:y*128$  (rounded to the nearest integer), translates to a binary value. Calculation of  $xu:zv$ : translates to a binary value with the coefficients for the binary bits:  $-1, \frac{1}{2}, \frac{1}{4}, \frac{1}{8}, \frac{1}{16}, \frac{1}{32}, \frac{1}{64}, \frac{1}{128}$  (LSB).

**Table 2** Coefficient calculation

COEFFICIENT	EXPRESSION	DECIMAL VALUE	BINARY VALUE
ry	1	1	10000000
ru	0	0	00000000
rv	$\frac{255}{254} \times (1 - x)$	0.704	01011010
gy	1	1	10000000
gu	$-\frac{255}{254} \times \frac{z}{y} \times (1 - z)$	-0.173	11101010
gv	$-\frac{255}{254} \times \frac{x}{y} \times (1 - x)$	-0.358	11010010
by	1	1	10000000
bu	$\frac{255}{254} \times (1 - z)$	0.889	01110010
bv	0	0	00000000

## Multistandard Picture-In-Picture (PIP) controller

SAB9079HS

### PLL phase shift compensation for VCR

When a VCR is applied as source for the main channel, a large phase jump can appear when the VCR head switches to another field. Since this phenomenon occurs around the VSYNC, its effects can be compensated. A prediction mechanism generates a compensation window around the VSYNC. This window can be manipulated with two parameters; VsPre and VsPost.

- VsPre sets the number of lines before the predicted VSYNC, where the compensation window will start
- VsPost sets the number of lines after the actual VSYNC, where the compensation window will end.

### I<sup>2</sup>C-bus

I<sup>2</sup>C-BUS CONTROL

The SAB9079HS is a slave receiver/transmitter. The protocols are given in Tables 3 and 5.

**Table 3** I<sup>2</sup>C-bus slave receiver protocol

S	SLAVE	A	SUB	A	DATA	A	DATA	A	P
---	-------	---	-----	---	------	---	------	---	---

**Table 4** Description of Table 3

SYMBOL	DESCRIPTION
S	START condition
A	acknowledge bit (generated by SAB9079HS)
P	STOP condition
SLAVE	slave address; the data transmission starts with the slave address byte SLV (2CH or 2EH); the LSB of the SLV byte is the R/W bit which is logic 0 in slave receiver mode
SUB	sub address byte; the SUB byte indicates the sub address which has to be written; if more than one data byte is send (as above) the internal sub address counter is automatically incremented after each data byte
DATA	data byte; the data byte is the actual data written to the sub address; the functions of each sub address are explained in the following Sections

**Table 5** I<sup>2</sup>C-bus slave transmitter protocol

S	SLAVE	A	DATA	A	DATA	A	DATA	N	P
---	-------	---	------	---	------	---	------	---	---

**Table 6** Description of Table 5

SYMBOL	DESCRIPTION
S	START condition
A	acknowledge bit; after the SLV generated by the SAB9079HS; after the DATA generated by the master
N	acknowledge not bit; given by the master after the last data byte
P	STOP condition
SLAVE	slave address; the data transmission starts with the slave address byte SLV (2DH or 2FH); the LSB of the SLV byte is the R/W bit which is logic 1 in slave transmitter mode
DATA	data byte; this is put on the bus by SAB9079HS in an auto increment mode; if the master gives an acknowledge the next data byte is sent; if the SAB9079HS has sent all its data it starts again with the first data byte and the sequence is repeated; this continues until an acknowledge not is given by the master



## Multistandard Picture-In-Picture (PIP) controller

SAB9079HS

The SAB9079HS has 8 read/status registers. The last 7 registers are reserved for future purposes. Reading a reserved register will return zero values.

The SAB9079HS has 192 write registers. Writing to a reserved register is not allowed.

An overview of all write registers is given in Table 7.

**Table 7** Description of write registers

SUB ADDRESS RANGE	PURPOSE
00H to 04H	display
05H to 11H	positioning and sizing of PIPs
12H to 17H	decoder settings
18H to 1FH	acquisition control
20H to 25H	decoder and PLL settings
26H to 28H	reserved
29H to 2AH	decoder and PLL settings
2BH to 2FH	replay settings
30H to 37H	border and colour settings
38H to 3CH	OSD controls
3DH to 4EH	YUV to RGB conversion matrix settings
4FH to 5FH	extra decoder settings
60H to 7FH	reserved
80H to DFH	OSD characters
E0H to FFH	reserved

### I<sup>2</sup>C-BUS READ REGISTERS

The SAB9079HS has 8 read/status registers. The register currently used are listed in Table 8. The remaining 7 are reserved for future purposes. Reading a reserved register will return zero values.

**Table 8** I<sup>2</sup>C-bus read registers

SUB ADDRESS	DATA BYTES							
	BIT 7	BIT 6	BIT 5	BIT 4	BIT 3	BIT 2	BIT 1	BIT 0
00H	SNonInt	Mask ID	RepChano					
01H	reserved							
02H	reserved							
03H	reserved							
04H	reserved							
05H	reserved							
06H	reserved							
07H	reserved							

## Multistandard Picture-In-Picture (PIP) controller

## SAB9079HS

### *SNonInt*

This bit indicates the internal interface status of the sub channel. A logic 0 indicates that the channel is in interlaced mode, a logic 1 indicates that the channel is non-interlaced.

### *Mask ID*

This bit gives the version number of the chip. A logic 0 indicates that a SAB9079N1 is used, a logic 1 indicates that a SAB9079N2 is used.

### *RepChano*

These bits indicate the present picture number, counting from 0, where replay acquisition is writing.

### I<sup>2</sup>C-BUS DISPLAY SETTING REGISTERS

#### *MPIPON and SPIPON*

If MPIPON is set to logic 1 (see Table 10) the main PIP is on. If it is set to logic 0 the main PIP is off. If SPIPON is set to logic 1 the sub PIPs are on, in accordance with the scheme of the PIPG bits (see Section "Positioning and sizing of PIPs"). If SPIPON is set to logic 0 all the sub PIPs are off. This can also be achieved by setting all PIPG bits to zero.

#### *MFreeze and SFreeze*

MFreeze and SFreeze control the writing of data to the VDRAM. If set to logic 0 the writing to the VDRAM is disabled after the next VSYNC. If set to logic 1 the writing is enabled after the next VSYNC.

#### *I<sup>2</sup>CHold*

The I<sup>2</sup>C-bus hold bit is set to logic 0 (default). This means that all I<sup>2</sup>C-bus data is directly clocked into the internal registers. A part of the I<sup>2</sup>C-bus data will be clocked in on the next VSYNC (e.g. the reduction factors and the display positioning). If the I<sup>2</sup>CHold bit is logic 1 that part of the I<sup>2</sup>C-bus will not be clocked in on the next VSYNC. To make the data available the I<sup>2</sup>CHold bit should be set to logic 0 again. This function is useful when much data has to be sent and a screen update is not allowed when sending this data. A list of I<sup>2</sup>C-bus registers which are clocked in on a VSYNC is given below:

- MPIPON and SPIPON
- MFreeze, SFreeze and FillSet
- DNonInt, MNonInt and SNonInt
- PRIO

- BGHfp, BGVfp, MDHfp, MDVfp, SDHfp and SDVfp
- MHPic, MVPic, SHPic, SVPic, SHDis and SVDIs
- PIPG<sub>c,r</sub>
- MHRed, MVRed, SHRed, SVRed, MLSel, SLSel and SBSel
- OSDHfp, OSDVfp, OSDHDis and OSDVDis.

#### *FillSet and FillOff*

The FillSet bit sets the colour of all sub PIPs immediately to a 30% grey value if it is set to logic 1. If FillSet is set to logic 0 then the 30% grey PIPs stay until the data in the VDRAM is updated (unfrozen). This bit should be used in the event that a new PIP mode is made in which the VDRAM data becomes invalid. FillOff works the opposite to FillSet. If this bit is set all the VDRAM data is made visible in the PIPs and no PIP has a grey content. This bit is generally not used.

#### *MiS*

If the MiS bit is set to logic 0 the main and sub channels have their own independent memory spaces. If set to logic 1 the main and sub channels share the same memory space, this is only valid if the main and sub channels have the same reduction factors.

#### *YUVFilter*

These bits control the vertical filtering of 1 : 1 for both the Y\* and UV channels independently. Several display filter modes can be set with these bits. An overview is given in Table 9. The Y filter should not be used in vertical 1/4 modes.

**Table 9** Display filter modes

MODE	YUV FILTER
No filter	00H
UV 1 : 1 vertical filter	01H
Y 1 : 1 vertical filter	10H
YUV 1 : 1 vertical filter	11H

#### *CTE and LTE*

Colour Transient Enhancement (CTE) can be set on or off. Luminance Transient Enhancement (LTE) is controllable via a scale, setting the scale value to 0H means that LTE is off.

# Multistandard Picture-In-Picture (PIP) controller

SAB9079HS

### MFld and SFld

The number of fields stored in the VDRAM can be set with the MFld and SFld bits. There is a limit of 4 Mbits which can be stored. It is best to set these bits so that 3 fields are stored for the sub channel and 2 for the main channel, but this is not possible in all cases (large PIPs). Therefore, the number of fields stored can be reduced. This can result in some performance loss, e.g. if the sub channel is set to 1 field joint line errors can appear.

### IntOff, DNonInt, MNonInt and SNonInt

In automatic interlace mode (IntOff is logic 0) the device calculates whether interlaced or non-interlaced signals are applied and acts accordingly. This can be overruled by setting bit IntOff to logic 1. Bits DNonInt, MNonInt and SNonInt then determine the interlace. If the xNonInt bits are set to logic 0 the device is put in interlaced mode, if they are set to logic 1 the main, sub and/or display channels are put in non-interlaced mode. DNonInt overrules MNonInt (main and display channels are coupled).

### PalOff, DPal, MPal and SPal

In automatic mode (PalOff is logic 0) the device calculates what type of signal is applied, PAL or NTSC. In the event that the number of lines in a field is less than 287 it is assumed to be NTSC, otherwise it is assumed to be PAL. This can be overruled by setting PalOff to logic 1.

The xPal bits then determine the mode of the device. A logic 0 sets the device in NTSC mode, a logic 1 to PAL mode. DPAL overrules MPAL (main and display channels are coupled).

### PRIO, NipCoff, Fmt411, DFilt and Yth

The PRIO bit sets the priority between the main and sub channels. A logic 0 gives priority to the sub channel which means that the sub channel PIPs, if present, are placed on top of the main PIP. A logic 1 places the main PIP on top of the sub PIPs. The NipCoff bit determines whether a grey bar is inserted in case a NTSC PIP is displayed in a PIP with PAL PIP size. The missing lines are equally divided between the top part and the bottom part of the PIP window and made 30% grey. If this bit is logic 0 the grey bar is displayed, if this bit is logic 1 the grey bar is omitted and the PIP data is shifted up. The Fmt411 bit sets the YUV format. If this bit is logic 0 then the device is in 4 : 2 : 2 YUV mode, if this bit is logic 1 then the device is in 4 : 1 : 1 YUV mode. If the 4 : 2 : 2 format is used the memory use is larger, so some modes are not available and the length of a read/write cycle is larger. The Dfilt bit controls an interpolating filter to expand the internal 720 pixels data rate to the output data rate of 2 × 720 pixels in 1FH mode. If DFilt is logic 1 then the filter is on. The Yth<sub>(3:0)</sub> bits control the video output. If the current Y value is less than Yth × 16 then the fast blanking is switched off, and the original live background will be visible. This feature can be used to pick up sub-titles and display them as OSD anywhere on the screen.

**Table 10** overview of the I<sup>2</sup>C-bus sub addresses

SUB ADDRESS	DATA BYTES							
	BIT 7	BIT 6	BIT 5	BIT 4	BIT 3	BIT 2	BIT 1	BIT 0
00H	MPIPON	SPIPON	MFreeze	SFreeze	I <sup>2</sup> CHold	FillSet	FillOff	MiS
01H	–	–	–	–	MFld <sub>(1:0)</sub>		SFld <sub>(1:0)</sub>	
02H	YUVFilter <sub>(1:0)</sub>		–	–	CTE	LTE <sub>(2:0)</sub>		
03H	IntOff	DNonInt	MNonInt	SNonInt	Paloff	DPal	MPal	SPal
04H	PRIO	NipCoff	Fmt411	DFilt	Yth <sub>(3:0)</sub>			

## Multistandard Picture-In-Picture (PIP) controller

SAB9079HS

### POSITIONING AND SIZING OF PIPs

The basic principle is the same as in the SAB9076/77. The only difference is that the main channel can only display 1 PIP. The algorithm for the sub channel is similar. The difference for the sub channel is that the number of PIPs for each row and the offset of the first PIP is replaced by grid bits. In the matrix of 16 PIPs every PIP can be put on or off. The I<sup>2</sup>C-bus registers are given in Table 11.

#### BGHfp and BGVfp

The BGHfp and BGVfp bits control the horizontal (4 pixels/step) and vertical (2 line/field/step) background positioning (upper left corner).

#### SDHfp and SDVfp

The SDHfp and SDVfp bits control the horizontal (4 pixels/step) and vertical (1 line/field/step) sub display positioning (upper left corner).

#### SHPic and SVPic

Bit SHPic controls the horizontal size of the sub PIP in steps of 4 pixels (minimum is 8 pixels). Bit SVPic controls the vertical size of the sub PIP in steps of 1 line/field for NTSC or 2 lines/field for PAL.

#### SHDis and SVDIs

Bit SHDis controls the horizontal distance between the left sides of the sub PIPs on a row in steps of 4 pixels. Bit SVDIs controls the vertical distance between the top lines of sub PIPs in steps of 1 line (both Pal and NTSC). The distances should always be equal or larger than the picture sizes so that the PIPs of one channel do not overlap. In the event of single PIP modes SHDis should be set to maximum.

#### MDHfp and MDVfp

The MDHfp and MDVfp bits control the horizontal and vertical main display positioning.

#### MHPic and MVPic

Bit MHPic controls the horizontal size of the main PIP in steps of 4 pixels (minimum is 24 pixels). Bit MVPic controls the vertical size of the main PIP in steps of 1 line/field for NTSC or 2 lines/field for PAL.

#### PIPG<sub>row,col</sub>

The PIPG<sub>row,col</sub> bits make it possible to set each individual PIP on or off in a multi PIP mode. PIPs are numbered according to Table 12. Rows are numbered from top to bottom, columns are numbered from left to right.

**Table 11** I<sup>2</sup>C-bus registers for PIP

SUB ADDRESS	DATA BYTES							
	BIT 7	BIT 6	BIT 5	BIT 4	BIT 3	BIT 2	BIT 1	BIT 0
05H	BGHfp <sub>(3:0)</sub>				BGVfp <sub>(3:0)</sub>			
06H	SDHfp <sub>(7:0)</sub>							
07H	SDVfp <sub>(7:0)</sub>							
08H	SHPic <sub>(7:0)</sub>							
09H	SVPic <sub>(7:0)</sub>							
0AH	SHDis <sub>(7:0)</sub>							
0BH	SVDIs <sub>(7:0)</sub>							
0CH	MDHfp <sub>(7:0)</sub>							
0DH	MDVfp <sub>(7:0)</sub>							
0EH	MHPic <sub>(7:0)</sub>							
0FH	MVPic <sub>(7:0)</sub>							
10H	PIPG <sub>1,3</sub>	PIPG <sub>1,2</sub>	PIPG <sub>1,1</sub>	PIPG <sub>1,0</sub>	PIPG <sub>0,3</sub>	PIPG <sub>0,2</sub>	PIPG <sub>0,1</sub>	PIPG <sub>0,0</sub>
11H	PIPG <sub>3,3</sub>	PIPG <sub>3,2</sub>	PIPG <sub>3,1</sub>	PIPG <sub>3,0</sub>	PIPG <sub>2,3</sub>	PIPG <sub>2,2</sub>	PIPG <sub>2,1</sub>	PIPG <sub>2,0</sub>

# Multistandard Picture-In-Picture (PIP) controller

SAB9079HS

**Table 12** PIP numbering

ROW	COLUMN 0	COLUMN 1	COLUMN 2	COLUMN 3
0	PIPG <sub>0,0</sub>	PIPG <sub>0,1</sub>	PIPG <sub>0,2</sub>	PIPG <sub>0,3</sub>
1	PIPG <sub>1,0</sub>	PIPG <sub>1,1</sub>	PIPG <sub>1,2</sub>	PIPG <sub>1,3</sub>
2	PIPG <sub>2,0</sub>	PIPG <sub>2,1</sub>	PIPG <sub>2,2</sub>	PIPG <sub>2,3</sub>
3	PIPG <sub>3,0</sub>	PIPG <sub>3,1</sub>	PIPG <sub>3,2</sub>	PIPG <sub>3,3</sub>

**ACQUISITION CONTROL**

Acquisition control sets the reduction factors, the acquisition fine positioning and the channel selection bits are given in Table 13.

*SHRed, SVRed, MHRed and MVRed*

The reduction factors can be set in accordance with Table 14.

*SAHfp and SAVfp*

The SAHfp and SAVfp bits control the horizontal (2 pixels/step) and vertical (1 line/field/step) sub acquisition positioning (upper left corner). When SAHfp is set to logic 0, the sub channel will enter the freeze mode.

*MAHfp and MAVfp*

The MAHfp and MAVfp bits control the horizontal (2 pixels/step) and vertical (1 line/field/step) main acquisition positioning (upper left corner). When MAHfp is set to logic 0, the main channel will enter the freeze mode.

*SLSel and MLSel*

Bits SLSel and MLSel select which PIP is updated. A maximum of 16 PIPs can be displayed for the sub channel. The number counting is done from the left to right and from top to bottom.

If all PIPs are on (see Table 12) 16 PIPs are displayed. If PIPs are put off the maximum number is limited to the number of PIPs displayed. In the PIP mode where the main and sub channel have the same reduction factors the main channel can write in sub VDRAM address spaces according to the same numbering. In all other cases MLSel is inoperative and should be set to 0H. For replay and other trick modes more PIPs can be stored and addressed via the higher numbers (17 to 60). The numbers 61, 62 and 63 are not valid.

**Table 13** Acquisition and channel selection bits

SUB ADDRESS	DATA BYTES							
	BIT 7	BIT 6	BIT 5	BIT 4	BIT 3	BIT 2	BIT 1	BIT 0
18H	–		SVRed <sub>(2:0)</sub>		–		SHRed <sub>(2:0)</sub>	
19H	–		MVRed <sub>(2:0)</sub>		–		MHRed <sub>(2:0)</sub>	
1AH	SAHfp <sub>(7:0)</sub>							
1BH	SAVfp <sub>(7:0)</sub>							
1CH	MAHfp <sub>(7:0)</sub>							
1DH	MAVfp <sub>(7:0)</sub>							
1EH	–	–			SLSel <sub>(5:0)</sub>			
1FH	–	–			MLSel <sub>(5:0)</sub>			

# Multistandard Picture-In-Picture (PIP) controller

SAB9079HS

**Table 14** Reduction factors

BITS	HORIZONTAL		VERTICAL	
	MAIN	SUB	MAIN	SUB
0H	not valid	not valid	not valid	not valid
1H	$\frac{1}{1}$	$\frac{1}{1}$	$\frac{1}{1}$	$\frac{1}{1}$
2H	$\frac{1}{2}$	$\frac{1}{2}$	$\frac{1}{2}$	$\frac{1}{2}$
3H	$\frac{1}{3}$	$\frac{1}{3}$	$\frac{1}{3}$	$\frac{1}{3}$
4H	$\frac{1}{4}$	$\frac{1}{4}$	$\frac{1}{4}$	$\frac{1}{4}$
5H	$\frac{2}{3}$	not valid	not valid	not valid
6H	$\frac{1}{6}$	$\frac{1}{6}$	not valid	not valid
7H	$\frac{3}{4}$	not valid	not valid	not valid

**DECODER AND PLL SETTINGS**

*SYCIRef, SUCIRef, SVCIRef, MYCIRef, MUCIRef and MVCIRef*

The clamp reference level can be set separately for each of the 6 analog inputs; it acts as a wide range pedestal. Under normal conditions SYCIRef will be set to 0 and SUVCIRef will be set to 128.

*DHsel, FidOn, VFilt, UVPol, VSPol, FPol and CCON*

- DHsel determines the timing of the HSYNC pulse (burstkey = 0 or HSYNC = 1), for the display part
- FidOn enables the field identification position fine tuning; FidOn = 1 takes the value of registers 4FH or 57H; FidOn = 0 takes a hard wired default value
- VFilt enhances the vertical reduction filter for vertical reduction modes  $\frac{1}{3}$  and  $\frac{1}{4}$
- SUIVPol and MUIVPol invert the UV polarity of the YUV data
- DUVPol inverts the UV polarity of the border colours
- VSPol determines the active edge of the VSYNC (positive edge is logic 0 and negative edge is logic 1)
- FPol can invert the field ID of the incoming fields
- CCON enables the clamp correction circuit.

*IntCoff, FbDel and YDel*

Bit IntCoff sets the interlace correction. Interlace correction is put off if this bit is set to logic 1. FbDel<sub>(2:0)</sub> can adjust the fast blank delay in 8 steps of a  $\frac{1}{2}$  28 MHz clock cycle (−4 to +3); 0H is mid-scale. YDel adjusts the Y delay with respect to the UV delay; 0H is mid-scale from −4 to +3 pixels. YDel is done on the display side and therefore both channels, main and sub channels, will have an equal delay in the luminance.

*Pedestals*

On the acquisition sides YUV can be given an offset during the clamp. Using this mechanism minor offsets in the matrices can be adjusted. The steps are from −8 to +7 with a resolution of 1 LSB of the ADC.

*VSPre and VSPost*

VSPre is the number of lines before a VSYNC where the PLL is put in free-running mode. VSPost is the number of lines after the VSYNC where the PLL is still free-running. Outside this area the PLL is in normal mode.

# Multistandard Picture-In-Picture (PIP) controller

SAB9079HS

**Table 15** Decoder and PLL settings

SUB ADDRESS	DATA BYTES							
	BIT 7	BIT 6	BIT 5	BIT 4	BIT 3	BIT 2	BIT 1	BIT 0
12H	SYCIRef <sub>(7:0)</sub>							
13H	SUCIRef <sub>(7:0)</sub>							
14H	SVCIRef <sub>(7:0)</sub>							
15H	MYCIRef <sub>(7:0)</sub>							
16H	MUCIRef <sub>(7:0)</sub>							
17H	MVCIRef <sub>(7:0)</sub>							
20H	–	–	SFidOn	SVFilt	SUVPol	SVSPol	SFPol	SCCON
21H	DHsel	–	MFidOn	MVFilt	MUVPol	MVSPol	MFPol	MCCON
22H	IntCOff	FbDel <sub>(2:0)</sub>			DUVPol	YDel <sub>(2:0)</sub>		
23H	SPedestY <sub>(3:0)</sub>				MPedestY <sub>(3:0)</sub>			
24H	SPedestU <sub>(3:0)</sub>				MPedestU <sub>(3:0)</sub>			
25H	SPedestV <sub>(3:0)</sub>				MPedestV <sub>(3:0)</sub>			
29H	–	–	VSPre					
2AH	–	–	VSPost					

**REPLAY SETTINGS***DChaOff*

DChaOff is the channel offset for the display. It can be used in trick modes or software replay as the channel number to be displayed.

*DChaDis*

DChaDis is the number of internal VSYNCs between two stored and/or displayed fields.

*RepMax*

RepMax is the maximum number of different fields that will be stored in the memory during replay.

*RepInc*

Repinc is the auto increment used during replay acquisition/display.

*RepAcq, RepDisp, RepCont, DCha+ and DCha–*

Bit RepAcq enables the replay acquisition loop, in which pictures are stored with DChaDis as time distance. Bit RepDisp enables the display of stored pictures. When bit RepCont = 1 it enables a continuous looping during display, when bit RepCont = 0 it enables the step function. Bit DCha+ enables one step forward (next picture), bit DCha– enables one step back in time (previous picture). It should be noted that if bits RepAcq and RepDisp are both logic 1 at the same time, the internal display number will be the present acquisition number minus 1.

# Multistandard Picture-In-Picture (PIP) controller

SAB9079HS

**Table 16** Replay settings

SUB ADDRESS	DATA BYTES							
	BIT 7	BIT 6	BIT 5	BIT 4	BIT 3	BIT 2	BIT 1	BIT 0
2BH	–	–	DChaOff <sub>(5:0)</sub>					
2CH	DChaDis <sub>(7:0)</sub>							
2DH	–	–	RepMax <sub>(5:0)</sub>					
2EH	DCha+	DCha–	RepAcq	RepDisp	RepCont	–	–	RGBOn <sup>(1)</sup>
2FH	–	–	Replnc <sub>(5:0)</sub>					

**Note**

1. RGBOn enables the YUV to RGB matrix. It is not related to the replay registers.

**BORDER AND COLOUR SETTINGS**

Several border and colour settings are given in Table 17.

*BHSize and BVSize*

Bits BHSize and BVSize control the horizontal and vertical border size in steps of 2 pixels and 1 line.

*OUVPol*

Bit OUVPol sets the UV polarity for all the OSD related colours.

*FBLON*

If bit FBLON is set to logic 1 the FBL pin is made HIGH under the condition that standard signals are applied. If PAL signals are applied, this function is overruled for the SAB9078HS.

*Shade*

Bit Shade gives the OSD characters a shade.

*OSDBLK*

Bit OSDBLK blanks all OSD characters but retains their values in memory.

*Colour registers*

The colour registers are all built-up in a similar way:

- Bit 6 is the on bit which determines whether the border (or OSD) is visible
- Bits 5 and 4 determine the brightness level of the colour (see Table 18)
- Bits 2, 1 and 0 determine the colour type (see Table 18)
- SB = Sub Border
- SBS = Sub Border Select (which PIP has a different border colour)
- MB = Main Border
- BG = Back Ground
- OSD is the OSD character
- OSDS = the background of the selected OSD character.

*SBSel*

The SBSel bits select which sub PIP has a different border colour, if SBSON is set to logic 1. The colour type can be set with SBSBrt and SBSCol.



# Multistandard Picture-In-Picture (PIP) controller

SAB9079HS

Table 17 border and colour settings

SUB ADDRESS	DATA BYTES							
	BIT 7	BIT 6	BIT 5	BIT 4	BIT 3	BIT 2	BIT 1	BIT 0
30H	BHSize <sub>(3:0)</sub>				BVSize <sub>(3:0)</sub>			
31H	–	SBON	SBBrt <sub>(1:0)</sub>		–	SBCol <sub>(2:0)</sub>		
32H	–	SBSON	SBSBrt <sub>(1:0)</sub>		–	SBSCol <sub>(2:0)</sub>		
33H	–	MBON	MBBrt <sub>(1:0)</sub>		–	MBCol <sub>(2:0)</sub>		
34H	FBLON	BGON	BGBrt <sub>(1:0)</sub>		–	BGCol <sub>(2:0)</sub>		
35H	OUVPol	OSDON	OSDBrt <sub>(1:0)</sub>		–	OSDCol <sub>(2:0)</sub>		
36H	Shade	OSDBLK	OSDSBrt <sub>(1:0)</sub>		–	OSDSCol <sub>(2:0)</sub>		
37H	–	–	–	–	SBSel <sub>(3:0)</sub>			

Table 18 Colour registers

COLOUR TYPE		BRIGHTNESS LEVELS			
COLOUR	VALUE	0H	1H	2H	3H
White (low)	0H	0%	10%	30%	50%
Blue	1H	30%	50%	70%	100%
Red	2H	30%	50%	70%	100%
Magenta	3H	30%	50%	70%	100%
Green	4H	30%	50%	70%	100%
Cyan	5H	30%	50%	70%	100%
Yellow	6H	30%	50%	70%	100%
White (high)	7H	60%	70%	80%	100%

## OSD CONTROLS

OSD can be placed on the screen in 4 rows of 4 strings. Each string can hold up to 6 characters. They can be placed on top of the sub PIPs. Fine positioning is done with the OSDHfp and OSDVfp bits. The OSDHDis bits determine the distance between the strings and OSDVdis determine the distance between the rows (see Table 19).

### OSDHfp and OSDVfp

Bits OSDHfp and OSDVfp control the fine positioning of the OSD text in steps of 4 pixels and 1 line.

### OSDHDis and OSDVDis

Bit OSDHDis determines the distance between the strings (in steps of 4 pixels) and bit OSDVdis determines the distance between the rows (in steps of 1 line).

## OSDEXP

It is possible to expand the OSD characters. 0xH is standard, 10H doubles the size and 11H quadruples the size.

### OSDBG and OSDTR

Bit OSDBG sets the OSD background. Bit OSDTR sets the transparency of the OSD background; the options are given in Table 20.

### OSDHRep and OSDVRep

Bit OSDHRep (see Table 21) sets the actual number of strings per row (a maximum of 4). Bit OSDVRep sets the actual number of rows (a maximum of 4).

# Multistandard Picture-In-Picture (PIP) controller

SAB9079HS

**Table 19** OSD control registers

SUB ADDRESS	DATA BYTES							
	BIT 7	BIT 6	BIT 5	BIT 4	BIT 3	BIT 2	BIT 1	BIT 0
38H	OSDHfp(7:0)							
39H	OSDVfp(7:0)							
3AH	OSDHDis(7:0)							
3BH	OSDVDis(7:0)							
3CH	OSDEXP		OSDBG	OSDTR	OSDHRep(1:0)		OSDVRep(1:0)	

**Table 20** OSD background

MODE	OSDBG	OSDTR	NOTE
Only OSD	0	x	PIP (BG)
OSD with BG	1	0	30% white
Transparent	1	1	50% PIP/30% white

**Table 21** Row and string settings

OSDXRep VALUE	OSDHRep NR. OF STRINGS	OSDVRep NR. OF ROWS
00B	1	1
01B	2	2
10B	3	3
11B	4	4

## OSD CHARACTERS

The OSD characters can be written to I<sup>2</sup>C-bus sub address 80H and higher (see Table 22). The index OSDCHR<sub>pos,row,col</sub> indicates the character position in the string, the row number and the column number of the string.

**Table 22** OSD write register

SUB ADDRESS	DATA BYTES							
	BIT 7	BIT 6	BIT 5	BIT 4	BIT 3	BIT 2	BIT 1	BIT 0
80H	OSDChr <sub>0,0,0</sub>							
81H	OSDChr <sub>0,0,1</sub>							
82H	OSDChr <sub>0,0,2</sub>							
83H	OSDChr <sub>0,0,3</sub>							
84H	OSDChr <sub>0,1,0</sub>							
85H	OSDChr <sub>0,1,1</sub>							
86H	OSDChr <sub>0,1,2</sub>							
86H	OSDChr <sub>0,1,3</sub>							
DEH	OSDChr <sub>5,3,2</sub>							
DFH	OSDChr <sub>5,3,3</sub>							

# Multistandard Picture-In-Picture (PIP) controller

SAB9079HS

### OSDChr

The OSDChr byte is divided into groups. The lower 7 bits OSDChr<sub>(6:0)</sub> contain the character to be displayed according to the character ROM table. Bit 7 indicates whether the character is selected, e.g. to change the background of that character. Selecting the first character of a string selects the whole string; selecting any other character has no effect.

**Table 23** Character ROM table; see also Fig.8

UPPER 3 BITS	LOWER 4 BITS															
	0H	1H	2H	3H	4H	5H	6H	7H	8H	9H	AH	BH	CH	DH	EH	FH
0H																
1H				¾	⅔	⅙	¼	⅓	½	⅓						
2H		!	"	#	\$	%	&	'	(	)	*	+	,	-	.	/
3H	0	1	2	3	4	5	6	7	8	9	:	;	<	=	>	?
4H	@	A	B	C	D	E	F	G	H	I	J	K	L	M	N	O
5H	P	Q	R	S	T	U	V	W	X	Y	Z	[	\	]	^	_
6H	`	a	b	c	d	e	f	g	h	i	j	k	l	m	n	o
7H	p	q	r	s	t	u	v	w	x	y	z	{		}	~	

### Note

1. Rows 0H and 1H are not completely represented because of their graphical contents (e.g. a smiley).

Multistandard Picture-In-Picture (PIP)  
controller

SAB9079HS

UPPER 3 BITS	LOWER 4 BITS															
	0H	1H	2H	3H	4H	5H	6H	7H	8H	9H	AH	BH	CH	DH	EH	FH
0H																
1H				$\frac{3}{4}$	$\frac{2}{3}$	$\frac{1}{6}$	$\frac{1}{4}$	$\frac{1}{3}$	$\frac{1}{2}$	$\frac{1}{1}$	↑	↓	→	←	😊	😞
2H		!	"	#	\$	%	&	'	(	)	*	+	,	-	.	/
3H	0	1	2	3	4	5	6	7	8	9	:	;	<	=	>	?
4H	@	A	B	C	D	E	F	G	H	I	J	K	L	M	N	O
5H	P	Q	R	S	T	U	V	W	X	Y	Z	[	\	]	^	_
6H	'	a	b	c	d	e	f	g	h	i	j	k	l	m	n	o
7H	p	q	r	s	t	u	v	w	x	y	z	{		}	~	■

MGS828

Fig.8 OSD character set.

# Multistandard Picture-In-Picture (PIP) controller

SAB9079HS

## YUV TO RGB CONVERSION MATRIX SETTINGS

### RGBOn

RGBOn enables the YUV to RGB matrix.

### XXCoefn (all coefficients)

The YUV to RGB conversion matrix has the following 3 equations:

1.  $R = RYCoef \times Y_d + RUCoef \times 2 \times (U_d - 128) + RVCoef \times 2 \times (V_d - 128)$
2.  $G = GYCoef \times Y_d + GUCoef \times 2 \times (U_d - 128) + GVCoef \times 2 \times (V_d - 128)$
3.  $B = BYCoef \times Y_d + BUCoef \times 2 \times (U_d - 128) + BVCoef \times 2 \times (V_d - 128)$

In this equation  $Y_d$  is normalised for the range 0 to 255,  $U_d$  and  $V_d$  for the range  $-128$  to  $128$ . The UV coefficients are two's complement in the range  $-1 \leq coef < 1$ . The Y coefficients are positives in the range  $0 \leq coef < 2$ . For PAL pictures the coef1 values are used, for NTSC the coef2 values.

**Table 24** Conversion settings

SUB ADDRESS	DATA BYTES							
	BIT 7	BIT 6	BIT 5	BIT 4	BIT 3	BIT 2	BIT 1	BIT 0
2EH	DCha+	DCha-	RepAcq	RepDisp	RepCont	-	-	RGBOn
3DH	RYCoef1 <sub>(7:0)</sub>							
3EH	RUCoef1 <sub>(7:0)</sub>							
3FH	RVCoef1 <sub>(7:0)</sub>							
40H	GYCoef1 <sub>(7:0)</sub>							
41H	GUCoef1 <sub>(7:0)</sub>							
42H	GVCoef1 <sub>(7:0)</sub>							
43H	BYCoef1 <sub>(7:0)</sub>							
44H	BUCoef1 <sub>(7:0)</sub>							
45H	BVCoef1 <sub>(7:0)</sub>							
46H	RYCoef2 <sub>(7:0)</sub>							
47H	RUCoef2 <sub>(7:0)</sub>							
48H	RVCoef2 <sub>(7:0)</sub>							
49H	GYCoef2 <sub>(7:0)</sub>							
4AH	GUCoef2 <sub>(7:0)</sub>							
4BH	GVCoef2 <sub>(7:0)</sub>							
4CH	BYCoef2 <sub>(7:0)</sub>							
4DH	BUCoef2 <sub>(7:0)</sub>							
4EH	BVCoef2 <sub>(7:0)</sub>							

### Note

1. DCha+, DCha-, RepAcq, RepDisp and RepCont are used for replay settings. They are not related to the conversion matrix.

# Multistandard Picture-In-Picture (PIP) controller

SAB9079HS

**EXTRA DECODER SETTINGS**

*CIDel and CIPer*

XXCIDel sets the delay from the rising edge of the HSYNC/burstkey to the beginning of the internally generated clamp pulse for signal XX in steps of 1 pixel. XXCIPer sets the pulse width of the internally generated clamp pulse in steps of 1 pixel.

*FidPos*

Bit Fidpos defines the position of the field identification window. The purpose is to set it so that the incoming VSYNC is halfway up the window. This allows a spread of 1/4 line for the VSYNC (VCR and/or less sophisticated decoder types) in steps of 2 pixels.

*VGate*

XVGate disables the detection of a next VSYNC for a number of lines, after detecting an initial one in steps of 1 line.

*SmIPal*

If this bit is set to logic 1, the vertical acquisition and display window for PAL is decreased from 276 lines to 258 lines

*TGAct1, TGAct2, TColBar, TGenY, TGenU and TGenV*

For test purposes, a built-in colour bar/ramp generator is available which replaces the ADC digital output data. This test generator is enabled if TGAct1 and TGAct2 are both set to logic 1, and is disabled when TGAct2 is set to logic 0 (it is recommended to set TGAct1 to logic 1). The test pattern (common for main and sub channels) is set to colour bar if TColBar is set to logic 1 and set to a ramp if TColBar is set to logic 0. Both patterns start at a HSYNC pulse. By use of bit(s) TGenX (active logic 1) the Y, U and V of the pattern can be controlled independently.

**Table 25** Extra decoder settings

SUB ADDRESS	DATA BYTES							
	BIT 7	BIT 6	BIT 5	BIT 4	BIT 3	BIT 2	BIT 1	BIT 0
4FH	SYCIDel <sub>(7:0)</sub>							
50H	SUCIDel <sub>(7:0)</sub>							
51H	SVCIDel <sub>(7:0)</sub>							
52H	–	–	SYCIPer <sub>(5:0)</sub>					
53H	–	–	SUCIPer <sub>(5:0)</sub>					
54H	–	–	SVCIPer <sub>(5:0)</sub>					
55H	SFidPos <sub>(7:0)</sub>							
56H	–	–	SVGATE <sub>(5:0)</sub>					
57H	MYCIDel <sub>(7:0)</sub>							
58H	MUCIDel <sub>(7:0)</sub>							
59H	MVCIDel <sub>(7:0)</sub>							
5AH	–	–	MYCIPer <sub>(5:0)</sub>					
5BH	–	–	MUCIPer <sub>(5:0)</sub>					
5CH	–	–	MVCIPer <sub>(5:0)</sub>					
5DH	MFidPos <sub>(7:0)</sub>							
5EH	–	–	MVGATE <sub>(5:0)</sub>					
5FH	SmIPal	–	TGAct1	TGAct2	TColBar	TGenY	TGenU	TGenV

## Multistandard Picture-In-Picture (PIP) controller

SAB9079HS

### DACs

These are 8-bit DACs. The maximum output sample frequency is 28 MHz.

### Acquisition channel ADCs and clamping

The analog input signals are converted to digital signals by means of three ADCs. The resolution of the ADCs is 8-bit (DNL is 7-bit, INL is 6-bit) and the sampling is done at the system frequency of 14 MHz. The inputs should be AC-coupled and an internal clamp circuit will clamp the input to  $V_{\text{ref(B)}(\text{SA/MA})}$  for the luminance channels and to

$$\frac{V_{\text{ref(T)}(\text{SA/MA})} + V_{\text{ref(B)}(\text{SA/MA})}{2} + \frac{\text{LSB}}{2}$$

for the chrominance channels.

The clamping starts at the active edge of the internally generated clamp period signal. The clamp period signal, generated from the HSYNC pulse, has a delay adjusted with the XXCICel bits with respect to the HSYNC. Internal video buffers amplify the standard input signals Y\*, U and V to the correct ADC levels. The bandwidth of the input signals should be limited to 4.5 MHz for the Y input and 1.125 MHz for the U and V inputs.

### PLL

The PLL generates, from the HSYNC, an internal system clock of 3584 HSYNC which is approximately 56 MHz. The other system clocks are derived from this clock. They are in the range 3584, 1792, 896 or  $448 \times \text{HSYNC}$ .

### LIMITING VALUES

In accordance with the Absolute Maximum Rating System (IEC 134).

SYMBOL	PARAMETER	CONDITIONS	MIN.	MAX.	UNIT
$V_{\text{DDD(P)}}$	digital supply voltage for the peripheral		-0.5	+6.0	V
$V_{\text{DDD(C)}}$	digital supply voltage for the core		-0.5	+4.0	V
$V_{\text{DDA}}$	analog supply voltage		-0.5	+4.0	V
$P_{\text{max}}$	maximum power dissipation		-	1.5	W
$T_{\text{stg}}$	storage temperature		-25	+150	°C
$T_{\text{amb}}$	ambient temperature		0	70	°C
$V_{\text{ESD}}$	electrostatic handling	note 1	-	3000	V
		note 2	-	300	V

### Notes

- Human body model; see "UZW-B0/FQ-B302".
- Machine model; see "UZW-B0/FQ-A302".

### QUALITY SPECIFICATION

According to "SNW-FQ-611 Part E", dated 14 december 1992. The numbers of the quality specification can be found in the "Quality Reference Handbook". The handbook can be ordered using the code 9397 750 00192.

### THERMAL CHARACTERISTICS

SYMBOL	PARAMETER	CONDITIONS	VALUE	UNIT
$R_{\text{th(j-a)}}$	thermal resistance from junction to ambient	in free air	37	K/W

# Multistandard Picture-In-Picture (PIP) controller

SAB9079HS

## ANALOG CHARACTERISTICS

 $V_{DD(P)} = 5.0\text{ V}$ ;  $V_{DD(C)} = 3.3\text{ V}$ ;  $T_{amb} = 25\text{ °C}$ ; unless otherwise specified.

SYMBOL	PARAMETER	CONDITIONS	MIN.	TYPE	MAX.	UNIT
<b>Supplies</b>						
$V_{DD(P)n}$	all digital supply voltages for the peripheral		4.5	5.0	5.5	V
$V_{DD(C)n}$	all digital supply voltages for the core		3.0	3.3	3.6	V
$V_{DDA}$	analog supply voltages		3.0	3.3	3.6	V
$V_{SS(n)}$	all ground voltages		–	0	–	V
$\Delta V_{DD(max)}$	maximum difference between supply voltages		–	0	100	mV
$\Delta V_{SS(max)}$	maximum difference between ground voltages		–	0	100	mV
$I_{DDD(q)}$	quiescent current of digital supply voltages	note 1	–	0	50	$\mu\text{A}$
$I_{VDDA(MP)}$	main PLL analog supply current		–	0.4	–	mA
$I_{VDDA(SP)}$	sub PLL analog supply current		–	0.4	–	mA
$I_{VDDA(MA)}$	main ADCs supply current	note 2	–	78	96	mA
$I_{VDDA(SA)}$	sub ADCs supply current	note 2	–	78	96	mA
$I_{VDDA(DA)}$	DACs supply current	note 3	–	10	17	mA
$I_{DDA(tot)}$	total analog supply current		–	170	210	mA
$I_{DDD(tot)}$	total digital supply current		–	115	–	mA
<b>Analog-to-digital converter and clamping</b>						
$V_{Vref(T)(SA/MA)}$	top reference voltage	note 4	2.65	2.82	2.95	V
$V_{Vref(B)(SA/MA)}$	bottom reference voltage	note 4	0.95	1.08	1.20	V
$V_{iY(p-p)}$	input signal amplitude (peak-to-peak value)	note 5	–	1.00	1.04	V
$V_{iV(p-p)}$	input signal amplitude (peak-to-peak value)	note 5	–	1.05	1.10	V
$V_{iU(p-p)}$	input signal amplitude (peak-to-peak value)	note 5	–	1.33	1.38	V
$I_i$	input current	clamping off	–	0.1	–	$\mu\text{A}$
		clamping on; note 2	–	55	–	$\mu\text{A}$
$C_i$	input capacitance		–	5	–	pF
$f_s$	sample frequency	note 6	–	896xHSYNC	–	kHz
RES	resolution	note 2	8	8	8	bit
DNL	differential non-linearity	note 2	–1.4	–	+1.4	LSB
INL	integral non-linearity	note 2	–2.0	–	+2.0	LSB
$\alpha_{cs}$	channel separation		–	48	–	dB
PSRR	power supply rejection ratio		–	48	–	dB



# Multistandard Picture-In-Picture (PIP) controller

SAB9079HS

SYMBOL	PARAMETER	CONDITIONS	MIN.	TYPE	MAX.	UNIT
$V_{\text{clamp}(Y)}$	clamping voltage level Y	note 7	1.25	1.35	1.45	V
$V_{\text{clamp}(UV)}$	clamping voltage level UV	note 8	1.80	1.95	2.10	V
<b>Digital-to-analog converter and output stage</b>						
$V_{\text{Vref}(T)(DA)}$	top reference voltage		1.10	1.20	1.30	V
$V_{\text{Vref}(B)(DA)}$	bottom reference voltage		0.15	0.22	0.30	V
$R_L$	load resistance		1	–	1000	k $\Omega$
$C_L$	load capacitance		0	–	50	pF
$f_s$	sample frequency	1FH; note 6	–	1792HSYNC	–	kHz
		2FH; note 6	–	896HSYNC	–	kHz
RES	resolution		8	8	8	bit
DNL	differential non-linearity	note 3	–1.0	–	+1.0	LSB
INL	integral non-linearity	note 3	–1.0	–	+1.0	LSB
$\alpha_{cs}$	channel separation	note 3	–	48	–	dB
PSRR	power supply rejection ratio	note 3	–	48	–	dB
<b>Main PLL and clock generation</b>						
$f_{i(PLL)(\text{main})}$	input frequency 1FH	note 6	14	15.75	18	kHz
<b>Sub PLL and clock generation</b>						
$f_{i(PLL)(\text{sub})}$	input frequency	note 6	14	15.75	18	kHz

## Notes

1. Digital clocks are silent, POR connected to  $V_{DD}$ .
2. Load resistance of  $V_{\text{bias}(MA)}/V_{\text{bias}(SA)}$  is 39 k $\Omega$ .
3. The load resistance of DAC outputs is 1 k $\Omega$ .
4. The  $V_{\text{Vref}(T)(SA/MA)}$  and  $V_{\text{Vref}(B)(SA/MA)}$  are made by a resistor division of  $V_{DDA}$ . They can be calculated with the formulae:

$$a) V_{\text{Vref}(T)(SA/MA)} = V_{DDA} \times \frac{2V_{\text{ref}(T)(\text{nom})}}{V_{DDA(\text{nom})}} \text{ V}$$

$$b) V_{\text{Vref}(B)(SA/MA)} = V_{DDA} \times \frac{V_{\text{ref}(B)(\text{nom})}}{V_{DDA(\text{nom})}} \text{ V}$$

5. The input signal is amplified to meet an internal peak-to-peak voltage level of  $V_{\text{Vref}(T)(SA/MA)} - V_{\text{Vref}(B)(SA/MA)}$ .
6. The internal system frequencies are 3584, 1792, 896 and 448 times the HSYNC input frequency.
7. The Y\* channel is clamped to the  $V_{\text{Vref}(B)(SA/MA)}$  of the ADCs, which is derived from pin  $V_{\text{ref}(B)(SA)}$  and pin  $V_{\text{ref}(B)(MA)}$ .
8. The UV channels are clamped to  $0.5 \times (V_{\text{Vref}(T)(SA/MA)} + V_{\text{Vref}(B)(SA/MA)} + V_{\text{LSB}})$ . Where  $V_{\text{LSB}}$  is one step of the ADC.

# Multistandard Picture-In-Picture (PIP) controller

SAB9079HS

## COLOUR PATH CHARACTERISTICS

SYMBOL	PARAMETER	CONDITIONS	MIN.	TYP.	MAX.	UNIT
$G_{(conv)(MY)}$	analog Y* input ADC conversion gain for main channel		0.20	0.22	0.24	LSB/mV
$G_{(conv)(SY)}$	analog Y* input ADC conversion gain for sub channel		0.20	0.22	0.24	LSB/mV
$G_{(conv)(MU)}$	analog U input ADC conversion gain for main channel		0.15	0.17	0.19	LSB/mV
$G_{(conv)(SU)}$	analog U input ADC conversion gain for sub channel		0.15	0.17	0.19	LSB/mV
$G_{(conv)(MV)}$	analog V input ADC conversion gain for main channel		0.19	0.21	0.23	LSB/mV
$G_{(conv)(SV)}$	analog V input ADC conversion gain for sub channel		0.19	0.21	0.23	LSB/mV
$G_{(conv)(DY)}$	analog Y output ADC conversion gain		6.0	6.8	7.5	LSB/mV
$G_{(conv)(DU)}$	analog U output ADC conversion gain		6.0	6.8	7.5	LSB/mV
$G_{(conv)(DV)}$	analog V output ADC conversion gain		6.0	6.8	7.5	LSB/mV
$MM_{ADC(Y)}$	analog Y ADC mismatch	note 1	–	0	5	%
$MM_{ADC(U)}$	analog U ADC mismatch	note 1	–	0	5	%
$MM_{ADC(V)}$	analog V ADC mismatch	note 1	–	0	5	%
$MM_{ADC(YUV)}$	analog YUV ADC mismatch	note 1	–	0	5	%

### Note

1. Mismatch = (max – min)/average.

# Multistandard Picture-In-Picture (PIP) controller

SAB9079HS

## DIGITAL CHARACTERISTICS

All  $V_{DD(DC)}$  pins = 3.0 to 3.6 V;  $T_{amb}$  = 0 to 70 °C; unless otherwise specified.

SYMBOL	PARAMETER	CONDITIONS	MIN.	TYPE	MAX.	UNIT
<b>DC characteristics</b>						
$V_{IH}$	HIGH-level input voltage		70	–	–	% $V_{DDD}$
$V_{IL}$	LOW-level input voltage		–	–	30	% $V_{DDD}$
$V_{hys}$	hysteresis voltage		–	30	–	% $V_{DDD}$
$V_{OH}$	HIGH-level output voltage		$V_{DDD(P)} - 0.4$	–	–	V
$V_{OL}$	LOW-level output voltage		–	–	0.4	V
$ I_{LI} $	input leakage current	$V_{DDD} = 3.6\text{ V}$	–	0.1	1	$\mu\text{A}$
$ I_{OZ} $	3-state input leakage current	$V_{DDD} = 3.6\text{ V}$	–	0.2	1	$\mu\text{A}$
$R_{pu}$	internal pull-up resistor		23	50	80	$\text{k}\Omega$
<b>AC characteristics</b>						
$f_{sys}$	system frequency	note 1	–	3584xHSYNC		kHz
$t_r$	rise time		–	6	25	ns
$t_f$	fall time		–	6	25	ns

### Note

- The internal system frequencies are 3584, 1792, 896 and 448 times the HSYNC input frequency.

## TEST AND APPLICATION INFORMATION

### TV application with insertion before 100 Hz feature box (double window)

In the 100 Hz application the deflection circuit operates at 100 Hz. The PIP data is inserted into the main decoder output stream and fed to the feature box. The double window feature is made at 1Fh and the field rate is doubled in the feature box. The internal synchronization is illustrated in Fig.9.

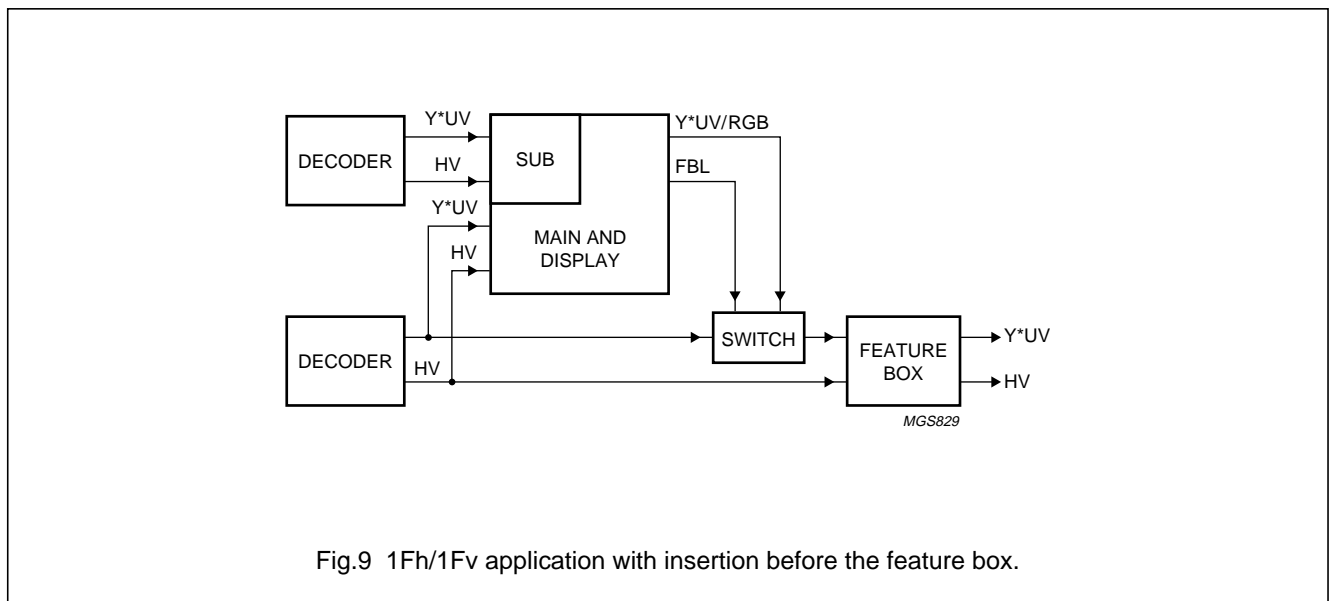

Fig.9 1Fh/1Fv application with insertion before the feature box.

## Multistandard Picture-In-Picture (PIP) controller

SAB9079HS

### SLAVE 2FH GENERAL DESCRIPTION

In the slave mode the main and display channel has to follow an external 2Fh, xFv signal. The main acquisition cannot handle such a source, the main/display PLL can. Thus no main channel PIP is available, only the upconverted sub channel can be inserted. The following functions are available in 4 : 1 : 1 only unless otherwise indicated:

- Suitable for single PIP, multi PIP, replay and channel overview applications
- Data formats 4 : 1 : 1 (all modes) and 4 : 2 : 2 (some modes)
- PIP OSD for the sub channels displayed
- Detection of PAL/NTSC with overrule bit

- CTE and LTE like circuits in display part
- Replay with definable auto increment, picture sample rate and picture number auto wrap
- Programmable Y\*UV to RGB conversion matrix with independent coefficients for NTSC and PAL sources
- Display clock and synchronization are derived from the main channel PLL.

The following features are only available for the sub channel:

- Sample rate of 14 Mhz, 720 Y\* pixels/line
- Horizontal reduction factors  $\frac{1}{1}$ ,  $\frac{1}{2}$ ,  $\frac{1}{3}$ ,  $\frac{1}{4}$  and  $\frac{1}{6}$
- Vertical reduction factors  $\frac{1}{1}$ ,  $\frac{1}{2}$ ,  $\frac{1}{3}$  and  $\frac{1}{4}$ .

### 2FH, 1FV ALGORITHMS

**Table 26** Available 2Fh and 1Fv algorithms

ALGORITHM	FORMAT 4 : 1 : 1	FORMAT 4 : 2 : 2	REMARKS
progressive scan	yes	no; note 1	proscan (median filtering)
line doubling	yes	yes	note 2

### Notes

1. Median filtering in 4 : 2 : 2 mode is allowed for single PIP (no main channel) and reduction factors not greater than  $\frac{1}{2}$  for both horizontal and vertical
2. The performance of the line doubling algorithm is dependent on the picture content. Line (based interlace) flickering will remain in this mode.

### 2FH, 2FV ALGORITHMS

**Table 27** Available 2Fh and 2Fv algorithms

ALGORITHM	FORMAT 4 : 1 : 1	FORMAT 4 : 2 : 2	REMARKS
AABB field doubling	yes	yes	
ABAB field doubling	yes	yes	
AB'A'B fields interpolation via median filtering	yes	no; note 1	digital scan
AB'A'B+ field interpolation via median filtering and averaging with original fields	yes	no; note 1	digital scan plus

### Note

1. Median filtering in 4 : 2 : 2 mode is allowed for single PIP (no main channel) and reduction factors not greater than  $\frac{1}{2}$  for both horizontal and vertical

# Multistandard Picture-In-Picture (PIP) controller

SAB9079HS

## SLAVE 2FH AND XFV RELATED I<sup>2</sup>C-BUS REGISTERS

**Table 28** Overview of the I<sup>2</sup>C-bus registers and their subaddresses

SUB ADDRESS	DATA BYTES							
	BIT 7	BIT 6	BIT 5	BIT 4	BIT 3	BIT 2	BIT 1	BIT 0
01H	D2FH	D2FV	–	–	MFld <sub>(1:0)</sub>		SFld <sub>(1:0)</sub>	
02H	YUVFilter <sub>(1:0)</sub>		ABMode <sub>(1:0)</sub>		CTE	LTE <sub>(2:0)</sub>		

### D2FH and D2FV

These bits control the display mode with respect to 2Fh or 100 Hz features. If D2FH is set to logic 1 the number of lines is doubled and/or if D2FV is set to logic 1 the number of fields is doubled.

### ABMode

These bits select the different algorithms for 2Fh modes; see Table 29.

### Algorithm selection

Several display algorithms can be set with these bits; an overview is given in Table 29.

### Note: BGVfp

The resolution of the MAVfp bits changes in 2Fh and xFv modes. In 2Fh and 1Fv modes the vertical resolution is 2 lines/field/step on 1Fh base. In 2Fh and 2Fv modes the vertical resolution is 2 lines/field/step on 2Fh base.

**Table 29** Overview of algorithm selection

MODE	D2FH	YUVFilter	D2FV	ABMode
No filter	0	00H	–	00H
UV 1 : 1 V filter	0	01H	0	00H
Y 1 : 1 V filter	0	10H	0	00H
YUV 1 : 1 V filter	0	11H	0	00H
2FH/1FV frame	1	xxH	0	00H
2FH/1FV proscan	1	xxH	0	01H
2FH/1FV line doubling	1	xxH	0	10H
not valid	1	xxH	0	11H
2FH/2FV AABB	1	00H	1	00H
2FH/2FV ABAB	1	00H	1	01H
2FH/2FV AB'A'B	1	00H	1	10H
2FH/2FV AB'A'B+	1	00H	1	11H

# Multistandard Picture-In-Picture (PIP) controller

SAB9079HS

## SLAVE 2FH MEMORY REQUIREMENTS

In the slave 2Fh modes only the sub picture can be present. The following conditions must be met:

- When vertical reduction is 1, the field mode can be set to 3
- When vertical reduction is not equal to 1, the field mode must be set to 4
- When no live picture is present, such as replay or channel overview, the field mode can be set to 1.

Under these conditions a maximum number of stored fields/pictures can be determined. Combined with the size of one picture, the total amount needed can be calculated always supposing that 1 PIP is live.

A selected overview is given in Table 30. The VDRAM size is 262144 words of 16 bits

**Table 30** Memory requirements for 2Fh slave

MODE	PICTURES STORED	PICTURE SIZE NTSC (WORDS)	TOTAL NTSC	PICTURE SIZE PAL (WORDS)	TOTAL PAL
2 × V1_H2	4	46284	185136	56028	224112
4 × V2_H2	7	23142	161994	28014	196098
6 × V2_H3	9	15390	138510	18630	167670
9 × V3_H3	12	10260	123120	12420	149040
12 × V4_H3	15	7695	115425	9315	139725
16 × V4_H4	19	5928	112632	7176	136344

## SLAVE 2FH DESIGN RESTRICTIONS

The design has margins for a 2Fh frequency of 31.5 kHz. Applying a SVGA source with a horizontal frequency of 38 kHz will stress the SAB9079HS. Therefore, a SVGA source can only be applied under the following restricted conditions:

- Power supply spread of 5% instead of 10%
- No VCR like phase jump in 2Fh signal.

**Table 31** Design characteristics

SYMBOL	PARAMETER	CONDITIONS	MIN.	TYP.	MAX.	UNIT
<b>Supplies</b>						
V <sub>DD(P)</sub>	all digital supply voltages for periphery		4.75	5.0	5.25	V
V <sub>DD(C)</sub>	all digital supply voltages for core		3.15	3.3	3.6	V
V <sub>DDA</sub>	all analog supply voltages		3.15	3.3	3.6	V
V <sub>SS</sub>	all ground voltages		–	0	–	V
<b>Main PLL and clock generation</b>						
f <sub>i(PLL)</sub>		note 1	28	31.50	36	kHz
		note 2	–	–	60	kHz

### Note

1. The PLL will lock within 20 lines to instable sources with a large phase jump if the frequency is within the range 28 to 36 kHz.
2. The PLL will lock to stable 2Fh sources with a maximum frequency of 60 kHz.

# Multistandard Picture-In-Picture (PIP) controller

SAB9079HS

## TV APPLICATION WITH INSERTION AFTER 100 HZ (SLAVE)

In this application there is no relationship between the deflection and acquisition circuits. A double window feature can be realized by letting the feature box compress one window and make the second window by the SAB9079HS. In this application the HVSYNC of the feature box/line doubler is connected to the main acquisition HVSYNC. The restriction is that no main PIPs can be displayed. The application diagram is illustrated in Fig.10.

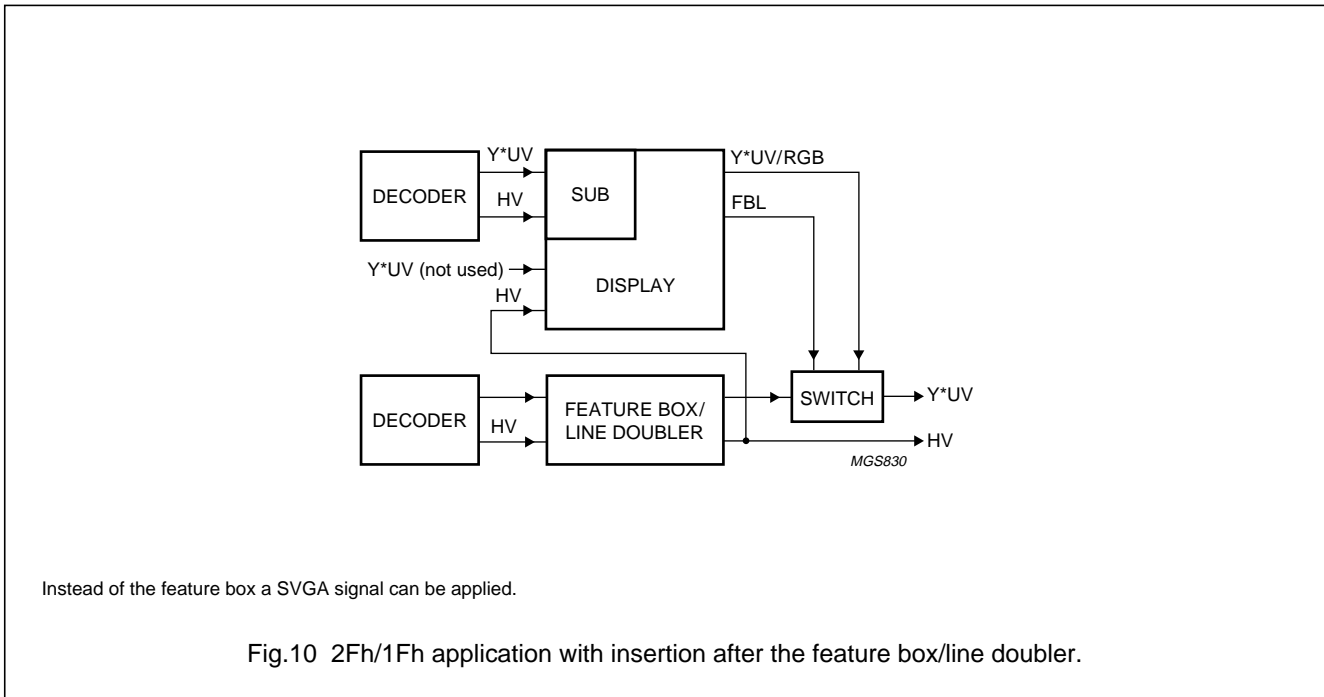

## Multistandard Picture-In-Picture (PIP) controller

SAB9079HS

### Master 2Fh general description

A 1Fh, 1Fv signal at the acquisition side can be upconverted to a 2Fh, 1Fv or a 2Fh, 2Fv signal. The restriction is that both acquisition channels will be upconverted at the same time. Therefore, the main channel displayed as 1Fh, 1Fv combined with a sub channel displayed as 2Fh, 1Fv is not possible. In the master mode the SAB9079HS generates the HSYNC and VSYNC for display/deflection. There is no protection built in. HSYNC and VSYNC cannot be coupled directly to a tube. A deflection IC should be applied. Both main and sub pictures can be acquired/displayed. The following functions are available:

- Suitable for single PIP, some multi PIP modes, replay and channel overview applications
- Data formats 4 : 1 : 1 (all modes) and 4 : 2 : 2 (some modes)
- Sample rate of 14 Mhz, 720 Y\* pixels/line
- Horizontal reduction factors for main channel  $\frac{1}{4}$ ,  $\frac{3}{4}$ ,  $\frac{2}{3}$ ,  $\frac{1}{2}$ ,  $\frac{1}{3}$ ,  $\frac{1}{4}$  and  $\frac{1}{6}$
- Horizontal reduction factors for sub channel  $\frac{1}{4}$ ,  $\frac{3}{4}$ ,  $\frac{2}{3}$ ,  $\frac{1}{2}$ ,  $\frac{1}{3}$ ,  $\frac{1}{4}$  and  $\frac{1}{6}$
- Vertical reduction factors  $\frac{1}{4}$ ,  $\frac{1}{2}$ ,  $\frac{1}{3}$  and  $\frac{1}{4}$ .
- PIP OSD for the sub channels displayed
- Detection of PAL/NTSC with overrule bit
- CTE and LTE like circuits in display mode
- Replay with definable auto increment, picture sample rate and picture number auto wrap
- Programmable Y\*UV to RGB conversion matrix with independent coefficients for NTSC and PAL sources
- Display clock and synchronization are derived from the main channel PLL.

### 2Fh, 1Fv ALGORITHMS

**Table 32** Available 2Fh and 1Fv algorithms

ALGORITHM	FORMAT 4 : 1 : 1	FORMAT 4 : 2 : 2	REMARKS
progressive scan	yes	no; note 1	proscan (median filtering)
line doubling	yes	yes	note 2

### Notes

1. Median filtering in 4 : 2 : 2 mode is allowed for single PIP (no main channel) and reduction factors not greater than  $\frac{1}{2}$  for both horizontal and vertical
2. The performance of the line doubling algorithm is dependent on the picture content. Line (based interlace) flickering will remain in this mode.

### 2Fh, 2Fv ALGORITHMS

**Table 33** Available 2Fh and 2Fv algorithms

ALGORITHM	FORMAT 4 : 1 : 1	FORMAT 4 : 2 : 2	REMARKS
AABB field doubling	yes	yes	
ABAB field doubling	yes	yes	
AB'A'B fields interpolation via median filtering	yes	no; note 1	digital scan
AB'A'B+ field interpolation via median filtering and averaging with original fields	yes	no; note 1	digital scan plus

### Note

1. Median filtering in 4 : 2 : 2 mode is allowed for single PIP (no main channel) and reduction factors not greater than  $\frac{1}{2}$  for both horizontal and vertical



# Multistandard Picture-In-Picture (PIP) controller

SAB9079HS

## MASTER 2FH AND xFV RELATED I<sup>2</sup>C-BUS REGISTERS

**Table 34** Overview of the I<sup>2</sup>C-bus registers and their subaddresses

SUB ADDRESS	DATA BYTES							
	BIT 7	BIT 6	BIT 5	BIT 4	BIT 3	BIT 2	BIT 1	BIT 0
01H	D2FH	D2FV	DMaster	DVSPos	MFld <sub>(1:0)</sub>		SFld <sub>(1:0)</sub>	
02H	YUVFilter <sub>(1:0)</sub>		ABMode <sub>(1:0)</sub>		CTE	LTE <sub>(2:0)</sub>		
26H	–	–	–	HSWidth				
27H	–	–	VSDel					
28H	–	–	–	VSWidth				

### *D2FH, D2FV, DMaster and DVSPos*

These bits control the display mode with respect to 2Fh or 100 Hz features. If D2FH is set to logic 1 the number of lines is doubled and/or if D2FV is set to logic 1 the number of fields is doubled.

If DMaster is at logic 0 the device is in slave mode. DHSYNC and DVSYNC should not be used. If DMaster is at logic 1 the device is in master mode which means that HV synchronization signals are generated. They are derived from MHSYNC and MVSYNC. The DHSYNC and DVSYNC output signals should be used as sync signals for the deflection IC.

DVSPos is only valid if DMaster is set to logic 1. If DVSPos is set to logic 0 the VSYNC pulses are generated with an alternating field ID according to the ABAB algorithm. If DVSPos is set to logic 1 the VSYNC pulses are generated in the AABB scheme which means that two first fields are alternated with two second fields.

### *ABMode*

These bits select the different algorithms for 2Fh modes; see Table 35.

### *HSWidth*

The width of the DHSYNC can be set in the master mode. The width is from 0 to 31 pixels and the resolution is one 2Fh pixel.

### *VSWidth*

The width of the DVSYNC can be set in the master mode. The scale is from 0 to 31 lines on a 2Fh base and the resolution is  $\frac{1}{2}$  2Fh.

### *VSDel*

The position of the DVSYNC, with respect to the incoming MVSYNC, can be set in the master mode. The delay is a 6-bit value and the steps are from 0 to 63 lines on a 2Fh base and the resolution is  $\frac{1}{2}$  2Fh line.

### *Algorithm selection*

Several display algorithms can be set with these bits; an overview is given in Table 35.

### **Note:** BGVfp

The resolution of the BGVfp bits changes in 2Fh and xFv modes. In 2Fh and 1Fv modes the vertical resolution is 2 lines/field/step on 1Fh base. In 2Fh and 2Fv modes the vertical resolution is 2 lines/field/step on 2Fh base.

## Multistandard Picture-In-Picture (PIP) controller

SAB9079HS

**Table 35** Overview of algorithm selection

MODE	D2FH	YUVFilter	D2FV	ABMode
No filter	0	00H	–	00H
UV 1 : 1 V filter	0	01H	0	00H
Y 1 : 1 V filter	0	10H	0	00H
YUV 1 : 1 V filter	0	11H	0	00H
2FH/1FV frame	1	xxH	0	00H
2FH/1FV proscan	1	xxH	0	01H
2FH/1FV line doubling	1	xxH	0	10H
not valid	1	xxH	0	11H
2FH/2FV AABB	1	00H	1	00H
2FH/2FV ABAB	1	00H	1	01H
2FH/2FV AB'A'B	1	00H	1	10H
2FH/2FV AB'A'B+	1	00H	1	11H

**FIELD MODE SETTINGS**

In the master mode signals will be synchronized to the main 1Fh, 1Fv input signal. This eases the restrictions on the number of fields to be stored for the scan converted main picture. Conditions to be met for a live picture are given in Table 36.

**Table 36** Master 2Fh field mode settings

VERTICAL REDUCTION	FIELDS FOR MAIN CHANNEL	FIELDS FOR SUB CHANNEL	REMARKS
1/1	2	3	except for horizontal reduction 1/1
other modes	4	4	–

# Multistandard Picture-In-Picture (PIP) controller

## SAB9079HS

### FEATURE BOX APPLICATION 100 HZ (MASTER)

In this mode the SAB9079HS generates the display clock which is derived from the main clock and synchronization signals. The whole system runs at one PLL. Only full screen images of the main decoder are handled. The PIP insertion of the sub channel is not required here; see Fig.11.

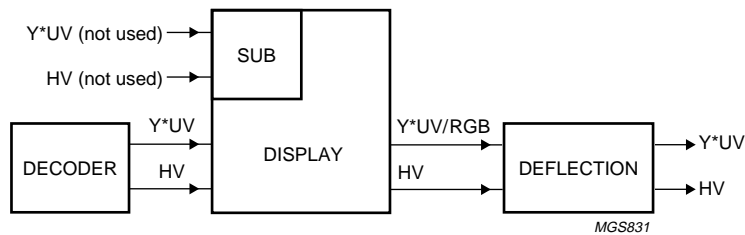

Fig.11 100 Hz application with ECO-100 Hz function.

### DOUBLE WINDOW AND/OR OTHER PIP FUNCTIONS AT 100 HZ (MASTER)

This is the same configuration as Fig.11 but the sub channel is also needed and, therefore, a second PLL. The constraints apply with respect to the memory use and performance. Double window PAL is only possible if bit SmIPal is set to logic 1, this is due to the memory limitations.

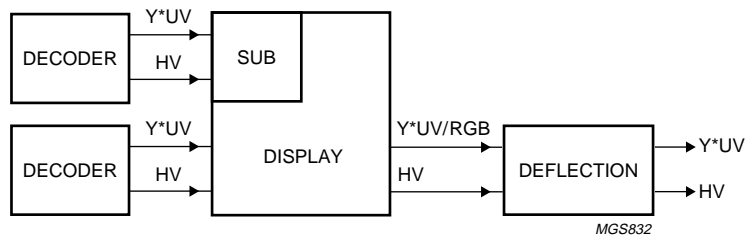

Fig.12 100 Hz application with 2 channel PIP function.

### DOUBLE WINDOW AND/OR OTHER PIP FUNCTIONS AT 2FH, 1FV (MASTER)

For the application diagram please refer to Fig.12.

# Multistandard Picture-In-Picture (PIP) controller

## SAB9079HS

### PACKAGE OUTLINE

**SQFP128: plastic shrink quad flat package;**  
**128 leads (lead length 1.6 mm); body 14 x 20 x 2.72 mm**

**SOT387-3**

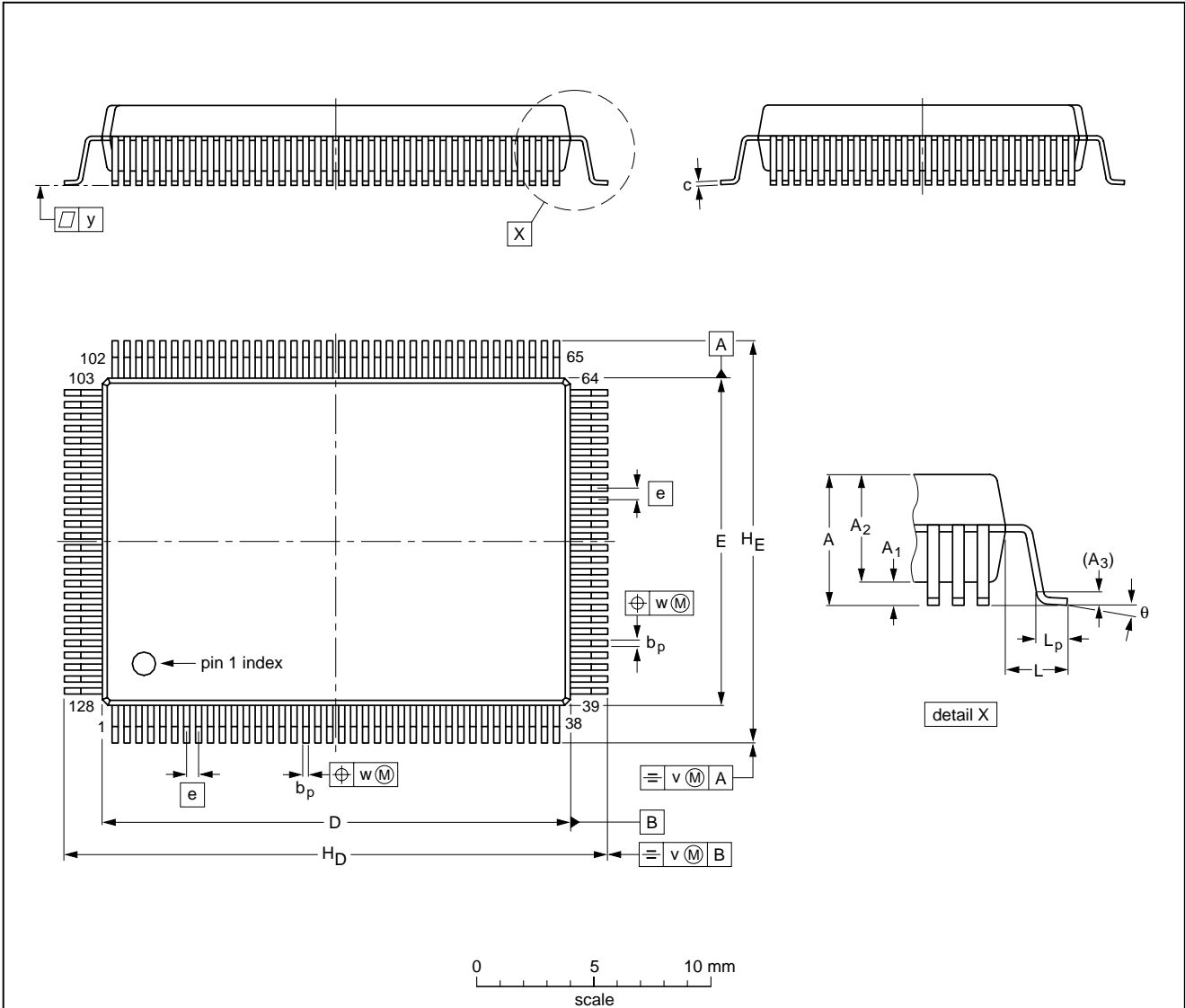

**DIMENSIONS (mm are the original dimensions)**

UNIT	A max.	A <sub>1</sub> min.	A <sub>2</sub>	A <sub>3</sub>	b <sub>p</sub>	c	D <sup>(1)</sup>	E <sup>(1)</sup>	e	H <sub>D</sub>	H <sub>E</sub>	L	L <sub>p</sub>	v	w	y	θ
mm	3.40	0.25	2.90 2.50	0.25	0.27 0.17	0.23 0.11	20.1 19.9	14.1 13.9	0.50	23.35 23.05	17.35 17.05	1.60	1.03 0.73	0.20	0.08	0.08	7° 0°

**Note**

1. Plastic or metal protrusions of 0.25 mm maximum per side are not included.

OUTLINE VERSION	REFERENCES				EUROPEAN PROJECTION	ISSUE DATE
	IEC	JEDEC	EIAJ			
SOT387-3						98-03-27

## Multistandard Picture-In-Picture (PIP) controller

## SAB9079HS

### SOLDERING

#### Introduction to soldering surface mount packages

This text gives a very brief insight to a complex technology. A more in-depth account of soldering ICs can be found in our *"Data Handbook IC26; Integrated Circuit Packages"* (document order number 9398 652 90011).

There is no soldering method that is ideal for all surface mount IC packages. Wave soldering is not always suitable for surface mount ICs, or for printed-circuit boards with high population densities. In these situations reflow soldering is often used.

#### Reflow soldering

Reflow soldering requires solder paste (a suspension of fine solder particles, flux and binding agent) to be applied to the printed-circuit board by screen printing, stencilling or pressure-syringe dispensing before package placement.

Several methods exist for reflowing; for example, infrared/convection heating in a conveyor type oven. Throughput times (preheating, soldering and cooling) vary between 100 and 200 seconds depending on heating method.

Typical reflow peak temperatures range from 215 to 250 °C. The top-surface temperature of the packages should preferably be kept below 230 °C.

#### Wave soldering

Conventional single wave soldering is not recommended for surface mount devices (SMDs) or printed-circuit boards with a high component density, as solder bridging and non-wetting can present major problems.

To overcome these problems the double-wave soldering method was specifically developed.

If wave soldering is used the following conditions must be observed for optimal results:

- Use a double-wave soldering method comprising a turbulent wave with high upward pressure followed by a smooth laminar wave.
- For packages with leads on two sides and a pitch (e):
  - larger than or equal to 1.27 mm, the footprint longitudinal axis is **preferred** to be parallel to the transport direction of the printed-circuit board;
  - smaller than 1.27 mm, the footprint longitudinal axis **must** be parallel to the transport direction of the printed-circuit board.

The footprint must incorporate solder thieves at the downstream end.

- For packages with leads on four sides, the footprint must be placed at a 45° angle to the transport direction of the printed-circuit board. The footprint must incorporate solder thieves downstream and at the side corners.

During placement and before soldering, the package must be fixed with a droplet of adhesive. The adhesive can be applied by screen printing, pin transfer or syringe dispensing. The package can be soldered after the adhesive is cured.

Typical dwell time is 4 seconds at 250 °C.

A mildly-activated flux will eliminate the need for removal of corrosive residues in most applications.

#### Manual soldering

Fix the component by first soldering two diagonally-opposite end leads. Use a low voltage (24 V or less) soldering iron applied to the flat part of the lead. Contact time must be limited to 10 seconds at up to 300 °C.

When using a dedicated tool, all other leads can be soldered in one operation within 2 to 5 seconds between 270 and 320 °C.

# Multistandard Picture-In-Picture (PIP) controller

SAB9079HS

## Suitability of surface mount IC packages for wave and reflow soldering methods

PACKAGE	SOLDERING METHOD	
	WAVE	REFLOW <sup>(1)</sup>
BGA, SQFP	not suitable	suitable
HLQFP, HSQFP, HSOP, HTSSOP, SMS	not suitable <sup>(2)</sup>	suitable
PLCC <sup>(3)</sup> , SO, SOJ	suitable	suitable
LQFP, QFP, TQFP	not recommended <sup>(3)(4)</sup>	suitable
SSOP, TSSOP, VSO	not recommended <sup>(5)</sup>	suitable

### Notes

1. All surface mount (SMD) packages are moisture sensitive. Depending upon the moisture content, the maximum temperature (with respect to time) and body size of the package, there is a risk that internal or external package cracks may occur due to vaporization of the moisture in them (the so called popcorn effect). For details, refer to the Drypack information in the *"Data Handbook IC26; Integrated Circuit Packages; Section: Packing Methods"*.
2. These packages are not suitable for wave soldering as a solder joint between the printed-circuit board and heatsink (at bottom version) can not be achieved, and as solder may stick to the heatsink (on top version).
3. If wave soldering is considered, then the package must be placed at a 45° angle to the solder wave direction. The package footprint must incorporate solder thieves downstream and at the side corners.
4. Wave soldering is only suitable for LQFP, TQFP and QFP packages with a pitch (e) equal to or larger than 0.8 mm; it is definitely not suitable for packages with a pitch (e) equal to or smaller than 0.65 mm.
5. Wave soldering is only suitable for SSOP and TSSOP packages with a pitch (e) equal to or larger than 0.65 mm; it is definitely not suitable for packages with a pitch (e) equal to or smaller than 0.5 mm.

## Multistandard Picture-In-Picture (PIP) controller

SAB9079HS

### DEFINITIONS

<b>Data sheet status</b>	
Objective specification	This data sheet contains target or goal specifications for product development.
Preliminary specification	This data sheet contains preliminary data; supplementary data may be published later.
Product specification	This data sheet contains final product specifications.
<b>Limiting values</b>	
Limiting values given are in accordance with the Absolute Maximum Rating System (IEC 134). Stress above one or more of the limiting values may cause permanent damage to the device. These are stress ratings only and operation of the device at these or at any other conditions above those given in the Characteristics sections of the specification is not implied. Exposure to limiting values for extended periods may affect device reliability.	
<b>Application information</b>	
Where application information is given, it is advisory and does not form part of the specification.	

### LIFE SUPPORT APPLICATIONS

These products are not designed for use in life support appliances, devices, or systems where malfunction of these products can reasonably be expected to result in personal injury. Philips customers using or selling these products for use in such applications do so at their own risk and agree to fully indemnify Philips for any damages resulting from such improper use or sale.

### PURCHASE OF PHILIPS I<sup>2</sup>C COMPONENTS



Purchase of Philips I<sup>2</sup>C components conveys a license under the Philips' I<sup>2</sup>C patent to use the components in the I<sup>2</sup>C system provided the system conforms to the I<sup>2</sup>C specification defined by Philips. This specification can be ordered using the code 9398 393 40011.

# Philips Semiconductors – a worldwide company

**Argentina:** see South America

**Australia:** 3 Figtree Drive, HOMEBUSH, NSW 2140,  
Tel. +61 2 9704 8141, Fax. +61 2 9704 8139

**Austria:** Computerstr. 6, A-1101 WIEN, P.O. Box 213,  
Tel. +43 1 60 101 1248, Fax. +43 1 60 101 1210

**Belarus:** Hotel Minsk Business Center, Bld. 3, r. 1211, Volodarski Str. 6,  
220050 MINSK, Tel. +375 172 20 0733, Fax. +375 172 20 0773

**Belgium:** see The Netherlands

**Brazil:** see South America

**Bulgaria:** Philips Bulgaria Ltd., Energoproject, 15th floor,  
51 James Bourchier Blvd., 1407 SOFIA,  
Tel. +359 2 68 9211, Fax. +359 2 68 9102

**Canada:** PHILIPS SEMICONDUCTORS/COMPONENTS,  
Tel. +1 800 234 7381, Fax. +1 800 943 0087

**China/Hong Kong:** 501 Hong Kong Industrial Technology Centre,  
72 Tat Chee Avenue, Kowloon Tong, HONG KONG,  
Tel. +852 2319 7888, Fax. +852 2319 7700

**Colombia:** see South America

**Czech Republic:** see Austria

**Denmark:** Sydhavnsgade 23, 1780 COPENHAGEN V,  
Tel. +45 33 29 3333, Fax. +45 33 29 3905

**Finland:** Sinikalliontie 3, FIN-02630 ESPOO,  
Tel. +358 9 615 800, Fax. +358 9 6158 0920

**France:** 51 Rue Carnot, BP317, 92156 SURESNES Cedex,  
Tel. +33 1 4099 6161, Fax. +33 1 4099 6427

**Germany:** Hammerbrookstraße 69, D-20097 HAMBURG,  
Tel. +49 40 2353 60, Fax. +49 40 2353 6300

**Hungary:** see Austria

**India:** Philips INDIA Ltd, Band Box Building, 2nd floor,  
254-D, Dr. Annie Besant Road, Worli, MUMBAI 400 025,  
Tel. +91 22 493 8541, Fax. +91 22 493 0966

**Indonesia:** PT Philips Development Corporation, Semiconductors Division,  
Gedung Philips, Jl. Buncit Raya Kav.99-100, JAKARTA 12510,  
Tel. +62 21 794 0040 ext. 2501, Fax. +62 21 794 0080

**Ireland:** Newstead, Clonskeagh, DUBLIN 14,  
Tel. +353 1 7640 000, Fax. +353 1 7640 200

**Israel:** RAPAC Electronics, 7 Kehilat Saloniki St, PO Box 18053,  
TEL AVIV 61180, Tel. +972 3 645 0444, Fax. +972 3 649 1007

**Italy:** PHILIPS SEMICONDUCTORS, Via Casati, 23 - 20052 MONZA (MI),  
Tel. +39 039 203 6838, Fax +39 039 203 6800

**Japan:** Philips Bldg 13-37, Kohnan 2-chome, Minato-ku,  
TOKYO 108-8507, Tel. +81 3 3740 5130, Fax. +81 3 3740 5057

**Korea:** Philips House, 260-199 Itaewon-dong, Yongsan-ku, SEOUL,  
Tel. +82 2 709 1412, Fax. +82 2 709 1415

**Malaysia:** No. 76 Jalan Universiti, 46200 PETALING JAYA, SELANGOR,  
Tel. +60 3 750 5214, Fax. +60 3 757 4880

**Mexico:** 5900 Gateway East, Suite 200, EL PASO, TEXAS 79905,  
Tel. +9-5 800 234 7381, Fax +9-5 800 943 0087

**Middle East:** see Italy

**Netherlands:** Postbus 90050, 5600 PB EINDHOVEN, Bldg. VB,  
Tel. +31 40 27 82785, Fax. +31 40 27 88399

**New Zealand:** 2 Wagener Place, C.P.O. Box 1041, AUCKLAND,  
Tel. +64 9 849 4160, Fax. +64 9 849 7811

**Norway:** Box 1, Manglerud 0612, OSLO,  
Tel. +47 22 74 8000, Fax. +47 22 74 8341

**Pakistan:** see Singapore

**Philippines:** Philips Semiconductors Philippines Inc.,  
106 Valero St. Salcedo Village, P.O. Box 2108 MCC, MAKATI,  
Metro MANILA, Tel. +63 2 816 6380, Fax. +63 2 817 3474

**Poland:** Al.Jerozolimskie 195 B, 02-222 WARSAW,  
Tel. +48 22 5710 000, Fax. +48 22 5710 001

**Portugal:** see Spain

**Romania:** see Italy

**Russia:** Philips Russia, Ul. Usatcheva 35A, 119048 MOSCOW,  
Tel. +7 095 755 6918, Fax. +7 095 755 6919

**Singapore:** Lorong 1, Toa Payoh, SINGAPORE 319762,  
Tel. +65 350 2538, Fax. +65 251 6500

**Slovakia:** see Austria

**Slovenia:** see Italy

**South Africa:** S.A. PHILIPS Pty Ltd., 195-215 Main Road Martindale,  
2092 JOHANNESBURG, P.O. Box 58088 Newville 2114,  
Tel. +27 11 471 5401, Fax. +27 11 471 5398

**South America:** Al. Vicente Pinzon, 173, 6th floor,  
04547-130 SÃO PAULO, SP, Brazil,  
Tel. +55 11 821 2333, Fax. +55 11 821 2382

**Spain:** Balmes 22, 08007 BARCELONA,  
Tel. +34 93 301 6312, Fax. +34 93 301 4107

**Sweden:** Kottbygatan 7, Akalla, S-16485 STOCKHOLM,  
Tel. +46 8 5985 2000, Fax. +46 8 5985 2745

**Switzerland:** Allmendstrasse 140, CH-8027 ZÜRICH,  
Tel. +41 1 488 2741 Fax. +41 1 488 3263

**Taiwan:** Philips Semiconductors, 6F, No. 96, Chien Kuo N. Rd., Sec. 1,  
TAIPEI, Taiwan Tel. +886 2 2134 2886, Fax. +886 2 2134 2874

**Thailand:** PHILIPS ELECTRONICS (THAILAND) Ltd.,  
209/2 Sanpavuth-Bangna Road Prakanong, BANGKOK 10260,  
Tel. +66 2 745 4090, Fax. +66 2 398 0793

**Turkey:** Yukari Dudullu, Org. San. Blg., 2.Cad. Nr. 28 81260 Umraniye,  
ISTANBUL, Tel. +90 216 522 1500, Fax. +90 216 522 1813

**Ukraine:** PHILIPS UKRAINE, 4 Patrice Lumumba str., Building B, Floor 7,  
252042 KIEV, Tel. +380 44 264 2776, Fax. +380 44 268 0461

**United Kingdom:** Philips Semiconductors Ltd., 276 Bath Road, Hayes,  
MIDDLESEX UB3 5BX, Tel. +44 208 730 5000, Fax. +44 208 754 8421

**United States:** 811 East Arques Avenue, SUNNYVALE, CA 94088-3409,  
Tel. +1 800 234 7381, Fax. +1 800 943 0087

**Uruguay:** see South America

**Vietnam:** see Singapore

**Yugoslavia:** PHILIPS, Trg N. Pasica 5/v, 11000 BEOGRAD,  
Tel. +381 11 3341 299, Fax.+381 11 3342 553

**For all other countries apply to:** Philips Semiconductors,  
International Marketing & Sales Communications, Building BE-p, P.O. Box 218,  
5600 MD EINDHOVEN, The Netherlands, Fax. +31 40 27 24825

**Internet:** <http://www.semiconductors.philips.com>

© Philips Electronics N.V. 2000

SCA 69

All rights are reserved. Reproduction in whole or in part is prohibited without the prior written consent of the copyright owner.

The information presented in this document does not form part of any quotation or contract, is believed to be accurate and reliable and may be changed without notice. No liability will be accepted by the publisher for any consequence of its use. Publication thereof does not convey nor imply any license under patent- or other industrial or intellectual property rights.

Printed in The Netherlands

545004/50/01/pp48

Date of release: 2000 Jan 13

Document order number: 9397 750 05258

*Let's make things better.*

**Philips**  
Semiconductors



**PHILIPS**