

SAW FILTER FOR UMTS Band E Tx

Murata part number :SAFEA2G34MA1F0A

Package Dimensions

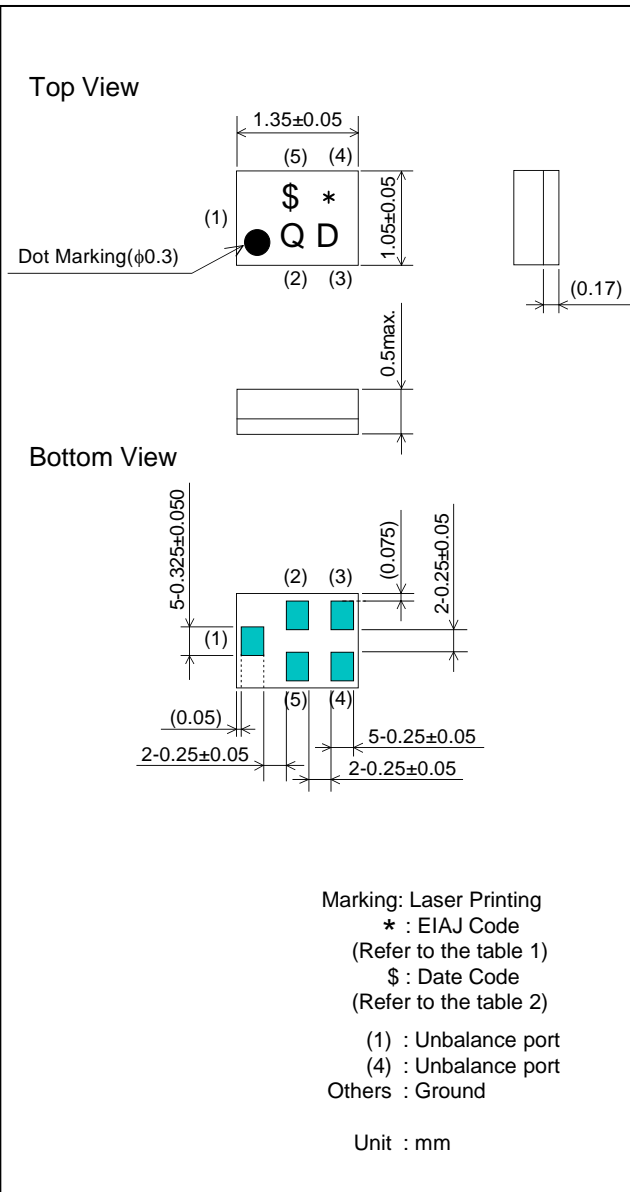

Target Specification

Item	Target Specification		
	-30 to 85°C	25±2°C	typ.
Nominal Center Frequency(f_c)	2345MHz		
Insertion Loss (2320 to 2370MHz)	3.0 dB max.	2.5 dB max.	2.0 dB
Absolute Attenuation			
1) 0.1 to 1574 MHz	23 dB min.	23 dB min.	38 dB
2) 1574 to 1577 MHz	23 dB min.	23 dB min.	38 dB
3) 1577 to 1680 MHz	23 dB min.	23 dB min.	38 dB
4) 1845 to 1880 MHz	23 dB min.	23 dB min.	40 dB
5) 2110 to 2170 MHz	28 dB min.	28 dB min.	47 dB
6) 2240 to 2285 MHz	20 dB min.	20 dB min.	34 dB
7) 2401 to 2420 MHz	15 dB min.	20 dB min.	31 dB
8) 2420 to 2440 MHz	30 dB min.	35 dB min.	44 dB
9) 2440 to 2460 MHz	30 dB min.	39 dB min.	45 dB
10) 2460 to 2480 MHz	30 dB min.	40 dB min.	48 dB
11) 2480 to 2500 MHz	30 dB min.	40 dB min.	46 dB
12) 2500 to 3000 MHz	28 dB min.	28 dB min.	43 dB
13) 4600 to 4800 MHz	20 dB min.	20 dB min.	35 dB
Ripple Deviation (2320 to 2370MHz)	2. dB max.	1.5 dB max.	1.3 dB
VSWR (2320 to 2370MHz)	2.0 max.	1.6 max.	1.3
Unbalance Port Matching Impedance (nominal)	50Ω		
Input Signal Level	+28dBm 20000 hours,55deg.C (*Input signal shall be applied to terminal number(1)		

SAW FILTER FOR UMTS Band E Tx

Murata part number :SAFEA2G34MA1F0A

■ Frequency Performance

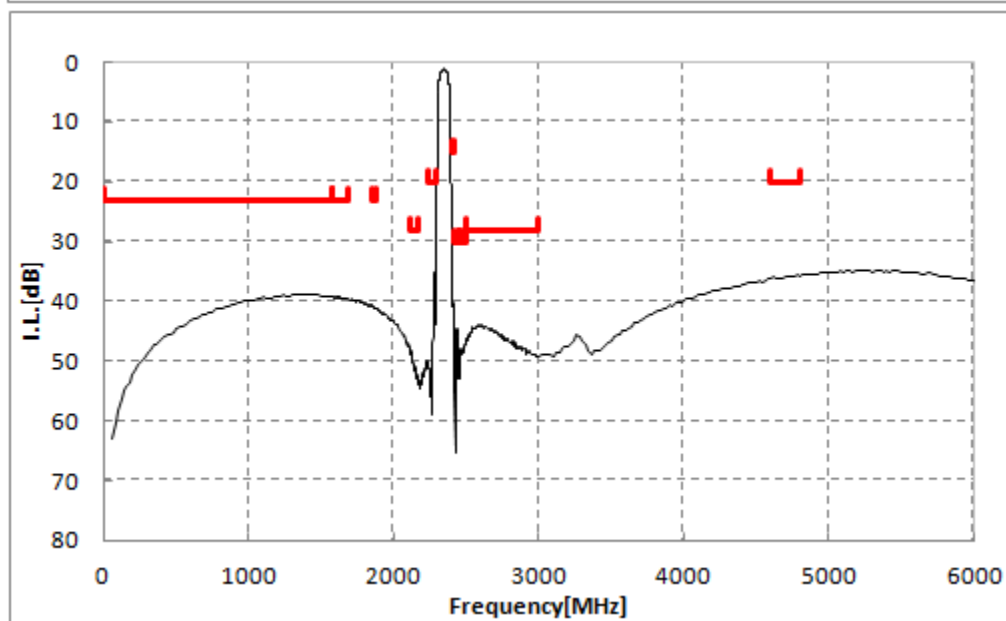
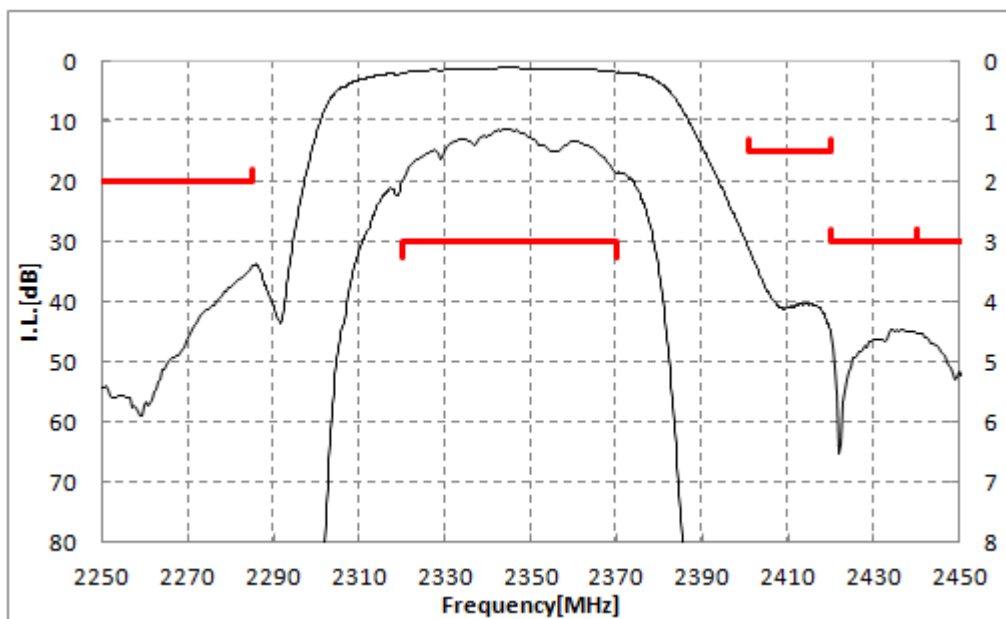

SAW FILTER FOR UMTS Band E Tx

Murata part number :SAFEA2G34MA1F0A

Preliminary

Dimensions of Carrier Tape

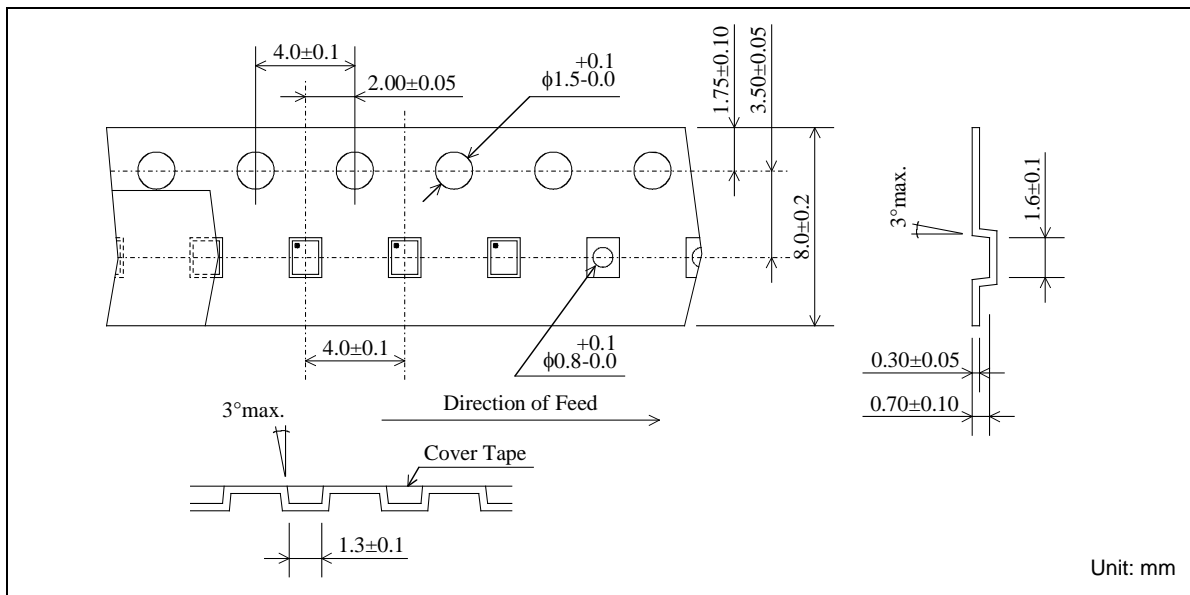

Dimensions of Tape

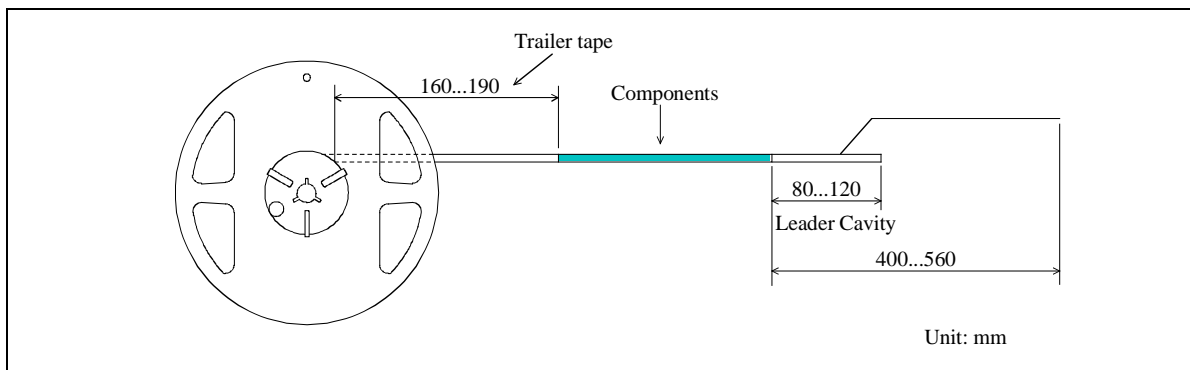

Dimensions of Reel

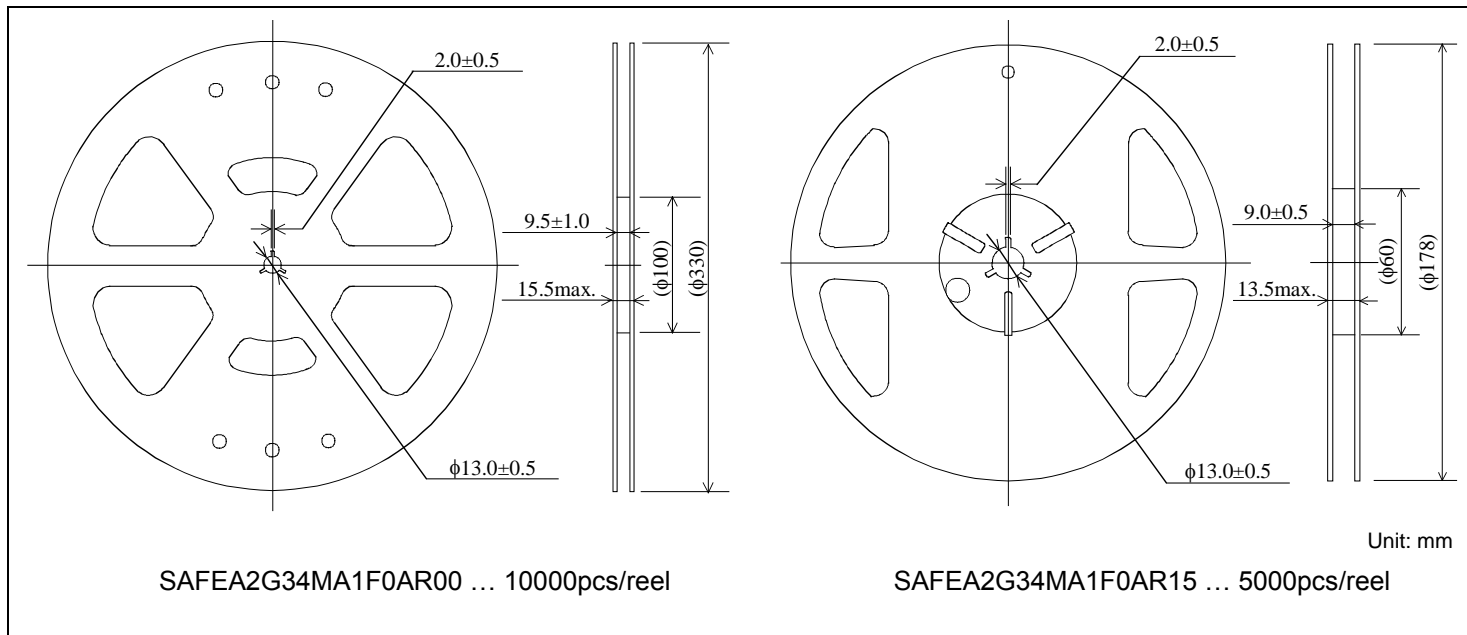

SAW FILTER FOR UMTS Band E Tx

Murata part number :SAFEA2G34MA1F0A

Recommended Land Pattern

Top View

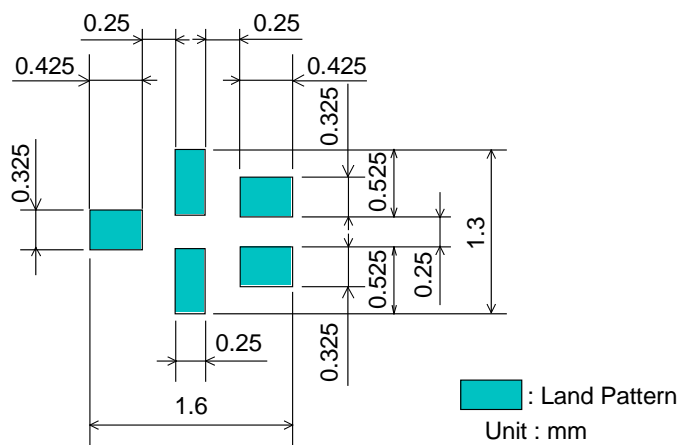

Test Circuit

Bottom View

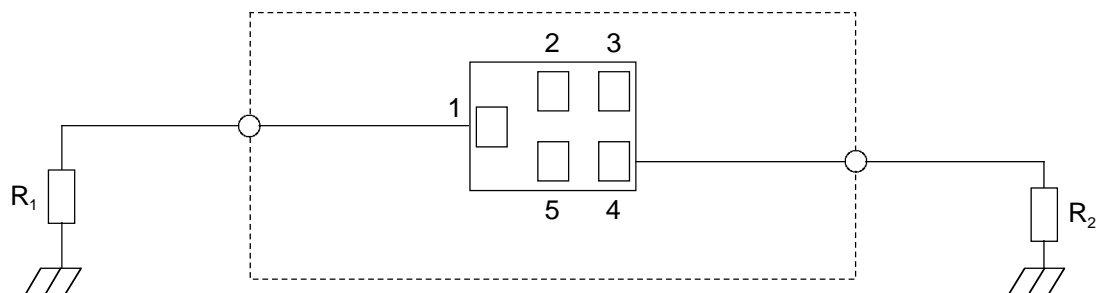

R₁ : 50Ω

R₂ : 50Ω

SAW FILTER FOR UMTS Band E Tx

Murata part number :SAFEA2G34MA1F0A

■ RoHS Compliance

This component is compliant with RoHS directive.
 This component was always RoHS compliant from the first date of manufacture.

• Caution - Limitation of Applications

This product is intended for the following applications only; however, please do not use this product in these applications where defects might directly cause damage to a third party's life, body or property.

- a. Mobile Telephone
- b. Cordless phone (except for Automotive use)
- c. PC (Including Notebook PC, Netbook PC, Tablet)
- d. Game
- e. Camera (except for Business/security use)
- f. Set Top Box
- g. Electronic dictionary
- h. Digital audio equipment

This catalog is for reference only and not an official product specification document, therefore, please review and approve our official product specification before ordering this product.

■ Marking code

Table 1 * : EIAJ Code

This rule of code is applied repeatedly every four year.

2009	Jan.	Feb.	Mar.	Apr.	May	Jun.	Jul.	Aug.	Sep.	Oct.	Nov.	Dec.
2013	A	B	C	D	E	F	G	H	J	K	L	M
2017												
2010	Jan.	Feb.	Mar.	Apr.	May	Jun.	Jul.	Aug.	Sep.	Oct.	Nov.	Dec.
2014	N	P	Q	R	S	T	U	V	W	X	Y	Z
2018												
2011	Jan.	Feb.	Mar.	Apr.	May	Jun.	Jul.	Aug.	Sep.	Oct.	Nov.	Dec.
2015	a	b	c̄	d	e	f	g	h	j	k	l	m
2019												
2012	Jan.	Feb.	Mar.	Apr.	May	Jun.	Jul.	Aug.	Sep.	Oct.	Nov.	Dec.
2016	n	p	q	r	s	t	u	v	w	x	y	z
2020												

Table 2 \$: Date Code

date	1st	2nd	3rd	4th	5th	6th	7th	8th	9th	10th	
code	A	B	C	D	E	F	G	H	J	K	
date	11th	12th	13th	14th	15th	16th	17th	18th	19th	20th	
code	L	M	N	P	Q	R	S	T	U	V	
date	21st	22nd	23rd	24th	25th	26th	27th	28th	29th	30th	31st
code	W	X	Y	Z	a	b	c̄	d	e	f	g

SAW FILTER FOR UMTS Band E Tx

Murata part number :SAFEA2G34MA1F0A

■Important notice

PLEASE READ THIS NOTICE BEFORE USING OUR PRODUCTS.

Please make sure that your product has been evaluated and confirmed from the aspect of the fitness for the specifications of our product when our product is mounted to your product.

All the items and parameters in this product specification/datasheet/catalog have been prescribed on the premise that our product is used for the purpose, under the condition and in the environment specified in this specification. You are requested not to use our product deviating from the condition and the environment specified in this specification. Please note that the only warranty that we provide regarding the products is its conformance to the specifications provided herein. Accordingly, we shall not be responsible for any defects in products or equipment incorporating such products, which are caused under the conditions other than those specified in this specification.

WE HEREBY DISCLAIMS ALL OTHER WARRANTIES REGARDING THE PRODUCTS, EXPRESS OR IMPLIED, INCLUDING WITHOUT LIMITATION ANY WARRANTY OF FITNESS FOR A PARTICULAR PURPOSE, THAT THEY ARE DEFECT-FREE, OR AGAINST INFRINGEMENT OF INTELLECTUAL PROPERTY RIGHTS.

The product shall not be used in any application listed below which requires especially high reliability for the prevention of such defect as may directly cause damage to the third party's life, body or property. You acknowledge and agree that, if you use our products in such applications, we will not be responsible for any failure to meet such requirements. Furthermore, YOU AGREE TO INDEMNIFY AND DEFEND US AND OUR AFFILIATES AGAINST ALL CLAIMS, DAMAGES, COSTS, AND EXPENSES THAT MAY BE INCURRED, INCLUDING WITHOUT LIMITATION, ATTORNEY FEES AND COSTS, DUE TO THE USE OF OUR PRODUCTS IN SUCH APPLICATIONS.

- Aircraft equipment.
- Aerospace equipment
- Undersea equipment.
- Power plant control equipment - Medical equipment.
- Transportation equipment (vehicles, trains, ships, elevator, etc.).
- Traffic signal equipment.
- Disaster prevention / crime prevention equipment.
- Burning / explosion control equipment
- Application of similar complexity and/ or reliability requirements to the applications listed in the above.

We expressly prohibit you from analyzing, breaking, Reverse-Engineering, remodeling altering, and reproducing our product. Our product cannot be used for the product which is prohibited from being manufactured, used, and sold by the regulations and laws in the world.

We do not warrant or represent that any license, either express or implied, is granted under any our patent right, copyright, mask work right, or our other intellectual property right relating to any combination, machine, or process in which our products or services are used. Information provided by us regarding third-party products or services does not constitute a license from us to use such products or services or a warranty or endorsement thereof. Use of such information may require a license from a third party under the patents or other intellectual property of the third party, or a license from us under our patents or other intellectual property.

Please do not use our products, our technical information and other data provided by us for the purpose of developing of mass-destruction weapons and the purpose of military use. Moreover, you must comply with "foreign exchange and foreign trade law", the "U.S. export administration regulations", etc.

Please note that we may discontinue the manufacture of our products, due to reasons such as end of supply of materials and/or components from our suppliers.

SAW FILTER FOR UMTS Band E Tx

Murata part number :SAFEA2G34MA1F0A

Customer acknowledges that Murata will, if requested by you, conduct a failure analysis for defect or alleged defect of Products only at the level required for consumer grade Products, and thus such analysis may not always be available or be in accordance with your request (for example, in cases where the defect was caused by components in Products supplied to Murata from a third party).

The product shall not be used in any other application/model than that of claimed to Murata.

Customer acknowledges that engineering samples may deviate from specifications and may contain defects due to their development status.

We reject any liability or product warranty for engineering samples.

In particular we disclaim liability for damages caused by

- the use of the engineering sample other than for evaluation purposes, particularly the installation or integration in the product to be sold by you,
- deviation or lapse in function of engineering sample,
- improper use of engineering samples.

We disclaims any liability for consequential and incidental damages.

If you can't agree the above contents, you should inquire our sales.