

SAW FILTER FOR GSM850/BAND5 Rx

Murata part number : SAFFB881MAN0F0A

Package Dimensions

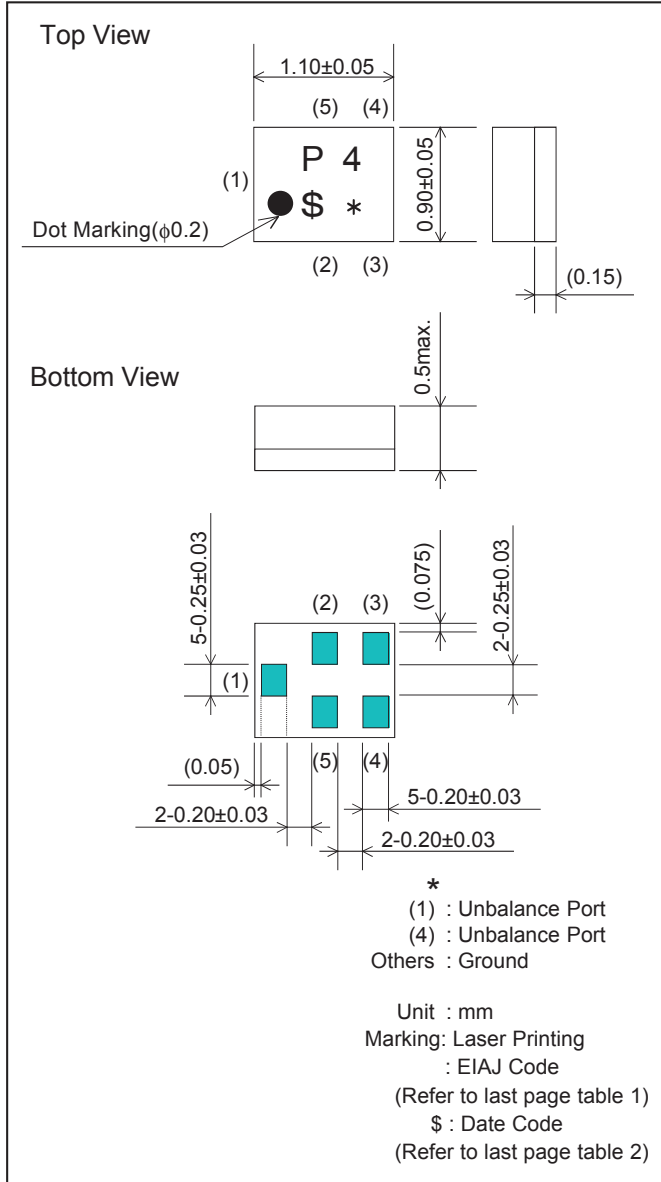

Specification

Item	Target Specification		
	-30 to 85°C	25±2°C	typ.
Nominal Center Frequency(fc)	881.5MHz		
Insertion Loss			
1) 871.4 to 891.6 MHz *	1.5 dB _{INT} max.	1.3 dB _{INT} max.	1.1 dB _{INT}
2) 869 to 894 MHz	1.6 dB max.	1.4 dB max.	1.2 dB
Absolute Attenuation			
1) 1738 to 1788 MHz	38 dB min.	38 dB min.	44 dB
2) 2607 to 2682 MHz	33 dB min.	33 dB min.	39 dB
3) 3476 to 3576 MHz	30 dB min.	30 dB min.	37 dB
4) 4345 to 4470 MHz	30 dB min.	30 dB min.	36 dB
5) 5214 to 5364 MHz	30 dB min.	30 dB min.	36 dB
6) 6083 to 6258 MHz	30 dB min.	30 dB min.	38 dB
7) 6952 to 7152 MHz	30 dB min.	30 dB min.	40 dB
8) 7821 to 8046 MHz	30 dB min.	30 dB min.	43 dB
9) 8690 to 8940 MHz	28 dB min.	28 dB min.	44 dB
10) 9559 to 9834 MHz	25 dB min.	25 dB min.	33 dB
11) 10428 to 10728 MHz	22 dB min.	22 dB min.	27 dB
12) 11297 to 11622 MHz	18 dB min.	18 dB min.	23 dB
13) 824 to 849 MHz	42 dB min.	42 dB min.	47 dB
14) 2400 to 2500 MHz	33 dB min.	33 dB min.	39 dB
15) 5725 to 5875 MHz	30 dB min.	30 dB min.	37 dB
16) 1693 to 1743 MHz	38 dB min.	38 dB min.	44 dB
17) 45 to 45 MHz	50 dB min.	50 dB min.	70 dB
18) 2517 to 2592 MHz	33 dB min.	33 dB min.	39 dB
19) 779 to 804 MHz	46 dB min.	46 dB min.	51 dB
20) 846.5 to 854 MHz	30 dB min.	35 dB min.	47 dB
Ripple Deviation			
869 to 894 MHz	1.0 dB max.	0.8 dB max.	0.4 dB
Ripple Deviation any 5MHz			
869 to 894 MHz	0.8 dB max.	0.6 dB max.	0.3 dB
VSWR			
869 to 894 MHz	1.8 max.	1.7 max.	1.4
Unbalance Port Matching Impedance	50Ω		
Unbalance Port Matching Impedance	50Ω		
Input Signal Level	31.6mW (+15dBm), 2000 hours		

* Integration calculation (dB_{INT}):

$$dB_{INT} = 10 \log \left[\frac{\sum_{n=2}^N \left[\frac{(10^{(L_{\infty}(f_{n-1})/10)} + 10^{(L_{\infty}(f_n)/10)})}{2} \times (F_n - F_{n-1}) \right]}{F_N - F_1} \right]$$

SAW FILTER FOR GSM850/BAND5 Rx

Murata part number : SAFFB881MAN0F0A

■ Frequency Performance

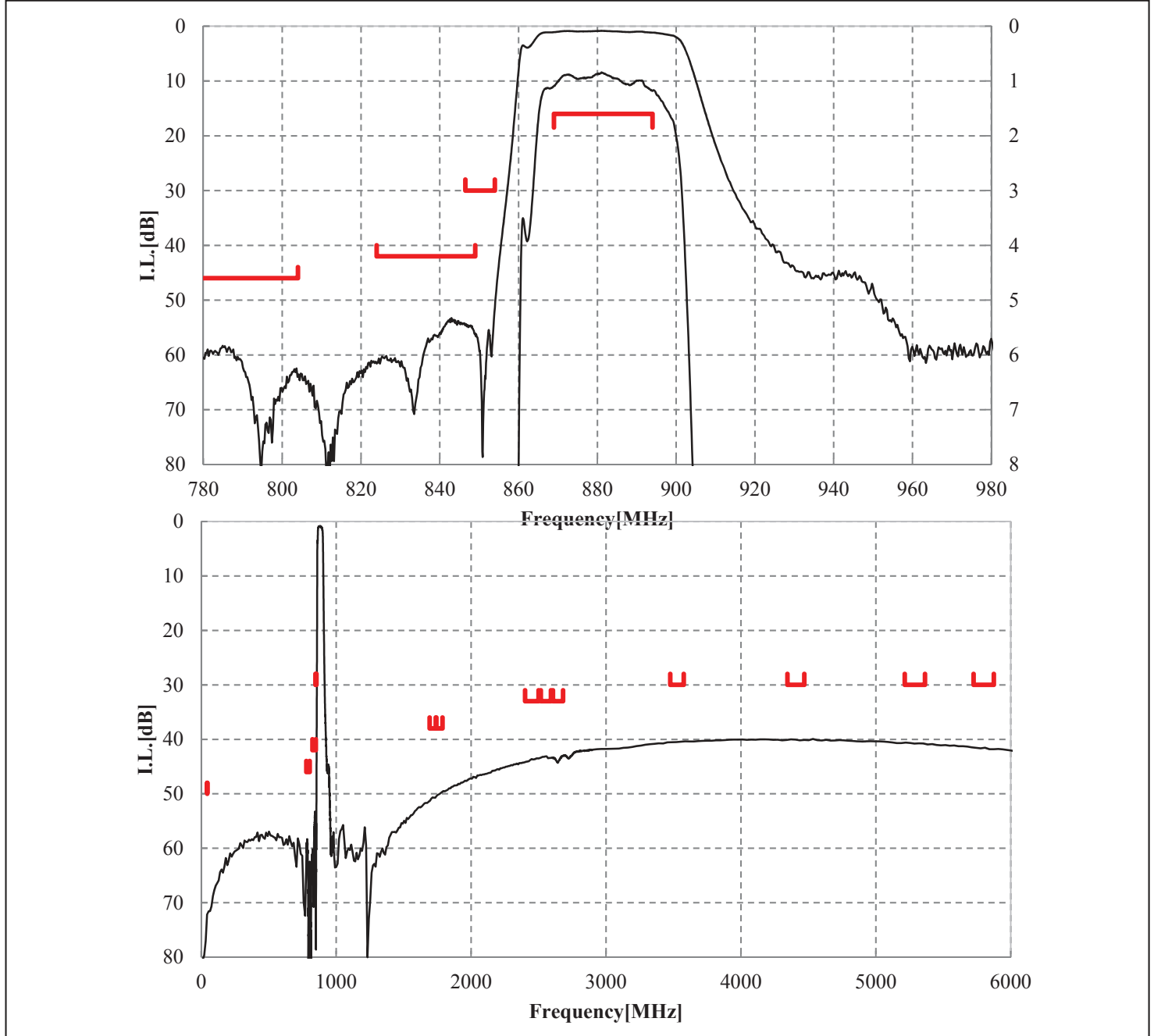

SAW FILTER FOR GSM850/BAND5 Rx

Murata part number : SAFFB881MAN0F0A

■ Dimensions of Carrier Tape

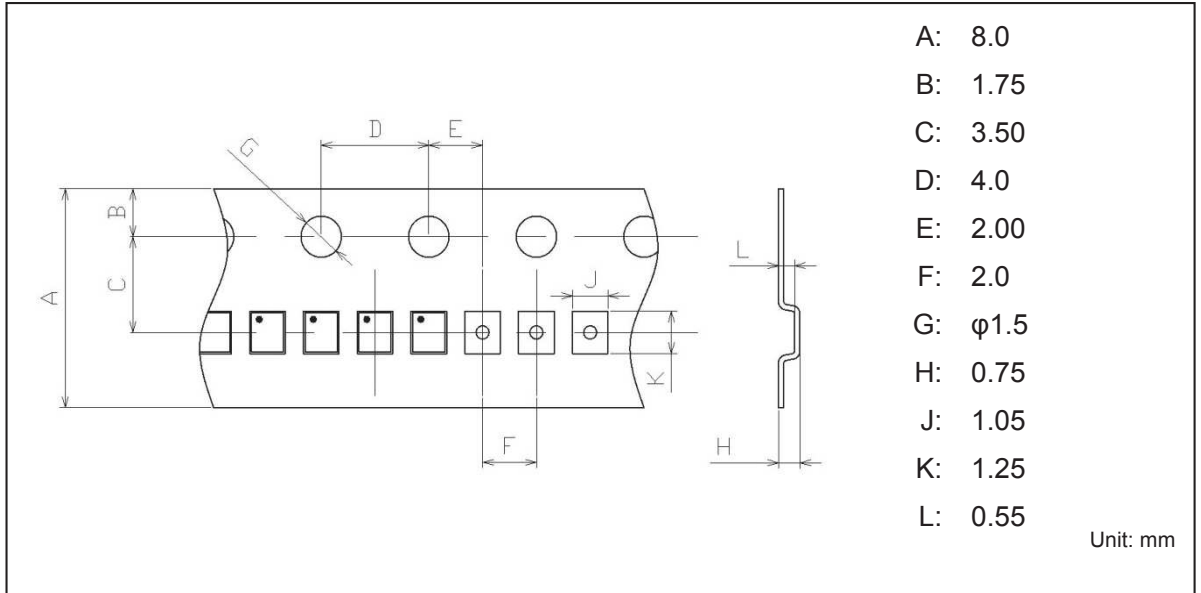

■ Dimensions of Tape

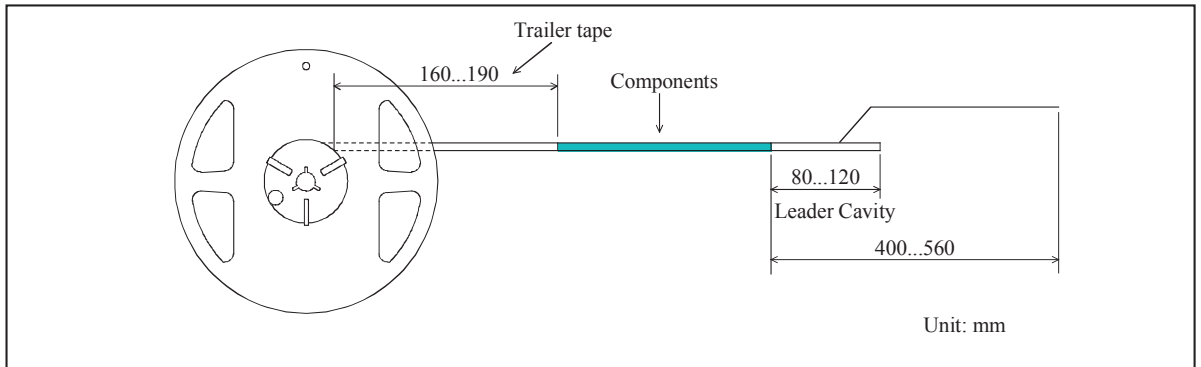

■ Dimensions of Reel

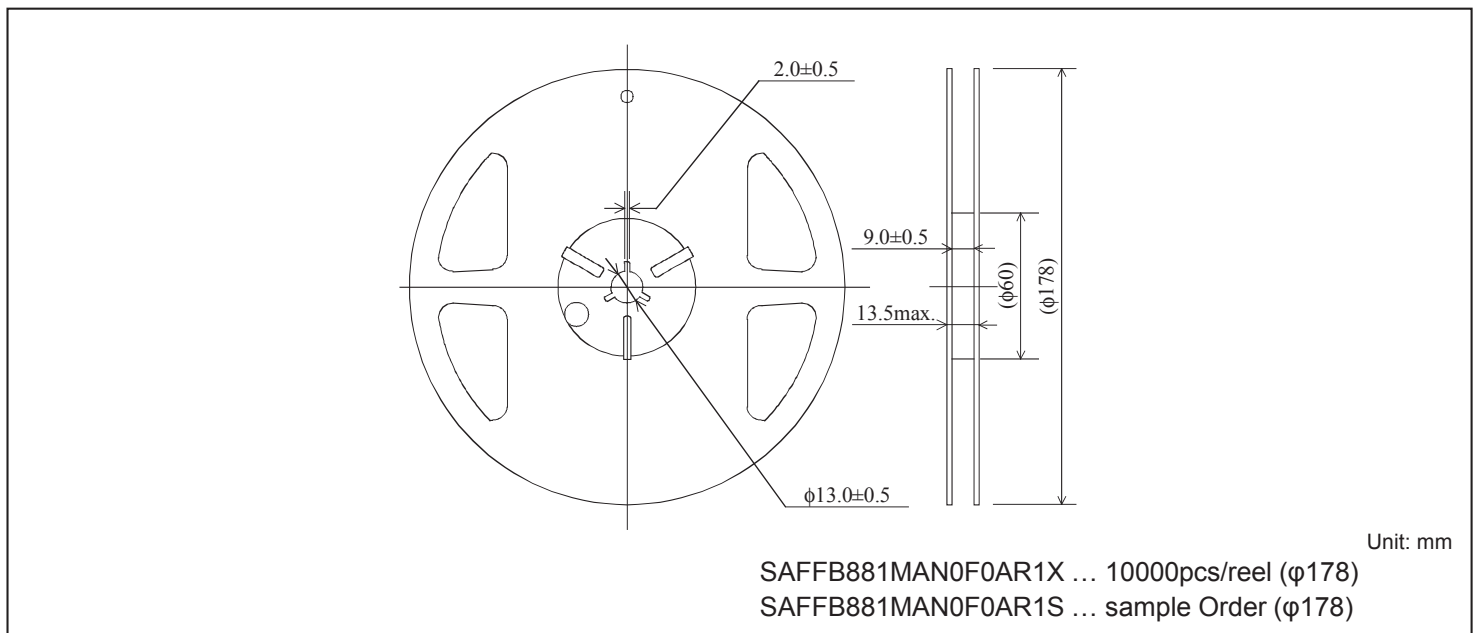

SAW FILTER FOR GSM850/BAND5 Rx

Murata part number : SAFFB881MAN0F0A

Recommended Land Pattern

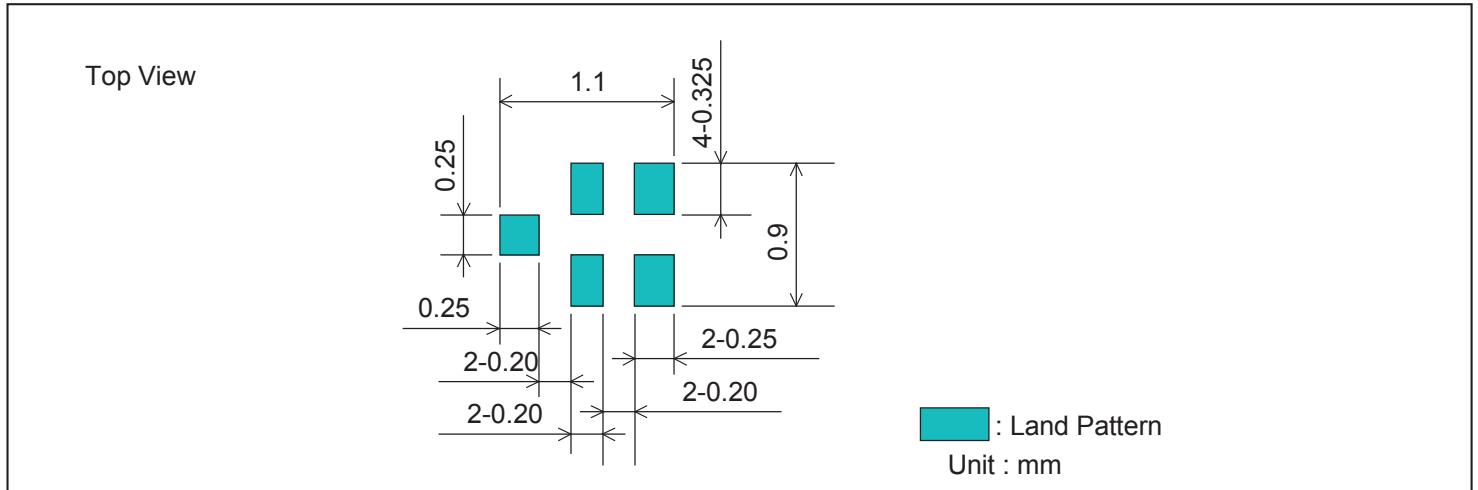

Test Circuit

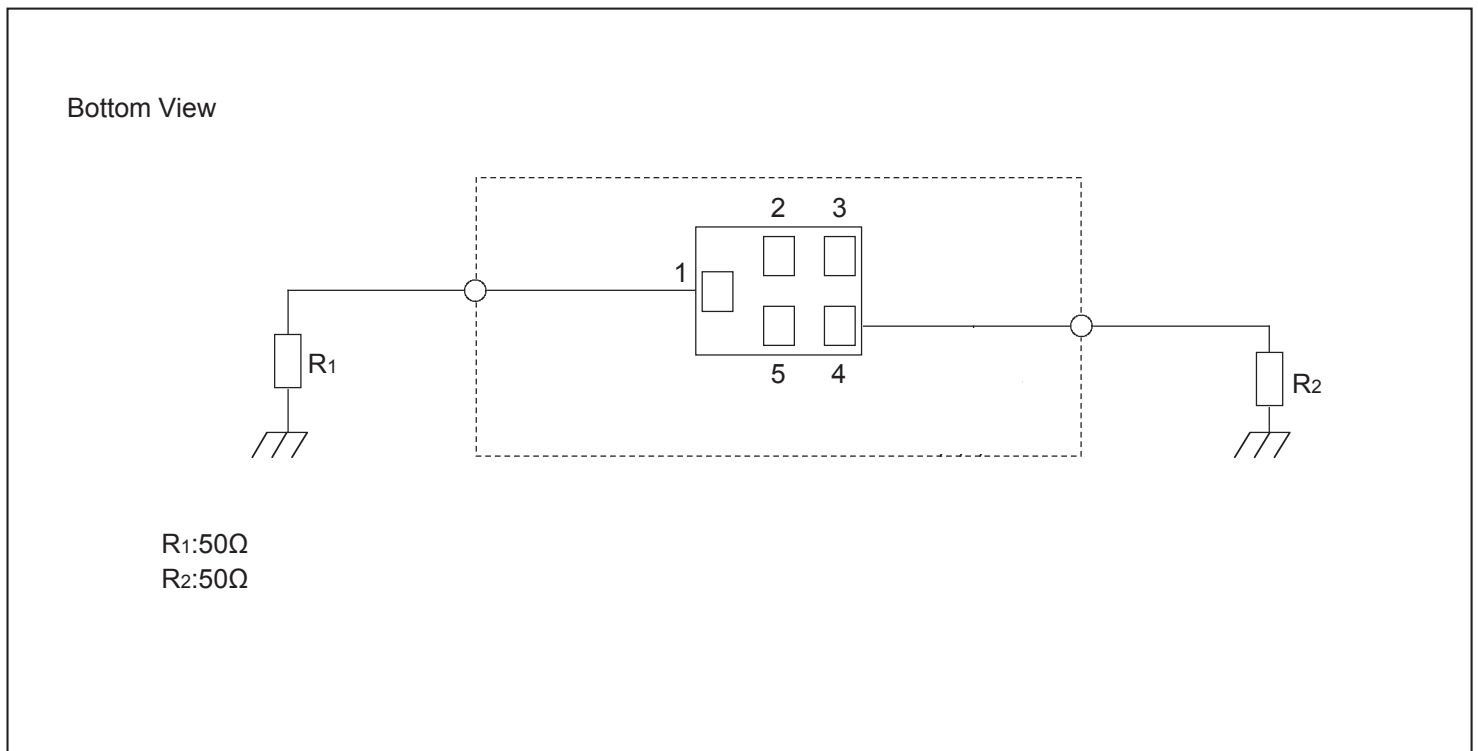

SAW FILTER FOR GSM850/BAND5 Rx

Murata part number : SAFFB881MAN0F0A

■ RoHS Compliance

This component is compliant with RoHS directive.

This component was always RoHS compliant from the first date of manufacture.

• Caution - Limitation of Applications

This product is intended for the following applications only; however, please do not use this product in these applications where defects might directly cause damage to a third party's life, body or property.

- a. Mobile Telephone
- b. Cordless phone (except for Automotive use)
- c. PC (Including Notebook PC, Netbook PC, Tablet)
- d. Game
- e. Camera (except for Business/security use)
- f. Set Top Box
- g. Electronic dictionary
- h. Digital audio equipment

• This catalog is for reference only and not an official product specification document, therefore, please review and approve our official product specification before ordering this product.

■ Marking code

Table 1 * : EIAJ Code

This rule of code is applied repeatedly every four year.

2013 2017 2021	Jan.	Feb.	Mar.	Apr.	May.	Jun.	Jul.	Aug.	Sep.	Oct.	Nov.	Dec.
	A	B	C	D	E	F	G	H	J	K	L	M
2014 2018 2022	Jan.	Feb.	Mar.	Apr.	May.	Jun.	Jul.	Aug.	Sep.	Oct.	Nov.	Dec.
	N	P	Q	R	S	T	U	V	W	X	Y	Z
2015 2019 2023	Jan.	Feb.	Mar.	Apr.	May.	Jun.	Jul.	Aug.	Sep.	Oct.	Nov.	Dec.
	a	b	c̄	d	e	f	g	h	j	k	l	m
2016 2020 2024	Jan.	Feb.	Mar.	Apr.	May.	Jun.	Jul.	Aug.	Sep.	Oct.	Nov.	Dec.
	n	p	q	r	s	t	u	v	w	x	y	z

Table 2 \$: Date Code

date	1st	2nd	3rd	4th	5th	6th	7th	8th	9th	10th		
code	A	B	C	D	E	F	G	H	J	K		
date	11th	12th	13th	14th	15th	16th	17th	18th	19th	20th		
code	L	M	N	P	Q	R	S	T	U	V		
date	21st	22nd	23rd	24th	25th	26th	27th	28th	29th	30th	31st	
code	W	X	Y	Z	a	b	c̄	d	e	f	g	

SAW FILTER FOR GSM850/BAND5 Rx

Murata part number : SAFFB881MAN0F0A

■ Important notice

PLEASE READ THIS NOTICE BEFORE USING OUR PRODUCTS.

Please make sure that your product has been evaluated and confirmed from the aspect of the fitness for the specifications of our product when our product is mounted to your product.

All the items and parameters in this product specification/datasheet/catalog have been prescribed on the premise that our product is used for the purpose, under the condition and in the environment specified in this specification. You are requested not to use our product deviating from the condition and the environment specified in this specification.

Please note that the only warranty that we provide regarding the products is its conformance to the specifications provided herein. Accordingly, we shall not be responsible for any defects in products or equipment incorporating such products, which are caused under the conditions other than those specified in this specification.

WE HEREBY DISCLAIMS ALL OTHER WARRANTIES REGARDING THE PRODUCTS, EXPRESS OR IMPLIED, INCLUDING WITHOUT LIMITATION ANY WARRANTY OF FITNESS FOR A PARTICULAR PURPOSE, THAT THEY ARE DEFECT-FREE, OR AGAINST INFRINGEMENT OF INTELLECTUAL PROPERTY RIGHTS.

The product shall not be used in any application listed below which requires especially high reliability for the prevention of such defect as may directly cause damage to the third party's life, body or property. You acknowledge and agree that, if you use our products in such applications, we will not be responsible for any failure to meet such requirements.

Important Notice (2/2)

Furthermore, YOU AGREE TO INDEMNIFY AND DEFEND US AND OUR AFFILIATES AGAINST ALL CLAIMS, DAMAGES, COSTS, AND EXPENSES THAT MAY BE INCURRED, INCLUDING WITHOUT LIMITATION, ATTORNEY FEES AND COSTS, DUE TO THE USE OF OUR PRODUCTS IN SUCH APPLICATIONS.

- Aircraft equipment.
- Aerospace equipment
- Undersea equipment.
- Power plant control equipment - Medical equipment.
- Transportation equipment (vehicles, trains, ships, elevator, etc.).
- Traffic signal equipment.
- Disaster prevention / crime prevention equipment.
- Burning / explosion control equipment
- Application of similar complexity and/ or reliability requirements to the applications listed in the above.

We expressly prohibit you from analyzing, breaking, Reverse-Engineering, remodeling altering, and reproducing our product. Our product cannot be used for the product which is prohibited from being manufactured, used, and sold by the regulations and laws in the world.

Please do not use the product in molding condition

This product is ESD (ElectroStatic Discharge) sensitive device.

When you install or measure this, you should be careful not to add antistatic electricity or high voltage.

Please be advised that you had better check anti surge voltage.

SAW FILTER FOR GSM850/BAND5 Rx

Murata part number : SAFFB881MAN0F0A

We do not warrant or represent that any license, either express or implied, is granted under any our patent right, copyright, mask work right, or our other intellectual property right relating to any combination, machine, or process in which our products or services are used. Information provided by us regarding third-party products or services does not constitute a license from us to use such products or services or a warranty or endorsement thereof. Use of such information may require a license from a third party under the patents or other intellectual property of the third party, or a license from us under our patents or other intellectual property.

Please do not use our products, our technical information and other data provided by us for the purpose of developing of mass-destruction weapons and the purpose of military use.

Moreover, you must comply with "foreign exchange and foreign trade law", the "U.S. export administration regulations", etc.

Please note that we may discontinue the manufacture of our products, due to reasons such as end of supply of materials and/or components from our suppliers.

Customer acknowledges that Murata will, if requested by you, conduct a failure analysis for defect or alleged defect of Products only at the level required for consumer grade Products, and thus such analysis may not always be available or be in accordance with your request (for example, in cases where the defect was caused by components in Products supplied to Murata from a third party).

The product shall not be used in any other application/model than that of claimed to Murata.

Customer acknowledges that engineering samples may deviate from specifications and may contain defects due to their development status.

We reject any liability or product warranty for engineering samples.

In particular we disclaim liability for damages caused by

- the use of the engineering sample other than for evaluation purposes, particularly the installation or integration in the product to be sold by you,
- deviation or lapse in function of engineering sample,
- improper use of engineering samples.

We disclaim any liability for consequential and incidental damages.

If you can't agree the above contents, you should inquire our sales.