

DESCRIPTION

The SAT1600 combines four independent optocouplers in a 16 pin DIP/SMD package. Each of the four optocoupler circuits is composed of two input LEDs optically-coupled to a Phototransistor--allowing for high isolation levels while maintaining low-level AC signal control capability. The SAT1600 provides an optically isolated method of controlling many interface applications such as telecommunications, industrial control and instrumentation circuitry.

FEATURES

- High input-to-output isolation package
- Low input power consumption
- High stability

APPLICATIONS

- Loop current detection
- Ring signal detection
- Power supply feedback isolation
- Audio signal interface, Telephone sets, Telephone exchangers
- Transformer replacement, System appliances, Sensors etc.

OPTIONS/SUFFIXES

- -H High input-to-output isolation voltage (5000Vrms)
- -S Surface Mount Option
- -TR Tape and Reel Option

MAXIMUM RATINGS

PARAMETER	UNIT	MIN	TYP	MAX
Storage Temperature	°C	-55		125
Operating Temperature	°C	-40		85
Continuous Input Current	mA			±50
Transient Input Current	A			± 1
Collector-emitter Voltage	V			60
Output Power Dissipation	mW			200

SCHEMATIC DIAGRAM

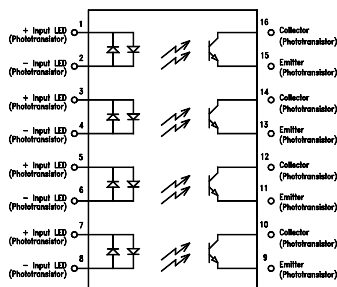

APPROVALS

- UL and C-UL Approved File #E201932.

ELECTRICAL CHARACTERISTICS - 25°

PARAMETER	UNIT	MIN	TYP	MAX	TEST CONDITIONS
INPUT SPECIFICATIONS					
LED Forward Voltage	V		1.2	1.4	If = ±20mA
OUTPUT SPECIFICATIONS					
Collector-Emitter Breakdown Voltage	V	60			Ic = 10uA
Emitter-Collector Breakdown Voltage	V	3.5			Ie = 1uA
Dark Current	uA			0.1	Vce = 20V
Floating Capacitance	p F		0.6		V= 0V, f=1.0MHz
Saturation Voltage	V		0.1	0.3	If =± 20mA, Ic = 1mA
Current Transfer Ratio	%	60		600	If = ±1mA, Vce = 5V
Rise Time	μ s		5		Ic = 2mA, Vce = 2V, Rc = 100 ohms
Fall Time	μ s		4		Ic = 2mA, Vce = 2V, Rc = 100 ohms
COUPLED SPECIFICATIONS					
Isolation Voltage	V	5000			T = 1 minute
Cut-off frequency	kHz		80		Vcc=5V, Ic=2mA, Rc=100 ohms
Isolation Resistance	G Ω	50			

Fig.1 Current Transfer Ratio vs. Forward Current

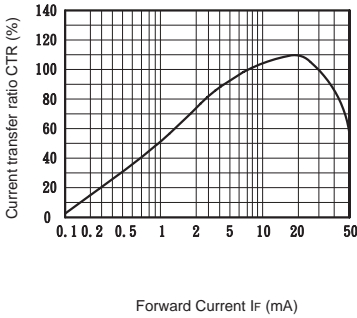

Fig.2 Collector Power Dissipation vs. Ambient Temperature

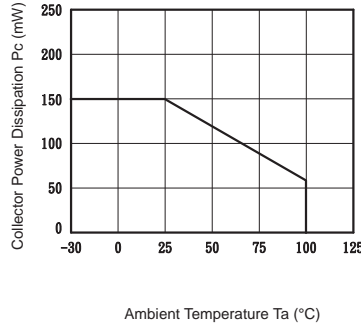

Fig.3 Collector Dark Current vs. Ambient Temperature

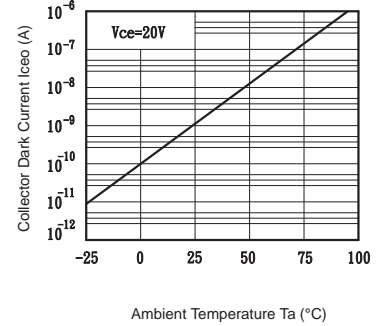

Fig.4 Forward Current vs. Ambient Temperature

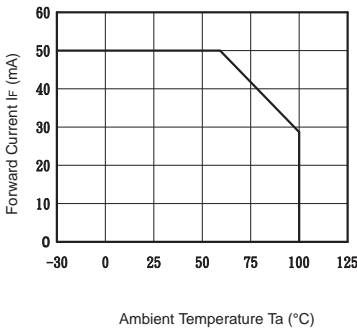

Fig.5 Forward Current vs. Forward Voltage

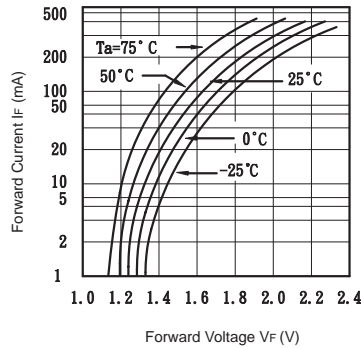

Fig.6 Collector Current vs. Collector-emitter Voltage

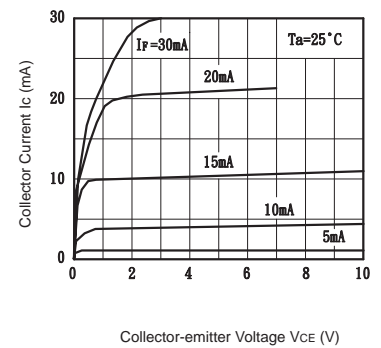

Fig.7 Relative Current Transfer Ratio vs. Ambient Temperature

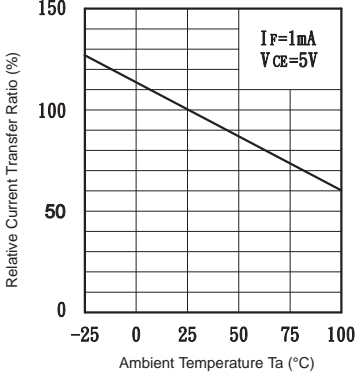

Fig.8 Collector-emitter Saturation Voltage vs. Ambient Temperature

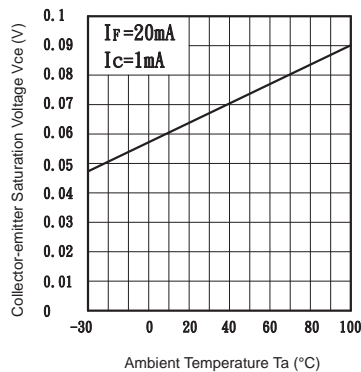

Fig.9 Collector-emitter Saturation Voltage vs. Forward Current

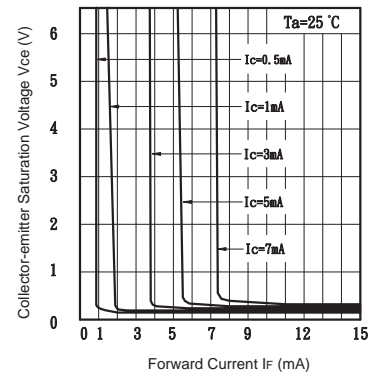

Fig.10 Response Time vs. Load Resistance

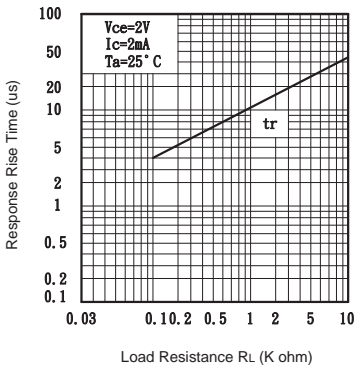
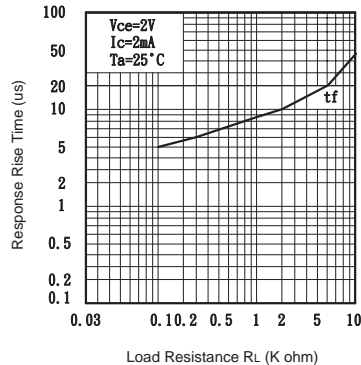
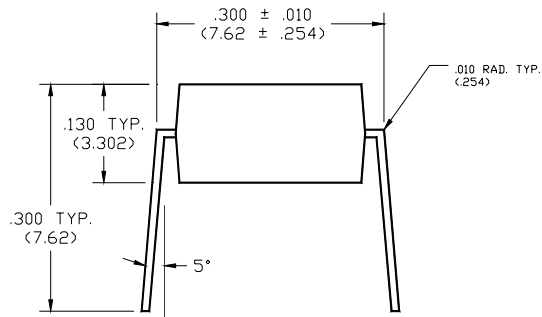

Fig.11 Response Time vs. Load Resistance



MECHANICAL DIMENSIONS

16 PIN DUAL IN-LINE PACKAGE



END VIEW

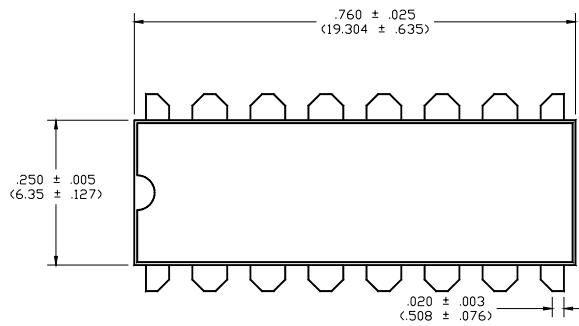

TOP VIEW

16 PIN SURFACE MOUNT DEVICE

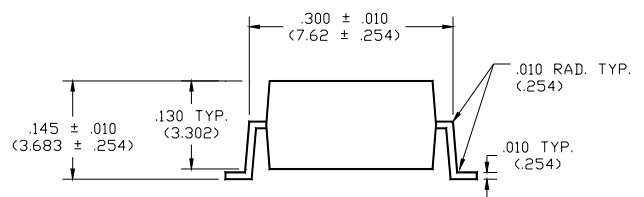

END VIEW

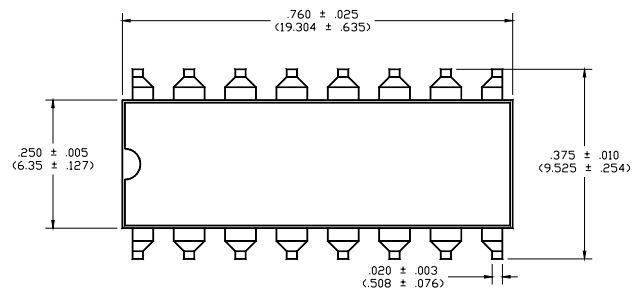

TOP VIEW