

Data Sheet

Features

- For 3G applications
- 15 MHz bandwidth for high data rates
- High attenuation
- Single-ended operation at 50Ω
- Ceramic Surface Mount Package (SMP)
- Small size

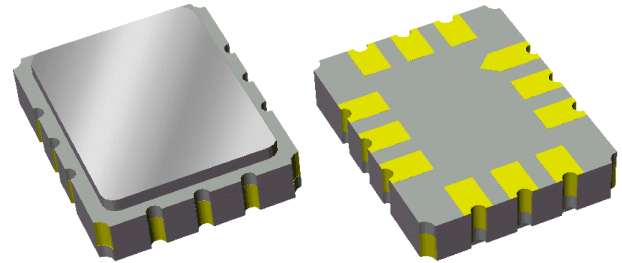

Package

Surface Mount 7.01 x 5.51 x 1.63 mm

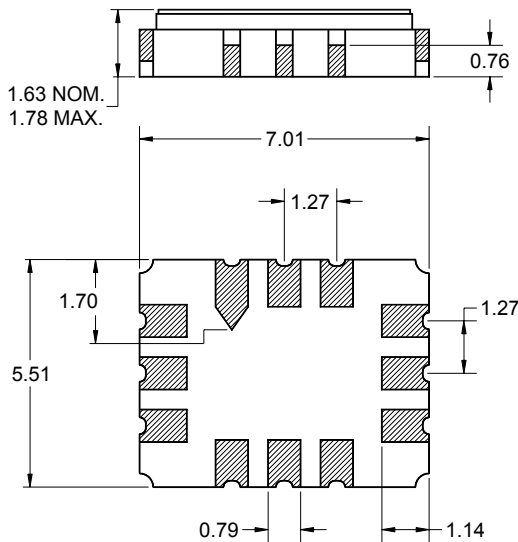

Dimensions shown are nominal in millimeters
All tolerances are ± 0.15 mm except overall
length and width ± 0.13 mm

Body: Al_2O_3 ceramic
Lid: Kovar, Ni plated
Terminations: Au plating 0.5 - 1.0 μ m,
over a 2 - 6 μ m Ni plating

Pin Configuration

Bottom View

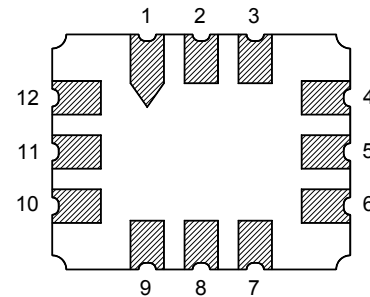

Pin No.	Description
4	Output
10	Input
1,2,3,5,6	Case ground
7,8,9,11,12	Case ground

Data Sheet

Electrical Specifications ⁽¹⁾

Temperature Range: ⁽²⁾ -10 to +80 °C

Parameter ⁽³⁾	Minimum	Typical	Maximum	Unit
Center Frequency	-	326.4	-	MHz
Minimum Insertion Loss	-	12.61	17	dB
2 dB Lower Frequency	-	317.77	318.9	MHz
2 dB Upper Frequency	333.9	335.18	-	MHz
2 dB Bandwidth	15	17.4	-	MHz
40 dB Lower Frequency	313.9	314.62	-	MHz
40 dB Upper Frequency	-	338.31	338.9	MHz
40 dB Bandwidth	-	23.69	25	MHz
Relative Attenuation				
10 - 276.4 MHz	50	60	-	dB
276.4 - 306.4 MHz	45	51	-	dB
346.4 - 376.4 MHz	45	56	-	dB
376.4 - 450 MHz	50	64	-	dB
Amplitude Ripple				
323.9 - 328.9 MHz	-	0.2	0.5	dB p-p
Group Delay Variation				
318.9 - 333.9 MHz	-	24	50	nsec
Input VSWR				
318.9 - 333.9 MHz	-	1.33:1	2.0:1	-
Output VSWR				
318.9 - 333.9 MHz	-	1.34:1	2.0:1	-
Source Impedance ⁽⁴⁾	-	50	-	Ω
Load Impedance ⁽⁴⁾	-	50	-	Ω

Notes:

1. All specifications are based on the test circuit shown below
2. In production, devices will be tested at room temperature to a guardbanded specification to ensure electrical compliance over temperature
3. Electrical margin has been built into the design to account for the variations due to temperature drift and manufacturing tolerances
4. This is the optimum impedance in order to achieve the performance shown

Test Circuit:

Actual matching values may vary due to PCB layout and parasitics

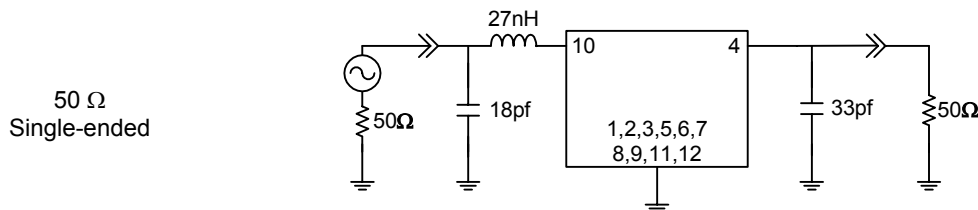

Data Sheet

Typical Performance (at +25°C)

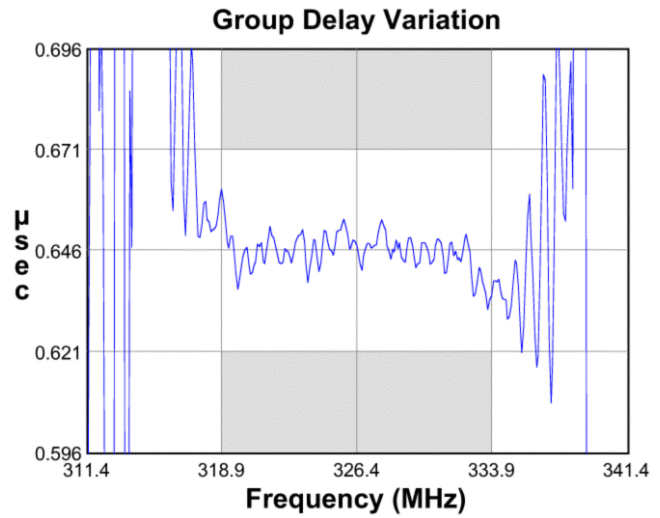
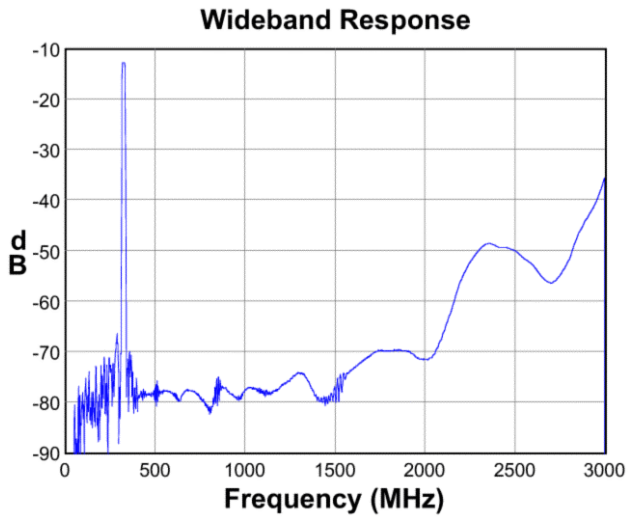
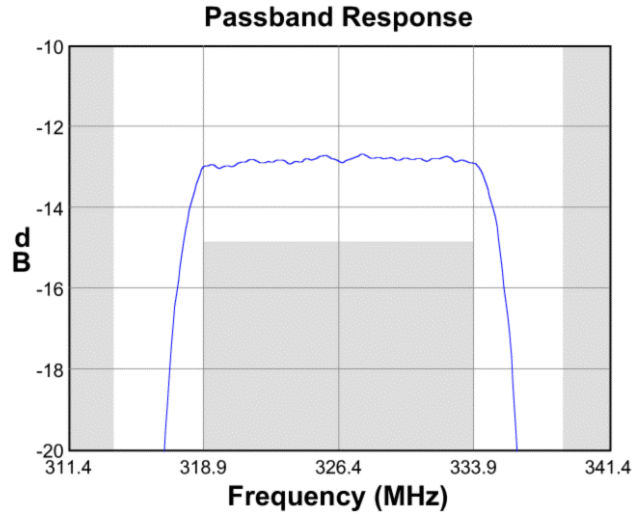
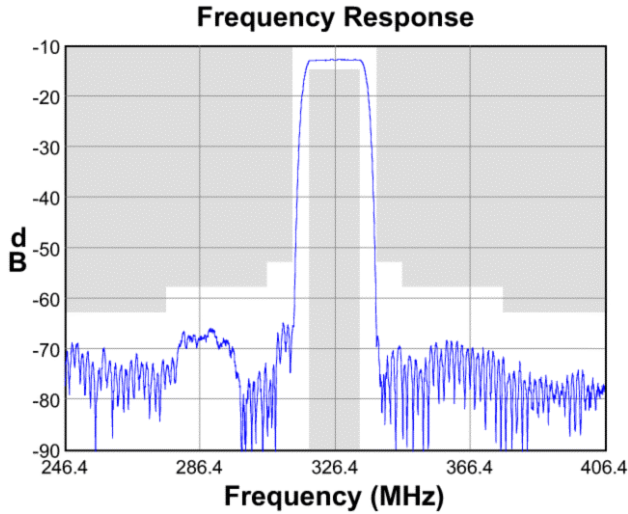

Input Smith Chart

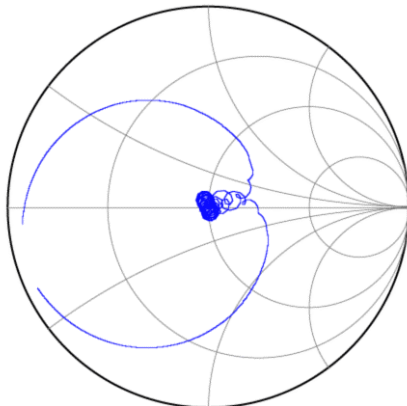

Output Smith Chart

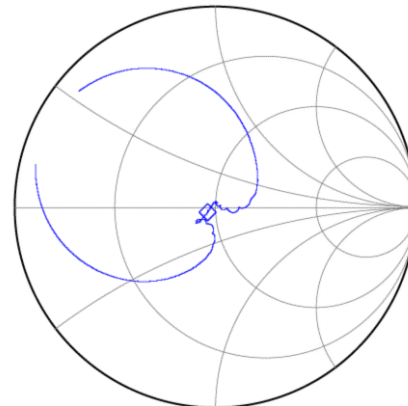

Data Sheet

Matching Schematics

Actual matching values may vary due to PCB layout and parasitics

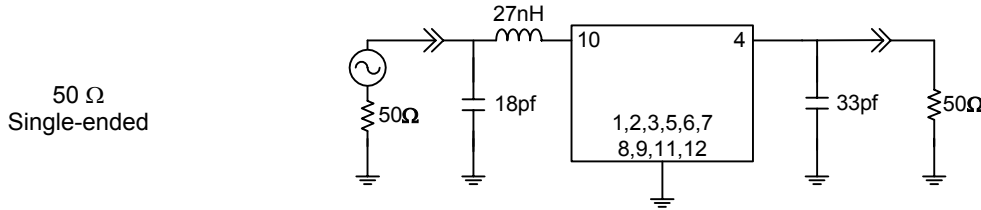

Marking



The date code consists of: day of the current year (Julian, 3 digits), last digit of the year (1 digit) and hour (2 digits)

PCB Footprint

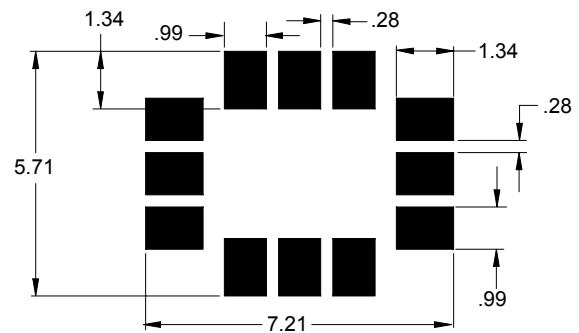

This footprint represents a recommendation only
Dimensions shown are nominal in millimeters

Tape and Reel

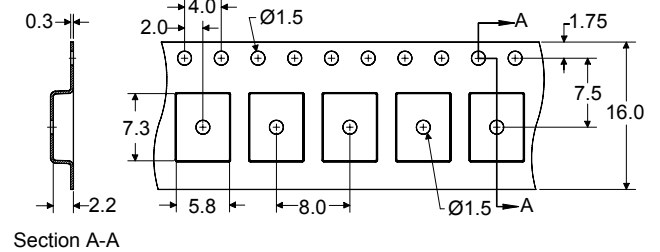
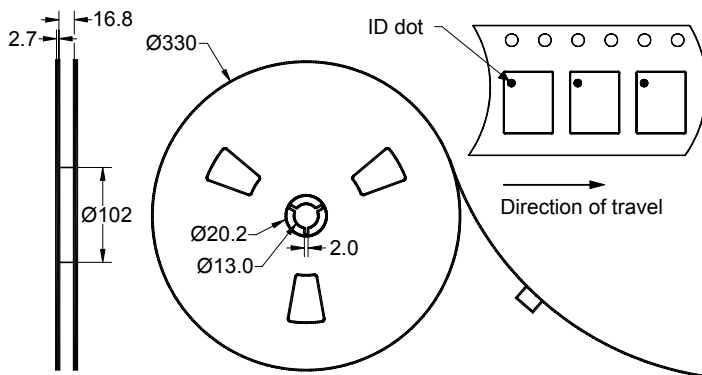

Dimensions shown are nominal in millimeters
Packaging quantity: 3000 units/reel

Data Sheet

Maximum Ratings

Parameter	Symbol	Minimum	Maximum	Unit
Operating Temperature Range	T	-10	+80	°C
Storage Temperature Range	T _{stg}	-40	+85	°C
Input Power	P _{in}	-	+15	dBm

Warnings

- Electrostatic Sensitive Device (ESD) 
- Avoid ultrasonic exposure

Links to Additional Technical Information

[PCB Layout Tips](#)

[Qualification Flowchart](#)

[Soldering Profile](#)

[S-Parameters](#)

[Other Technical Information](#)

Sawtek's liability is limited only to the Surface Acoustic Wave (SAW) component(s) described in this data sheet. Sawtek does not accept any liability for applications, processes, circuits or assemblies which are implemented using any Sawtek component described in this data sheet.

Contact Information



PO Box 609501
 Orlando, FL 32860-9501
 USA

Phone: +1 (407) 886-8860
 Fax: +1 (407) 886-7061
 Email: custservice@sawtek.com
 Web: www.sawtek.com

Or contact one of our worldwide
 network of [sales offices](#),
[representatives or distributors](#)