



SB140L SERIES

LOW VF SCHOTTKY RECTIFIER

VOLTAGE 40 to 60 Volts **CURRENT** 1 Ampere

DO-41 Unit : inch(mm)

FEATURES

- Plastic package has Underwriters Laboratory Flammability Classification 94V-O utilizing Flame Retardant Epoxy Molding Compound
- Exceeds environmental standards of MIL-S-19500/228
- For use in low voltage, high frequency inverters, free wheeling, and polarity protection applications
- Low forward voltage drop, low power loss
- In compliance with EU RoHS 2002/95/EC directives

MECHANICAL DATA

- Case: DO-41 Molded plastic
- Terminals: Axial leads, solderable per MIL-STD-750, Method 2026
- Polarity: Color band denotes cathode end
- Mounting Position: Any
- Weight: 0.0118 ounces, 0.336grams

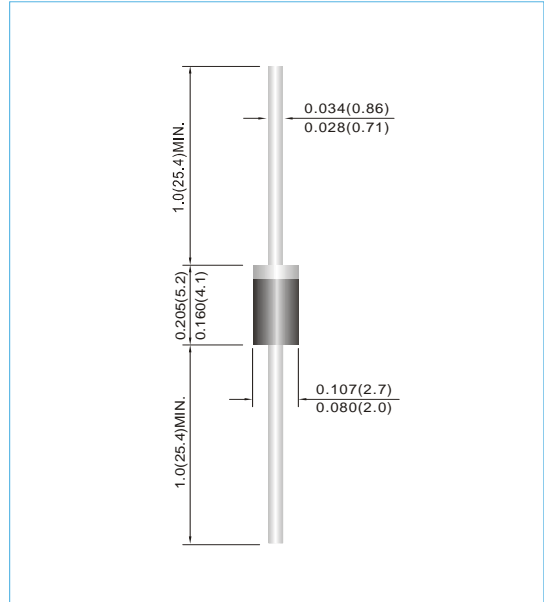

MAXIMUM RATINGS AND ELECTRICAL CHARACTERISTICS

Ratings at 25°C ambient temperature unless otherwise specified. Single phase, half wave, 60 Hz, resistive or inductive load.

PARAMETER	SYMBOL	SB140L	SB145L	SB160L	UNITS
Maximum Recurrent Peak Reverse Voltage	V_{RRM}	40	45	60	V
Maximum RMS Voltage	V_{RMS}	28	31.5	42	V
Maximum DC Blocking Voltage	V_{DC}	40	45	60	V
Maximum Average Forward Rectified Current	$I_{F(AV)}$	1			A
Peak Forward Surge Current : 8.3ms single half sine-wave superimposed on rated load (JEDEC method)	I_{FSM}	90			A
Typical Forward Voltage at 0.5A	V_F	0.37		0.39	V
Maximum Forward Voltage at 1.0A	V_F	0.45		0.50	V
Maximum DC Reverse Current at Rated DC Blocking Voltage	I_R		0.1	10	mA
Typical Thermal Resistance	$R_{\theta JA}$ $R_{\theta JL}$		70	25	°C / W
Operating Junction and Storage Temperature Range	T_J, T_{STG}	-55 to +125			°C

NOTES :

1. Thermal resistance from junction to ambient 0.375" (9.5 mm) lead length mounted on PCB with min. pad layout.
2. Thermal resistance from junction to lead at 0.375" (9.5 mm) lead length with both leads attached to heatsinks.



SB140L SERIES

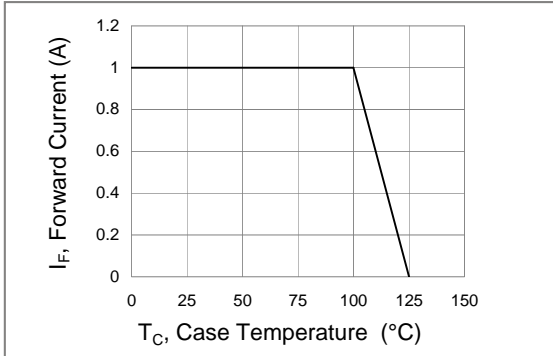

Fig.1 Forward Current Derating Curve

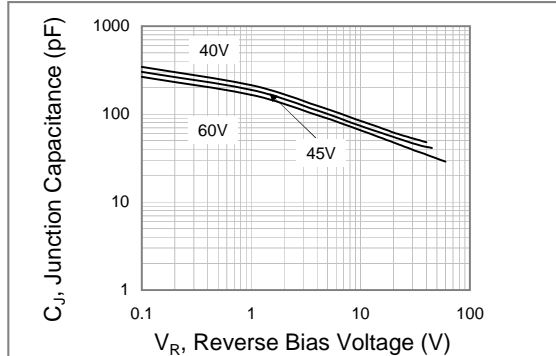

Fig.2 Typical Junction Capacitance

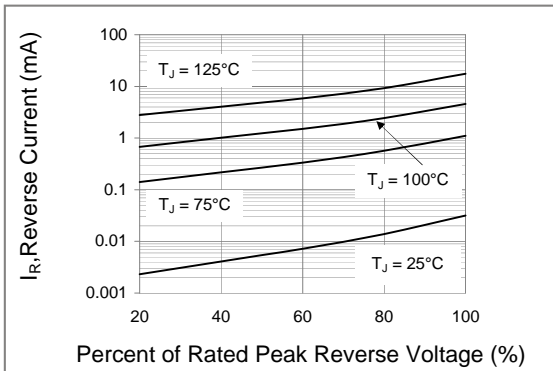

Fig.3 SB140L Typical Reverse Characteristics

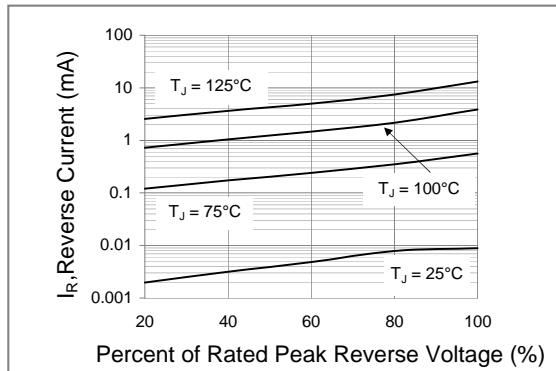

Fig.4 SB145L Typical Reverse Characteristics

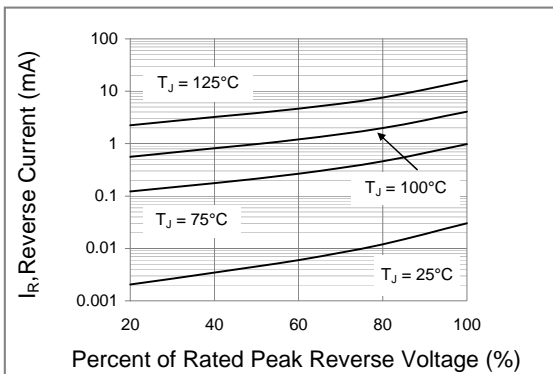

Fig.5 SB160L Typical Reverse Characteristics

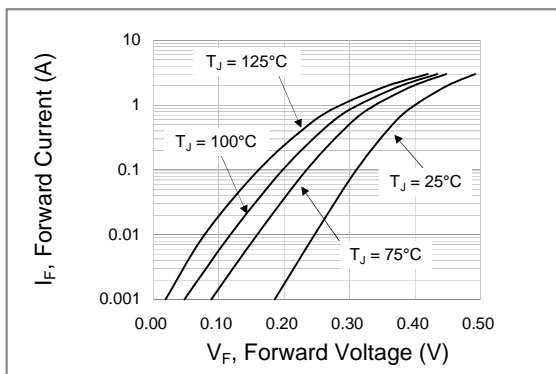

Fig.6 SB140L Typical Forward Characteristics

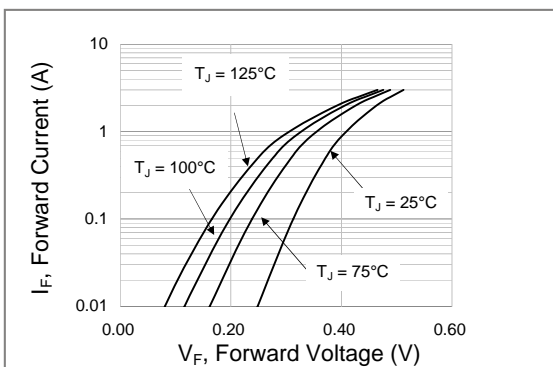

Fig.7 SB145L Typical Forward Characteristics

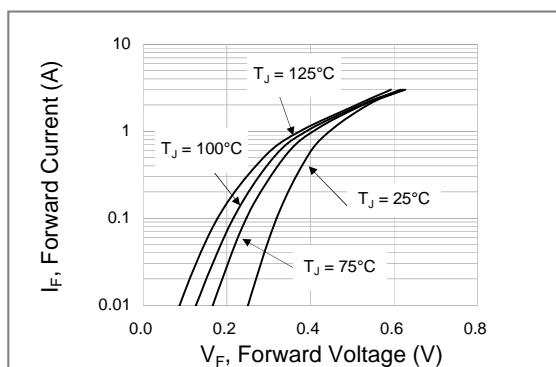

Fig.8 SB160L Typical Forward Characteristics